



ویرا پرداز آروین پاسارگاد

با مدیریت خانم مهندس احمدی



جهت مشاوره

با کارشناسان فنی

با ما در ارتباط باشید



021 - 91001377



0935 125 90 98

+ BALL BEARING UNITS



As one of the world's leading manufacturers of rolling bearings, linear technology components and steering systems, we can be found on almost every continent – with production facilities, sales offices and technology centres – because our customers appreciate short decision-making channels, prompt deliveries and local service.



Trademarks within this catalogue

All NSK product and service names listed within this catalogue are trademarks or registered trademarks of NSK Ltd.

Partnership based on trust – and trust based on quality

Total Quality by NSK: The synergies of our global network of NSK Technology Centres. Just one example of how we meet our requirements for high quality.

NSK is one of the leading companies with a long tradition in patent applications for machine parts. In our worldwide research centres, we not only concentrate on the development of new technologies, but also on the continual improvement of quality

based on the integrated technology platform of tribology, material technology, analysis and mechatronics.

More about NSK at www.nskeurope.com or call us on + (44)1636 605123



Ball Bearing Units

Content	Pages
Self-Lube Bearings	5 - 153
J-Line Bearing Units	154 - 239

Self-Lube Bearings

Content

Self-Lube	5
› Matrix	6
› Part numbering system	8
› Technical information common to all ranges	9
› Load ratios	12
› Technical specification	13
› Bearing tables	21
› Additional products	92
Silver-Lube	95
› Matrix	96
› Part numbering system	96
› Bearing tables	102
Molded-Oil – Stainless steel units	111
› Matrix	112
› Part numbering system	112
› Technical specification	113
› Bearing tables	114
Life-Lube (Molded-Oil Inserts in Silver-Lube Housings)	121
› Matrix	122
› Part numbering system	122
› Technical specification	123
› Bearing tables	126
Special Products and Bearing Solutions	137
› Additional products	138
› HLT Self-Lube	138
› Special housing options	138
Interchange list	139
› Common engineering unit conversion tables	
Conversion tables	147
› Part number interchange list	



Self-Lube General Technical Specification

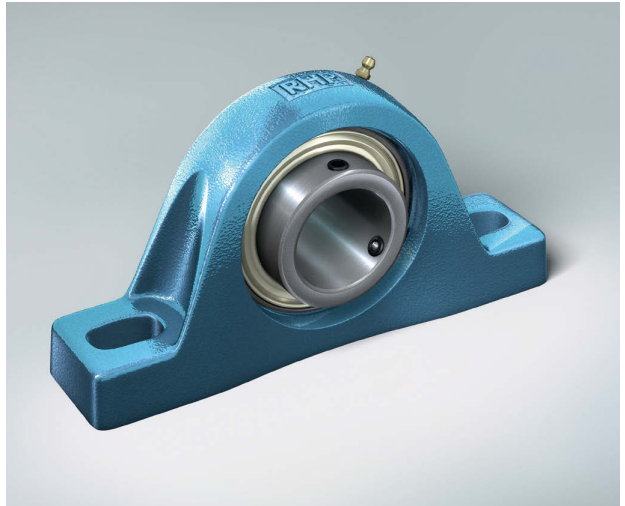

Standard unit references

Insert Type

Housing Type

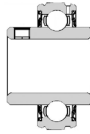

1000G

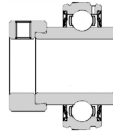

1000DECG

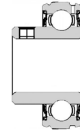

1200G

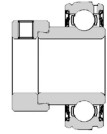

1200ECG

Cast iron one piece



Page	78	80	81	82
------	----	----	----	----

22	NP	NP-DEC	NP-A	NP-EC
-----------	----	--------	------	-------

28	SL	SL-DEC	SL-A	SL-EC
-----------	----	--------	------	-------

30	MP			
-----------	----	--	--	--



34	SNP	SNP-DEC	SNP-A	SNP-EC
-----------	-----	---------	-------	--------



34	CNP	CNP-DEC	CNP-A	CNP-EC
-----------	-----	---------	-------	--------



36	SF	SF-DEC	SF-A	SF-EC
-----------	----	--------	------	-------



38	MSF			
-----------	-----	--	--	--



42	SFT	SFT-DEC	SFT-A	SFT-EC
-----------	-----	---------	-------	--------



44	MSFT			
-----------	------	--	--	--



48	LFTC	LFTC-DEC	LFTC-A	LFTC-EC
-----------	------	----------	--------	---------



50	FC	FC-DEC	FC-A	FC-EC
-----------	----	--------	------	-------



52	MFC			
-----------	-----	--	--	--



54	ST	ST-DEC	ST-A	ST-EC
-----------	----	--------	------	-------



56	MST			
-----------	-----	--	--	--



60	BT		BT-A	BT-EC
-----------	----	--	------	-------



62	SLC	SLC-DEC	SLC-A	SLC-EC
-----------	-----	---------	-------	--------



64	MSC			
-----------	-----	--	--	--



66	SCHB			
-----------	------	--	--	--

66	SCH			
-----------	-----	--	--	--

Pressed steel two piece



68	SLFE	SLFE-DEC	SLFE-A	SLFE-EC
-----------	------	----------	--------	---------



70	SLFT	SLFT-DEC	SLFT-A	SLFT-EC
-----------	------	----------	--------	---------



72	SLFL	SLFL-DEC	SLFL-A	SLFL-EC
-----------	------	----------	--------	---------



74	LPB	LPB-DEC	LPB-A	LPB-EC
-----------	-----	---------	-------	--------



76	LPBR	LPBR-DEC	LPBR-A	LPBR-EC
-----------	------	----------	--------	---------

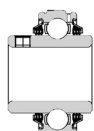

T1000G

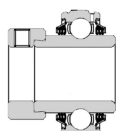

T1000DECG

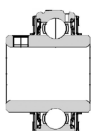

1000GFS

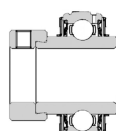

1000DECGFS

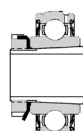

1000-KG

86	88	89	90	84	Page
TNP	TNP-DEC	NP-FS	NP-DECFS	NP1000-K	26
TSL	TSL-DEC	SL-FS	SL-DECFS		
TMP		MP-FS		MP1000-K	32
TSNP	TSNP-DEC	SNP-FS	SNP-DECFS		
TCNP	TCNP-DEC	CNP-FS	CNP-DECFS		
TSF	TSF-DEC	SF-FS	SF-DECFS		
TMSF		MSF-FS		MSF1000-K	40
TSFT	TSFT-DEC	SFT-FS	SFT-DECFS		
TMSFT		MSFT-FS		MSFT1000-K	46
TLFTC	TLFTC-DEC	LFTC-FS	LFTC-DECFS		
TFC	TFC-DEC	FC-FS	FC-DECFS		
TMFC		MFC-FS			
TST	TST-DEC	ST-FS	ST-DECFS		
TMST		MST-FS		MST1000-K	58
TBT		BT-FS			
TSLC	TSLC-DEC	SLC-FS	SLC-DECFS		
TMSC		MSC-FS			
TSCHB		SCHB-FS			
TSCH		SCH-FS			
TSLFE	TSLFE-DEC	SLFE-FS	SLFE-DECFS		
TSLFT	TSLFT-DEC	SLFT-FS	SLFT-DECFS		
TSLFL	TSLFL-DEC	SLFL-FS	SLFL-DECFS		

Standard Self-Lube insert references

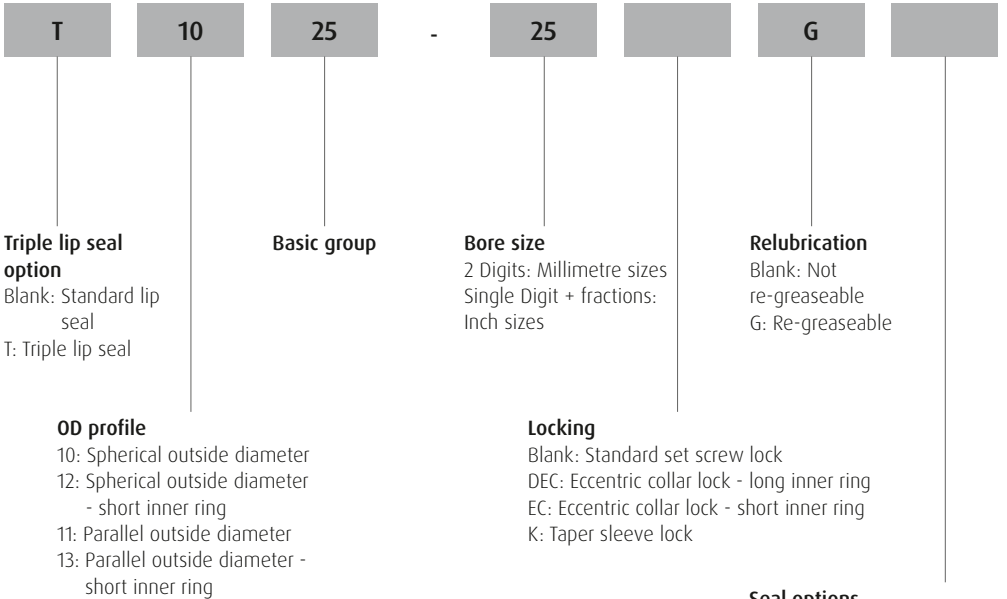

List of common prefixes and suffixes

Prefixes

- B Unit or bearing insert supplied without locking collar.
- J Grease groove on the side of the bearing insert nearest to the locking device.
- T Triple lip sealed bearing insert.

Suffixes

- A Unit fitted with set screw lock insert with flush inner ring on one side.
- C4 Radial clearance greater than C3.
- CG Parallel outside diameter insert with grease groove and snap ring fitted.
- DEC Eccentric collar lock with extended inner ring.
- DL Double locking inner ring - 4 set screws (2 each end).
- EC Eccentric collar lock with flush inner ring on one side.
- FS Bearing insert fitted with flinger seals.
- G Bearing insert having relubrication facility.
- HLT High and low temperature bearing insert.
- K Bearing insert with tapered bore.
- L Larger than normal unit for the basic bore size.
- P Housing fitted with 1/8" BSP grease nipple (standard is 1/4" UNF).
- R Smaller than normal unit for the basic bore size.

Self-Lube product range

NSK manufactures several ranges of mounted units. These include Self-Lube, our recognised standard, and recently introduced ranges such as Silver-Lube, Life-Lube and Molded-Oil units. In each type, there are two basic components, the insert and the housing.

Self-Lube bearing inserts

The Self-Lube bearing insert, commonly known as a wide inner ring bearing, is designed to suit the wide range of housings offered by NSK in the Self-Lube bearing family and is also suitable for applications where the user's own housing is preferred.

They are basically deep-groove ball bearings, to the popular 6200 series configuration, with integral design features making them more functional and versatile than standard ball bearings. The radial internal clearance is C3 for standard bearing inserts and bearings can be offered with either parallel or spherical outside diameter outer rings with the latter being the type fitted in the bearing unit. The integral design features of the bearing insert, such as shaft locking, sealing and lubrication, are explained in the following pages.

Self-Lube bearing units

The range of Self-Lube bearing units offers a wide choice of cast iron, pressed steel, synthetic rubber, thermoplastic or stainless steel housings fitted with spherical outside diameter Self-Lube bearing inserts. They will generally accommodate initial housing misalignment up to 0.030 radians but are not recommended for running misalignment in excess of 0.001 radians.

The general housing types are pillow blocks, flange units,

take-up units, cartridge units and hanger units. Choice is very much determined by the requirements of the application, although the aesthetic appearance of the machine design is often an important consideration. Self-Lube units have been designed to meet the needs of both criteria.

- ▶ Cast iron unit castings are made from high-quality cast iron, and finished on unmachined surfaces with an electrostatic air-drying paint.
- ▶ Pressed steel housings are made from mild steel strip, and are zinc plated.
- ▶ Thermoplastic housings are moulded in highgrade PBT, a high quality thermoplastic polyester resin.
- ▶ Stainless steel housings are made from austenitic stainless steel castings (SCS13).

Additional products

NSK recognises the need for 'tailor made' solutions and is always willing to help customers who have a requirement for something out of the ordinary.

Dynamic load ratings

The NSK dynamic load ratings given in this catalogue and the relationship between these and bearing fatigue life are based on ISO standard 281.

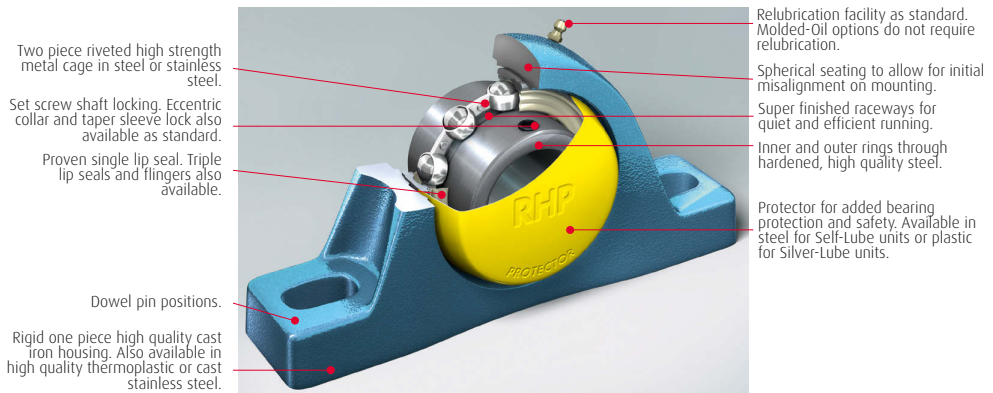

Bearing load ratings and endurance

Basic dynamic radial load rating C_r

This is defined as the load that can be applied to the bearing to give a basic L_{10} rating life of one million revolutions. This is the life associated with 90% reliability which has been found by experience to be acceptable for normal engineering bearing applications. The majority of the bearings attain a much longer life and the median life is approximately five times the L_{10} life. Ratings for each series are given in the bearing tables and are used to calculate life for radial loads of constant magnitude and direction.

Equivalent dynamic radial load P_r

For applications where axial and radial loads are present they must be converted into a single equivalent radial load P_r and calculated as follows, where:

- F_r = actual radial load (N)
- F_a = actual axial load (N)
- Y = axial factor from table 18.2
- C_{or} = basic static load rating
- C_r = dynamic radial load rating
- f_o = axial load factor

Note: Axial load F_a must not exceed $0.5 C_{or}$.
Select f_o from table 18.1 for the appropriate bearing insert.

Calculate $\frac{f_o F_a}{C_{or}}$ and obtain the value of Y from table 18.2.
Calculate P_r where:

$$P_r = F_r \quad \text{or} \\ P_r = 0.56 F_r + Y F_a$$

Use whichever P_r value is the greatest.

Relationship between load and life

Having determined the equivalent load P_r the nominal L_{10} bearing life is calculated as follows:

$$L_{10} \text{ life in hours} = \left(\frac{C_r}{P_r} \right)^3 \cdot \frac{10^6}{60n}$$

where n = bearing operating speed (rev/min).

Alternatively, by using the loading ratio $\frac{C_r}{P_r}$ the bearing L_{10} life can be estimated by reading off directly from the tables on page 12 under the appropriate speed column.

Basic static load rating C_{or}

This value is calculated in accordance with ISO standard 76. Ratings for each series are given in the bearing tables.

Static equivalent radial load P_{or}

When static axial and radial loads are applied to a bearing these must be converted to an equivalent static radial load P_{or} where:

F_r = actual static radial load (N)

F_{oa} = actual static axial load (N)

Calculate P_{or} where:

$$P_{or} = F_r \quad \text{or} \\ P_{or} = 0.6 F_r + 0.5 F_{oa}$$

Use whichever P_{or} value is greater, but this value **should not exceed** the bearing static radial load rating C_{or} .

Service factors

It is customary when calculating bearing life to include application factors which allow for fluctuations in loading that occur in service, and from experience the following may be used as a guide.

For steady and light shock loads multiply load by 1.2 to 1.5.

For moderate shock loads multiply load by 1.7 to 2.0.

When selecting the size of bearing for a given load, the calculated life should conform to the L_{10} lives shown in the next column:

- ▶ Machines in use 8 hours/day – not fully utilised – 10,000 to 20,000 hours
- ▶ Machines in use 8 hours/day – fully utilised – 20,000 to 30,000 hours.
- ▶ Machines in use 24 hours/day – 40,000 to 80,000 hours.
- ▶ Machines in seasonal use – 4,000 to 8,000 hours.

Limiting loads

The axial load F_{oa} must not exceed half the basic static load rating C_{or} . Housing strengths must also be considered as a limiting factor - see detail on page 17.

Table 18.1

Basic bearing insert	f_o
1017	13.1
1020	13.1
1025	13.9
1030	13.8
1035	13.8
1040	14.0
1045	14.1
1050	14.4
1055	14.3

Table 18.2

Basic bearing insert	f_o	$\frac{f_o F_a}{C_{or}}$	Y
1017	14.3	0.172	2.30
1020	14.4	0.345	1.99
1025	14.4	0.689	1.71
1030	14.7	1.03	1.55
1035	14.6	1.38	1.45
1040	14.7	2.07	1.31
1045	14.5	3.45	1.15
1050	13.6	5.17	1.04
1055	14.3	6.89	1.00

Examples of bearing calculations

Example 1

What nominal life can be obtained from NP55 with a steady radial load $F_r = 3900\text{N}$ at speed of 1500 rev/min? The dynamic load rating C_r of the unit from page 23 is 43500N. Since the bearing is not subject to axial load the equivalent load $P_r = F_r$ according to the formula on page 10. Therefore applying the service factor of 1.2 for a steady load.

$$P_r = F_r \cdot 1.2 = 3900 \cdot 1.2 = 4680\text{N}.$$

From page 10,
 L_{10} life in hours

$$\begin{aligned} &= \left(\frac{C_r}{P_r} \right)^3 \cdot \frac{10^6}{60 \times 60} \\ &= \left(\frac{43500}{4680} \right)^3 \cdot \frac{10^6}{1500 \times 60} \\ &= 8923 \text{ hours} \end{aligned}$$

Alternatively, using the loading ratio tables on page 12 an approximate life can be obtained by locating the nearest $\frac{C_r}{P_r}$ value in the appropriate rev/min column.

$$\text{Therefore } \frac{C_r}{P_r} = \frac{43500}{4680} = 9.29$$

Under the 1500 rev/min column the nearest $\frac{C_r}{P_r}$ value is 9.65 which gives an approximate life of 10000 hours.

Example 2

With a radial load $F_r = 2940\text{N}$ and an axial load $F_a = 1470\text{N}$ at 300 rev/min with moderate shock present, what nominal L_{10} life can be obtained from unit reference SF40? The dynamic radial load rating C_r of the unit from page 37 is 32500N and the static load rating C_{or} is 19900N. Since the bearing is subject to radial and axial loads we have to establish the equivalent load P_r according to page 10.

First, using the left hand table at the foot of page 10, we establish the value of $\frac{f_o F_a}{C_{or}}$

$$\frac{f_o F_a}{C_{or}} = \frac{14.0 \cdot 1470}{19900} = 1.03$$

Using this value in the right hand table at the foot of page 10, we establish a value for $Y = 1.55$.

From page 10 we then calculate the value of P_r
 $P_r = 2940\text{N}$

or

$$P_r = 0.56 (2940) + 1.55 (1470) = 3925\text{N}$$

Using the greater value of P_r and applying an application factor of 1.7 (page 10) for moderate shock loads:

$$\begin{aligned} P_r &= 3925 \cdot 1.7 \\ &= 6673\text{N} \end{aligned}$$

From page 10:

$$\begin{aligned} L_{10} \text{ life hours} &= \left(\frac{C_r}{P_r} \right)^3 \cdot \frac{10^6}{60n} \\ &= \left(\frac{32500}{6673} \right)^3 \cdot \frac{10^6}{60 \times 300} \\ &= 6418 \text{ hours} \end{aligned}$$

Alternatively, using the loading ratio tables on page 12, an approximate life can be obtained by locating the nearest C_r/P_r value in the appropriate rev/min column. Therefore, $C_r/P_r = 32500/6673 = 4.87$. Under the 300 rev/min column on page 12, calculated value of 4.87 is approximately mid-way between table values of 4.48 and 5.13. By interpolation, this gives an approximate life of 6250 hours.

Housing strength

To check the housing strength for example 2 when the axial load

$F_a = 1470\text{N}$ and applying an application factor of 1.7 then:
Axial load = $1470 \cdot 1.7 = 2499\text{N}$

From page 17 we see that the maximum axial loads for the above unit are:

0.45 C_{or} in one direction, and

0.25 C_{or} in the opposite direction.

Calculating these two maximum axial loads that may be applied to housing:

$$0.45 \cdot 19900 = 8955\text{N}$$

$$0.25 \cdot 19900 = 4975\text{N}$$

From the above it can be seen that the housing will support the axial load of 2499N in either direction. Therefore, the unit above is satisfactory for the loading conditions stated.

Note It is advisable to shoulder the shaft for high axial loads.

Loading ratios

Life estimation for ball bearings for different C_r/P_r ratios and speeds

L_{10} life (hours)	Speed: rev/min								
	25	50	100	150	200	300	500	750	1000
100					1.06	1.22	1.45	1.65	1.82
500		1.14	1.45	1.65	1.82	2.08	2.47	2.82	3.11
1000	1.14	1.44	1.82	2.08	2.29	2.62	3.11	3.56	3.91
1500	1.31	1.65	2.08	2.38	2.62	3.00	3.56	4.07	4.48
2000	1.45	1.82	2.29	2.62	2.88	3.30	3.91	4.48	4.93
3000	1.65	2.08	2.62	3.00	3.30	3.78	4.48	5.13	5.65
5000	1.96	2.47	3.11	3.56	3.91	4.48	5.32	6.08	6.70
7500	2.24	2.82	3.56	4.07	4.48	5.13	6.08	6.96	7.66
10000	2.47	3.11	3.91	4.48	4.93	5.65	6.70	7.66	8.43
19500	2.82	3.56	4.48	5.13	5.65	6.46	7.66	8.77	9.65
20000	3.11	3.91	4.93	5.65	6.21	7.11	8.43	9.65	10.60
30000	3.56	4.48	5.65	6.46	7.11	8.14	9.65	11.10	12.20
40000	3.91	4.93	6.21	7.11	7.81	8.96	10.60	12.20	13.40
60000	4.48	5.65	7.11	8.14	8.96	10.30	12.20	13.90	15.30
80000	4.93	6.21	7.81	8.96	9.83	11.30	13.40	15.30	16.80

Life estimation for ball bearings for different C_r/P_r ratios and speeds

L_{10} life (hours)	Speed: rev/min								
	1500	2000	3000	4000	5000	6000	8000	10000	
100	2.08	2.29	2.62	2.88	3.11	3.30	3.63	3.91	
500	3.56	3.91	4.48	4.93	5.32	5.65	6.21	6.69	
1000	4.48	4.93	5.65	6.21	6.70	7.11	7.81	8.43	
1500	5.13	5.65	6.46	7.11	7.65	8.15	8.96	9.65	
2000	5.65	6.21	7.11	7.81	8.43	8.96	9.83	10.60	
3000	6.46	7.11	9.14	8.96	9.65	10.30	11.30	12.20	
5000	7.66	8.43	9.65	10.60	11.50	12.20	13.40	14.40	
7500	8.77	9.65	11.10	12.20	13.10	13.90	15.30	16.50	
10000	9.65	10.60	12.20	13.40	14.50	15.30	16.80	18.20	
19500	11.10	12.20	13.90	15.30	16.50	17.50	19.30	20.80	
20000	12.20	13.40	15.30	16.80	18.50	19.30	21.20	22.90	
30000	13.90	15.30	17.50	19.30	20.80	22.10	24.30	26.20	
40000	15.30	16.80	19.30	12.20	22.90	24.30	26.70	28.80	
60000	17.50	19.30	22.10	14.30	26.20	27.80	30.70	33.00	
80000	19.30	21.20	24.30	16.70	28.80	30.70	33.70	36.30	

Self-Lube product range

Under the heading of Self-Lube bearings there are two basic products: The Self-Lube bearing insert and the Self-Lube bearing unit.

Self-Lube bearing unit

The range of Self-Lube bearing units offers a wide choice of cast iron, pressed steel or synthetic rubber housings fitted with the full range of spherical outside diameter Self-Lube bearing inserts. They will accommodate initial housing misalignment up to 0.030 radians but are not recommended for running misalignment in excess of 0.001 radians.

The general housing types are pillow blocks, flange units, take-up units, cartridge units and hanger units. Choice is very much determined by the requirements of the application, although the aesthetic appearance of the machine design is often an important consideration. Self-Lube units have been designed to meet the needs of both criteria.

The castings are made from high-quality cast iron, and finished on unmachined surfaces with an electrostatic air-drying paint.

Pressed steel housings are made from mild steel strip, and are zinc plated. Rubber housings are moulded in antistatic nitrile rubber.

Self-Lube Protector

The Self-Lube Protector is designed to protect the machine operator from the dangers of rotating shaft ends and the external surfaces of the bearing from contamination.

The protector is made from good quality mild steel and coated with enamel paint making it robust, attractive and long lasting. It is easy to fit and can be removed without breakage or deformation thus allowing it to be refitted time after time.

Standard Self-Lube inserts with spherical outside diameters have a 'groove' in the outer ring on the opposite side from the grease groove. The protector has two claws which locate through the casting loading slots into the 'groove' in the outer ring. This provides a very secure lock and makes the Protector difficult to dislodge. The user of Self-Lube units is not required to purchase special bearings or provide any additional locking device in order to obtain this secure safety feature.

The Protector can be removed by inserting a form of lever device into a small hole in one of the claws and exerting slight pressure outwards. This disengages the claw from the outer ring 'groove'. A replaceable cover for the hole is provided.



Sealing and Lubrication

Relubrication of Self-Lube Bearings

NSK Self-Lube Bearings are factory charged with the correct amount of grease and do not require a further grease charge when being fitted.

Relubrication is not normally necessary except when operating at extremes of temperature, speed and loading, or where excessive wet or dirty conditions exist.

The relubrication frequency varies with the type and quality of grease used as well as the operating conditions. Therefore, it is difficult to establish a general rule, but under ordinary operating conditions, it is desirable that grease be replenished before one third (1/3) of its calculated life elapses. It is necessary, however, to take into consideration such factors as hardening of grease in the oil hole, making replenishment impossible, or deterioration of grease due to oxidation while the machine is running.

The table shows standard relubrication frequencies. Irrespective of the calculated life of the grease, this list takes into consideration such factors as the rotational speed of the bearings, operating temperatures and environmental conditions, with a view to safety.

The performance of a bearing is greatly influenced by the quantity of grease. In order to avoid overfilling, it is advisable to replenish the grease while the machine is in operation. Continue to insert grease until a little oozes out from beneath the sealing lip on the inner ring for optimum performance.

All standard Self-Lube bearing units have 1/4"-28UNF grease nipples, except for the FC series units which have M5 x 0.8mm pitch grease nipples.

Lubrication

Unit	Unit temperature range	Grease	Supplier
Standard insert	-20°C to +110°C	Alvania S2	Shell
HLT insert	-40°C to +180°C	Kluberquiet BQH72-102	Kluber

Standard relubrication frequencies

Type of unit	dn Value	Environmental conditions	Operating temp °C, °F		Relubrication frequency	
			°C	°F	Hours	Period
Standard	40000 and below	Ordinary	-15 to +80	+5 to +176	1500 to 3000	6 to 12 mo.
Standard	70000 and below	Ordinary	-15 to +80	+5 to +176	1000 to 2000	3 to 6 mo.
Standard	70000 and below	Ordinary	+80 to +100	+176 to +212	500 to 700	1 mo.
HLT	70000 and below	Ordinary	+100 to +130	+212 to +266	300 to 700	1 mo.
HLT	70000 and below	Ordinary	+130 to +180	+266 to +356	100 to 300	1 wk.
HLT	70000 and below	Ordinary	-60 to +80	-76 to +176	1000 to 2000	3 to 6 mo.
Standard	70000 and below	Very dusty	-15 to +100	+5 to +212	100 to 500	1 wk. to 1 mo.
Standard	70000 and below	Exposed to water splashes	-15 to +100	+5 to +212	30 to 100	1 day to 1 wk.

dn = bore diameter (mm) · speed (rpm)

Single Lip Seal

The S-type seal, which is firmly secured in the bearing outer ring, comprises a nitrile rubber sealing element (black in colour) bonded to a strong steel former. The flexible sealing lip contacts the fine ground finish of the inner ring to give low friction with effective sealing.

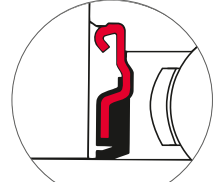

Single lip seal (standard)

Flinger seal

Where extra protection is required without loss of bearing catalogue speed, the 'Flinger seal' is ideal. It consists of a steel flange to which is bonded a flexible nitrile sealing lip. They are offered for the 1000G and 1000DECG types and are identified with the suffix FS (e.g. 1025-25GFS, NP25FS). The flinger is fitted to the inner ring.

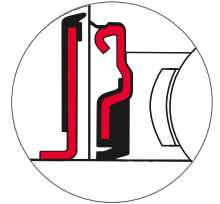

Single lip seal + flinger seal

Triple lip seal

For applications with a high degree of contamination, the specially developed RHP triple lip seal is recommended. It consists of a one-piece moulded nitrile seal with three sealing lips, bonded to a protective steel outer pressing which is strongly secured in the outer ring making a highly efficient sealing arrangement. It is not recommended for high speeds. See pages 86 to 88.

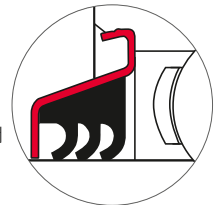

Triple lip seal

Shaft locking arrangements

Set screw lock

This locking arrangement consists of two knurled cup-point, self-locking, socket-head set screws fitted in the extended inner ring.

For normal loads and moderate speeds simply mount the bearing unit into position and tighten down the set screws to the recommended torque value.

Additional security can be achieved by spot drilling the shaft to accommodate the set screw point. When spot drilling, first remove the set screw and locate the position on the shaft. Select a drill the size of the inner ring threads minor diameter, and drill through this hole into the shaft to the depth of the drill point.

Replace the set screw and tighten onto the shaft in the normal manner.

The recommended tightening torques for the set screws are given on page 16.

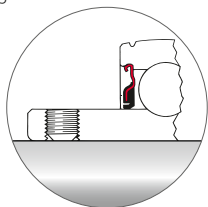

Set screw lock

Eccentric collar lock

This type of lock consists of an eccentric diameter formed on the extended inner ring of the bearing which engages a similarly formed eccentric diameter in the bore of a separate collar. Locking is achieved by turning the collar in the direction of the shaft rotation until the eccentric diameters of both collar and inner ring are fully engaged. The collar is provided with a blind hole to facilitate tightening when locking the bearing to the shaft. The set screw when tightened to the recommended torque values on page 16 prevents the collar 'backing off' in service.

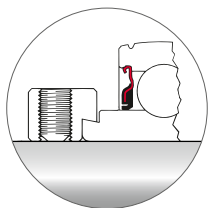

Eccentric collar lock

Taper sleeve lock

This locking arrangement, which incorporates a standard taper adapter sleeve, locknut and lock washer, is recommended when a positive concentric (shaft) lock is required.

When fitting the bearing to the shaft, care must be taken to ensure that the locknut is not over-tightened as this can eliminate the bearing internal clearance, resulting in premature failure. A lockwasher is provided which prevents the locknut 'backing off' when one of the tabs is engaged with the corresponding notch in the locknut. (See below for fitting instructions).

The recommended tightening torques for the locknuts are given on page 16.

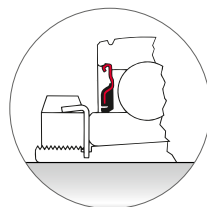

Taper sleeve lock

Mounting Self-Lube adapter sleeve units

- › First bolt the Self-Lube housing to the equipment and clean the shaft and sleeve bore of any oil or grease.
- › Position the shaft within the unit and tighten up the locknut by hand. If the sleeve assembly turns on the shaft tap the sleeve into the bearing to give a positive grip. Tighten locknut to recommended torque value given on page 16.
- › Where torque spanner facilities are not available a blunt drift and small hammer may be used to tighten the nut.
- › Check that the bearing rotates freely, to ensure that the internal clearance has not been totally removed and that preload has been avoided.
- › Finally, secure the nut with the appropriate tab on the locking washer. Tighten the nut slightly if necessary but never back the nut off.
- › After 100 hours running it is advisable to check the tightness of the locknut.

Set screw thread and tightening torques

Set screw thread and size

Basic bearing insert reference	Series			
	1000G, 1100, 1200G, 1300		1000DECG, 1100DEC, 1200ECG, 1300EC	
	Inch bore diameters	Metric bore diameters	Inch bore diameters	Metric bore diameters
1017	¼UNF	M6 x 0.75	¼UNF	M6 x 0.75
1020	¼UNF	M6 x 0.75	¼UNF	M6 x 0.75
1025	¼UNF	M6 x 0.75	¼UNF	M6 x 0.75
1030	¼UNF	M6 x 0.75	¼UNF	M6 x 0.75
1035	⅜UNF	M8 x 1.00	⅜UNF	M8 x 1.00
1040	⅜UNF	M8 x 1.00	⅜UNF	M8 x 1.00
1045	⅜UNF	M8 x 1.00	⅜UNF	M8 x 1.00
1050	⅝UNF	M10 x 1.25	⅝UNF	M10 x 1.25
1055	⅝UNF	M10 x 1.25	⅝UNF	M10 x 1.25
1060	⅝UNF	M10 x 1.25	⅝UNF	M10 x 1.25
1065	⅝UNF	M10 x 1.25	⅝UNF	M10 x 1.25
1070	7⁄16UNF	M12 x 1.50	7⁄16UNF	M12 x 1.50
1075	7⁄16UNF	M12 x 1.50	7⁄16UNF	M12 x 1.50
1080	7⁄16UNF	M12 x 1.50	-	-
1085	7⁄16UNF	M12 x 1.50	-	-
1090	½UNF	M12 x 1.50	-	-
3095	⅝UNF	M16 x 1.50	-	-

Set screw tightening torques and maximum axial loads

Set screw size	Socket/Allen key size (across flats)	Recommended maximum tightening torque		Set screw maximum axial load	
		newton metres (Nm)	lbf-inches	newtons (N)	lbf
¼UNF	⅛"	6.8	60	2500	560
⅜UNF	⅜"	12.4	110	3500	785
⅝UNF	⅜"	22.6	200	4500	1010
7⁄16UNF	7⁄32"	31.6	280	7500	1685
½UNF	¼"	45.2	400	9000	2025
⅝UNF	⅜"	53.9	477	15000	3370
M6 x 0.75	3mm	5.7	50	2500	560
M8 x 1.00	4mm	12.4	110	3500	785
M10 x 1.25	5mm	27.1	240	5000	1235
M12 x 1.50	6mm	38.4	340	8000	1800
M16 x 1.50	8mm	53.9	477	15000	3370

Note: For axial loads in excess of the values listed a shouldered shaft against the face of the inner ring is recommended.

Recommended tightening torques for adapter sleeve units

Sleeve bore size	Tightening torques	
	Nm	lbf-inches
20mm, ¾"	30	265
25mm, 15⁄16", 1"	40	355
30mm, 1½", 13⁄16"	50	440
35mm, 1¼", 13⁄16"	60	530
40mm, 17⁄16", 1½"	65	575
45mm, 111⁄16", 13⁄4"	75	660
50mm, 115⁄16", 2"	85	750

Mounting instructions for Self-Lube bearing units

Self-Lube set screw locking arrangement units

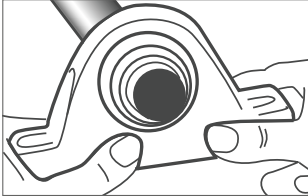

1. Relieve set screws clear of the bore and slide bearing onto the shaft.

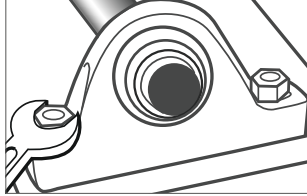

2. Bolt the unit down on to a flat surface but do not over-tighten.

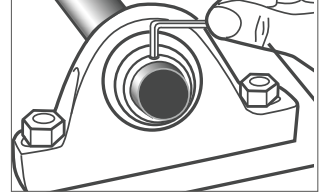

3. Tighten set screws to recommended torque

Self-Lube eccentric collar locking arrangements units

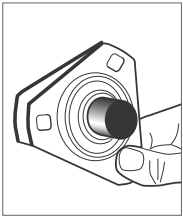

1. Assemble bearing and housing and slide onto the shaft. Do not engage collar.

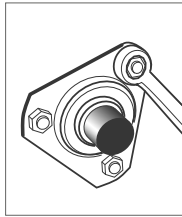

2. Lightly tighten bolts, repeat at other end of shaft and then finally tighten bolts on both sides.

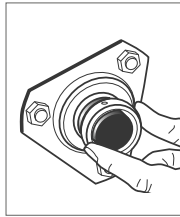

3. Engage the eccentric collar in direction of shaft rotation.

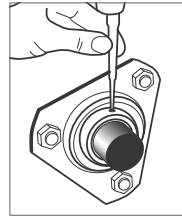

4. Tighten collar with drift pin and small hammer.

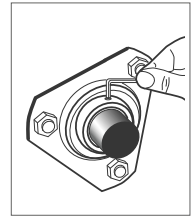

5. Tighten collar set screw to recommended torque.

Maximum recommended steady housing loads

The maximum loads shown adjacent are given as a proportion of the static load rating (C_{0r}) of the bearing insert. Where the value of the axial load exceeds the set screw maximum axial holding load listed on page 16, a shoulder on the shaft must be provided against the face of the inner ring.

For shock load conditions additional safety factors must be applied.

Housing strength limits

Radial Loads Axial loads

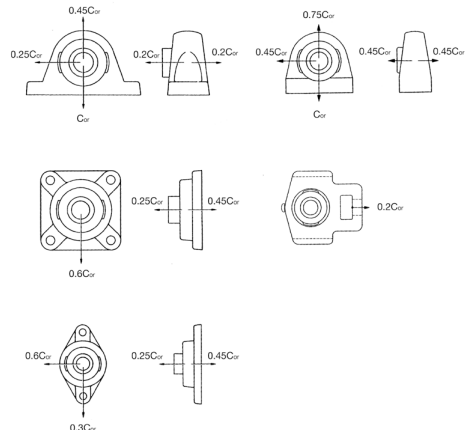

Tolerances and speeds

Inner ring bore tolerances - Set screw and eccentric collar types

Nominal bore diameter d				Tolerances			
mm above	incl.	inch above	incl.	0.001mm units		0.0001 inch units	
				high	low	high	low
10	18	0.3937	0.7087	+15	0	+6	0
18	31.750	0.7087	1.2500	+18	0	+7	0
31.750	50.800	1.2500	2.0000	+21	0	+8	0
50.800	80	2.0000	3.1496	+24	0	+9	0
80	100	3.1496	3.9370	+28	0	+11	0

Outer ring outside diameter tolerances

Nominal outside diameter d		Outside Diameter Tolerances				Width Tolerances					
mm above	incl.	0.001mm units		0.0001 inch units		Nominal bearing bore		0.001mm units		0.0001 inch units	
		high	low	high	low	mm above	including	high	low	high	low
30	50	0	-11	0	-4	9	18	0	-120	0	-47
50	80	0	-13	0	-5	18	30	0	-120	0	-47
80	120	0	-15	0	-6	30	50	0	-120	0	-47
120	150	0	-18	0	-7	50	80	0	-150	0	-59
150	180	0	-25	0	-10	80	120	0	-200	0	-78
180	250	0	-30	0	-12	-	-	-	-	-	-

Housing tolerances for parallel outside diameter inserts - series 1100, 1100DEC, 1300 and 1300EC

Nominal housing bore	Stationary outer ring Housing tolerance ISO H7				Rotating outer ring Housing tolerance ISO N7			
	0.001mm units		0.0001 inch units		0.001mm units		0.0001 inch units	
	high	low	high	low	high	low	high	low
40	+25	0	+10	0	-8	-33	-3	-13
47	+25	0	+10	0	-8	-33	-3	-13
52	+30	0	+12	0	-9	-39	-4	-15
62	+30	0	+12	0	-9	-39	-4	-15
72	+30	0	+12	0	-9	-39	-4	-15
80	+30	0	+12	0	-9	-39	-4	-15
85	+35	0	+14	0	-10	-45	-4	-18
90	+35	0	+14	0	-10	-45	-4	-18
100	+35	0	+14	0	-10	-45	-4	-18
110	+35	0	+14	0	-10	-45	-4	-18
120	+35	0	+14	0	-10	-45	-4	-18
125	+40	0	+16	0	-12	-52	-5	-20
130	+40	0	+16	0	-12	-52	-5	-20
140	+40	0	+16	0	-12	-52	-5	-20
150	+40	0	+16	0	-12	-52	-5	-20
160	+40	0	+16	0	-12	-52	-5	-20

Shaft tolerances and permissible speeds

Basic bearing insert	Shaft dia.		Max speed rev/min	High loads - high speeds				Max speed rev/min	Normal applications				Max speed rev/min	Light loads - low speeds			
	mm	inches		Shaft tolerance ISO h6					Shaft tolerance ISO h7					Shaft tolerance ISO h9			
				0.001mm units		0.0001 inch units			0.001mm units		0.0001 inch units			0.001mm units		0.0001 inch units	
high	low	high	low	high	low	high	low	high	low	high	low	high	low	high	low		
1017	12-17	½-1⅞	7000	0	-11	0	-4	5000	0	-18	0	-7	2000	0	-43	0	-17
1020	20	¾	6700	0	-13	0	-5	4200	0	-21	0	-8	1700	0	-52	0	-20
1025	25	1⅜-1	6250	0	-13	0	-5	3600	0	-21	0	-8	1350	0	-52	0	-20
1030	25-30	⅞-1¼	5300	0	-13	0	-5	3100	0	-21	0	-8	1100	0	-52	0	-20
1035	30-35	1½-1⅞	4500	0	-16	0	-6	2700	0	-25	0	-10	900	0	-62	0	-24
1040	35-40	1⅜-19/16	4000	0	-16	0	-6	2400	0	-25	0	-10	750	0	-62	0	-24
1045	40-45	1½-1¾	3700	0	-16	0	-6	2200	0	-25	0	-10	600	0	-62	0	-24
1050	45-50	1½-2	3400	0	-16	0	-6	1950	0	-25	0	-10	500	0	-62	0	-24
1055	50-55	1⅞-2⅜	3100	0	-19	0	-7	1800	0	-30	0	-12	450	0	-74	0	-29
1060	55-60	2⅞-27/16	2800	0	-19	0	-7	1600	0	-30	0	-12	400	0	-74	0	-29
1065	65	2½	2600	0	-19	0	-7	1500	0	-30	0	-12	350	0	-74	0	-29
1070	60-70	1⅞-2⅞	2450	0	-19	0	-7	1400	0	-30	0	-12	300	0	-74	0	-29
1075	65-75	2⅞-2⅞	2300	0	-19	0	-7	1300	0	-30	0	-12	280	0	-74	0	-29
1080	75-80	2⅞-3¼	2150	0	-19	0	-7	1200	0	-30	0	-12	250	0	-74	0	-29
1085	80-85	3⅞-3⅞	2000	0	-22	0	-9	1100	0	-35	0	-14	220	0	-87	0	-34
1090	85-90	3⅞-3½	1900	0	-22	0	-9	1050	0	-35	0	-14	200	0	-87	0	-34
3095	95-100	3 ⅞-4	1600	0	-22	0	-9	1000	0	-35	0	-14	180	0	-87	0	-34

For most applications the standard set screw lock is more than satisfactory. Whenever eccentric collar units are used it is recommended that shaft tolerances in the high loads column be adopted. Whenever taper adapter sleeve locking arrangements are used, shaft tolerances in the light loads column can be adopted. When operating conditions are very severe (for example, in case of heavy vibration or shock) a light interference fit may be required between the shaft and bearing bore diameter.

Housing tolerances for bearing units - series FC, MFC, SLC and MSC

Bearing unit reference	Housing tolerance	
	Stationary housing	Rotating housing
SLC MSC	ISO H7	ISO N7
FC MFC	ISO H7	ISO H7

Radial Internal Clearance (RIC)

Radial Internal Clearance	Bearing Type
C3	Standard Self-Lube bearing series
C4	Taper Sleeve Locking bearing series
C5	HLT bearing series



Self-Lube Bearing Tables



Self-Lube cast iron pillow block units

NP Series

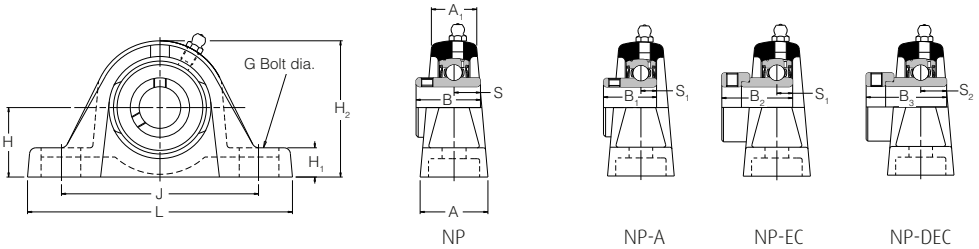

Shaft diameter mm inches	RHP designation				Basic bearing insert	Casting group	Dimensions (mm)				Bolt centres	
	L	H	H1	H2			J _{max}	J _{min}				
12	NP12		NP12EC		1017	1	126.5	30.20	14.2	57.2	100.5	85.5
15	NP15		NP15EC									
16	NP16		NP16EC									
17	NP17		NP17EC									
1/2	NP1/2		NP1/2EC									
3/8	NP3/8		NP3/8EC									
20	NP20	NP20A	NP20EC	NP20DEC	1020	2	127.0	33.30	14.0	65.2	100.5	88.5
3/4	NP3/4	NP3/4A	NP3/4EC	NP3/4DEC								
25	NP25	NP25A	NP25EC	NP25DEC	1025	3	139.0	36.50	16.0	71.0	112.7	96.8
7/8	NP7/8		NP7/8EC	NP7/8DEC								
15/16	NP15/16		NP15/16EC	NP15/16DEC								
1	NP1	NP1A	NP1EC	NP1DEC								
30	NP30	NP30A	NP30EC	NP30DEC	1030	4	160.5	42.90	17.7	82.7	129.5	108.5
1 1/8	NP1 1/8		NP1 1/8EC	NP1 1/8DEC								
1 3/16	NP1 3/16		NP1 3/16EC	NP1 3/16DEC								
1 1/4	NP1 1/4R	NP1 1/4AR	NP1 1/4ECR	NP1 1/4DEC R								
35	NP35	NP35A	NP35EC	NP35DEC	1035	5	166.0	47.60	17.5	93.0	136.5	121.5
1 1/4	NP1 1/4	NP1 1/4A	NP1 1/4EC	NP1 1/4DEC								
1 3/8	NP1 3/8		NP1 3/8EC	NP1 3/8DEC								
1 7/16	NP1 7/16		NP1 7/16EC	NP1 7/16DEC								
40	NP40	NP40A	NP40EC	NP40DEC	1040	6	180.5	49.20	18.5	98.5	148.0	127.0
1 1/2	NP1 1/2	NP1 1/2A	NP1 1/2EC	NP1 1/2DEC								
45	NP45	NP45A	NP45EC	NP45DEC	1045	7	190.5	54.00	20.0	108.0	154.5	140.5
1 3/8	NP1 3/8		NP1 3/8EC	NP1 3/8DEC								
1 11/16	NP1 11/16		NP1 11/16EC	NP1 11/16DEC								
1 3/4	NP1 3/4	NP1 3/4A	NP1 3/4EC	NP1 3/4DEC								
50	NP50	NP50A	NP50EC	NP50DEC	1050	8	206.0	57.20	21.0	115.2	163.0	154.0
1 7/8	NP1 7/8		NP1 7/8EC	NP1 7/8DEC								
1 15/16	NP1 15/16		NP1 15/16EC	NP1 15/16DEC								
2	NP2R			NP2DEC R								
55	NP55			NP55DEC	1055	9	219.5	63.50	24.8	129.5	178.5	162.5
2	NP2			NP2DEC								
2 1/8	NP2 1/8			NP2 1/8DEC								
2 3/16	NP2 3/16			NP2 3/16DEC								
60	NP60			NP60DEC	1060	10	240.0	69.90	26.3	142.3	201.0	176.0
2 1/4	NP2 1/4			NP2 1/4DEC								
2 3/8	NP2 3/8			NP2 3/8DEC								
2 1/2	NP2 1/2			NP2 1/2DEC								

Please check availability

Bearing inserts with flinger seals shown on pages 89 and 90 can be fitted into these housings. The unit reference has the suffix 'FS', e.g. NP40FS.

Triple seal bearing inserts shown on pages 86 to 88 can be fitted into these housings. The unit reference has a prefix 'T', e.g. TNP25.

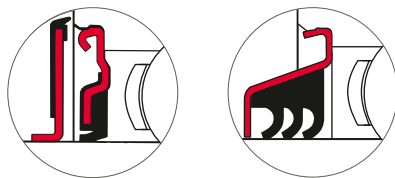

Dimensions (mm)										ISO Load ratings		Rec. max. speed rev/min	Mass (approx.) kg
G	A	A1	B	B1	B2	B3	s	s1	s2	dynamic Cr newtons	static Cor newtons		
10	30.5	20.5	27.38	-	28.63	-	11.58	6.53	-	9550	4800	7000	0.5
10	32.5	22.5	31.00	25.80	31.03	43.73	12.73	7.53	17.13	12800	6650	6700	0.6
10	36.5	24.5	34.10	27.30	31.03	44.43	14.33	7.53	17.53	14000	7880	6250	0.7
12	41.5	27.5	38.10	31.20	35.73	48.43	15.93	9.03	18.33	19500	11300	5300	1.3
12	44.5	30.5	42.90	34.90	38.93	51.13	17.53	9.53	18.83	25700	15300	4500	1.7
12	51.0	34.5	49.20	41.20	43.73	56.33	19.03	11.03	21.43	32500	19900	4000	2.1
12	54.0	35.0	49.20	41.20	43.73	56.33	19.04	11.04	21.43	32500	20500	3700	2.8
16	55.0	36.0	51.60	43.50	43.73	62.73	19.04	11.04	24.64	35000	23200	3400	3.2
16	60.0	39.5	55.60	-	-	71.42	22.24	-	27.84	43500	29200	3100	4.0
16	70.0	46.0	65.10	-	-	77.84	25.44	-	31.04	48000	33000	2800	5.9

Self-Lube cast iron pillow block units

NP Series (continued)

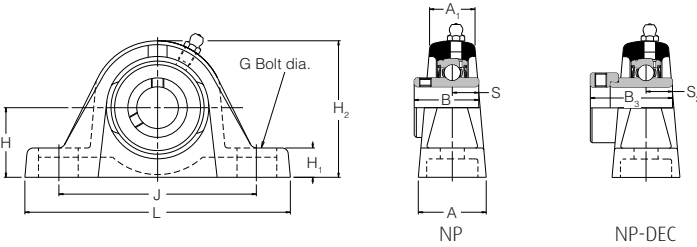

Shaft diameter		RHP designation		Basic bearing insert	Casting group	Dimensions (mm)				Bolt centres	
mm	inches					L	H	H1	H2	J _{max}	J _{min}
65		NP65	NP65DEC	1065	10/65	250.0	69.90	26.3	144.3	205.0	176.0
	2½	NP2½	NP2½DEC								
70		NP70	NP70DEC	1070	11	266.0	79.40	30.2	156.0	220.0	200.0
	2⅞	NP2⅞	NP2⅞DEC								
75		NP75	NP75DEC	1075	12	275.0	82.60	28.0	164.0	228.0	206.0
	2¾	NP2¾	NP2¾DEC								
	2⅞	NP2⅞	NP2⅞DEC								
	2⅞	NP2⅞	NP2⅞DEC								
	3	NP3	NP3DEC								
80		NP80	NP80DEC	1080	13	291.0	88.90	30.0	174.0	241.0	214.0
	3	NP3L	NP3LDEC								
85		NP85	NP85DEC	1085	14	310.0	95.20	32.0	187.0	262.0	232.0
	3¼	NP3¼	NP3¼DEC								
	3⅞	NP3⅞	NP3⅞DEC								
90		NP90	NP90DEC	1090	15	327.0	101.60	36.0	200.0	280.0	244.0
	3⅞	NP3⅞	NP3⅞DEC								
	3⅞	NP3⅞	NP3⅞DEC								
	3½	NP3½	NP3½DEC								

Please check availability

Dimensions (mm)										ISO Load ratings		Rec. max. speed rev/min	Mass (approx.) kg
G	A	A1	B	B1	B2	B3	s	s1	s2	dynamic Cr newtons	static Cor newtons		
16	70.0	45.0	65.10	-	-	85.74	25.44	-	34.14	57500	40000	2600	5.9
24	72.0	47.0	74.60	-	-	85.74	30.24	-	34.14	61000	45000	2450	8.0
24	74.0	48.0	77.80	-	-	92.14	33.34	-	37.34	66000	49500	2300	9.0
24	78.0	56.0	82.60	-	-	-	33.34	-	-	71500	54500	2150	9.7
24	83.0	56.0	85.70	-	-	-	34.15	-	-	83000	64000	2000	11.8
24	88.0	62.0	96.00	-	-	-	39.74	-	-	96000	71500	1900	14.7

Self-Lube cast iron pillow block units with adapter sleeves

NP1000-K Series

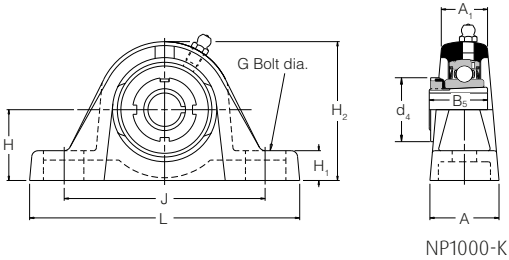

Shaft diameter		RHP designation complete unit	Sleeve nut & lockwasher only	Unit without sleeve, nut & lockwasher	Basic bearing insert	Casting group	Dimensions (mm)				Bolt centres	
							L	H	H1	H2	J _{max}	J _{min}
mm	inches											
20		NP1025-20K	H305	NP1025K	1025	3	139 ^a	36.50	16.0	71.0	112.7	96.8
	3/4	NP1025-3/4K	HE305-3/4									
25		NP1030-25K	H306	NP1030K	1030	4	160.5	42.90	17.7	82.7	129.5	108.5
	15/16	NP1030-15/16K	HE306-15/16									
	1	NP1030-1K	HE306-1									
30		NP1035-30K	H307	NP1035K	1035	5	166.0	47.60	17.5	93.0	136.5	121.5
	1 1/8	NP1035-1 1/8K	HE307-1 1/8									
	1 3/16	NP1035-1 3/16K	HE307-1 3/16									
35		NP1040-35K	H308	NP1040K	1040	6	180.5	49.20	18.5	98.5	148.0	127.0
	1 1/4	NP1040-1 1/4K	HE308-1 1/4									
	1 3/8	NP1040-1 3/8K	HE308-1 3/8									
40		NP1045-40K	H309	NP1045K	1045	7	190.5	54.00	20.0	108.0	154.5	140.5
	1 7/16	NP1045-1 7/16K	HE309-1 7/16									
	1 1/2	NP1045-1 1/2K	HE309-1 1/2									
45		NP1050-45K	H310	NP1050K	1050	8	206.0	57.20	21.0	115.2	163.0	154.0
	1 11/16	NP1050-1 11/16K	HE310-1 11/16									
	1 3/4	NP1050-1 3/4K	HE310-1 3/4									
50		NP1055-50K	H311	NP1055K	1055	9	219.5	63.50	24.8	129.5	178.5	162.5
	1 9/16	NP1055-1 9/16K	HE311-1 9/16									
	2	NP1055-2K	HE311-2									

Please check availability

Dimensions (mm)					ISO Load ratings		Rec. max. speed rev/min	Mass (approx.) kg
G	A	A1	B5	d4	dynamic Cr newtons	static Cor newtons		
10	36.5	24.5	29.0	38.0	14000	7880	6250	0.7
12	41.5	27.5	31.0	45.0	19500	11300	5300	1.3
12	44.5	30.5	35.0	52.0	25700	15300	4500	1.7
12	51.0	34.5	36.0	58.0	32500	19900	4000	2.1
12	54.0	35.0	39.0	65.0	32500	20500	3700	2.8
16	55.0	36.0	42.0	70.0	35000	23200	3400	3.2
16	60.0	39.5	45.0	75.0	43500	29200	3100	4.0

Self-Lube cast iron pillow block units

SL Series

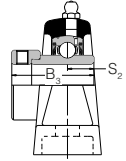
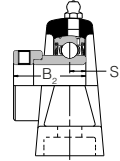
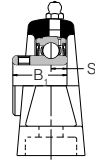
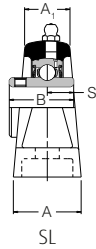
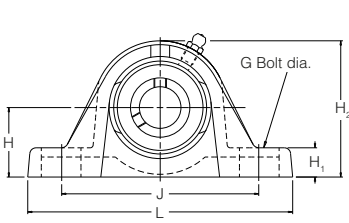

SL-A

SL-EC

SL-DEC

Shaft diameter		RHP designation				Basic bearing insert	Casting group	Dimensions (mm)				Bolt centres	
mm	inches							L	H	H1	H2	J _{max}	J _{min}
12		SL12		SL12EC		1017	1	119.0	26.97	11.0	54.0	91.5	85.5
15		SL15		SL15EC									
16		SL16		SL16EC									
17		SL17		SL17EC									
	1/2	SL1 1/2		SL1 1/2EC									
	5/8	SL1 5/8		SL1 5/8EC									
20		SL20	SL20A	SL20EC	SL20DEC	1020	2	126.5	31.75	12.5	63.7	100.5	88.5
	3/4	SL3/4	SL3/4A	SL3/4EC	SL3/4DEC								
25		SL25	SL25A	SL25EC	SL25DEC	1025	3	139.0	33.32	12.8	67.8	110.2	98.2
	7/8	SL7/8		SL7/8EC	SL7/8DEC								
	15/16	SL1 5/16		SL1 5/16EC	SL1 5/16DEC								
30		SL1	SL1A	SL1EC	SL1DEC								
	1 1/8	SL1 1/8		SL1 1/8EC	SL1 1/8DEC	1030	4	161.5	39.67	14.5	79.5	130.0	109.0
	1 3/16	SL1 3/16		SL1 3/16EC	SL1 3/16DEC								
	1 1/4	SL1 1/4R	SL1 1/4AR	SL1 1/4ECR	SL1 1/4DECR								
35		SL35	SL35A	SL35EC	SL35DEC	1035	5	166.0	46.02	16.0	91.5	136.5	121.5
	1 1/4	SL1 1/4	SL1 1/4A	SL1 1/4EC	SL1 1/4DEC								
	1 3/8	SL1 3/8		SL1 3/8EC	SL1 3/8DEC								
	1 7/16	SL1 7/16		SL1 7/16EC	SL1 7/16DEC								
40		SL40	SL40A	SL40EC	SL40DEC	1040	6	180.5	49.20	18.5	98.5	148.0	127.0
	1 1/2	SL1 1/2	SL1 1/2A	SL1 1/2EC	SL1 1/2DEC								
45		SL45	SL45A	SL45EC	SL45DEC	1045	7	197.5	52.37	18.4	106.4	161.5	141.5
	1 5/8	SL1 5/8		SL1 5/8EC	SL1 5/8DEC								
	1 11/16	SL1 11/16		SL1 11/16EC	SL1 11/16DEC								
	1 3/4	SL1 3/4	SL1 3/4A	SL1 3/4EC	SL1 3/4DEC								
50		SL50	SL50A	SL50EC	SL50DEC	1050	8	214.0	55.55	19.3	114.0	177.0	151.0
	1 7/8	SL1 7/8		SL1 7/8EC	SL1 7/8DEC								
	1 15/16	SL1 15/16		SL1 15/16EC	SL1 15/16DEC								
	2	SL2R			SL2DECR								
55		SL55		SL55DEC		1055	9	219.5	61.90	23.2	128.0	178.5	162.5
	2	SL2		SL2DEC									
	2 1/8	SL2 1/8		SL2 1/8EC	SL2 1/8DEC								
	2 3/16	SL2 3/16		SL2 3/16EC	SL2 3/16DEC								
60		SL60		SL60DEC		1060	10	240.0	68.25	24.6	140.6	201.0	176.0
	2 1/4	SL2 1/4		SL2 1/4EC	SL2 1/4DEC								
	2 3/8	SL2 3/8		SL2 3/8EC	SL2 3/8DEC								
	2 7/16	SL2 7/16		SL2 7/16EC	SL2 7/16DEC								
65		SL65R				1065	10/65	250.0	68.25	24.6	142.6	205.0	176.0
	2 1/2	SL2 1/2		SL2 1/2EC	SL2 1/2DEC								
65		SL65		SL65DEC		1075	11	286.0	82.55	28.0	165.5	241.5	200.5
70		SL70		SL70DEC									
75		SL75		SL75DEC									
	2 11/16	SL2 11/16		SL2 11/16EC	SL2 11/16DEC								
	2 3/4	SL2 3/4		SL2 3/4EC	SL2 3/4DEC								
	2 7/8	SL2 7/8		SL2 7/8EC	SL2 7/8DEC								
	2 15/16	SL2 15/16		SL2 15/16EC	SL2 15/16DEC								

Please check availability

Bearing inserts with flinger seals shown on pages 89 and 90 can be fitted into these housings. The unit reference has the suffix 'FS', e.g. SL35FS.

Triple seal bearing inserts shown on pages 86 to 88 can be fitted into these housings. The unit reference has a prefix 'T', e.g. TSL35.

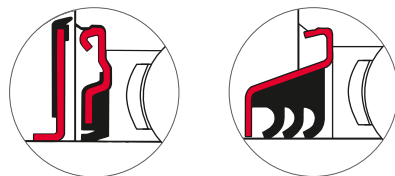

Dimensions (mm)										ISO Load ratings		Rec. max. speed rev/min	Mass (approx.) kg
G	A	A1	B	B1	B2	B3	s	s1	s2	dynamic Cr newtons	static Cor newtons		
10	30.5	20.5	27.38	-	28.63	-	11.58	6.53	-	9550	4800	7000	0.5
10	32.0	22.5	31.00	25.80	31.03	43.73	12.73	7.53	17.13	12800	6650	6700	0.6
10	36.0	24.5	34.10	27.30	31.03	44.43	14.33	7.53	17.53	14000	7880	6250	0.7
12	41.0	27.5	38.10	31.20	35.73	48.43	15.93	9.03	18.33	19500	11300	5300	1.3
12	44.5	30.5	42.90	34.90	38.93	51.13	17.53	9.53	18.83	25700	15300	4500	1.7
12	51.0	34.5	49.20	41.20	43.73	56.33	19.03	11.03	21.43	32500	19900	4000	2.1
12	54.0	35.0	49.20	41.20	43.73	56.33	19.04	11.04	21.43	32500	20500	3700	3.0
12	55.0	36.0	51.60	43.50	43.73	62.73	19.04	11.04	24.64	35000	23200	3400	3.4
16	60.0	39.5	55.60	-	-	71.42	22.24	-	27.84	43500	29200	3100	4.0
16	70.0	46.0	65.10	-	-	77.84	25.44	-	31.04	48000	33000	2800	6.1
16	70.0	45.0	65.10	-	-	85.74	25.44	-	34.14	57500	40000	2600	6.2
20	74.0	47.5	77.80	-	-	92.14	33.34	-	37.34	66000	49500	2300	11.6

Self-Lube cast iron pillow block units

MP Series

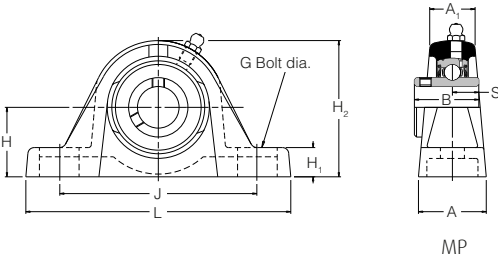

MP

Shaft diameter		RHP designation	Basic bearing insert	Casting group	Dimensions (mm)				Bolt centres	
mm	inches				L	H	H1	H2	J _{max}	J _{min}
25		MP25	1030	1	160.5	44.45	19.3	84.3	127.5	108.5
	1	MP1								
30		MP30	1035	2	166.0	47.60	17.5	93.0	136.5	121.5
	1 ³ / ₁₆	MP1 ³ / ₁₆								
	1 ¹ / ₄	MP1 ¹ / ₄								
35		MP35	1040	3	203.2	53.98	23.0	107.5	160.0	135.0
	1 ³ / ₈	MP1 ³ / ₈								
	1 ⁷ / ₁₆	MP1 ⁷ / ₁₆								
40		MP40	1045	4	222.2	58.72	22.5	116.7	172.5	145.0
	1 ¹ / ₂	MP1 ¹ / ₂								
45		MP45	1050	5	222.2	58.72	22.5	116.7	172.5	145.0
	1 ¹¹ / ₁₆	MP1 ¹¹ / ₁₆								
	1 ³ / ₄	MP1 ³ / ₄								
50		MP50	1055	6	219.5	63.50	24.8	129.5	178.5	162.5
	1 ⁷ / ₈	MP1 ⁷ / ₈								
	1 ¹⁵ / ₁₆	MP1 ¹⁵ / ₁₆								
	2	MP2								
55		MP55	1060	7	249.5	69.85	26.2	142.2	201.0	179.0
	2 ³ / ₁₆	MP2 ³ / ₁₆								
	2 ¹ / ₄	MP2 ¹ / ₄								
60		MP60	1070	8	266.0	76.20	27.0	153.0	224.5	189.5
65		MP65R								
	2 ⁷ / ₁₆	MP2 ⁷ / ₁₆								
	2 ¹ / ₂	MP2 ¹ / ₂								
65		MP65	1075	9	330.2	88.90	28.6	177.8	255.6	206.0
70		MP70								
	2 ¹¹ / ₁₆	MP2 ¹¹ / ₁₆								
	2 ³ / ₄	MP2 ³ / ₄								
75		MP75	1080	10	330.2	88.90	31.8	184.2	255.6	228.0
		2 ¹⁵ / ₁₆								
	3	MP3								
80		MP80	1085	11	381.0	101.60	31.8	203.2	317.5	260.0
		3 ³ / ₁₆								
	3 ¹ / ₄	MP3 ¹ / ₄								
85		MP85	1090	12	381.0	101.60	33.3	209.6	319.1	246.1
90		MP90								
	3 ⁷ / ₁₆	MP3 ⁷ / ₁₆								
	3 ¹ / ₂	MP3 ¹ / ₂								
95		MP95	3095	13	431.8	127.00	33.3	254.0	371.5	301.6
100		MP100								
	3 ¹⁵ / ₁₆	MP3 ¹⁵ / ₁₆								
	4	MP4								

Please check availability

Bearing inserts with flinger seals shown on pages 89 and 90 can be fitted into these housings. The unit reference has the suffix 'FS', e.g. MP40FS.

Triple seal bearing inserts shown on pages 86 to 88 can be fitted into these housings. The unit reference has a prefix 'T', e.g. TMP40.

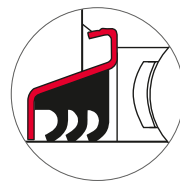
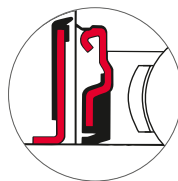

Dimensions (mm)					ISO Load ratings		Rec. max. speed	Mass (approx.)
G	A	A1	B	s	dynamic Cr newtons	static Cor newtons	rev/min	kg
12	41.5	27.5	38.10	15.93	19500	11300	5300	1.3
12	44.5	30.5	42.90	17.53	25700	15300	4500	1.7
12	57.0	40.5	49.20	19.03	32500	19900	4000	2.7
16	60.0	39.5	49.20	19.04	32500	20500	3700	3.2
16	60.0	39.5	51.60	19.04	35000	23200	3400	3.2
16	60.0	39.5	55.60	22.24	43500	29200	3100	4.0
20	69.5	46.00	65.10	25.44	48000	33000	2800	7.1
20	72.0	47.0	74.60	30.24	61000	45000	2450	9.3
24	88.9	66.7	77.80	33.34	66000	49500	2300	13.4
24	88.9	66.7	82.60	33.34	71500	54500	2150	14.3
24	101.6	68.3	85.70	34.15	83000	64000	2000	18.2
24	111.1	79.4	96.00	39.74	96000	71500	1900	23.4
24	120.6	98.4	117.48	49.31	157000	122000	1600	34.4

Self-Lube cast iron pillow block units with adapter sleeves

MP1000-K Series

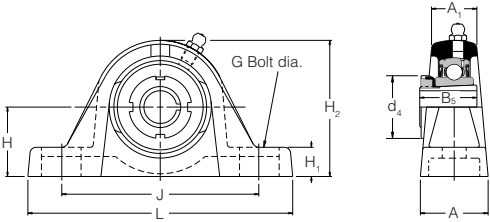

MP 1000-K

Shaft diameter		RHP designation complete unit	Sleeve nut & lockwasher only	Unit without sleeve, nut & lockwasher	Basic bearing insert	Casting group	Dimensions (mm)				Bolt centres	
mm	inches						L	H	H1	H2	J _{max}	J _{min}
25		MP1030-25K	H306	MP1030K	1030	1	160.5	44.45	19.3	87.4	127.5	108.5
	15/16	MP1030-15/16K	HE306-15/16									
	1	MP1030-1K	HE306-1									
30		MP1035-30K	H307	MP1035K	1035	2	166.0	47.60	17.5	93.0	136.5	121.5
	1 1/8	MP1035-1 1/8K	HE307-1 1/8									
	1 3/16	MP1035-1 3/16K	HE307-1 3/16									
35		MP1040-35K	H308	MP1040K	1040	3	203.2	53.98	23.0	106.4	160.0	135.0
	1 1/4	MP1040-1 1/4K	HE308-1 1/4									
	1 3/8	MP1040- 1 3/8K	HE308-1 3/8									
40		MP1045-40K	H309	MP1045K	1045	4	222.2	58.72	22.5	116.7	172.5	145.0
	1 7/16	MP1045-1 7/16K	HE309-1 7/16									
	1 1/2	MP1045-1 1/2K	HE309-1 1/2									
45		MP1050-45K	H310	MP1050K	1050	5	222.2	58.72	22.5	116.7	172.5	145.0
	1 11/16	MP1050-1 11/16K	HE310-1 11/16									
	1 3/4	MP1050-1 3/4K	HE310-2									
50		MP1055-50K	H311	MP1055K	1055	6	219.5	63.50	24.8	129.5	178.5	162.5
	1 15/16	MP1055-1 15/16K	HE311-1 15/16									
	2	MP1055-2K	HE311-2									

Please check availability

Dimensions (mm)					ISO Load ratings		Rec. max. speed rev/min	Mass (approx.) kg
G	A	A1	B5	d4	dynamic Cr newtons	static Cor newtons		
12	41.5	27.5	31.00	45.00	19500	11300	5300	1.3
12	44.5	30.5	35.00	52.00	25700	15300	4500	1.7
12	57.0	40.5	36.00	58.00	32500	19900	4000	2.7
16	60.0	39.5	39.00	65.00	32500	20500	3700	3.2
16	60.0	39.5	42.00	70.00	35000	23200	3400	3.2
16	60.0	39.5	45.00	75.00	43500	29200	3100	4.0

Self-Lube short base cast iron pillow block units

SNP Series (metric thread), CNP Series (UNC thread)**

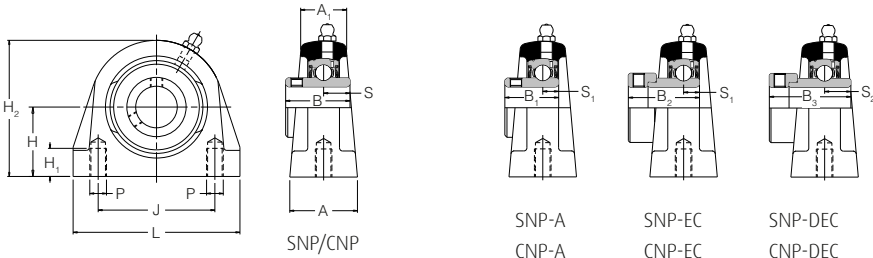

Shaft diameter		RHP designation				Basic bearing insert	Casting group	Dimensions (mm)				Bolt centres	
mm	inches							L	H	H1	H2	J	SNP
20		SNP20	SNP20A	SNP20EC	SNP20DEC	1020	2	65.0	33.30	13.5	65.8	50.8	M8x1.25
		SNP3/4	SNP3/4A	SNP3/4EC	SNP3/4DEC								
25		SNP25	SNP25A	SNP25EC	SNP25DEC	1025	3	70.0	36.50	13.5	71.5	50.8	M10x1.50
		SNP7/8		SNP7/8EC	SNP7/8DEC								
		SNP15/16		SNP15/16EC	SNP15/16DEC								
30	1	SNP1	SNP1A	SNP1EC	SNP1DEC	1030	4	96.0	42.90	16.5	83.9	76.2	M10x1.50
		SNP30	SNP30A	SNP30EC	SNP30DEC								
		SNP17/8		SNP17/8EC	SNP17/8DEC								
		SNP13/16		SNP13/16EC	SNP13/16DEC								
35	1 1/4	SNP1 1/4R	SNP1 1/4AR	SNP1 1/4ECR	SNP1 1/4DEC	1035	5	110.0	47.60	19.5	95.6	82.6	M10x1.50
		SNP35	SNP35A	SNP35EC	SNP35DEC								
		SNP1 1/4	SNP1 1/4A	SNP1 1/4EC	SNP1 1/4DEC								
		SNP1 3/8		SNP1 3/8EC	SNP1 3/8DEC								
40	1 7/8	SNP1 7/8		SNP1 7/8EC	SNP1 7/8DEC	1040	6	118.0	49.20	19.5	101.7	88.9	M12x1.75
		SNP40	SNP40A	SNP40EC	SNP40DEC								
		SNP1 1/2	SNP1 1/2A	SNP1 1/2EC	SNP1 1/2DEC								
45	1 7/8	SNP45	SNP45A	SNP45EC	SNP45DEC	1045	7	127.0	54.00	19.5	110.0	95.3	M12x1.75
		SNP1 5/8		SNP1 5/8EC	SNP1 5/8DEC								
		SNP1 11/16		SNP1 11/16EC	SNP1 11/16DEC								
		SNP1 3/4	SNP1 3/4A	SNP1 3/4EC	SNP1 3/4DEC								
50	1 7/8	SNP50	SNP50A	SNP50EC	SNP50DEC	1050	8	135.0	57.20	23.5	115.0	101.6	M16x2.00
		SNP1 7/8		SNP1 7/8EC	SNP1 7/8DEC								
		SNP1 15/16		SNP1 15/16EC	SNP1 15/16DEC								
55	2	SNP2R				1055	9	150.0	63.50	26.5	130.0	118.0	M16x2.00
		SNP55		SNP55DEC									
		SNP2		SNP2DEC									
		SNP2 1/8		SNP2 1/8DEC									
		SNP2 3/16		SNP2 3/16DEC									
60	2 1/4	SNP60		SNP60DEC		1060	10	154.0	69.90	26.5	141.5	118.0	M16x2.00
		SNP2 1/4		SNP2 1/4DEC									
		SNP2 3/8		SNP2 3/8DEC									
		SNP2 7/16		SNP2 7/16DEC									

Please check availability

**These units are identical to SNP series except for thread details

Bearing inserts with flinger seals shown on pages 89 and 90 can be fitted into these housings. The unit reference has the suffix 'FS', e.g. SNP25FS.

Triple seal bearing inserts shown on pages 86 to 88 can be fitted into these housings. The unit reference has a prefix 'T', e.g. TSNP25.

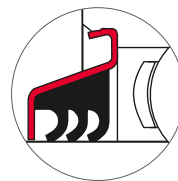
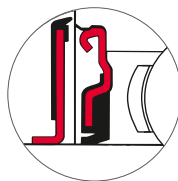

P	Dimensions (mm)										ISO Load ratings		Rec. max. speed rev/min	Mass (approx.) kg
	CNP	A	A1	B	B1	B2	B3	s	s1	s2	dynamic Cr newtons	static Cor newtons		
	3/8-16UNC	32.0	21.5	31.00	25.80	31.03	43.73	12.73	7.53	17.13	12800	6650	6700	0.9
	3/8-16UNC	36.0	25.0	34.10	27.30	31.03	44.43	14.33	7.53	17.53	14000	7880	6250	1.2
	7/16-14UNC	40.0	26.5	38.10	31.20	35.73	48.43	15.93	9.03	18.33	19500	11300	5300	1.8
	1/2-13UNC	45.0	30.0	42.90	34.90	38.93	51.13	17.53	9.53	18.83	25700	15300	4500	2.4
	1/2-13UNC	47.0	32.0	49.20	41.20	43.73	56.33	19.03	11.03	21.43	32500	19900	4000	2.8
	1/2-13UNC	48.0	33.0	49.20	41.20	43.73	56.33	19.04	11.04	21.43	32500	20500	3700	3.5
	5/8-11UNC	54.0	35.5	51.60	43.50	43.73	62.73	19.04	11.04	24.64	35000	23200	3400	3.3
	5/8-11UNC	60.0	41.5	55.60	-	-	71.42	22.24	-	27.84	43500	29200	3100	4.0
	5/8-11UNC	60.0	41.5	65.10	-	-	77.84	25.44	-	31.04	48000	33000	2800	4.6

Self-Lube cast iron flange bearing units

SF Series

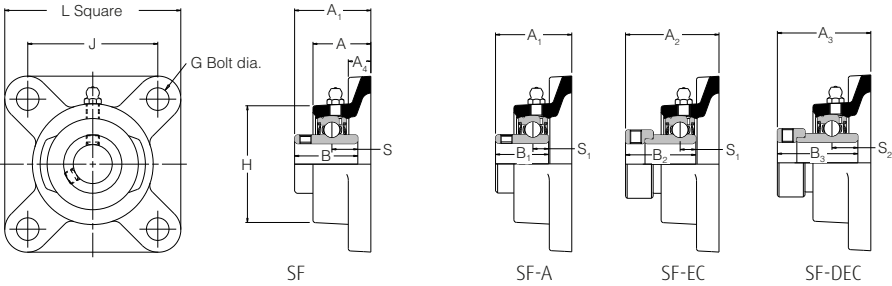

Shaft diameter		RHP designation				Basic bearing insert	Casting group	Dimensions (mm)					
mm	inches							L	H	J	G	A	A1
12		SF12		SF12EC		1017	1	76.2	52.5	54.00	10	24.6	32.87
15		SF15		SF15EC									
16		SF16		SF16EC									
17		SF17		SF17EC									
1/2		SF1/2		SF1/2EC									
3/8		SF3/8		SF3/8EC									
20		SF20	SF20A	SF20EC	SF20DEC	1020	2	85.7	60.3	63.50	10	27.8	37.26
3/4		SF3/4	SF3/4A	SF3/4EC	SF3/4DEC								
25		SF25	SF25A	SF25EC	SF25DEC	1025	3	95.3	68.0	70.00	10	28.6	38.84
7/8		SF7/8		SF7/8EC	SF7/8DEC								
15/16		SF15/16		SF15/16EC	SF15/16DEC								
1		SF1	SF1A	SF30EC	SF1DEC								
30		SF30	SF30A	SF1EC	SF30DEC	1030	4	108.0	82.6	82.50	10	29.8	42.21
1 1/8		SF1 1/8		SF1 1/8EC	SF1 1/8DEC								
1 3/16		SF1 3/16		SF1 3/16EC	SF1 3/16DEC								
1 1/4		SF1 1/4R	SF1 1/4AR	SF1 1/4ECR	SF1 1/4DEC								
35		SF35	SF35A	SF35EC	SF35DEC	1035	5	117.5	95.3	92.00	12	31.4	46.41
1 1/4		SF1 1/4	SF1 1/4A	SF1 1/4EC	SF1 1/4DEC								
1 3/8		SF1 3/8		SF1 3/8EC	SF1 3/8DEC								
1 7/16		SF1 7/16		SF1 7/16EC	SF1 7/16DEC								
40		SF40	SF40A	SF40EC	SF40DEC	1040	6	130.2	101.6	101.50	12	34.9	54.18
1 1/2		SF1 1/2	SF1 1/2A	SF1 1/2EC	SF1 1/2DEC								
45		SF45	SF45A	SF45EC	SF45DEC	1045	7	136.5	111.1	105.00	16	35.3	54.18
1 5/8		SF1 5/8		SF1 5/8EC	SF1 5/8DEC								
1 11/16		SF1 11/16		SF1 11/16EC	SF1 11/16DEC								
1 3/4		SF1 3/4	SF1 3/4A	SF1 3/4EC	SF1 3/4DEC								
50		SF50	SF50A	SF50EC	SF50DEC	1050	8	142.9	115.9	111.00	16	39.7	60.53
1 7/8		SF1 7/8		SF1 7/8EC	SF1 7/8DEC								
1 15/16		SF1 15/16		SF1 15/16EC	SF1 15/16DEC								
2		SF2R											
55		SF55			SF55DEC	1055	9	161.9	122.5	130.00	16	43.7	64.31
2		SF2			SF2DEC								
2 1/8		SF2 1/8			SF2 1/8DEC								
2 3/16		SF2 3/16			SF2 3/16DEC								
60		SF60			SF60DEC	1060	10	174.5	135.5	143.00	16	47.6	73.69
2 1/4		SF2 1/4			SF2 1/4DEC								
2 3/8		SF2 3/8			SF2 3/8DEC								
2 7/16		SF2 7/16			SF2 7/16DEC								
65		SF65R				1065	10/65	174.5	149.5	143.00	16	47.6	73.69
2 1/2		SF2 1/2			SF2 1/2DEC								
65		SF65			SF65DEC	1070	11	187.5	155.5	149.22	16	47.6	77.72
70		SF70			SF70DEC								
2 5/8		SF2 5/8			SF2 5/8DEC								
2 11/16		SF2 11/16			SF2 11/16DEC								
75		SF75			SF75DEC	1075	12	196.5	158.5	152.40	20	51.3	80.90
2 3/4		SF2 3/4			SF2 3/4DEC								
2 7/8		SF2 7/8			SF2 7/8DEC								
2 15/16		SF2 15/16			SF2 15/16DEC								
3		SF3											

Please check availability

Bearing inserts with flinger seals shown on pages 89 and 90 can be fitted into these housings. The unit reference has the suffix 'FS', e.g. SF25FS.

Triple seal bearing inserts shown on pages 86 to 88 can be fitted into these housings. The unit reference has a prefix 'T', e.g. TSF25.

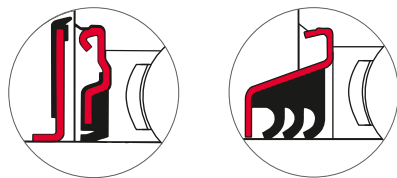

Dimensions (mm)										ISO Load ratings		Rec. max. speed	Mass (approx.)
A2	A3	A4	B	B1	B2	B3	s	s1	s2	dynamic Cr newtons	static Cor newtons	rev/min	kg
39.01	-	9.5	27.38	-	28.63	-	11.58	6.53	-	9550	4800	7000	0.5
42.42	45.54	11.1	31.00	25.80	31.03	43.73	12.73	7.53	17.13	12800	6650	6700	0.7
42.42	45.95	11.1	34.10	27.30	31.03	44.43	14.33	7.53	17.53	14000	7880	6250	1.0
46.66	50.90	12.7	38.10	31.20	35.73	48.43	15.93	9.03	18.33	19500	11300	5300	1.3
50.34	53.31	12.7	42.90	34.90	38.93	51.13	17.53	9.53	18.83	25700	15300	4500	1.7
56.52	58.90	12.7	49.20	41.20	43.73	56.33	19.03	11.03	21.43	32500	19900	4000	2.2
56.62	58.90	14.3	49.20	41.20	43.73	56.33	19.03	11.03	21.43	32500	20500	3700	2.6
60.60	66.07	14.3	51.60	43.50	43.73	62.73	19.04	11.04	24.64	35000	23200	3400	2.8
-	74.57	17.5	55.60	-	-	71.42	22.24	-	27.84	43500	29200	3100	4.0
-	80.77	17.5	65.10	-	-	77.84	25.44	-	31.04	48000	33000	2800	4.7
-	80.77	18.0	65.10	-	-	85.74	25.44	-	34.14	57500	40000	2600	4.7
-	84.86	18.0	74.60	-	-	85.74	30.24	-	34.14	61000	45000	2450	6.8
-	91.21	23.0	77.80	-	-	92.14	33.34	-	37.34	66000	49500	2300	8.6

Self-Lube cast iron flange bearing units

MSF Series

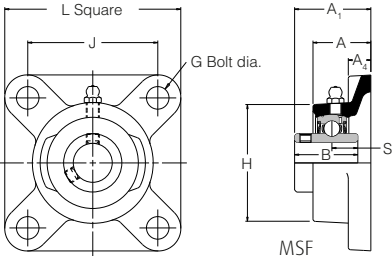

Shaft diameter		RHP designation	Basic bearing insert	Casting group	Dimensions (mm)		
mm	inches				L	H	J
25		MSF25	1030	1	108.0	82.6	82.50
	1	MSF1					
30		MSF30	1035	2	117.5	95.3	92.00
	1 ³ / ₁₆	MSF1 ³ / ₁₆					
	1 ¹ / ₄	MSF1 ¹ / ₄					
35		MSF35	1040	3	130.2	101.6	101.50
	1 ³ / ₈	MSF1 ³ / ₈					
	1 ⁷ / ₁₆	MSF1 ⁷ / ₁₆					
40		MSF40	1045	4	136.5	111.1	105.00
	1 ¹ / ₂	MSF1 ¹ / ₂					
45		MSF45	1050	5	142.9	115.9	111.00
	1 ¹¹ / ₁₆	MSF1 ¹¹ / ₁₆					
	1 ³ / ₄	MSF1 ³ / ₄					
50		MSF50	1055	6	161.9	122.5	130.00
	1 ⁷ / ₈	MSF1 ⁷ / ₈					
	1 ¹⁵ / ₁₆	MSF1 ¹⁵ / ₁₆					
	2	MSF2					
55		MSF55	1060	7	174.5	135.5	143.00
	2 ³ / ₁₆	MSF2 ³ / ₁₆					
	2 ¹ / ₄	MSF2 ¹ / ₄					
60		MSF60	1070	8	187.6	155.5	149.22
	2 ⁷ / ₁₆	MSF2 ⁷ / ₁₆					
	2 ¹ / ₂	MSF2 ¹ / ₂					
65		MSF65	1075	9	196.5	158.5	152.40
70		MSF70					
	2 ¹¹ / ₁₆	MSF2 ¹¹ / ₁₆					
	2 ³ / ₄	MSF2 ³ / ₄					
75		MSF75	1080	10	196.5	173.5	152.40
	2 ¹⁵ / ₁₆	MSF2 ¹⁵ / ₁₆					
	3	MSF3					
80		MSF80	1085	11	213.5	184.0	171.45
	3 ³ / ₁₆	MSF3 ³ / ₁₆					
	3 ¹ / ₄	MSF3 ¹ / ₄					
85		MSF85	1090	12	213.5	196.5	171.45
90		MSF90					
	3 ⁷ / ₁₆	MSF3 ⁷ / ₁₆					
	3 ¹ / ₂	MSF3 ¹ / ₂					
95		MSF95	3095	13	267.5	235.5	211.12
100		MSF100					
	3 ¹⁵ / ₁₆	MSF3 ¹⁵ / ₁₆					
	4	MSF4					

Please check availability

Bearing inserts with flinger seals shown on pages 89 and 90 can be fitted into these housings. The unit reference has the suffix 'FS', e.g. MSF35FS.

Triple seal bearing inserts shown on pages 86 to 88 can be fitted into these housings. The unit reference has a prefix 'T', e.g. TMSF35.

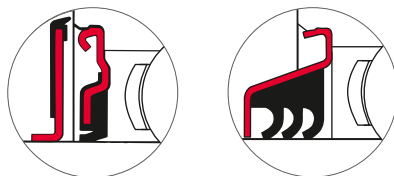

Dimensions (mm)						ISO Load ratings		Rec. max. speed rev/min	Mass (approx.) kg
G	A	A1	A4	B	s	dynamic Cr newtons	static Cor newtons		
10	29.8	42.21	12.7	38.10	15.93	19500	11300	5300	1.3
12	31.4	46.41	12.7	42.90	17.53	25700	15300	4500	1.7
12	34.9	54.18	12.7	49.20	19.03	32500	19900	4000	2.2
16	35.3	54.18	14.3	49.20	19.03	32500	20500	3700	2.6
16	39.7	60.53	14.3	51.60	19.04	35000	23200	3400	2.8
16	43.7	64.31	17.5	55.60	22.24	43500	29200	3100	4.0
16	47.6	73.69	17.5	65.10	25.44	48000	33000	2800	4.7
16	47.6	77.20	18.0	74.60	30.24	61000	45000	2450	6.8
20	51.3	80.90	23.0	77.80	33.34	66000	49500	2300	8.6
20	55.0	88.87	23.0	82.60	33.34	71500	54500	2150	9.3
20	54.3	89.64	26.0	85.70	34.15	83000	64000	2000	11.1
20	61.7	100.76	26.0	96.00	39.74	96000	71500	1900	13.2
24	83.5	126.95	32.0	117.48	49.31	157000	122000	1600	24.7

Self-Lube cast iron flange bearing units with adapter sleeves

MSF 1000-K Series

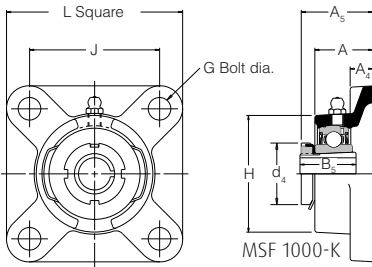

Shaft diameter mm inches	RHP designation complete unit	Sleeve nut & lockwasher only	Unit without sleeve, nut & lockwasher	Basic bearing insert	Casting group	Dimensions (mm)		
						L	H	J
20	MSF1025-20K	H305	MSF1025K	1025	SF3	95.3	68.0	70.0
3/4	MSF1025-3/4K	HE3053/4						
25	MSF1030-25K	H306	MSF1030K	1030	1	108.0	82.6	82.5
15/16	MSF1030-15/16K	HE306-15/16						
1	MSF1030-1K	HE306-1						
30	MSF1035-30K	H307	MSF1035K	1035	2	117.5	95.3	92.0
1 1/8	MSF1035-1 1/8K	HE307-1 1/8						
1 3/16	MSF1035-1 3/16K	HE307-1 3/16						
35	MSF1040-35K	H308	MSF1040K	1040	3	130.2	101.6	101.5
1 1/4	MSF1040-1 1/4K	HE308-1 1/4						
1 3/8	MSF1040-1 3/8K	HE308-1 3/8						
40	MSF1045-40K	H309	MSF1045K	1045	4	136.5	111.1	105.0
1 7/16	MSF1045-1 7/16K	HE309-1 7/16						
1 1/2	MSF1045-1 1/2K	HE309-1 1/2						
45	MSF1050-45K	H310	MSF1050K	1050	5	142.9	115.9	111.0
1 11/16	MSF1050-1 11/16K	HE310-1 11/16						
1 3/4	MSF1050-1 3/4K	HE310-1 3/4						
50	MSF1055-50K	H311	MSF1055K	1055	6	161.9	127.0	130.0
1 15/16	MSF1055-1 15/16K	HE311-1 15/16						
2	MSF1055-2K	HE311-2						

Please check availability

G	Dimensions (mm)					ISO Load ratings		Rec. max. speed rev/min	Mass (approx.) kg
	A	A4	A5	B5	d4	dynamic Cr newtons	static Cor newtons		
10	28.6	11.1	36.5	29.0	38.0	14000	7880	6250	1.0
10	29.8	12.7	38.0	31.0	45.0	19500	11300	5300	1.3
12	31.4	12.7	40.5	35.0	52.0	25700	15300	4500	1.7
12	34.9	12.7	45.0	36.0	58.0	32500	19900	4000	2.2
16	35.3	14.3	46.5	39.0	65.0	32500	20500	3700	2.6
16	39.7	14.3	52.0	42.0	70.0	35000	23200	3400	2.8
16	43.7	17.5	55.5	45.0	75.0	43500	29200	3100	4.0

Self-Lube cast iron flange bearing units

SFT Series

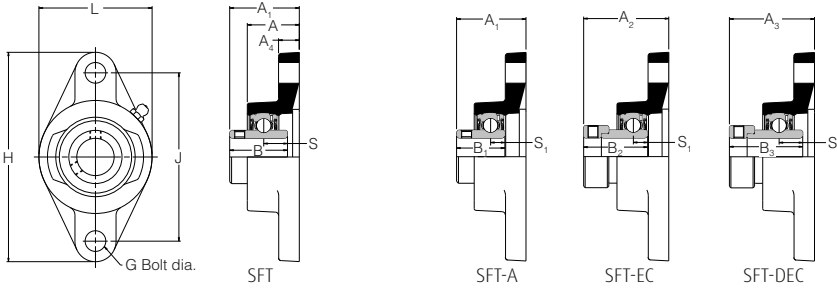

Shaft diameter		RHP designation				Basic bearing insert	Casting group	Dimensions (mm)					
mm	inches							L	H	J	G	A	A1
12		SFT12		SFT12EC		1017	1	52.5	98.5	76.50	10	24.6	32.87
15		SFT15		SFT15EC									
16		SFT16		SFT16EC									
17		SFT17		SFT17A									
	1/2	SFT1/2		SFT1/2EC									
	3/8	SFT3/8		SFT3/8EC									
20		SFT20	SFT20A	SFT20EC	SFT20DEC	1020	2	60.3	111.9	90.00	10	27.8	37.26
	3/4	SFT3/4	SFT3/4A	SFT3/4EC	SFT3/4DEC								
25		SFT25	SFT25A	SFT25EC	SFT25DEC	1025	3	70.0	125.5	99.00	10	28.6	38.84
	7/8	SFT7/8		SFT7/8EC	SFT7/8DEC								
	15/16	SFT15/16		SFT15/16EC	SFT15/16DEC								
	1	SFT1	SFT1A	SFT1EC	SFT1DEC								
30		SFT30	SFT30A	SFT30EC	SFT30DEC	1030	4	82.6	141.3	116.50	10	29.8	42.21
	1 1/8	SFT1 1/8		SFT1 1/8EC	SFT1 1/8DEC								
	1 3/16	SFT1 3/16		SFT1 3/16EC	SFT1 3/16DEC								
	1 1/4	SFT1 1/4R	SFT1 1/4AR	SFT1 1/4ECR	SFT1 1/4DEC								
35		SFT35	SFT35A	SFT35EC	SFT35DEC	1035	5	95.5	155.5	130.00	12	32.0	46.41
	1 1/4	SFT1 1/4	SFT1 1/4A	SFT1 1/4EC	SFT1 1/4DEC								
	1 3/8	SFT1 3/8		SFT1 3/8EC	SFT1 3/8DEC								
	1 7/16	SFT1 7/16		SFT1 7/16EC	SFT1 7/16DEC								
40		SFT40	SFT40A	SFT40EC	SFT40DEC	1040	6	101.6	171.4	143.50	12	34.9	54.18
	1 1/2	SFT1 1/2	SFT1 1/2A	SFT1 1/2EC	SFT1 1/2DEC								
45		SFT45	SFT45A	SFT45EC	SFT45DEC	1045	7	111.1	179.4	148.50	16	35.3	54.18
	1 5/8	SFT1 5/8		SFT1 5/8EC	SFT1 5/8DEC								
	1 11/16	SFT1 11/16		SFT1 11/16EC	SFT1 11/16DEC								
	1 3/4	SFT1 3/4	SFT1 3/4A	SFT1 3/4EC	SFT1 3/4DEC								
50		SFT50	SFT50A	SFT50EC	SFT50DEC	1050	8	115.9	188.9	157.00	16	39.7	60.53
	1 7/8	SFT1 7/8		SFT1 7/8EC	SFT1 7/8DEC								
	1 15/16	SFT1 15/16		SFT1 15/16EC	SFT1 15/16DEC								
	2	SFT2R											
55		SFT55			SFT55DEC	1055	9	127.0	215.9	184.00	16	43.7	64.31
	2	SFT2			SFT2DEC								
	2 1/8	SFT2 1/8			SFT2 1/8DEC								
	2 3/16	SFT2 3/16			SFT2 3/16DEC								
60		SFT60			SFT60DEC	1060	10	138.1	235.0	202.00	16	47.6	73.69
	2 1/4	SFT2 1/4			SFT2 1/4DEC								
	2 3/8	SFT2 3/8			SFT2 3/8DEC								
	2 7/16	SFT2 7/16			SFT2 7/16DEC								

Please check availability

Bearing inserts with flinger seals shown on pages 89 and 90 can be fitted into these housings. The unit reference has the suffix 'FS', e.g. SFT25FS.

Triple seal bearing inserts shown on pages 86 to 88 can be fitted into these housings. The unit reference has a prefix 'T', e.g. TSFT25.

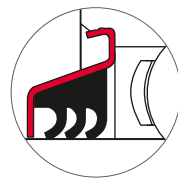
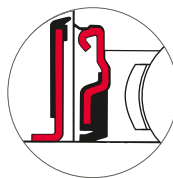

Dimensions (mm)										ISO Load ratings		Rec. max. speed	Mass (approx.)
A2	A3	A4	B	B1	B2	B3	s	s1	s2	dynamic Cr newtons	static Cor newtons	rev/min	kg
39.01	-	9.5	27.38	-	28.63	-	11.58	6.53	-	9550	4800	7000	0.4
42.42	45.54	11.1	31.00	25.80	31.03	43.73	12.73	7.53	17.13	12800	6650	6700	0.6
42.42	45.95	11.1	34.10	27.30	31.03	44.43	14.33	7.53	17.53	14000	7880	6520	0.9
46.66	50.09	12.7	38.10	31.20	35.73	48.43	15.93	9.03	18.33	19500	11300	5300	1.1
50.34	53.34	12.7	42.90	34.90	38.93	51.13	17.53	9.53	18.83	25700	15300	4500	1.4
56.62	58.90	12.7	49.20	41.20	43.73	56.33	19.03	11.03	21.43	32500	19900	4000	1.9
56.62	58.90	14.3	49.20	41.20	43.73	56.33	19.04	11.03	21.43	32500	20500	3700	2.2
60.60	66.07	14.3	51.60	43.50	43.73	62.73	19.04	11.04	24.64	35000	23200	3400	2.5
-	74.57	17.5	55.60	-	-	71.42	22.24	-	27.84	43500	29200	3100	3.5
-	80.77	17.5	65.10	-	-	77.84	25.44	-	31.04	48000	33000	2800	4.3

Self-Lube cast iron flange bearing units

MSFT Series

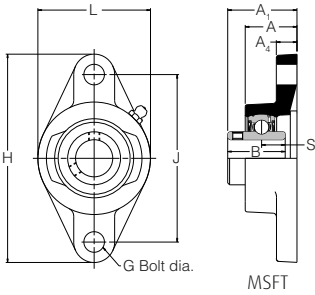

Shaft diameter		RHP designation	Basic bearing insert	Casting group	Dimensions (mm)		
mm	inches				L	H	J
25		MSFT25	1030	1	82.6	141.3	116.50
	1	MSFT1					
30		MSFT30	1035	2	95.5	155.5	130.00
	1 ³ / ₁₆	MSFT1 ³ / ₁₆					
	1 ¹ / ₄	MSFT1 ¹ / ₄					
35		MSFT35	1040	3	101.6	171.4	143.50
	1 ³ / ₈	MSFT1 ³ / ₈					
	1 ⁷ / ₁₆	MSFT1 ⁷ / ₁₆					
40		MSFT40	1045	4	111.1	179.4	148.50
	1 ¹ / ₂	MSFT1 ¹ / ₂					
45		MSFT45	1050	5	115.9	188.9	157.00
	1 ¹¹ / ₁₆	MSFT1 ¹¹ / ₁₆					
	1 ³ / ₄	MSFT1 ³ / ₄					
50		MSFT50	1055	6	127.0	215.9	184.00
	1 ⁷ / ₈	MSFT1 ⁷ / ₈					
	1 ¹⁵ / ₁₆	MSFT1 ¹⁵ / ₁₆					
	2	MSFT2					
55		MSFT55	1060	7	138.1	235.0	202.00
	2 ¹ / ₁₆	MSFT2 ¹ / ₁₆					

Please check availability

Bearing inserts with flinger seals shown on pages 89 and 90 can be fitted into these housings. The unit reference has the suffix 'FS', e.g. MSFT40FS.

Triple seal bearing inserts shown on pages 86 to 88 can be fitted into these housings. The unit reference has a prefix 'T', e.g. TMSFT40.

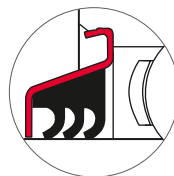
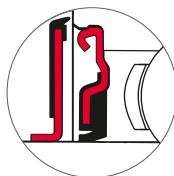

Dimensions (mm)						ISO Load ratings		Rec. max. speed rev/min	Mass (approx.) kg
G	A	A1	A4	B	s	dynamic Cr newtons	static Cor newtons		
10	29.8	42.21	12.7	38.10	15.93	19500	11300	5300	1.1
12	32.0	46.41	12.7	42.90	17.53	25700	15300	4500	1.4
12	34.9	54.18	12.7	49.20	19.03	32500	19900	4000	1.9
16	35.3	54.18	14.3	49.20	19.04	32500	20500	3700	2.2
16	39.7	60.53	14.3	51.60	19.04	35000	23200	3400	2.5
16	43.7	64.31	17.5	55.60	22.24	43500	29200	3100	3.5
16	47.6	73.69	17.5	65.10	25.44	48000	33000	2800	4.3

Self-Lube cast iron flange bearing units with adapter sleeves

MSFT 1000-K Series

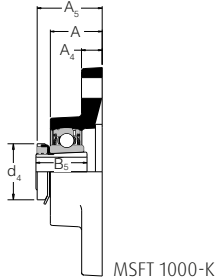
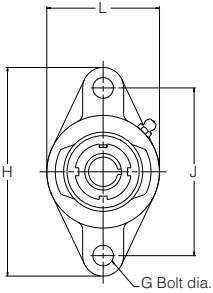

MSFT 1000-K

Shaft diameter mm inches	RHP designation complete unit	Sleeve nut & lockwasher only	Unit without sleeve, nut & lockwasher	Basic bearing insert	Casting group	Dimensions (mm)		
						L	H	J
20 3/4	MSFT1025-20K	H305	MSFT1025K	1025	SFT3	68.3	123.8	99.0
	MSFT1025-3/4K	HE305-3/4						
25 15/16 1	MSFT1030-25K	H306	MSFT1030K	1030	1	82.6	141.3	116.5
	MSFT1030-15/16K	HE306-15/16						
30 1 1/8 1 3/16	MSFT1030-1K	HE306-1				95.5	155.5	130.0
	MSFT1030-30K	H307	MSFT1035K	1035	2			
35 1 1/4 1 3/8	MSFT1035-1 1/8K	HE307-1 1/8				101.6	171.4	143.5
	MSFT1035-1 3/16K	HE307-1 3/16						
35 1 1/4 1 3/8	MSFT1040-35K	H308	MSFT1040K	1040	3	101.6	171.4	143.5
	MSFT1040-1 1/4K	HE308-1 1/4						
40 1 7/16 1 1/2	MSFT1040-1 3/8K	HE308-1 3/8				111.1	179.4	148.5
	MSFT1040-40K	H309	MSFT1045K	1045	4			
45 1 11/16 1 3/4	MSFT1045-40K	H309	MSFT1045K	1045	4	111.1	179.4	148.5
	MSFT1045-1 7/16K	HE309-1 7/16						
45 1 11/16 1 3/4	MSFT1045-1 1/2K	HE309-1 1/2				115.9	188.9	157.0
	MSFT1050-45K	H310	MSFT1050K	1050	5			
50 1 5/8 2	MSFT1050-1 11/16K	HE310-1 11/16				127.0	215.9	184.0
	MSFT1050-1 3/4K	HE310-1 3/4						
50 1 5/8 2	MSFT1055-50K	H311	MSFT1055K	1055	6	127.0	215.9	184.0
	MSFT1055-1 5/8K	HE311-1 5/8						
	MSFT1055-2K	HE311-2						

Please check availability

G	Dimensions (mm)					ISO Load ratings		Rec. max. speed rev/min	Mass (approx.) kg
	A	A4	A5	B5	d4	dynamic Cr newtons	static Cor newtons		
10	28.6	11.1	36.5	29.0	38.0	14000	7880	6250	0.9
10	29.8	12.7	38.0	31.0	45.0	19500	11300	5300	1.1
12	32.0	12.7	40.5	35.0	52.0	25700	15300	4500	1.4
12	34.9	12.7	45.0	36.0	58.0	32500	19900	4000	1.9
16	35.3	14.3	46.5	39.0	65.0	32500	20500	3700	2.2
16	39.7	14.3	52.0	42.0	70.0	35000	23200	3400	2.5
16	43.7	17.5	55.5	45.0	75.0	43500	29200	3100	3.5

Self-Lube cast iron flange bearing units

LFTC Series

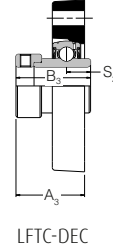
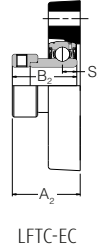
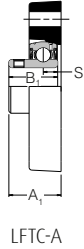
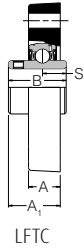
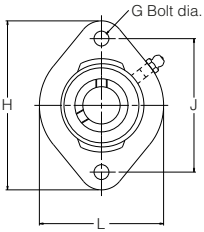

Shaft diameter		RHP designation				Basic bearing insert	Casting group	Dimensions (mm)				
mm	inches							L	H	J	G	A
12		LFTC12		LFTC12EC		1017	1	58.5	81.0	63.5	6.0	15.0
15		LFTC15		LFTC15EC								
16		LFTC16		LFTC16EC								
17		LFTC17		LFTC17EC								
1/2		LFTC1/2		LFTC1/2EC								
5/8		LFTC5/8		LFTC5/8EC								
20		LFTC20	LFTC20A	LFTC20EC	LFTC20DEC	1020	2	66.5	90.5	71.5	8.0	17.0
3/4		LFTC3/4	LFTC3/4A	LFTC3/4EC	LFTC3/4DEC							
25		LFTC25	LFTC25A	LFTC25EC	LFTC25DEC	1025	3	71.0	96.0	76.0	8.0	17.5
7/8		LFTC7/8		LFTC7/8EC	LFTC7/8DEC							
15/16		LFTC15/16		LFTC15/16EC	LFTC15/16DEC							
1		LFTC1	LFTC1A	LFTC1EC	LFTC1DEC							
30		LFTC30	LFTC30A	LFTC30EC	LFTC30DEC	1030	4	84.0	112.0	90.5	10.0	20.5
1 1/8		LFTC1 1/8		LFTC1 1/8EC	LFTC1 1/8DEC							
1 1/16		LFTC1 1/16		LFTC1 1/16EC	LFTC1 1/16DEC							
1 1/4		LFTC1 1/4	LFTC1 1/4A	LFTC1 1/4EC	LFTC1 1/4DEC							
35		LFTC35	LFTC 35A	LFTC35EC	LFTC35DEC	1035	5	93.0	125.0	100.0	10.0	22.0
1 1/4		LFTC1 1/4L	LFTC1 1/4AL	LFTC1 1/4ECL	LFTC1 1/4DECL							
1 3/8		LFTC1 3/8		LFTC1 3/8EC	LFTC1 3/8DEC							
1 7/16		LFTC1 7/16		LFTC1 7/16EC	LFTC1 7/16DEC							

Please check availability

Bearing inserts with flinger seals shown on pages 89 and 90 can be fitted into these housings. The unit reference has the suffix 'FS', e.g. LFTC 7/8 FS.

Triple seal bearing inserts shown on pages 86 to 88 can be fitted into these housings. The unit reference has a prefix 'T', e.g. TLFTC 7/8.

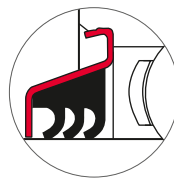
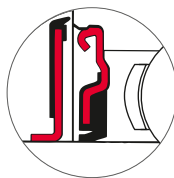

Dimensions (mm)										ISO Load ratings		Rec. max. speed rev/min	Mass (approx.) kg
A1	A2	A3	B	B1	B2	B3	s	s1	s2	dynamic Cr newtons	static Cor newtons		
24.27	30.43	-	27.38	-	28.63	-	11.58	6.53	-	9550	4800	7000	0.3
27.76	32.92	36.04	31.00	25.80	31.03	43.73	12.73	7.53	17.13	12800	6650	6700	0.4
29.24	32.82	36.35	34.00	27.30	31.03	44.43	14.33	7.53	17.53	14000	7880	6250	0.5
33.62	38.07	41.50	38.10	31.20	35.73	48.43	15.93	9.03	18.33	19500	11300	5300	0.8
37.80	41.74	44.71	42.90	34.90	38.93	51.13	17.53	9.53	18.83	25700	15300	4500	1.1

Self-Lube cast iron flange bearing units

FC Series

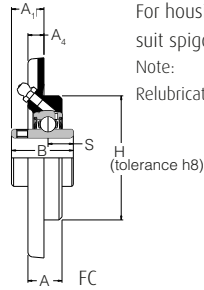
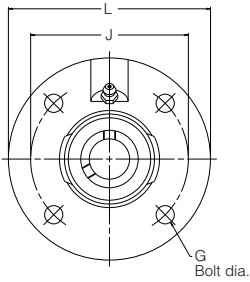

For housing tolerances to suit spigot 'H' see page 19

Note:

Relubrication hole - M5 x 0.8 pitch

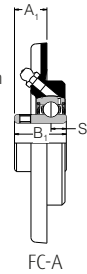

FC-A

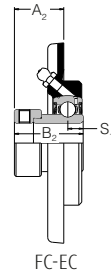

FC-EC

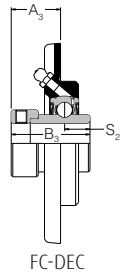

FC-DEC

Shaft diameter		RHP designation				Basic bearing insert	Casting group	Dimensions (mm)					
mm	inches							L	H	J	G	A	A1
20		FC20	FC20A	FC20EC	FC20DEC	1020	2	100.0	62.0	78.0	8	17.0	16.29
		FC3/4	FC3/4A	FC3/4EC	FC3/4DEC								
25		FC25	FC25A	FC25EC	FC25DEC	1025	3	115.0	70.0	90.0	8	19.0	17.34
		FC7/8		FC7/8EC	FC7/8DEC								
		FC15/16		FC15/16EC	FC15/16DEC								
30		FC1	FC1A	FC1EC	FC1DEC	1030	4	125.0	80.0	100.0	10	20.5	20.22
		FC30	FC30A	FC30EC	FC30DEC								
		FC13/16		FC13/16EC	FC13/16DEC								
		FC13/16	FC13/16AR	FC13/16AECR	FC13/16ADEC								
35		FC35	FC35A	FC35EC	FC35DEC	1035	5	135.0	90.0	110.0	10	20.5	24.40
		FC13/8	FC13/8A	FC13/8EC	FC13/8DEC								
		FC17/16		FC17/16EC	FC17/16DEC								
		FC17/16	FC17/16AR	FC17/16AECR	FC17/16ADEC								
40		FC40	FC40A	FC40EC	FC40DEC	1040	6	145.0	100.0	120.0	10	23.0	29.18
		FC11/2	FC11/2A	FC11/2EC	FC11/2DEC								
45		FC45	FC45A	FC45EC	FC45DEC	1045	7	155.0	105.0	130.0	12	25.0	28.18
		FC13/8		FC13/8EC	FC13/8DEC								
		FC111/16		FC111/16EC	FC111/16DEC								
		FC13/4	FC13/4A	FC13/4EC	FC13/4DEC								
50		FC50	FC50A	FC50EC	FC50DEC	1050	8	165.0	110.0	135.0	12	25.0	31.52
		FC17/8		FC17/8EC	FC17/8DEC								
		FC115/16		FC115/16EC	FC115/16DEC								
55		FC2R				1055	9	185.0	125.0	150.0	16	27.5	33.30
		FC55		FC55DEC									
		FC2		FC2DEC									
		FC23/8		FC23/8DEC									
60		FC23/16		FC23/16DEC		1060	10	195.0	135.0	160.0	16	29.0	38.65
		FC60		FC60DEC									
		FC23/4		FC23/4DEC									
		FC23/8		FC23/8DEC									
	FC27/16		FC27/16DEC										

Please check availability

Bearing inserts with flinger seals shown on pages 89 and 90 can be fitted into these housings. The unit reference has the suffix 'FS', e.g. FC40FS.

Triple seal bearing inserts shown on pages 86 to 88 can be fitted into these housings. The unit reference has a prefix 'T', e.g. TFC40.

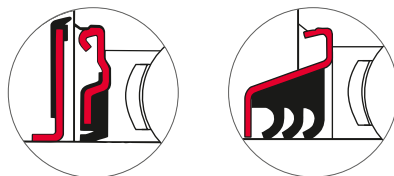

Dimensions (mm)											ISO Load ratings		Rec. max. speed rev/min	Mass (approx.) kg
A2	A3	A4	B	B1	B2	B3	s	s1	s2	dynamic Cr newtons	static Cor newtons			
21.45	24.57	8.00	31.00	25.80	31.03	43.73	12.73	7.53	17.13	12800	6650	6700	0.7	
20.86	24.41	9.00	34.10	27.30	31.03	44.43	14.33	7.53	17.53	14000	7880	6250	0.9	
24.64	28.10	9.50	38.10	31.20	35.73	48.43	15.93	9.03	18.33	19500	11300	5300	1.1	
28.33	31.29	10.00	42.90	34.90	38.93	51.13	17.53	9.53	18.83	25700	15300	4500	1.5	
31.59	33.88	11.50	49.20	41.20	43.73	56.33	19.03	11.03	21.43	32500	19900	4000	1.8	
30.59	32.88	12.00	49.20	41.20	43.73	56.33	19.04	11.03	21.43	32500	20500	3700	2.2	
31.63	37.14	13.00	51.60	43.50	43.73	62.73	19.04	11.04	24.64	35000	23200	3400	2.8	
-	43.72	15.00	55.60	-	-	71.42	22.24	-	27.84	43500	29200	3100	4.0	
-	45.89	16.00	65.10	-	-	77.84	25.44	-	31.04	48000	33000	2800	4.7	

Self-Lube cast iron flange cartridge bearing units

MFC Series

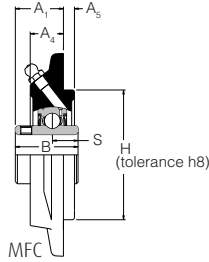
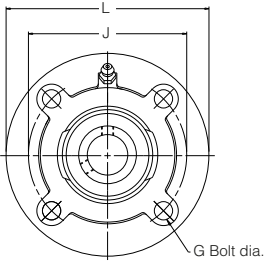

For housing tolerances to suit spigot 'H' see page 19

Shaft diameter		RHP designation	Basic bearing insert	Casting group	Dimensions (mm)		
mm	inches				L	H	J
25		MFC25	1030	1	111.1	76.2	92.1
	1	MFC1					
30	1¼	MFC1¼R	1035	2	127.0	85.7	104.8
	1⅜	MFC30					
	1½	MFC1½					
35		MFC35	1040	3	133.4	92.1	111.1
	1¾	MFC40					
	1⅞	MFC1⅞					
	2	MFC17/16					
40	1½	MFC1½	1050	4	155.6	108.0	130.2
	1⅞	MFC45					
	2	MFC11⅞					
45	1¾	MFC1¾	1055	5	161.9	114.3	136.5
	2	MFC2R					
	2¼	MFC50					
50	1⅞	MFC1⅞	1060	6	181.0	127.0	152.4
	2	MFC2					
	2¼	MFC55					
55	2¼	MFC2¾	1070	7	193.7	139.7	165.1
	2½	MFC60					
	2⅞	MFC65R					
60	2½	MFC2½	1075	8	222.2	161.9	190.5
	2⅞	MFC65					
	3	MFC70					
65	2⅞	MFC2⅞	1080	9	222.2	161.9	190.5
	3	MFC75					
	3¼	MFC80					
70	3	MFC23¼	1090	10	260.4	187.3	219.1
	3¼	MFC85					
	3½	MFC90					
75	3¼	MFC3¼	3095	11	298.4	228.6	260.4
	3½	MFC85					
	3⅞	MFC95					
80	3½	MFC3½	3095	11	298.4	228.6	260.4
	3⅞	MFC95					
	4	MFC100					
85	3⅞	MFC3⅞	3095	11	298.4	228.6	260.4
	4	MFC4					

Please check availability

Bearing inserts with flinger seals shown on pages 89 and 90 can be fitted into these housings. The unit reference has the suffix 'FS', e.g. MFC30FS.

Triple seal bearing inserts shown on pages 86 to 88 can be fitted into these housings. The unit reference has a prefix 'T', e.g. TMFC30.

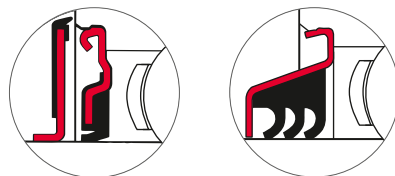

Dimensions (mm)						ISO Load ratings		Rec. max. speed	Mass (approx.)
G	A1	A4	A5	B	s	dynamic Cr newtons	static Cor newtons	rev/min	kg
8	33.32	21.0	6.4	38.10	15.93	19500	11300	5300	1.4
10	33.32	19.0	6.4	42.90	17.53	25700	15300	4500	1.5
10	38.10	19.0	6.4	49.20	19.03	32500	19900	4000	1.9
10	39.67	19.0	6.4	51.60	19.04	35000	23200	3400	2.7
10	39.67	19.0	6.4	55.60	22.24	43500	29200	3100	3.0
12	42.85	15.9	9.5	65.10	25.44	48000	33000	2800	3.4
12	46.02	15.9	12.7	74.60	30.24	61000	45000	2450	4.5
16	50.80	21.0	12.7	77.80	33.34	66000	49500	2300	5.9
16	50.80	16.7	12.7	82.60	33.34	71500	54500	2150	5.4
20	67.46	29.4	12.7	96.00	39.74	96000	71500	1900	9.8
20	88.90	46.0	12.7	117.48	49.31	157000	122000	1600	17.7

Self-Lube cast iron take-up bearing units

ST Series

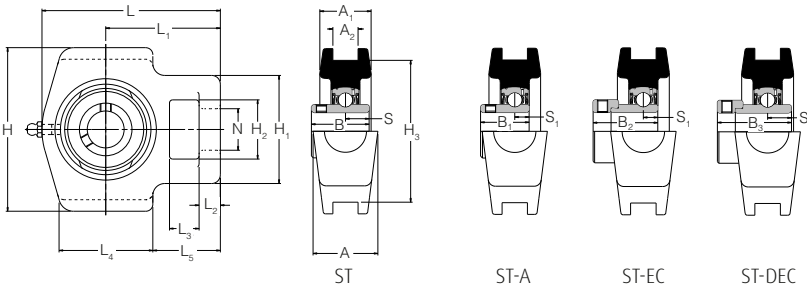

Shaft diameter		RHP designation				Basic bearing insert	Casting group	Dimensions (mm)						
mm	inches							L	L1	L2	L3	L4	L5	H
20		ST20	ST20A	ST20EC	ST20DEC	1020	2	95.5	62.0	11.5	16.0	50.5	36.5	88.5
	3/4	ST13/4	ST13/4A	ST13/4EC	ST13/4DEC									
25		ST25	ST25A	ST25EC	ST25DEC	1025	3	98.0	62.0	11.5	16.0	50.5	36.5	88.5
	7/8	ST7/8		ST7/8EC	ST7/8DEC									
	15/16	ST15/16		ST15/16EC	ST15/16DEC									
	1	ST1	ST1A	ST1EC	ST1DEC									
30		ST30	ST30A	ST30EC	ST30DEC	1030	4	115.5	72.5	12.5	16.5	64.5	43.0	101.5
	1 1/8	ST1 1/8		ST1 1/8EC	ST1 1/8DEC									
	1 3/16	ST1 3/16		ST1 3/16EC	ST1 3/16DEC									
	1 1/4	ST1 1/4R	ST1 1/4AR	ST1 1/4R EC	ST1 1/4R DEC									
35		ST35	ST35A	ST35EC	ST35DEC	1035	5	124.0	75.5	12.5	16.5	64.5	43.0	101.5
	1 1/4	ST1 1/4	ST1 1/4A	ST1 1/4EC	ST1 1/4DEC									
	1 3/8	ST1 3/8		ST1 3/8EC	ST1 3/8DEC									
	1 7/16	ST1 7/16		ST1 7/16EC	ST1 7/16DEC									
40		ST40	ST40A	ST40EC	ST40DEC	1040	6	143.5	89.2	15.5	20.5	81.5	50.5	118.0
	1 1/2	ST1 1/2	ST1 1/2A	ST1 1/2EC	ST1 1/2DEC									
45		ST45	ST45A	ST45EC	ST45DEC	1045	7	147.0	89.2	15.5	20.5	81.5	50.5	118.0
	1 5/8	ST1 5/8		ST1 5/8EC	ST1 5/8DEC									
	1 11/16	ST1 11/16		ST1 11/16EC	ST1 11/16DEC									
	1 3/4	ST1 3/4	ST1 3/4A	ST1 3/4EC	ST1 3/4DEC									
50		ST50	ST50	ST50EC	ST50DEC	1050	8	151.0	90.5	15.5	20.5	81.5	50.5	118.0
	1 7/8	ST1 7/8		ST1 7/8EC	ST1 7/8DEC									
	1 15/16	ST1 15/16		ST1 15/16EC	ST1 15/16DEC									
	2	ST2												
55		ST55		ST55DEC		1055	9	182.0	114.0	19.0	32.0	97.5	70.0	146.0
	2	ST2		ST2DEC										
	2 1/8	ST2 1/8		ST2 1/8DEC										
	2 3/16	ST2 3/16		ST2 3/16DEC										
60		ST60		ST60DEC		1060	10	192.0	119.0	19.0	32.0	97.5	70.0	146.0
	2 1/4	ST2 1/4		ST2 1/4DEC										
	2 3/8	ST2 3/8		ST2 3/8DEC										
	2 1/2	ST2 1/2		ST2 1/2DEC										
65		ST65		ST65DEC		1070	11	222.5	137.5	21.5	32.0	120.5	77.0	166.5
70		ST70		ST70DEC										
	2 1/2	ST2 1/2		ST2 1/2DEC										
	2 11/16	ST2 11/16		ST2 11/16DEC										
75		ST75		ST75DEC		1075	12	222.5	137.5	21.5	32.0	120.5	77.0	166.5
	2 3/4	ST2 3/4		ST2 3/4DEC										
	2 7/8	ST2 7/8		ST2 7/8DEC										
	2 15/16	ST2 15/16		ST2 15/16DEC										
80		ST80				1080	13	231.5	139.5	20.5	32.0	125.0	74.0	184.0
	3	ST3												
	3 3/16	ST3 3/16												
85		ST85				1085	14	260.5	162.0	28.5	38.0	140.0	90.5	198.5
	3 1/4	ST3 1/4												
	3 3/8	ST3 3/8												
	3 7/16	ST3 7/16												

Please check availability

Bearing inserts with flinger seals shown on pages 89 and 90 can be fitted into these housings. The unit reference has the suffix 'FS', e.g. ST45FS.

Triple seal bearing inserts shown on pages 86 to 88 can be fitted into these housings. The unit reference has a prefix 'T', e.g. TST45.

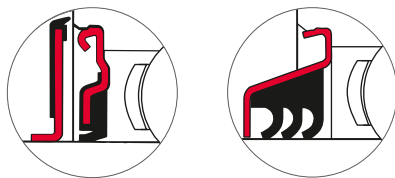

Dimensions (mm)														ISO Load ratings		Rec. max. speed	Mass (approx.)
H1	H2	H3	N	A	A1	A2	B	B1	B2	B3	s	s1	s2	dynamic Cr newtons	static Cor newtons	rev/min	kg
58.5	32.0	76.0	22.5	36.0	27.5	13.50	31.00	25.80	31.03	43.73	12.73	7.53	17.13	12800	6650	6700	0.8
58.5	32.0	76.0	22.5	36.0	27.5	13.50	34.10	27.30	31.03	44.43	14.33	7.53	17.53	14000	7880	6250	1.0
64.5	37.5	89.0	22.5	36.5	30.0	13.50	38.10	31.20	35.73	48.43	15.93	9.03	18.33	19500	11300	5300	1.6
64.5	37.5	89.0	22.5	36.5	30.0	13.50	42.90	34.90	38.93	51.13	17.53	9.53	18.83	25700	15300	4500	1.6
82.5	49.5	101.0	29.0	49.5	37.0	17.50	49.20	41.20	43.73	56.33	19.03	11.03	21.43	32500	19900	4000	2.7
82.5	49.5	101.0	29.0	49.5	37.0	17.50	49.20	41.20	43.73	56.33	19.04	11.03	21.43	32500	20500	3700	2.8
82.5	49.5	101.0	29.0	49.5	37.0	17.50	51.60	43.50	43.73	62.73	19.04	11.03	24.64	35000	23200	3400	2.8
101.0	64.0	130.0	35.0	63.5	46.5	27.00	55.60	-	-	71.42	22.24	-	27.84	43500	29200	3100	4.2
101.0	64.0	130.0	35.0	63.5	46.5	27.00	65.10	-	-	77.84	25.44	-	31.04	48000	33000	2800	5.4
113.0	70.0	150.8	42.0	70.0	50.5	27.00	74.60	-	-	85.74	30.24	-	34.14	61000	45000	2450	7.9
113.0	70.0	150.8	42.0	70.0	50.5	27.00	77.80	-	-	92.14	33.34	-	37.34	66000	49500	2300	8.4
113.0	70.0	165.1	42.0	70.0	54.0	27.00	82.60	-	-	-	33.34	-	-	71500	54500	2150	9.0
124.0	73.0	173.0	47.5	79.5	68.5	46.05	85.70	-	-	-	34.15	-	-	83000	64000	2000	13.7

Self-Lube cast iron take-up bearing units

MST Series

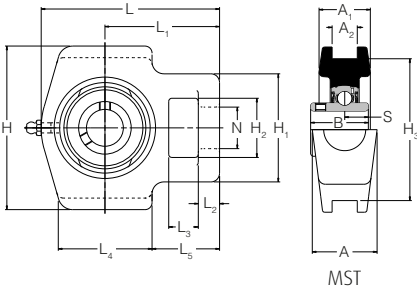

Shaft diameter		RHP designation	Basic bearing insert	Casting group	Dimensions (mm)					
mm	inches				L	L1	L2	L3	L4	L5
25		MST25	1030	1	115.5	72.5	12.5	16.5	64.5	43.0
	1	MST1								
30		MST30	1035	2	124.0	75.5	12.5	16.5	64.5	43.0
	1 ³ / ₁₆	MST1³/₁₆								
	1 ¹ / ₄	**								
35		MST35	1040	3	143.5	89.2	15.5	20.5	81.5	50.5
	1 ³ / ₈	MST1³/₈								
	1 ⁷ / ₁₆	MST1⁷/₁₆								
40		MST40	1045	4	147.0	89.2	15.5	20.5	81.5	50.5
	1 ¹ / ₂	MST1¹/₂								
45		MST45	1050	5	151.0	90.5	15.5	20.5	81.5	50.5
	1 ¹¹ / ₁₆	MST1¹¹/₁₆								
	1 ³ / ₄	MST1³/₄								
50		MST50	1055	6	182.0	114.0	19.0	32.0	97.5	70.0
	1 ⁷ / ₈	MST1⁷/₈								
	1 ¹⁵ / ₁₆	MST1¹⁵/₁₆								
	2	**								
55		MST55	1060	7	192.0	119.0	19.0	32.0	97.5	70.0
	2 ³ / ₁₆	MST2³/₁₆								
	2 ¹ / ₄	**								
60		MST60	1070	8	222.5	137.5	21.5	32.0	120.5	77.0
	2 ⁷ / ₁₆	MST2⁷/₁₆								
	2 ¹ / ₂	**								
65		MST65	1075	9	222.5	137.5	21.5	32.0	120.5	77.0
70		MST70								
	2 ¹¹ / ₁₆	MST2¹¹/₁₆								
	2 ³ / ₄	**								
75		MST75	1080	10	231.5	139.5	20.5	32.0	125.0	74.0
	2 ⁹ / ₁₆	MST2⁹/₁₆								
	3	**								
80		MST80	1085	11	260.5	162.0	28.5	38.0	140.0	90.5
	3 ¹ / ₁₆	MST3¹/₁₆								
	3 ¹ / ₄	**								
85		MST85	1090	12	270.0	165.0	28.5	38.0	152.5	90.0
90		MST90								
	3 ⁷ / ₁₆	MST3⁷/₁₆								
	3 ¹ / ₂	MST3¹/₂								
95		MST95	3095	13	317.5	190.5	32.0	38.0	175.0	103.0
100		MST100								
	3 ¹⁵ / ₁₆	MST3¹⁵/₁₆								
	4	MST4								

Please check availability

** For these bore sizes select from ST series (see page 54)

Bearing inserts with flinger seals shown on pages 89 and 90 can be fitted into these housings. The unit reference has the suffix 'FS', e.g. MST35FS.

Triple seal bearing inserts shown on pages 86 to 88 can be fitted into these housings. The unit reference has a prefix 'T', e.g. TMST35.

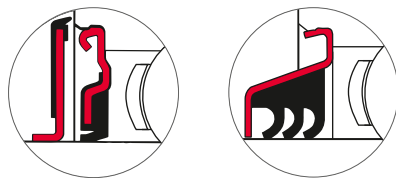

Dimensions (mm)										ISO Load ratings		Rec. max. speed rev/min	Mass (approx.) kg
H	H1	H2	H3	N	A	A1	A2	B	s	dynamic Cr newtons	static Cor newtons		
101.5	64.5	37.5	89.0	22.5	36.5	30.0	13.50	38.10	15.93	19500	11300	5300	1.6
101.5	64.5	37.5	89.0	22.5	36.5	30.0	13.50	42.90	17.53	25700	15300	4500	1.6
118.0	82.5	49.5	101.0	29.0	49.5	37.0	17.50	49.20	19.03	32500	19900	4000	2.7
118.0	82.5	49.5	101.0	29.0	49.5	37.0	17.50	49.20	19.04	32500	20500	3700	2.8
118.0	82.5	49.5	101.0	29.0	49.5	37.0	17.50	51.60	19.04	35000	23200	3400	2.8
146.0	101.0	64.0	130.0	35.0	63.5	46.5	27.00	55.60	22.24	43500	29200	3100	4.2
146.0	101.0	64.0	130.0	35.0	63.5	46.5	27.00	65.10	25.44	48000	33000	2800	5.4
166.5	113.0	70.0	150.8	42.0	70.0	50.5	27.00	74.60	30.24	61000	45000	2450	7.9
166.5	113.0	70.0	150.8	42.0	70.0	50.5	27.00	77.80	33.34	66000	49500	2300	8.4
184.0	113.0	70.0	165.1	42.0	70.0	54.0	27.00	82.60	33.34	71500	54500	2150	9.0
198.5	124.0	73.0	173.0	47.5	79.5	68.5	46.05	85.70	34.15	83000	64000	2000	13.7
216.0	127.0	73.0	190.5	47.5	79.5	69.5	46.05	96.00	39.74	96000	71500	1900	16.8
260.5	152.5	85.5	235.0	54.5	98.5	83.0	55.55	117.48	49.31	157000	122000	1600	22.2

Self-Lube cast iron take-up bearing units with adapter sleeves

MST 1000-K Series

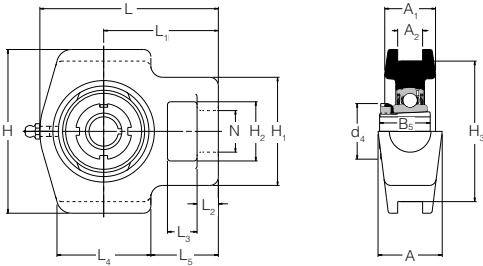

MST1000-K

Shaft diameter	RHP designation complete unit	Sleeve, nut & lockwasher only	Units without sleeve, nut & lockwasher	Basic bearing	Casting group insert	Dimensions (mm)					
						L	L1	L2	L3	L4	L5
20	MST1025-20K	H305	MST1025K	1025	ST3	98.0	62.0	11.5	16.0	50.5	36.5
¾	MST1025-¾K	HE305-¾									
25	MST1030-25K	H306	MST1030K	1030	1	115.5	71.7	12.5	16.5	64.5	43.0
15/16	MST1030-15/16K	HE306-15/16									
1	MST1030-1K	HE306-1									
30	MST1035-30K	H307	MST1035K	1035	2	124.0	75.5	12.5	16.5	64.5	43.0
1½	MST1035-1½K	HE307-1½									
1¾	MST1035-1¾K	HE307-1¾									
35	MST1040-35K	H308	MST1040K	1040	3	143.5	89.2	15.5	20.5	81.5	50.5
1¼	MST1040-1¼K	HE308-1¼									
1¾	MST1040-1¾K	HE308-1¾									
40	MST1045-40K	H309	MST1045K	1045	4	147.0	89.2	15.5	20.5	81.5	50.5
17/16	MST1045-17/16K	HE309-17/16									
1½	MST1045-1½K	HE309-1½									
45	MST1050-45K	H310	MST1050K	1050	5	151.0	90.5	15.5	20.5	81.5	50.5
11/16	MST1050-11/16K	HE310-11/16									
1¾	MST1050-1¾K	HE310-1¾									
50	MST1055-50K	H311	MST1055K	1055	6	182.0	114.0	19.0	32.0	97.5	70.0
1½	MST1055-1½K	HE3011-1½									
2	MST1055-2K	HE3011-2									

Please check availability

Dimensions (mm)										ISO Load ratings		Rec max. speed	Mass (approx.)
H	H1	H2	H3	N	A	A1	A2	B5	d4	dynamic CR newtons	static Cor newtons	rev/min	kg
88.5	58.5	32.0	76.0	22.5	36.0	27.5	13.50	29.0	38.0	14000	7880	6250	1.0
101.5	64.5	37.5	89.0	22.5	36.5	30.0	13.50	31.0	45.0	19500	11300	5300	1.6
101.5	64.5	37.5	89.0	22.5	36.5	30.0	13.50	35.0	52.0	25700	15300	4500	1.6
118.0	82.5	49.5	101.0	29.0	49.5	37.0	17.50	36.0	58.0	32500	19900	4000	2.7
118.0	82.5	49.5	101.0	29.0	49.5	37.0	17.50	39.0	65.0	32500	20500	3700	2.8
118.0	82.5	49.5	101.0	29.0	49.5	37.0	17.50	42.0	70.0	35000	23200	3400	2.8
146.0	101.0	64.0	130.0	35.0	63.5	46.5	27.00	45.0	75.0	43500	29200	3100	4.2

Self-Lube cast iron conveyor belt tensioner units

BT Series

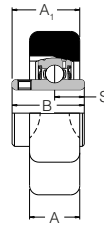
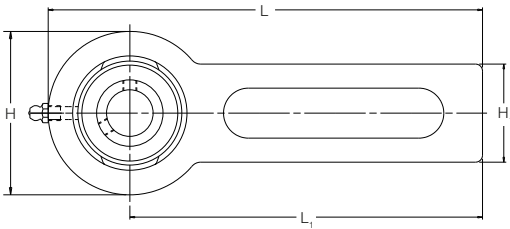

BT

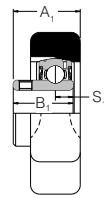

BT-A

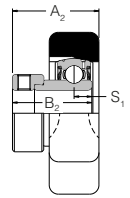

BT-EC

Shaft diameter		RHP designation			Basic bearing insert	Casting group	Dimensions (mm)			
mm	inches						H	H1	L	L1
25		BT25	BT25A	BT25EC	1025	3	78.0	42.5	264.0	225.0
	7/8	BT7/8		BT7/8EC						
	15/16	BT15/16		BT15/16EC						
	1	BT1	BT1A	BT1EC						
30		BT30L			1035	5	98.0	42.5	274.0	225.0
35		BT35	BT35A	BT35EC						
	13/16	BT13/16L								
	1/4	BT1/4	BT1/4A	BT1/4EC						
	13/8	BT13/8		BT13/8EC						
	1/16	BT1/16		BT1/16EC						
	1/16	BT1/16		BT1/16EC						

Please check availability

Bearing inserts with flinger seals shown on pages 89 and 90 can be fitted into these housings. The unit reference has the suffix 'FS', e.g. BT35FS.

Triple seal bearing inserts shown on pages 86 to 88 can be fitted into these housings. The unit reference has a prefix 'T', e.g. TBT35.

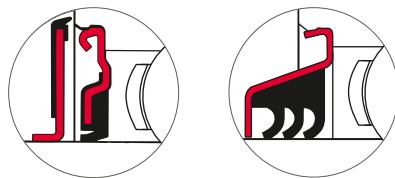

Dimensions (mm)								ISO Load ratings		Rec. max. speed rev/min	Mass (approx.) kg
A	A1	A2	B	B1	B2	s	s1	dynamic Cr newtons	static Cor newtons		
22.0	30.57	34.20	34.10	27.30	31.03	14.33	7.53	14000	7880	6250	1.8
22.0	36.13	40.20	42.90	34.90	38.93	17.53	9.53	25700	15300	4500	2.3

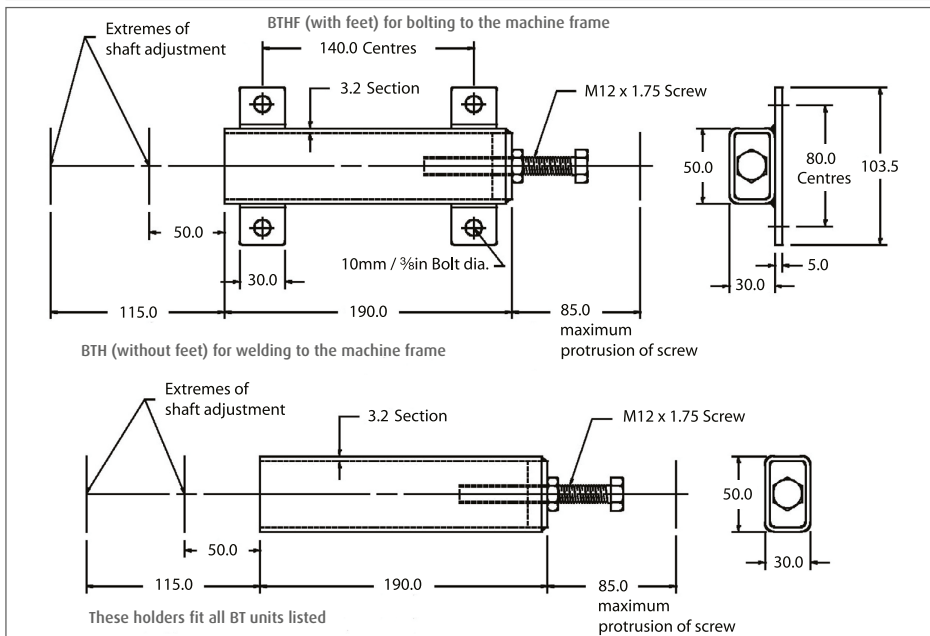

Self-Lube cast iron cartridge bearing units

SLC Series

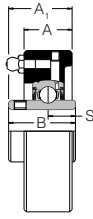
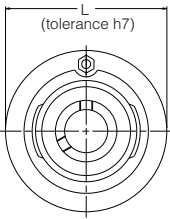

SLC

For housing tolerances to suit outside dia 'L' see page 19

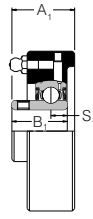

SLC-A

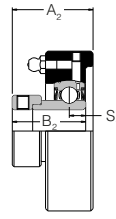

SLC-EC

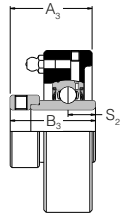

SLC-DEC

Shaft diameter		RHP designation				Basic bearing insert	Casting group	Dimensions (mm)			
mm	inches							L	A	A1	A2
12		SLC12		SLC12EC		1017	1	68.287	22.22	24.21	30.35
15		SLC15		SLC15EC							
16		SLC16		SLC16EC							
17		SLC17		SLC17EC							
	1/2	SLC1/2		SLC1/2EC							
	5/8	SLC5/8		SLC5/8EC							
20		SLC20	SLC20A	SLC20EC	SLC20DEC	1020	2	74.367	22.22	29.39	34.54
	3/4	SLC3/4		SLC3/4EC	SLC3/4DEC						
25		SLC25	SLC25A	SLC25EC	SLC25DEC	1025	3	79.400	26.19	32.94	36.52
	7/8	SLC7/8		SLC7/8EC	SLC7/8DEC						
	15/16	SLC15/16		SLC15/16EC	SLC15/16DEC						
	1	SLC1	SLC1A	SLC1EC	SLC1DEC						
30		SLC30	SLC30A	SLC30EC	SLC30DEC	1030	4	88.925	27.78	36.12	40.56
	1 1/8	SLC1 1/8		SLC1 1/8EC	SLC1 1/8DEC						
	1 3/16	SLC1 3/16		SLC1 3/16EC	SLC1 3/16DEC						
	1 1/4	SLC1 1/4R	SLC1 1/4AR	SLC1 1/4ECR	SLC1 1/4DEC						
35		SLC35	SLC35A	SLC35EC	SLC35DEC	1035	5	98.450	30.96	40.87	44.81
	1 1/4	SLC1 1/4	SLC1 1/4A	SLC1 1/4EC	SLC1 1/4DEC						
	1 3/8	SLC1 3/8		SLC1 3/8EC	SLC1 3/8DEC						
	1 7/16	SLC1 7/16		SLC1 7/16EC	SLC1 7/16DEC						
40		SLC40	SLC40A	SLC40EC	SLC40DEC	1040	6	106.387	37.31	48.84	51.28
	1 1/2	SLC1 1/2	SLC1 1/2A	SLC1 1/2EC	SLC1 1/2DEC						
45		SLC45	SLC45A	SLC45EC	SLC45DEC	1045	7	111.150	36.51	48.44	50.88
	1 5/8	SLC1 5/8		SLC1 5/8EC	SLC1 5/8DEC						
	1 11/16	SLC1 11/16		SLC1 11/16EC	SLC1 11/16DEC						
	1 3/4	SLC1 3/4	SLC1 3/4A	SLC1 3/4EC	SLC1 3/4DEC						
50		SLC50	SLC50A	SLC50EC	SLC50DEC	1050	8	115.913	37.31	51.18	51.28
	1 7/8	SLC1 7/8		SLC1 7/8EC	SLC1 7/8DEC						
	1 15/16	SLC1 15/16		SLC1 15/16EC	SLC1 15/16DEC						
	2	SLC2R									
55		SLC55			SLC55DEC	1055	9	125.437	40.48	53.57	-
	2	SLC2			SLC2DEC						
	2 1/8	SLC2 1/8			SLC2 1/8DEC						
	2 1/16	SLC2 1/16			SLC2 1/16DEC						
60		SLC60			SLC60DEC	1060	10	149.250	41.28	60.30	-
	2 1/4	SLC2 1/4			SLC2 1/4DEC						
	2 3/8	SLC2 3/8			SLC2 3/8DEC						
	2 7/16	SLC2 7/16			SLC2 7/16DEC						
65		SLC65				1065	10/65	149.250	41.28	60.30	-
	2 1/2	SLC2 1/2			SLC2 1/2DEC						

Please check availability

Bearing inserts with flinger seals shown on pages 89 and 90 can be fitted into these housings. The unit reference has the suffix 'FS', e.g. SLC25FS.

Triple seal bearing inserts shown on pages 86 to 88 can be fitted into these housings. The unit reference has a prefix 'T', e.g. TSLC25.

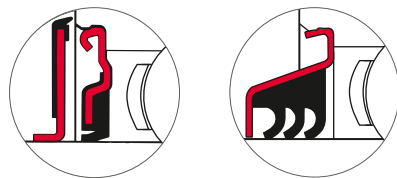

Dimensions (mm)								ISO Load ratings		Rec. max. speed	Mass (approx.)
A3	B	B1	B2	B3	s	s1	s2	dynamic Cr newtons	static Cor newtons	rev/min	kg
-	27.38	-	28.63	-	11.58	6.53	-	9550	4800	7000	0.6
37.67	31.00	25.80	31.03	43.73	12.73	7.53	17.13	12800	6650	6700	0.7
40.06	34.10	27.30	31.03	44.43	14.33	7.53	17.53	14000	7880	6250	0.8
43.99	38.10	31.20	35.73	48.43	15.93	9.03	18.33	19500	11300	5300	1.1
47.78	42.90	34.90	38.93	51.13	17.53	9.53	18.83	25700	15300	4500	1.4
53.57	49.20	41.20	43.73	56.33	19.03	11.03	21.43	32500	19900	4000	2.0
53.16	49.20	41.20	43.73	56.33	19.04	11.04	21.43	32500	20500	3700	2.1
56.72	51.60	43.50	43.73	62.73	19.04	11.04	24.64	35000	23200	3400	2.3
63.83	55.60	-	-	71.42	22.24	-	27.82	43500	29200	3100	2.9
67.39	65.10	-	-	77.84	25.44	-	31.04	48000	33000	2800	4.4
67.39	65.10	-	-	85.74	25.44	-	34.14	57500	40000	2600	4.5

Self-Lube cast iron cartridge bearing units

MSC Series

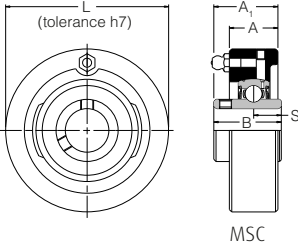

For housing tolerances
to suit outside dia 'L' see
page 19

Shaft diameter		RHP designation	Basic bearing insert	Casting group	Dimensions (mm)	
mm	inches				L	A
25		MSC25	1030	1	88.925	27.78
30		**				
	1	MSC1				
		**				
35		MSC1	1035	2	98.450	30.96
	1 ³ / ₁₆	MSC1 ³ / ₁₆				
	1 ¹ / ₄	**				
40		**	1040	3	106.387	37.31
	1 ³ / ₈	MSC1 ³ / ₈				
	1 ⁷ / ₁₆	MSC1 ⁷ / ₁₆				
45		**	1045	4	111.150	36.51
	1 ¹ / ₂	MSC1 ¹ / ₂				
50		**	1050	5	115.913	37.31
	1 ¹¹ / ₁₆	MSC1 ¹¹ / ₁₆				
	1 ³ / ₄	MSC1 ³ / ₄				
55		**	1055	6	125.437	40.48
	1 ⁷ / ₈	MSC1 ⁷ / ₈				
	1 ¹⁵ / ₁₆	MSC1 ¹⁵ / ₁₆				
	2	**				
60		**	1060	7	149.250	41.28
	2 ³ / ₁₆	MSC2 ³ / ₁₆				
	2 ¹ / ₄	**				
65		MSC65	1070	8	158.775	50.80
70		MSC70				
	2 ⁷ / ₁₆	MSC2 ⁷ / ₁₆				
	2 ¹ / ₂	MSC2 ¹ / ₂				
75		MSC75	1075	9	168.300	50.80
	2 ¹¹ / ₁₆	MSC2 ¹¹ / ₁₆				
	2 ³ / ₄	MSC2 ³ / ₄				
80		MSC80	1080	10	177.825	55.56
	2 ¹⁵ / ₁₆	MSC2 ¹⁵ / ₁₆				
	3	MSC3				
85		MSC85	1085	11	188.937	63.50
	3 ³ / ₁₆	MSC3 ³ / ₁₆				
	3 ¹ / ₄	MSC3 ¹ / ₄				
90		MSC90	1090	12	207.987	63.50
	3 ⁷ / ₁₆	MSC3 ⁷ / ₁₆				
	3 ¹ / ₂	MSC3 ¹ / ₂				
95		MSC95	3095	13	241.325	76.20
100		MSC100				
	3 ¹⁵ / ₁₆	MSC3 ¹⁵ / ₁₆				
	4	MSC4				

Please check availability

** For these bore sizes select from SLC Series (see page 62)

Bearing inserts with flinger seals shown on pages 89 and 90 can be fitted into these housings. The unit reference has the suffix 'FS', e.g. MSC 1 3/16 FS.

Triple seal bearing inserts shown on pages 86 to 88 can be fitted into these housings. The unit reference has a prefix 'T', e.g. TMSC 1 3/16.

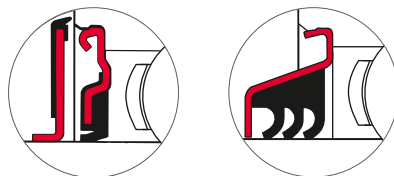

A1	B	s	ISO Load ratings		Rec. max. speed rev/min	Mass (approx.) kg
			dynamic Cr newtons	static Cor newtons		
36.12	38.10	15.93	19500	11300	5300	1.1
40.87	42.90	17.53	25700	15300	4500	1.4
48.84	49.20	19.03	32500	19900	4000	2.0
48.44	49.20	19.04	32500	20500	3700	2.1
51.18	51.60	19.04	35000	23200	3400	2.3
53.57	55.60	22.24	43500	29200	3100	2.9
60.30	65.10	25.44	48000	33000	2800	4.4
69.80	74.60	30.24	61000	45000	2450	5.3
69.80	77.80	33.34	66000	49500	2300	6.2
76.99	82.60	33.34	71500	54500	2150	7.9
83.29	85.70	34.15	83000	64000	2000	9.3
88.06	96.00	39.74	96000	71500	1900	12.7
106.38	117.48	49.31	157000	122000	1600	20.4

Self-Lube cast iron hanger bearing units

SCHB Series (BSP thread), SCH Series (metric thread)**

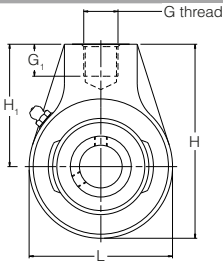

SCHB (BSP thread)
SCH (metric thread)

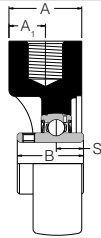

Shaft diameter		RHP designation		Basic bearing insert	Casting group	Dimensions (mm)				
mm	inches					G (BSP)	G (metric)	G1 (mm)	L	
20		SCHB20	SCH20	1020	0	½	M16 x 2.00	19.0	67.0	
		¾	SCHB¾							SCH¾
25		SCHB25	SCH25	1030	2/0	½	M20 x 2.50	16.0	89.0	
30		SCHB30	SCH30							
	⅞	SCHB⅞	SCH⅞							
	1	SCHB1	SCH1							
	1⅛	SCHB1⅛	SCH1⅛							
35		SCHB35	SCH35	1035	1	¾	M24 x 3.00	19.0	97.0	
		1⅜	SCHB1⅜							SCH1⅜
		1¼	SCHB1¼							SCH1¼
	1⅝	SCHB1⅝	SCH1⅝							
40		SCHB40	SCH40	1040	2	¾	M24 x 3.00	19.0	107.0	
		1⅞	SCHB1⅞							SCH1⅞
		1½	SCHB1½							SCH1½
45		SCHB45	SCH45	1050	3	1	M24 x 3.00	21.0	121.0	
	50		SCHB50							SCH50
	1⅞	SCHB1⅞	SCH1⅞							
	1¾	SCHB1¾	SCH1¾							
	1⅞	SCHB1⅞	SCH1⅞							
	1⅞	SCHB1⅞	SCH1⅞							
	2	SCHB2	SCH2							
55		SCHB55	SCH55	1060	4	1¼	M42 x 4.50	29.0	146.5	
60		SCHB60	SCH60							
	2⅜	SCHB2⅜	SCH2⅜							
	2¼	SCHB2¼	SCH2¼							
	2⅝	SCHB2⅝	SCH2⅝							
	2⅞	SCHB2⅞	SCH2⅞							
	2½	SCHB2½	SCH2½	1065	4/65	1¼	M42 x 4.50	29.0	143.0	
65		SCHB65	SCH65	1075	5	1½	M48 x 5.00	32.0	165.0	
70		SCHB70	SCH70							
75		SCHB75	SCH75							
	2⅞	SCHB2⅞	SCH2⅞							
	2⅞	SCHB2⅞	SCH2⅞							
	2⅞	SCHB2⅞	SCH2⅞							
	2⅞	SCHB2⅞	SCH2⅞							
	2⅞	SCHB2⅞	SCH2⅞							
80		SCHB80	SCH80	1080	6	1½	M48 x 5.00	32.0	174.5	
		3	SCHB3							SCH3
		3⅞	SCHB3⅞							SCH3⅞

Please check availability

**These series units are identical to SCHB series except for thread details

Bearing inserts with flinger seals shown on pages 89 and 90 can be fitted into these housings. The unit reference has the suffix 'FS', e.g. SCHB35FS.

Triple seal bearing inserts shown on pages 86 to 88 can be fitted into these housings. The unit reference has a prefix 'T', e.g. TSCHB35.

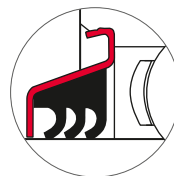
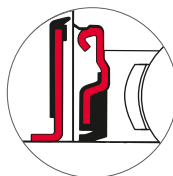

Dimensions (mm)						ISO Load ratings		Rec. max. speed rev/min	Mass (approx.) kg
H	H1	A	A1	B	s	dynamic Cr newtons	static Cor newtons		
91.6	57.2	34.0	18.26	30.96	12.75	12800	6650	6700	0.8
107.5	61.9	33.5	22.22	38.10	15.93	19500	11300	5300	1.2
119.0	69.8	39.5	25.40	42.88	17.53	25700	15300	4500	1.5
127.5	73.0	39.5	27.79	49.23	19.10	32500	19900	4000	1.6
144.0	82.6	47.5	27.79	51.59	19.10	35000	23200	3400	2.2
175.0	101.6	58.5	30.94	65.07	25.45	48000	33000	2800	3.5
173.5	101.6	58.5	30.94	65.07	25.45	57500	40000	2600	3.4
200.6	117.5	70.0	34.94	77.77	33.37	66000	49500	2300	6.8
211.5	123.8	71.5	41.29	82.55	33.37	71500	54500	2150	8.1

Self-Lube pressed steel flange bearing units (zinc plated housings)

SLFE Series**

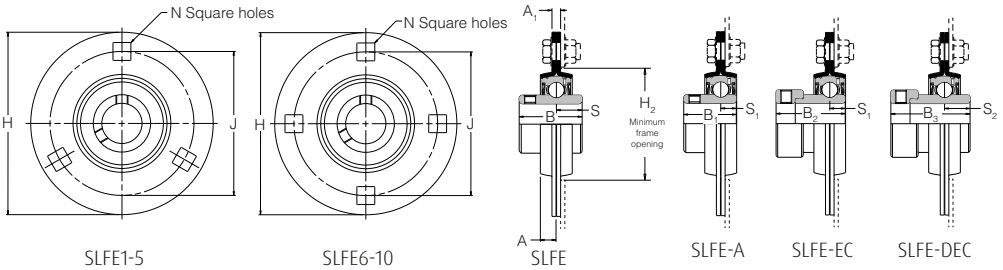

Shaft diameter		RHP designation				Basic bearing insert	Casting group	Dimensions (mm)			
mm	inches							H	H2	J	N
12		SLFE12		SLFE12EC		1017	1	81.0	49.0	63.5	7.1
15		SLFE15		SLFE15EC							
16		SLFE16		SLFE16EC							
17		SLFE17		SLFE17A							
	1/2	SLFE1/2		SLFE1/2EC							
	5/8	SLFE5/8		SLFE5/8EC							
20		SLFE20	SLFE20A	SLFE20EC	SLFE20DEC	1020	2	90.5	55.0	71.5	8.7
	3/4	SLFE3/4	SLFE3/4A	SLFE3/4EC	SLFE3/4DEC						
25		SLFE25	SLFE25A	SLFE25EC	SLFE25DEC	1025	3	95.2	60.0	76.0	8.7
	7/8	SLFE7/8		SLFE7/8EC	SLFE7/8DEC						
	15/16	SLFE15/16		SLFE15/16EC	SLFE15/16DEC						
	1	SLFE1	SLFE1A	SLFE1EC	SLFE1DEC						
30		SLFE30	SLFE30A	SLFE30EC	SLFE30DEC	1030	4	112.7	71.0	90.5	10.5
	1 1/8	SLFE1 1/8		SLFE1 1/8EC	SLFE1 1/8DEC						
	1 1/16	SLFE1 1/16		SLFE1 1/16EC	SLFE1 1/16DEC						
	1 1/4	SLFE1 1/4	SLFE1 1/4A	SLFE1 1/4EC	SLFE1 1/4DEC						
35	1 1/4	SLFE1 1/4L	SLFE1 1/4AL	SLFE1 1/4ECL	SLFE1 1/4DECL	1035	5	122.2	81.0	100.0	10.5
	35	SLFE35	SLFE35A	SLFE35EC	SLFE35DEC						
	1 3/8	SLFE1 3/8		SLFE1 3/8EC	SLFE1 3/8DEC						
	1 7/16	SLFE1 7/16		SLFE1 7/16EC	SLFE1 7/16DEC						
40		SLFE40	SLFE40A	SLFE40EC	SLFE40DEC	1040	6	147.8	91.0	119.0	13.5
	1 1/2	SLFE1 1/2	SLFE1 1/2A	SLFE1 1/2EC	SLFE1 1/2DEC						
45		SLFE45	SLFE45A	SLFE45EC	SLFE45DEC	1045	7	149.2	97.0	120.5	13.5
	1 5/8	SLFE1 5/8		SLFE1 5/8EC	SLFE1 5/8DEC						
	1 11/16	SLFE1 11/16		SLFE1 11/16EC	SLFE1 11/16DEC						
	1 3/4	SLFE1 3/4	SLFE1 3/4A	SLFE1 3/4EC	SLFE1 3/4DEC						
50		SLFE50	SLFE50A	SLFE50EC	SLFE50DEC	1050	8	155.6	102.0	127.0	13.5
	1 7/8	SLFE1 7/8		SLFE1 7/8EC	SLFE1 7/8DEC						
	1 15/16	SLFE1 15/16		SLFE1 15/16EC	SLFE1 15/16DEC						
	2	SLFE2R									
55		SLFE55		SLFE55DEC		1055	9	166.6	113.0	138.0	13.5
	2	SLFE2		SLFE2DEC							
	2 1/8	SLFE2 1/8		SLFE2 1/8DEC							
	2 3/16	SLFE2 3/16		SLFE2 3/16DEC							
60		SLFE60		SLFE60DEC		1060	10	176.2	122.0	147.6	13.5
	2 1/4	SLFE2 1/4		SLFE2 1/4DEC							
	2 7/16	SLFE2 7/16		SLFE2 7/16DEC							

Please check availability

A modified version of these units is available if a Protector is to be fitted, see page 91 for details

**Housings of groups 6 to 10 inclusive have four bolt holes. Note: These units are not re-greaseable

Bearing inserts with flinger seals shown on pages 89 and 90 can be fitted into these housings. The unit reference has the suffix 'FS', e.g. SLFE25FS.

Triple seal bearing inserts shown on pages 86 to 88 can be fitted into these housings. The unit reference has a prefix 'T', e.g. TSLFE25.

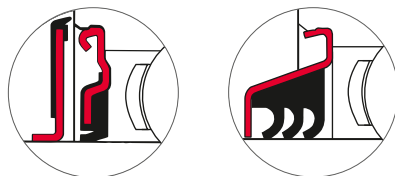

Dimensions (mm)									Max. radial housing load newtons	Rec. max. speed rev/min	Mass (approx.) kg
A	A1	B	B1	B2	B3	s	s1	s2			
6.7	4.0	27.38	-	28.63	-	11.58	6.53	-	2670	3000	0.2
7.7	4.0	31.00	25.80	31.03	43.73	12.73	7.53	17.13	3110	3000	0.3
8.7	4.0	34.10	27.30	31.03	44.43	14.33	7.53	17.53	3560	2500	0.4
9.0	5.0	38.10	31.20	35.73	48.43	15.93	9.03	18.33	4890	2500	0.7
10.0	5.0	42.90	34.90	38.93	51.13	17.53	9.53	18.83	6250	2000	0.9
10.0	7.0	49.20	41.20	43.73	56.33	19.03	11.03	21.43	7550	2000	1.5
10.0	7.0	49.20	41.20	43.73	56.33	19.04	11.04	21.43	7550	2000	1.6
10.5	8.0	51.60	43.50	43.73	62.73	19.04	11.04	24.64	8450	1500	1.8
10.7	8.0	55.60	-	-	71.42	22.24	-	27.84	10200	1500	2.2
11.9	8.0	65.10	-	-	77.84	25.44	-	31.04	11300	1500	2.5

Self-Lube pressed steel flange bearing units (zinc plated housings)

SLFT Series**

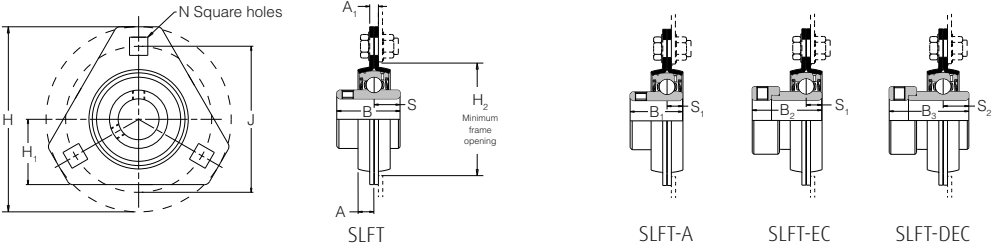

Shaft diameter		RHP designation				Basic bearing insert	Casting group	Dimensions (mm)				
mm	inches							H	H1	H2	J	N
25		SLFT25	SLFT25A	SLFT25EC	SLFT25DEC	1025	3	95.2	34.2	60.0	76.0	8.7
	7/8	SLFT7/8		SLFT7/8EC	SLFT7/8DEC							
	15/16	SLFT15/16		SLFT15/16EC	SLFT15/16DEC							
	1	SLFT1	SLFT1A	SLFT1EC	SLFT1DEC							
30		SLFT30	SLFT30A	SLFT30EC	SLFT30DEC	1030	4	112.7	40.2	71.0	90.5	10.5
	1 1/8	SLFT1 1/8		SLFT1 1/8EC	SLFT1 1/8DEC							
	1 3/16	SLFT1 3/16		SLFT1 3/16EC	SLFT1 3/16DEC							
	1/4	SLFT1/4	SLFT1/4A	SLFT1/4EC	SLFT1/4DEC							
35		SLFT35	SLFT35A	SLFT35EC	SLFT35DEC	1035	5	122.2	44.2	81.0	100.0	10.5
	1 1/4	SLFT1 1/4L	SLFT1 1/4AL	SLFT1 1/4ECL	SLFT1 1/4DECL							
	1 3/8	SLFT1 3/8		SLFT1 3/8EC	SLFT1 3/8DEC							
	1 7/16	SLFT1 7/16		SLFT1 7/16EC	SLFT1 7/16DEC							

Please check availability

A modified version of these units is available if a Protector is to be fitted, see page 91 for details

**Note: These units are not re-greaseable

Bearing inserts with flinger seals shown on pages 89 and 90 can be fitted into these housings. The unit reference has the suffix 'FS', e.g. SLFT25FS.

Triple seal bearing inserts shown on pages 86 to 88 can be fitted into these housings. The unit reference has a prefix 'T', e.g. TSLFT25.

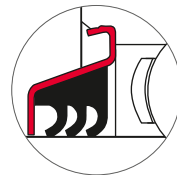
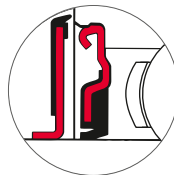

Dimensions (mm)									Max. radial housing load newtons	Rec. max. speed rev/min	Mass (approx.) kg
A	A1	B	B1	B2	B3	s	s1	s2			
8.7	4.0	34.11	27.35	30.92	44.40	14.33	7.56	17.49	3560	2500	0.3
9.0	5.0	38.10	31.21	35.68	48.42	15.93	9.03	18.33	4890	2500	0.5
10.0	5.0	42.88	34.90	38.88	51.18	17.53	9.55	18.89	6250	2000	0.7

Self-Lube pressed steel flange bearing units (zinc plated housings)

SLFL Series**

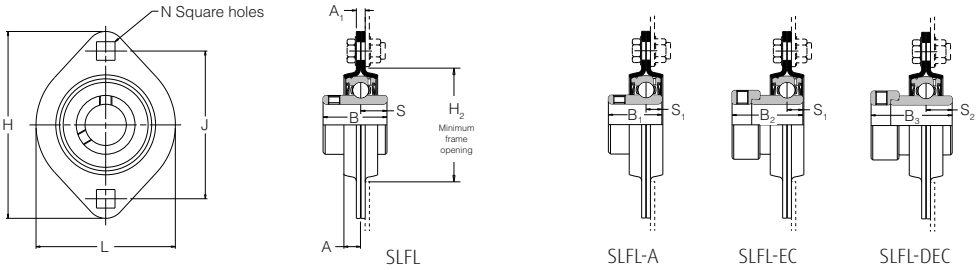

Shaft diameter		RHP designation				Basic bearing insert	Casting group	Dimensions (mm)				
mm	inches							L	H	H2	J	N
12		SLFL12		SLFL12EC		1017	1	58.7	81.0	49.0	63.5	7.1
15		SLFL15		SLFL15EC								
16		SLFL16		SLFL16EC								
17		SLFL17		SLFL17EC								
	1/2	SLFL1/2		SLFL1/2EC								
	3/8	SLFL3/8		SLFL3/8EC								
20		SLFL20	SLFL20A	SLFL20EC	SLFL20DEC	1020	2	66.7	90.5	55.0	71.5	8.7
	3/4	SLFL3/4	SLFL3/4A	SLFL3/4EC	SLFL3/4DEC							
25		SLFL25	SLFL25A	SLFL25EC	SLFL25DEC	1025	3	71.0	95.3	60.0	76.0	8.7
	7/8	SLFL7/8		SLFL7/8EC	SLFL7/8DEC							
	15/16	SLFL15/16		SLFL15/16EC	SLFL15/16DEC							
	1	SLFL1	SLFL1A	SLFL1EC	SLFL1DEC							
30		SLFL30	SLFL30A	SLFL30EC	SLFL30DEC	1030	4	84.1	112.7	71.0	90.5	10.5
	1 1/8	SLFL1 1/8		SLFL1 1/8EC	SLFL1 1/8DEC							
	1 3/16	SLFL1 3/16		SLFL1 3/16EC	SLFL1 3/16DEC							
	1 1/4	SLFL1 1/4	SLFL1 1/4A	SLFL1 1/4EC	SLFL1 1/4DEC							

Please check availability

A modified version of these units is available if a Protector is to be fitted, see page 91 for details

**Note: These units are not re-greaseable

Bearing inserts with flinger seals shown on pages 89 and 90 can be fitted into these housings. The unit reference has the suffix 'FS', e.g. SLFL1FS.

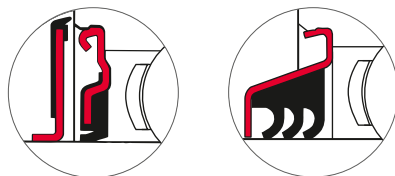

Triple seal bearing inserts shown on pages 86 to 88 can be fitted into these housings. The unit reference has a prefix 'T', e.g. TSLFL1.

Dimensions (mm)									Max. radial housing load newtons	Rec. max. speed rev/min	Mass (approx.) kg
A	A1	B	B1	B2	B3	s	s1	s2			
6.7	4.0	27.38	-	28.54	-	11.55	6.55	-	2670	3000	0.2
7.7	4.0	30.96	25.77	30.92	43.62	12.73	7.56	17.13	3110	3000	0.3
8.7	4.0	34.11	27.35	30.92	44.40	14.33	7.56	17.49	3560	2500	0.3
9.0	5.0	38.10	31.21	35.68	48.42	15.93	9.04	18.32	4890	2500	0.5

Self-Lube pressed steel pillow block units (zinc plated housings)

LPB Series**

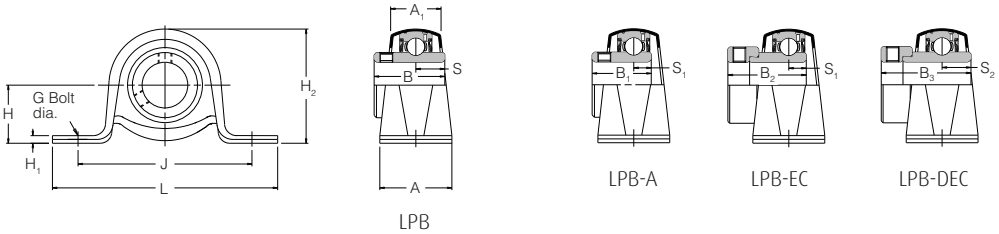

Shaft diameter		RHP designation				Basic bearing insert	Casting group	Dimensions (mm)						
mm	inches							L	H	H1	H2	J		
12		LPB12		LPB12EC		1017	1	85.7	22.2	2.4	43.2	68.0		
15		LPB15		LPB15EC										
16		LPB16		LPB16EC										
17		LPB17		LPB17EC										
	1/2	LPB1/2		LPB1/2EC										
	3/8	LPB3/8		LPB3/8EC										
20		LPB20	LPB20A	LPB20EC	LPB20DEC	1020	2	98.4	25.4	2.4	49.9	76.0		
	3/4	LPB3/4	LPB3/4A	LPB3/4EC	LPB3/4DEC									
25		LPB25	LPB25A	LPB25EC	LPB25DEC	1025	3	108.0	28.6	2.8	55.8	86.0		
	7/8	LPB7/8		LPB7/8EC	LPB7/8DEC									
	15/16	LPB15/16		LPB15/16EC	LPB15/16DEC									
	1	LPB1	LPB1A	LPB1EC	LPB1DEC									
30		LPB30	LPB30A	LPB30EC	LPB30DEC	1030	4	117.5	33.3	3.6	65.7	95.0		
	1 1/8	LPB1 1/8		LPB1 1/8EC	LPB1 1/8DEC									
	1 3/16	LPB1 3/16		LPB1 3/16EC	LPB1 3/16DEC									
	1 1/4	LPB1 1/4	LPB1 1/4A	LPB1 1/4EC	LPB1 1/4DEC									
35		LPB35	LPB35A	LPB35EC	LPB35DEC	1035	5	128.6	39.7	4.4	77.5	106.0		
	1 1/4	LPB1 1/4L	LPB1 1/4AL	LPB1 1/4ECL	LPB1 1/4DECL									
	1 3/8	LPB1 3/8		LPB1 3/8EC	LPB1 3/8DEC									
	1 7/16	LPB1 7/16		LPB1 7/16EC	LPB1 7/16DEC									

Please check availability

**Note: These units are not re-greaseable

G	Dimensions (mm)									Max. radial housing load newtons	Rec. max. speed rev/min	Mass (approx.) kg
	A	A1	B	B1	B2	B3	s	s1	s2			
8	25.4	15.9	27.38	-	28.54	-	11.55	6.55	-	1330	3000	0.2
8	31.7	21.6	30.96	25.77	30.92	43.62	12.73	7.56	17.13	1570	3000	0.2
10	31.7	21.6	34.11	27.35	30.92	44.40	14.33	7.56	17.49	1780	2500	0.3
10	37.5	25.5	38.10	31.21	35.68	48.42	15.93	9.04	18.32	2670	2500	0.5
10	41.0	28.4	42.88	34.90	38.88	51.18	17.53	9.55	18.89	3560	2000	0.9

Self-Lube pressed steel rubber mounted pillow block units (zinc plated housings)

LPBR Series**

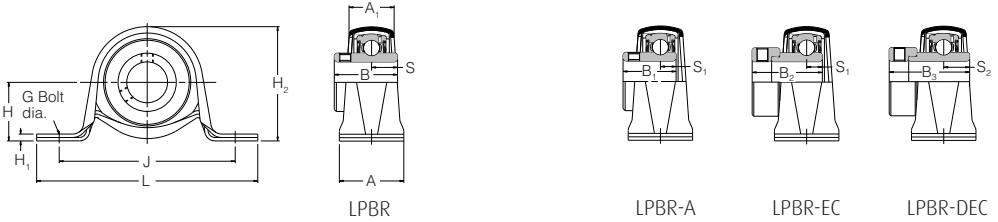

Shaft diameter		RHP designation				Basic bearing insert	Casting group	Dimensions (mm)				
mm	inches							L	H	H1	H2	J
12		LPBR12		LPBR12EC		1017	2	98.4	25.4	2.4	49.9	76.0
15		LPBR15		LPBR15EC								
16		LPBR16		LPBR16EC								
17		LPBR17		LPBR17EC								
	1/2	LPBR1/2		LPBR1/2EC								
	3/8	LPBR3/8		LPBR3/8EC								
20		LPBR20	LPBR20A	LPBR20EC	LPBR20DEC	1020	3	108.0	28.6	2.8	55.8	86.0
	3/4	LPBR3/4	LPBR3/4A	LPBR3/4EC	LPBR3/4DEC							
25		LPBR25	LPBR25A	LPBR25EC	LPBR25DEC	1025	4	117.5	33.3	3.6	65.7	95.0
	7/8	LPBR7/8		LPBR7/8EC	LPBR7/8DEC							
	15/16	LPBR15/16		LPBR15/16EC	LPBR15/16DEC							
	1	LPBR1	LPBR1A	LPBR1EC	LPBR1DEC							
30		LPBR30	LPBR30A	LPBR30EC	LPBR30DEC	1030	5	128.6	39.7	4.4	77.5	106.0
	1 1/8	LPBR1 1/8		LPBR1 1/8EC	LPBR1 1/8DEC							
	1 1/16	LPBR1 1/16		LPBR1 1/16EC	LPBR1 1/16DEC							
	1 1/4	LPBR1 1/4	LPBR1 1/4A	LPBR1 1/4EC	LPBR1 1/4DEC							

Please check availability

**Note: These units are not re-greaseable

G	Dimensions (mm)									Max. radial housing load newtons	Rec. max. speed rev/min	Mass (approx.) kg
	A	A1	B	B1	B2	B3	s	s1	s2			
8	31.7	21.6	27.38	-	28.54	-	11.55	6.55	-	890	3000	0.2
10	31.7	21.6	30.96	25.77	30.92	43.62	12.73	7.56	17.13	1110	3000	0.3
10	37.5	25.5	34.11	27.35	30.92	44.40	14.33	7.56	17.49	1330	2500	0.5
10	41.0	28.4	38.10	31.21	35.68	48.42	15.93	9.04	18.32	1560	2500	0.9

Self-Lube bearing inserts

1000G and 1100 Series

1000G

With spherical outside diameter and integral set screw lock

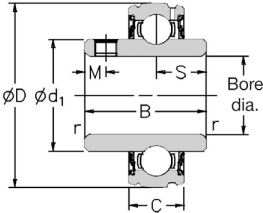

1100

With parallel outside diameter and integral set screw lock

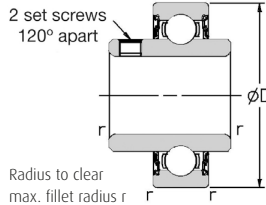

Shaft diameter mm inches	RHP designation		Dimensions (mm)						ISO Load ratings		Rec. max. speed rev/min	Mass (approx.) kg	
	1000G Series	1100 Series	D	C	B	s	d1	M	r	dynamic Cr newtons			static Cor newtons
12	1017-12G	1117-12	40.000	12.00	27.38	11.58	24.80	5.00	0.60	9550	4800	7000	0.09
15	1017-15G	1117-15											
16	1017-16G	1117-16											
17	1017-17G	1117-17											
1/2	1017-1/2G	1117-1/2											
3/8	1017-3/8G	1117-3/8											
20	1020-20G	1120-20	47.000	14.00	31.00	12.73	28.30	5.00	1.00	12800	6650	6700	0.13
3/4	1020-3/4G	1120-3/4											
25	1025-25G	1125-25	52.000	15.00	34.10	14.33	34.00	5.00	1.00	14000	7880	6250	0.17
7/8	1025-7/8G	1125-7/8											
15/16	1025-15/16G	1125-15/16											
1	1025-1G	1125-1											
25	1030-25G	1130-25	62.000	16.00	38.10	15.93	40.30	5.00	1.00	19500	11300	5300	0.37
30	1030-30G	1130-30											
1	1030-1G	1130-1											
1 1/8	1030-1 1/8G	1130-1 1/8											
1 3/16	1030-1 3/16G	1130-1 3/16											
1 1/4	1030-1 1/4G	1130-1 1/4											
30	1035-30G	1135-30	72.000	17.00	42.90	17.53	46.90	6.50	1.00	25700	15300	4500	0.51
35	1035-35G	1135-35											
1 3/16	1035-1 3/16G	1135-1 3/16											
1 1/4	1035-1 1/4G	1135-1 1/4											
1 5/16	1035-1 5/16G	1135-1 5/16											
1 3/8	1035-1 3/8G	1135-1 3/8											
1 1/2	1035-1 1/2G	1135-1 1/2											
35	1040-35G	1140-35	80.000	18.00	49.20	19.03	52.40	8.00	1.00	32500	19900	4000	0.64
40	1040-40G	1140-40											
1 3/8	1040-1 3/8G	1140-1 3/8											
1 7/16	1040-1 7/16G	1140-1 7/16											
1 1/2	1040-1 1/2G	1140-1 1/2											
40	1045-40G	1145-40	85.000	19.00	49.20	19.04	57.40	8.00	1.00	32500	20500	3700	0.73
45	1045-45G	1145-45											
1 1/2	1045-1 1/2G	1145-1 1/2											
1 5/8	1045-1 5/8G	1145-1 5/8											
1 11/16	1045-1 11/16G	1145-1 11/16											
1 3/4	1045-1 3/4G	1145-1 3/4											
45	1050-45G	1150-45	90.000	20.00	51.60	19.04	62.40	10.00	1.00	35000	23200	3400	0.91
50	1050-50G	1150-50											
1 11/16	1050-1 11/16G	1150-1 11/16											
1 3/4	1050-1 3/4G	1150-1 3/4											
1 7/8	1050-1 7/8G	1150-1 7/8											
1 5/8	1050-1 5/8G	1150-1 5/8											
2	1050-2G	1150-2											
50	1055-50G	1155-50	100.000	21.00	55.60	22.24	68.90	10.00	1.50	43500	29200	3100	1.12
55	1055-55G	1155-55											
1 7/8	1055-1 7/8G	1155-1 7/8											
1 5/8	1055-1 5/8G	1155-1 5/8											
2	1055-2G	1155-2											
2 1/8	1055-2 1/8G	1155-2 1/8											
2 3/16	1055-2 3/16G	1155-2 3/16											

Please check availability

Shaft diameter mm inches		RHP designation		Dimensions (mm)						ISO Load ratings		Rec. max. speed rev/min	Mass (approx.) kg	
		1000G Series	1100 Series	D	C	B	s	d1	M	r	dynamic newtons			Cr static newtons
55		1060-55G	1160-55	110.000	22.00	65.10	25.44	76.00	10.00	1.50	48000	33000	2800	1.47
60		1060-60G	1160-60											
	2 ³ / ₁₆	1060-2 ³ / ₁₆ G	1160-2 ³ / ₁₆											
	2 ¹ / ₄	1060-2 ¹ / ₄ G	1160-2 ¹ / ₄											
	2 ³ / ₈	1060-2 ³ / ₈ G	1160-2 ³ / ₈											
	2 ⁷ / ₁₆	1060-2 ⁷ / ₁₆ G	1160-2 ⁷ / ₁₆											
60		1065-60G	1165-60	120.000	23.00	65.10	25.44	82.50	10.00	1.50	57500	40000	2600	2.02
65		1065-65G	1165-65											
	2 ¹ / ₂	1065-2 ¹ / ₂ G	1165-2 ¹ / ₂											
60		1070-60G	1170-60	125.000	24.00	74.60	30.24	89.00	12.00	1.50	61000	45000	2450	2.27
65		1070-65G	1170-65											
70		1070-70G	1170-70											
	2 ⁷ / ₁₆	1070-2 ⁷ / ₁₆ G	1170-2 ⁷ / ₁₆											
	2 ¹ / ₂	1070-2 ¹ / ₂ G	1170-2 ¹ / ₂											
	2 ³ / ₈	1070-2 ³ / ₈ G	1170-2 ³ / ₈											
	2 ¹¹ / ₁₆	1070-2 ¹¹ / ₁₆ G	1170-2 ¹¹ / ₁₆											
65		1075-65G	1175-65	130.000	25.00	77.80	33.34	94.00	12.00	1.50	66000	49500	2300	2.61
70		1075-70G	1175-70											
75		1075-75G	1175-75											
	2 ¹¹ / ₁₆	1075-2 ¹¹ / ₁₆ G	1175-2 ¹¹ / ₁₆											
	2 ³ / ₄	1075-2 ³ / ₄ G	1175-2 ³ / ₄											
	2 ⁷ / ₈	1075-2 ⁷ / ₈ G	1175-2 ⁷ / ₈											
	2 ¹⁵ / ₁₆	1075-2 ¹⁵ / ₁₆ G	1175-2 ¹⁵ / ₁₆											
	3	1075-3G	1175-3											
75		1080-75G	1180-75	140.000	26.00	82.60	33.34	100.00	12.00	2.00	71500	54500	2150	3.23
80		1080-80G	1180-80											
	2 ¹⁵ / ₁₆	1080-2 ¹⁵ / ₁₆ G	1180-2 ¹⁵ / ₁₆											
	3	1080-3G	1180-3											
	3 ³ / ₁₆	1080-3 ³ / ₁₆ G	1180-3 ³ / ₁₆											
	3 ¹ / ₄	1080-3 ¹ / ₄ G	1180-3 ¹ / ₄											
80		1085-80G	1185-80	150.000	28.00	85.70	34.15	107.10	12.00	2.00	83000	64000	2000	3.74
85		1085-85G	1185-85											
	3 ³ / ₁₆	1085-3 ³ / ₁₆ G	1185-3 ³ / ₁₆											
	3 ¹ / ₄	1085-3 ¹ / ₄ G	1185-3 ¹ / ₄											
	3 ³ / ₈	1085-3 ³ / ₈ G	1185-3 ³ / ₈											
	3 ⁷ / ₁₆	1085-3 ⁷ / ₁₆ G	1185-3 ⁷ / ₁₆											
85		1090-85G	1190-85	160.000	30.00	96.00	39.74	111.50	15.00	2.00	96000	71500	1900	4.99
90		1090-90G	1190-90											
	3 ⁷ / ₁₆	1090-3 ⁷ / ₁₆ G	1190-3 ⁷ / ₁₆											
	3 ¹ / ₂	1090-3 ¹ / ₂ G	1190-3 ¹ / ₂											
95		3095-95G		200.000	45.00	117.48	49.31	127.10	16.00	2.50	157000	122000	1600	9.53
100		3095-100G												
	3 ¹⁵ / ₁₆	3095-3 ¹⁵ / ₁₆ G												
	4	3095-4G												

Self-Lube bearing inserts

1000DECG and 1100DEC Series

1000DECG

With spherical outside diameter and eccentric collar lock

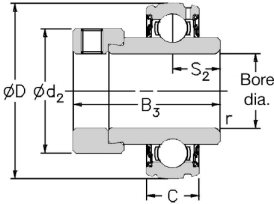

1100DEC

With parallel outside diameter and eccentric collar lock

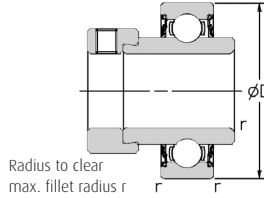

Shaft diameter mm inches	RHP designation		Dimensions (mm)							ISO Load ratings		Rec. max. speed rev/min	Mass (approx.) kg
	1000DECG Series	1100DEC Series	D	C	B3	s2	d2	r	dynamic Cr newtons	static Cor newtons			
20 3/4	1020-20DECG 1020-3/4DECG	1120-20DEC 1120-3/4DEC	47.000	14.00	43.73	17.13	33.30	1.00	12800	6650	6700	0.20	
25 7/8 15/16 1	1025-25DECG 1025-7/8DECG 1025-15/16DECG 1025-1DEC	1125-25DEC 1125-7/8DEC 1125-15/16DEC 1125-1DEC	52.000	15.00	44.43	17.53	38.10	1.00	14000	7880	6250	0.26	
30 1 1/8 1 1/16 1 1/4	1030-30DECG 1030-1 1/8DECG 1030-1 1/16DECG 1030-1 1/4DECG	1130-30DEC 1130-1 1/8DEC 1130-1 1/16DEC 1130-1 1/4DEC	62.000	16.00	48.43	18.33	44.50	1.00	19500	11300	5300	0.53	
35 1 1/4 1 3/8 1 7/16	1035-35DECG 1035-1 1/4DECG 1035-1 3/8DECG 1035-1 7/16DECG	1135-35DEC 1135-1 1/4DEC 1135-1 3/8DEC 1135-1 7/16DEC	72.000	17.00	51.13	18.83	55.60	1.00	25700	15300	4500	0.70	
40 1 1/2	1040-40DECG 1040-1 1/2DECG	1140-40DEC 1140-1 1/2DEC	80.000	18.00	56.33	21.43	60.30	1.00	32500	19900	4000	0.82	
45 1 7/8 1 11/16 1 3/4	1045-45DECG 1045-1 7/8DECG 1045-1 11/16DECG 1045-1 3/4DECG	1145-45DEC 1145-1 7/8DEC 1145-1 11/16DEC 1145-1 3/4DEC	85.000	19.00	56.33	21.43	63.50	1.00	32500	20500	3700	1.08	
50 1 7/8 1 15/16	1050-50DECG 1050-1 7/8DECG 1050-1 15/16DECG	1150-50DEC 1150-1 7/8DEC 1150-1 15/16DEC	90.000	20.00	62.73	24.64	69.90	1.00	35000	23200	3400	1.19	
55 2 2 1/8 2 3/16	1055-55DECG 1055-2DECG 1055-2 1/8DECG 1055-2 3/16DECG	1155-55DEC 1155-2DEC 1155-2 1/8DEC 1155-2 3/16DEC	100.000	21.00	71.42	27.84	76.20	1.50	43500	29200	3100	1.40	
60 2 1/4 2 3/8 2 7/16 2 1/2	1060-60DECG 1060-2 1/4DECG 1060-2 3/8DECG 1060-2 7/16DECG 1060-2 1/2DECG	1160-60DEC 1160-2 1/4DEC 1160-2 3/8DEC 1160-2 7/16DEC 1160-2 1/2DEC	110.000	22.00	77.84	31.04	84.20	1.50	48000	33000	2800	1.72	
65 70	1065-65DECG 1070-70DECG	1165-65DEC 1170-70DEC	120.000 125.000	23.00 24.00	85.74 85.74	34.14 34.14	92.00 97.00	1.50 1.50	57500 61000	40000 45000	2600 2450	2.21 2.56	
70 2 1/2 2 5/8 2 11/16	1070-70DECG 1070-2 1/2DECG 1070-2 5/8DECG 1070-2 11/16DECG	1170-70DEC 1170-2 1/2DEC 1170-2 5/8DEC 1170-2 11/16DEC											
65 70 75	1075-65DECG 1075-70DECG 1075-75DECG	1175-65DEC 1175-70DEC 1175-75DEC	130.000	25.00	92.14	37.34	102.00	1.50	66000	49500	2300	2.94	
75 2 11/16 2 3/4 2 7/8 2 9/16	1075-75DECG 1075-2 11/16DECG 1075-2 3/4DECG 1075-2 7/8DECG 1075-2 9/16DECG	1175-75DEC 1175-2 11/16DEC 1175-2 3/4DEC 1175-2 7/8DEC 1175-2 9/16DEC											

Please check availability

Self-Lube bearing inserts

1200G and 1300 Series

1200G

With spherical outside diameter and integral set screw lock

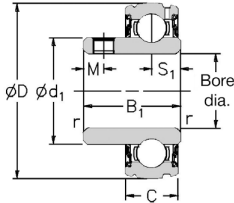

1300

With parallel outside diameter and integral set screw lock

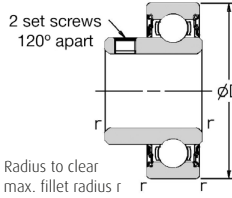

Shaft diameter mm inches	RHP designation		Dimensions (mm)							ISO Load ratings		Rec. max. speed rev/min	Mass (approx.) kg
	1200G Series	1300 Series	D	C	B1	s1	d1	M	r	dynamic Cr newtons	static Cor newtons		
20	1220-20G	1320-20	47.000	14.00	25.80	7.53	28.30	5.00	1.00	12800	6650	6700	0.10
¾	1220-¾G	1320-¾											
25	1225-25G	1325-25	52.000	15.00	27.30	7.53	34.00	5.00	1.00	14000	7880	6250	0.13
1	1225-1G	1325-1											
30	1230-30G	1330-30	62.000	16.00	31.20	9.03	40.30	5.00	1.00	19500	11300	5300	0.32
1¼	1230-1¼G	1330-1¼											
35	1235-35G	1335-35	72.000	17.00	34.90	9.53	46.90	6.50	1.00	25700	15300	4500	0.43
1½	1235-1½G	1335-1½											
40	1240-40G	1340-40	80.000	18.00	41.20	11.03	52.40	8.00	1.00	32500	19900	4000	0.54
1½	1240-1½G	1340-1½											
45	1245-45G	1345-45	85.000	19.00	41.20	11.04	57.40	8.00	1.00	32500	20500	3700	0.61
1¾	1245-1¾G	1345-1¾											
50	1250-50G	1350-50	90.000	20.00	43.50	11.04	62.40	10.00	1.00	35000	23200	3400	0.76

Please check availability

Self-Lube bearing inserts

1200EC and 1200ECG Series

1300EC Series

1200EC

With spherical outside diameter, non-re-greaseable outer ring and eccentric collar lock

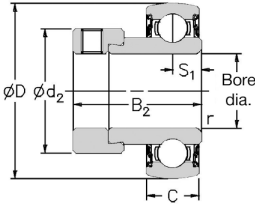

1200ECG

With spherical outside diameter, re-greaseable outer ring and eccentric collar lock

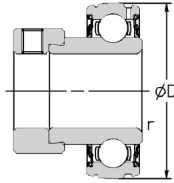

1300EC

With parallel outside diameter and eccentric collar lock

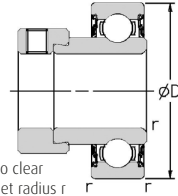

Radius to clear max. fillet radius r

Shaft diameter mm inches	RHP designation			Dimensions (mm)						ISO Load ratings		Rec. max. speed rev/min	Mass (approx.) kg
	1200EC Series	1200ECG Series	1300EC Series	D	C	B2	s1	d2	r	dynamic Cr newtons	static Cor newtons		
12	1217-12EC	1217-12ECG	1317-12EC	40.000	12.00	28.63	6.53	28.60	0.60	9550	4800	7000	0.15
15	1217-15EC	1217-15ECG	1317-15EC										
16	1217-16EC	1217-16ECG	1317-16EC										
17	1217-17EC	1217-17ECG	1317-17EC										
½	1217-½EC	1217-½ECG	1317-½EC										
⅝	1217-⅝EC	1217-⅝ECG	1317-⅝EC										
20	1220-20EC	1220-20ECG	1320-20EC	47.000	14.00	31.03	7.53	33.30	1.00	12800	6650	6700	0.16
¾	1220-¾EC	1220-¾ECG	1320-¾EC										
25	1225-25EC	1225-25ECG	1325-25EC	52.000	15.00	31.03	7.53	38.10	1.00	14000	7880	6250	0.23
⅞	1225-⅞EC	1225-⅞ECG	1325-⅞EC										
1⅙	1225-1⅙EC	1225-1⅙ECG	1325-1⅙EC										
1	1225-1EC	1225-1ECG	1325-1EC										
30	1230-30EC	1230-30ECG	1330-30EC	62.000	16.00	35.73	9.03	44.50	1.00	19500	11300	5300	0.40
1⅛	1230-1⅛EC	1230-1⅛ECG	1330-1⅛EC										
1⅜	1230-1⅜EC	1230-1⅜ECG	1330-1⅜EC										
1¼	1230-1¼EC	1230-1¼ECG	1330-1¼EC										
35	1235-35EC	1235-35ECG	1335-35EC	72.000	17.00	38.93	9.53	55.60	1.00	25700	15300	4500	0.58
1¼	1235-1¼EC	1235-1¼ECG	1335-1¼EC										
1⅝	1235-1⅝EC	1235-1⅝ECG	1335-1⅝EC										
1⅞	1235-1⅞EC	1235-1⅞ECG	1335-1⅞EC										
40	1240-40EC	1240-40ECG	1340-40EC	80.000	18.00	43.73	11.03	60.30	1.00	32500	19900	4000	0.73
1½	1240-1½EC	1240-1½ECG	1340-1½EC										
45	1245-45EC	1245-45ECG	1345-45EC	85.000	19.00	43.73	11.03	63.50	1.00	32500	20500	3700	0.87
1⅝	1245-1⅝EC	1245-1⅝ECG	1345-1⅝EC										
1⅞	1245-1⅞EC	1245-1⅞ECG	1345-1⅞EC										
50	1250-50EC	1250-50ECG	1350-50EC	90.000	20.00	43.73	11.04	69.90	1.00	35000	23200	3400	0.98
1⅞	1250-1⅞EC	1250-1⅞ECG	1350-1⅞EC										
1⅞	1250-1⅞EC	1250-1⅞ECG	1350-1⅞EC										
2	1250-2EC	1250-2ECG	1350-2EC										

Please check availability

Self-Lube bearing inserts complete with snap ring 1100CG Series

1100CG

With parallel outside diameter and integral set screw lock

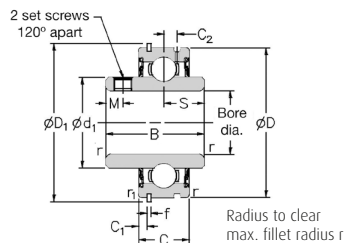

Shaft diameter		RHP designation 1100CG Series	Dimensions (mm)													ISO Load ratings		Rec. max. speed rev/min	Mass (approx.) kg
mm	inches		D	D1	C	C1	C2	B	s	d1	f	M	r	r1	dynamic Cr newtons	static Cor newtons			
20		1120-20CG	47.000	52.68	15.88	2.39	4.17	31.00	12.73	28.30	1.12	5.00	1.00	0.50	12800	6650	6700	0.23	
	¾	1120-¾CG																	
25		1125-25CG	52.000	57.81	19.05	2.39	4.39	34.10	14.33	34.00	1.12	5.00	1.00	0.50	14000	7880	6250	0.31	
	7/8	1125-7/8CG																	
	15/16	1125-15/16CG																	
	1	1125-1CG																	
30		1130-30CG	62.000	67.69	22.22	3.18	5.10	38.10	15.93	40.30	1.70	5.00	1.00	0.50	19500	11300	5300	0.42	
	1 1/8	1130-1 1/8CG																	
	1 1/16	1130-1 1/16CG																	
35		1135-35CG	72.000	78.51	23.81	3.18	5.61	42.90	17.53	46.90	1.70	6.50	1.00	1.00	25700	15300	4500	0.61	
	1 1/4	1135-1 1/4CG																	
	1 3/8	1135-1 3/8CG																	
	1 7/8	1135-1 7/8CG																	
40		1140-40CG	80.000	86.51	27.78	3.18	6.22	49.20	19.03	52.40	1.70	8.00	1.00	1.00	32500	19900	4000	0.91	
	1 1/2	1140-1 1/2CG																	
45		1145-45CG	85.000	91.51	27.78	3.18	6.52	49.20	19.04	57.40	1.70	8.00	1.00	1.00	32500	20500	3700	1.05	
	1 5/8	1145-1 5/8CG																	
	1 11/16	1145-1 11/16CG																	
	1 3/4	1145-1 3/4CG																	
	1 7/8	1150-1 7/8CG	90.000	96.49	28.58	3.18	6.72	51.59	19.10	62.40	2.46	10.00	1.00	1.00	35000	23200	3400	1.10	
	1 15/16	1150-1 15/16CG																	
55		1155-55CG	100.00	106.50	30.16	3.18	7.43	55.60	22.20	68.90	2.46	10.00	1.00	1.00	43500	29200	3100	1.50	
	2	1155-2CG																	
	2 3/16	1155-2 3/16CG																	

Please check availability

Self-Lube bearing inserts with adapter sleeves

1000-KG and 1100-K Series

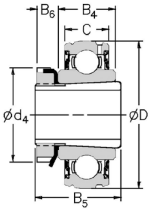

1000-KG

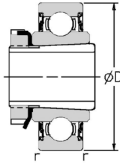

1100-K

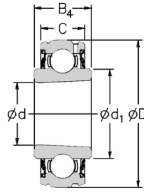

1000KG

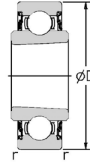

1100K

Bore taper 1:12
on diameter

Shaft diameter		RHP designation		Sleeve nut & lockwasher assembly only	Basic insert without sleeve, nut & lockwasher		Dimensions (mm)		
mm	inches	1000-KG Series	1100-K Series		1000KG	1100K	D	C	B4
20		1025-20KG	1125-20K	H305	1025KG	1125K	52.000	15.00	19.00
	3/4	1025-3/4KG	1125-3/4K	HE305-3/4					
25		1030-25KG	1130-25K	H306	1030KG	1130K	62.000	16.00	20.00
	15/16	1030-15/16KG	1130-15/16K	HE306-15/16					
	1	1030-1KG	1130-1K	HE306-1					
30		1035-30KG	1135-30K	H307	1035KG	1135K	72.000	17.00	21.00
	1 1/8	1035-1 1/8KG	1135-1 1/8K	HE307-1 1/8					
	1 1/16	1035-1 1/16KG	1135-1 1/16K	HE307-1 1/16					
35		1040-35KG	1140-35K	H308	1040KG	1140K	80.000	18.00	22.00
	1 1/4	1040-1 1/4KG	1140-1 1/4K	HE308-1 1/4					
	1 3/8	1040-1 3/8KG	1140-1 3/8K	HE308-1 3/8					
40		1045-40KG	1145-40K	H309	1045KG	1145K	85.000	19.00	23.00
	1 7/16	1045-1 7/16KG	1145-1 7/16K	HE309-1 7/16					
	1 1/2	1045-1 1/2KG	1145-1 1/2K	HE309-1 1/2					
45		1050-45KG	1150-45K	H310	1050KG	1150K	90.000	20.00	24.00
	1 11/16	1050-1 11/16KG	1150-1 11/16K	HE310-1 11/16					
	1 3/4	1050-1 3/4KG	1150-1 3/4K	HE310-1 3/4					
50		1055-50KG	1155-50K	H311	1055KG	1155K	100.000	21.00	25.00
	1 15/16	1055-1 15/16KG	1155-1 15/16K	HE311-1 15/16					
	2	1055-2KG	1155-2K	HE311-2					

Please check availability

Dimensions (mm)						ISO Load ratings		Rec. max. speed	Mass (approx.)
B5	B6	d	d1	d4	r	dynamic Cr newtons	static Cor newtons	rev/min	kg
29.00	8.00	25.000	34.00	38.00	1.00	14000	7880	6250	0.20
31.00	8.00	30.000	40.30	45.00	1.00	19500	11300	5300	0.30
35.00	9.00	35.000	46.90	52.00	1.00	25700	15300	4500	0.42
36.00	10.00	40.000	52.40	58.00	1.00	32500	19900	4000	0.54
39.00	11.00	45.000	57.40	65.00	1.00	32500	20500	3700	0.64
42.00	12.00	50.000	62.40	70.00	1.00	35000	23200	3400	0.75
45.00	12.00	55.000	68.90	75.00	1.50	43500	29200	3100	0.95

Self-Lube triple seal bearing inserts

T1000G Series

T1000G

With spherical outside diameter and integral set screw lock

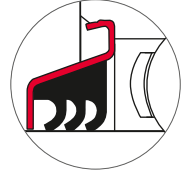
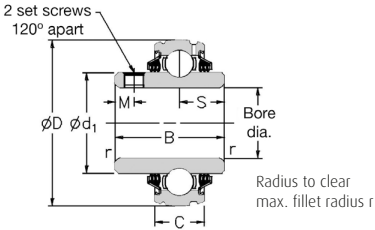

Shaft diameter mm inches	RHP designation	Dimensions (mm)						ISO Load ratings		Rec. max. speed rev/min	Mass (approx.) kg	
		D	C	B	s	d1	M	r	dynamic Cr newtons			static Cor newtons
25	T1025-25G	52.000	15.00	34.10	14.33	34.00	5.00	1.00	14000	7880	1000	0.17
7/8	T1025-7/8G											
15/16	T1025-15/16G											
1	T1025-1G											
25	T1030-25G	62.000	18.00	38.10	15.93	40.30	5.00	1.00	19500	11300	850	0.37
30	T1030-30G											
7/8	T1030-7/8G											
1	T1030-1G											
1 1/8	T1030-1 1/8G											
1 3/16	T1030-1 3/16G											
1 1/4	T1030-1 1/4G											
30	T1035-30G	72.000	19.00	42.90	17.53	46.90	6.50	1.00	25700	15300	750	0.51
35	T1035-35G											
1 3/16	T1035-1 3/16G											
1 1/4	T1035-1 1/4G											
1 3/8	T1035-1 3/8G											
1 7/16	T1035-1 7/16G											
35	T1040-35G	80.000	21.00	49.20	19.03	52.40	8.00	1.00	32500	19900	650	0.64
40	T1040-40G											
1 3/8	T1040-1 3/8G											
1 7/16	T1040-1 7/16G											
1 1/2	T1040-1 1/2G											
40	T1045-40G	85.000	22.00	49.20	19.04	57.40	8.00	1.00	32500	20500	600	0.73
45	T1045-45G											
1 1/2	T1045-1 1/2G											
1 5/8	T1045-1 5/8G											
1 11/16	T1045-1 11/16G											
1 3/4	T1045-1 3/4G											
45	T1050-45G	90.000	23.00	51.60	19.04	62.40	10.00	1.00	35000	23200	550	0.91
50	T1050-50G											
1 11/16	T1050-1 11/16G											
1 3/4	T1050-1 3/4G											
1 7/8	T1050-1 7/8G											
1 15/16	T1050-1 15/16G											
2	T1050-2G											
50	T1055-50G	100.000	25.00	55.60	22.24	68.90	10.00	1.50	43500	29200	500	1.12
55	T1055-55G											
1 7/8	T1055-1 7/8G											
1 15/16	T1055-1 15/16G											
2	T1055-2G											
2 1/8	T1055-2 1/8G											
2 3/16	T1055-2 3/16G											

Please check availability

Shaft diameter		RHP designation	Dimensions (mm)							ISO Load ratings		Rec. max. speed rev/min	Mass (approx.) kg
mm	inches		D	C	B	s	d1	M	r	dynamic Cr newtons	static Cor newtons		
55		T1060-55G	110.000	25.00	65.10	25.44	76.00	10.00	1.50	48000	33000	450	1.50
60		T1060-60G											
	2 ³ / ₁₆	T1060-2³/₁₆G											
	2 ¹ / ₄	T1060-2¹/₄G											
	2 ³ / ₈	T1060-2³/₈G											
	2 ⁷ / ₁₆	T1060-2⁷/₁₆G											
60		T1070-60G	125.000	28.00	74.60	30.24	89.00	12.00	1.50	61000	45000	400	2.30
65		T1070-65G											
70		T1070-70G											
	2 ⁷ / ₁₆	T1070-2⁷/₁₆G											
	2 ¹ / ₂	T1070-2¹/₂G											
	2 ⁵ / ₈	T1070-2⁵/₈G											
	2 ¹¹ / ₁₆	T1070-2¹¹/₁₆G											
75		T1080-75G	140.000	30.00	82.60	33.34	100.00	12.00	2.00	71500	54500	345	3.27
80		T1080-80G											
	2 ¹⁵ / ₁₆	T1080-2¹⁵/₁₆G											
	3	T1080-3G											

Please check availability

Self-Lube triple seal bearing inserts

T1000DECG Series

T1000DECG

With spherical outside diameter and eccentric collar lock

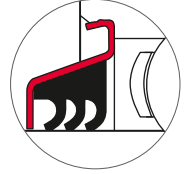
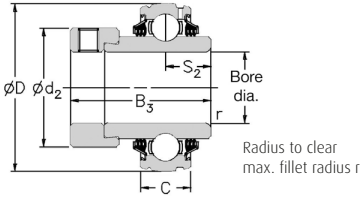

Shaft diameter		RHP designation	Dimensions (mm)					ISO Load ratings			Rec. max. speed rev/min	Mass (approx.) kg
mm	inches		D	C	B3	s2	d2	r	dynamic Cr newtons	static Cor newtons		
25		T1025-25DECG	52.000	15.00	44.43	17.53	38.10	1.00	14000	7880	1000	0.26
	7/8	T1025-7/8DECG										
	15/16	T1025-15/16DECG										
	1	T1025-1DECG										
30		T1030-30DECG	62.000	18.00	48.43	18.33	44.50	1.00	19500	11300	850	0.53
	1 1/8	T1030-1 1/8DECG										
	1 1/16	T1030-1 1/16DECG										
	1 1/4	T1030-1 1/4DECG										
35		T1035-35DECG	72.000	19.00	51.13	18.83	55.60	1.00	25700	15300	750	0.70
	1 1/4	T1035-1 1/4DECG										
	1 3/8	T1035-1 3/8DECG										
	1 7/16	T1035-1 7/16DECG										
40		T1040-40DECG	80.000	21.00	56.33	21.43	60.30	1.00	32500	19900	650	0.82
	1 1/2	T1040-1 1/2DECG										
45		T1045-45DECG	85.000	22.00	56.33	21.43	63.50	1.00	32500	20500	600	1.08
	1 3/8	T1045-1 3/8DECG										
	1 11/16	T1045-1 11/16DECG										
	1 3/4	T1045-1 3/4DECG										
50		T1050-50DECG	90.000	23.00	62.73	24.64	69.90	1.00	35000	23200	550	1.19
	1 7/8	T1050-1 7/8DECG										
	1 15/16	T1050-1 15/16DECG										
55		T1055-55DECG	100.000	25.00	71.42	27.84	76.20	1.50	43500	29200	500	1.40
	2	T1055-2DECG										
	2 1/8	T1055-2 1/8DECG										
	2 1/16	T1055-2 1/16DECG										
60		T1060-60DECG	110.000	25.00	77.84	31.04	84.20	1.50	48000	33000	450	1.81
	2 1/4	T1060-2 1/4DECG										
	2 7/16	T1060-2 7/16DECG										
65		T1070-65DECG	125.000	28.00	85.74	34.14	97.00	1.50	61000	45000	400	2.49
70		T1070-70DECG										

Please check availability

Self-Lube bearing inserts with flinger seals

1000GFS Series

1000GFS

With spherical outside diameter and integral set screw lock

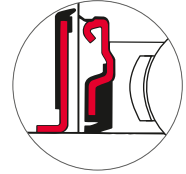
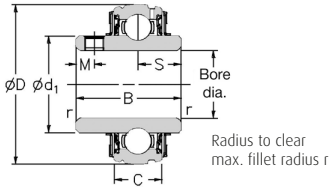

Shaft diameter		RHP designation	Dimensions (mm)							ISO Load ratings		Rec. max. speed rev/min	Mass (approx.) kg	
mm	inches		D	C	B	s	d1	M	r	dynamic Cr newtons	static Cor newtons			
25		1025-25GFS	52.000	15.00	34.10	14.33	34.00	5.00	1.00	14000	7880	6250	0.17	
		1025-7/8GFS												
		1025-15/16GFS												
		1025-1GFS												
25		1030-25GFS	62.000	16.00	38.10	15.93	40.30	5.00	1.00	19500	11300	5300	0.37	
30		1030-30GFS												
		1030-7/8GFS												
		1030-1GFS												
		1030-1 1/8GFS												
30		1035-30GFS	72.000	17.00	42.90	17.53	46.90	6.50	1.00	25700	15300	4500	0.51	
	35													1035-35GFS
														1035-1 1/16GFS
														1035-1 1/4GFS
														1035-1 3/16GFS
35		1035-1 1/2GFS	80.000	18.00	49.20	19.03	52.40	8.00	1.00	32500	19900	4000	0.64	
	40													1040-35GFS
														1040-40GFS
														1040-1 1/8GFS
														1040-1 1/16GFS
40		1045-40GFS	85.000	19.00	49.20	19.04	57.40	8.00	1.00	32500	20500	3700	0.73	
	45													1045-45GFS
														1045-1 1/2GFS
														1045-1 5/8GFS
														1045-1 7/8GFS
45		1050-45GFS	90.000	20.00	51.60	19.04	62.40	10.00	1.00	35000	23200	3400	0.91	
	50													1050-50GFS
														1050-1 1/16GFS
														1050-1 3/4GFS
														1050-1 7/8GFS
50		1050-1 5/8GFS	100.000	21.00	55.60	22.24	68.90	10.00	1.50	43500	29200	3100	1.12	
	55													1055-50GFS
														1055-55GFS
														1055-1 1/8GFS
														1055-1 1/4GFS
55		1060-55GFS	110.000	22.00	65.10	25.44	76.00	10.00	1.50	48000	33000	2800	1.47	
	60													1060-60GFS
														1060-2 3/16GFS
														1060-2 1/4GFS
														1060-2 3/8GFS
		1060-2 7/16GFS												

Please check availability

Self-Lube bearing inserts with flinger seals

1000DECGFS Series

1000DECGFS

With spherical outside diameter and eccentric collar lock

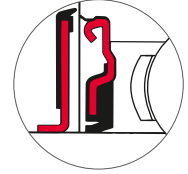
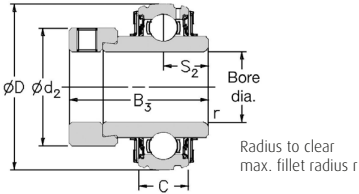

Shaft diameter		RHP designation	Dimensions (mm)						ISO Load ratings		Rec. max. speed rev/min	Mass (approx.) kg
mm	inches		D	C	B3	s2	d2	r	dynamic Cr newtons	static Cor newtons		
25		1025-25DECGFS	52.000	15.00	44.43	17.53	38.10	1.00	14000	7880	6250	0.26
	7/8	1025-7/8DECGFS										
	15/16	1025-15/16DECGFS										
	1	1025-1DECGFS										
30		1030-30DECGFS	62.000	16.00	48.43	18.33	44.50	1.00	19500	11300	5300	0.53
	1	1030-1DECGFS										
	13/16	1030-13/16DECGFS										
	1/4	1030-1/4DECGFS										
35		1035-35DECGFS	72.000	17.00	51.13	18.83	55.60	1.00	25700	15300	4500	0.70
	1/4	1035-1/4DECGFS										
	15/16	1035-15/16DECGFS										
	13/8	1035-13/8DECGFS										
	17/16	1035-17/16DECGFS										
40		1040-40DECGFS	80.000	18.00	56.33	21.43	60.30	1.00	32500	19900	4000	0.82
	1 1/2	1040-1 1/2DECGFS										
45		1045-45DECGFS	85.000	19.00	56.33	21.43	63.50	1.00	32500	20500	3700	1.08
	1 5/8	1045-1 5/8DECGFS										
	1 11/16	1045-1 11/16DECGFS										
	1 3/4	1045-1 3/4DECGFS										
50		1050-50DECGFS	90.000	20.00	62.73	24.64	69.90	1.00	35000	23200	3400	1.19
	1 7/8	1050-1 7/8DECGFS										
	1 15/16	1050-1 15/16DECGFS										
55		1055-55DECGFS	100.000	21.00	71.42	27.84	76.20	1.50	43500	29200	3100	1.40
	2	1055-2DECGFS										
	2 1/8	1055-2 1/8DECGFS										
	2 1/4	1055-2 1/4DECGFS										
60		1060-60DECGFS	110.000	22.00	77.84	31.04	84.20	1.50	48000	33000	2800	1.72
	2 1/4	1060-2 1/4DECGFS										
	2 3/8	1060-2 3/8DECGFS										
	2 7/16	1060-2 7/16DECGFS										

Please check availability

Self-Lube protector

The Protector Range

RHP designation	Dimensions (mm)			Basic bearing insert
	Dp	A	A1	
20P	37.0	23.0	30.0	1020
25P	42.5	23.0	30.5	1025
30P=2	50.5	36.0	44.0	1030
35P=2	60.5	38.5	47.0	1035
40P=1	67.5	42.0	51.0	1040
45P	72.0	30.0	39.5	1045
50P=1	76.0	46.0	56.0	1050
55P	85.0	37.5	48.0	1055
60P	94.0	40.5	51.5	1060

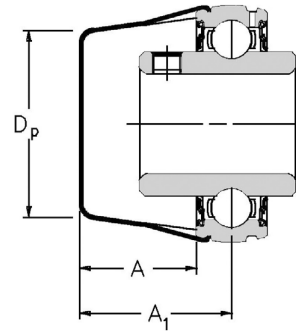

The following table shows the range of units which can be fitted with a protector and indicates the right protector to select.

Bore size	Self-Lube unit												
	NP	SFT	SNP	LFTEC	FC	ST	BT	SLFEP	SLFTP	MFC	SCHB	NP-K	MP
	NP-A	SFT-A	SNP-A	LFTEC-A	FC-A	ST-A	BT-A	SLFEP-A	SLFTP-A		SCH	MP-K	MSF
	NP-EC	SFT-EC	SNP-EC	LFTEC-EC	FC-EC	ST-EC	BT-EC	SLFEP-EC	SLFTP-EC			MSF-K	MSFT
	NP-DEC	SFT-DEC	SNP-DEC	LFTEC-DEC	FC-DEC	ST-DEC		SLFEP-DEC	SLFTP-DEC			MSFT-K	MST
	SL	SLC	CNP	SLFLP								MST-K	MSC
	SL-A	SLC-A	CNP-A	SLFLP-A									
	SL-EC	SLC-EC	CNP-EC	SLFLP-EC									
	SL-DEC	SLC-DEC	CNP-DEC	SLFLP-DEC									
	SF												
	SF-A												
	SF-EC												
	SF-DEC												
20, 3/4	20P	20P	20P	20P	20P	20P	-	20P	-	-	20P	25P	-
25, 7/8, 15/16, 1	25P	25P	25P	25P	25P	25P	25P	25P	25P	30P=2	30P=2	30P=2	30P=2
30, 1 1/8	30P=2	30P=2	30P=2	30P=2	30P=2	30P=2	-	30P=2	30P=2	35P=2	30P=2	35P=2	35P=2
1 3/16	30P=2	30P=2	30P=2	30P=2	30P=2	30P=2	-	30P=2	30P=2	35P=2	35P=2	35P=2	35P=2
1 1/4	35P=2	35P=2	35P=2	30P=2	35P=2	35P=2	35P=2	30P=2	30P=2	35P=2	35P=2	40P=1	35P=2
35, 1 3/8	35P=2	35P=2	35P=2	35P=2	35P=2	35P=2	35P=2	35P=2	35P=2	40P=1	35P=2	40P=1	40P=1
1 7/16	35P=2	35P=2	35P=2	35P=2	35P=2	35P=2	35P=2	35P=2	35P=2	40P=1	40P=1	45P	40P=1
40, 1 1/2	40P=1	40P=1	40P=1	-	40P=1	40P=1	-	40P=1*	-	40P=1	40P=1	45P	45P
45, 1 5/8	45P	45P	45P	-	45P	45P	-	45P*	-	50P=1	50P=1	50P=1	50P=1
1 11/16, 1 3/4	45P	45P	45P	-	45P	45P	-	45P*	-	50P=1	50P=1	50P=1	50P=1
50, 1 7/8, 1 5/8	50P=1	50P=1	-	-	50P=1	50P=1	-	50P=1*	-	55P	50P=1	55P	55P
2	55P	55P	-	-	55P	55P	-	55P*	-	55P	50P=1	55P	55P
55, 2 1/8, 2 3/16	55P	55P	-	-	55P	55P	-	55P*	-	60P	60P	-	60P
2 1/4	60P	60P	-	-	60P	60P	-	60P*	-	60P	60P	-	60P
60, 2 3/8, 2 7/16	60P	60P	-	-	60P	60P	-	60P*	-	-	60P	-	-

* Please check availability of units (protectors are available, but special SLFEP flanges may not be).

Note 1: The appropriate protector is determined by the basic bearing insert group.

Note 2: When a pressing from the series SLFL, SLFE or SLFT is fitted with a protector, the unit reference includes the letter "P", e.g. SLFEP-25EC.

Additional products

LF series, LFG series

A range of three bolt spheroidal graphite iron housed units, available in bore sizes 25mm to 35mm and 1" to 1⁷/₁₆".

LF series units are not re-greaseable.

LFG series units use an M5 grease nipple.

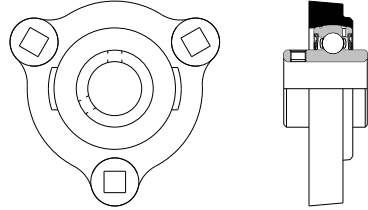

LF series

AR-A series, AR-EC series

The AR series is the bearing and rubber cartridge used in the LPBR unit (Pages 76 and 77).

Available as a series for users who have their own housing.

Bore sizes 12mm to 30mm and 1/2" to 1 1/4".

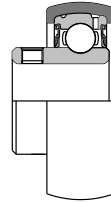

AR-A series

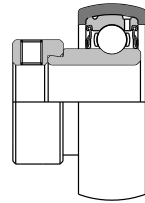

AR-EC series

SRM-EC series

Rubber housed units fitted with the 1120 or 1125 type inserts. Available in bore sizes 20mm, 3/4", 25mm, 7/8" and 1" with eccentric collar or set screw lock.

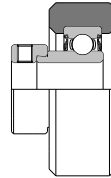

SRM-EC series

SRC-EC series

Rubber housed units suitable for the air conditioning market, two housings each with an outside diameter of 64,5mm and in bore sizes 20mm to 25mm and 3/4" to 1" are available.

Special SRC types

Bore sizes 20mm and 3/4".

Offered with eccentric collar lock.

(SRC11004 and SRC11005 respectively.)

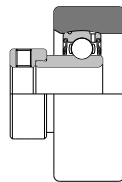

SRC-EC series

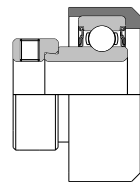

Special SRC series

2300-EC extra light series

The 2300-EC series is an extra light bearing, based on the 6000 series configuration, and is available in bore sizes 20mm to 30mm and $\frac{3}{4}$ " to $1\frac{3}{16}$ ".

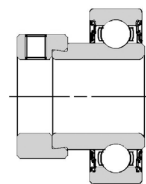

2300-EC
extra light series

1600-G series, 1600-HG series

A range of spherical outside diameter deep groove wide inner ring ball bearings with either round or hexagonal bores.

These are re-greaseable and available in round bore sizes 20mm to 75mm and $\frac{3}{4}$ " to $2\frac{15}{16}$ " and hexagonal bore sizes $\frac{7}{8}$ " AF to $1\frac{1}{2}$ " AF and 22mm AF to 38mm AF. Round bore diameters are an interference fit on the shaft.

The standard Self-Lube cage and seals are fitted.



1600-G series

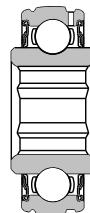

1600-HG series

1700 series, 1700-H series

As 1600-G, 1600-HG but with parallel outside diameters, although this range is not re-greaseable.

Again, round bore diameters are an interference fit on the shaft.

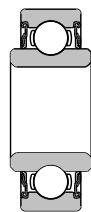

1700 series

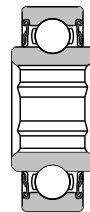

1700-H series



Silver-Lube Bearing Units

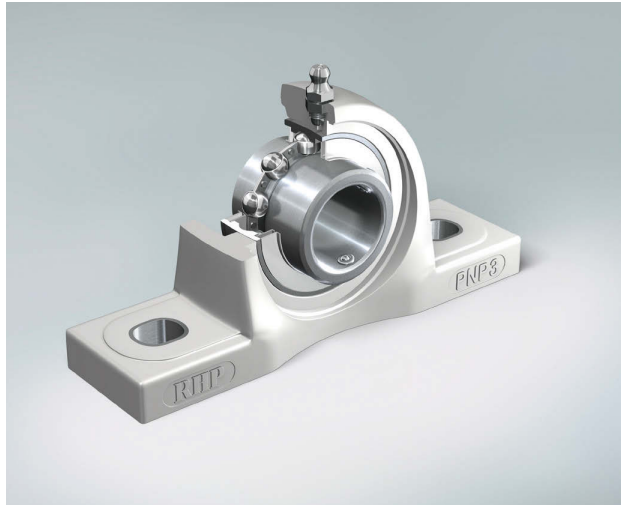

Silver-Lube unit references

Insert Type

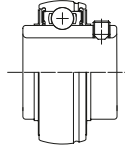

Housing Type



Page	100
------	-----

102	PNP
-----	-----



104	PSF
-----	-----



106	PSFT
-----	------



108	PST
-----	-----

Silver-Lube insert references

J

Reverse outer
(Grease groove same side as set screw)

10

OD profile
10: Spherical outside diameter

25

Basic group

-

25

Bore size
2 Digits: Millimetre sizes
Single Digit + fractions:
Inch sizes

Greaseable
G: All supplied as re-greaseable

G

Corrosion Resistant
Rings, cage, balls and flinger are corrosion resisting steels

CR

Silver-Lube product range

Introduction

The Silver-Lube series is a range of corrosion resistant bearing units specifically for use in industries where frequent thorough washdowns are necessary, optimum hygiene standards are required and good chemical resistance is important over a wide temperature range.

The units are available in pillow block, two-bolt flange, four-bolt flange and take-up unit configurations and are capable of accommodating initial misalignment from mounting errors. In operation the units have proven reliability in the most hostile applications. Relubrication is possible for long trouble-free life, minimising maintenance, maximising productivity and helping maintain hygiene standards.

Silver-Lube housings are made from PBT thermoplastic resin which, in addition to being non-corrodible, is resistant to detergents and a wide range of chemicals. The housings are paint and coating free which prevents chipping or flaking and have smooth surfaces to assist thorough washdowns.

Silver-Lube bearing inserts are made from stainless steel, are provided with effective, efficient sealing arrangements and are charged with an aluminium complex, high temperature approved food grade grease as standard.

For Silver-Lube bearings the radial internal clearance (RIC) is C3.

Housing strength

Housing load carrying capacity varies depending on the application loading regime, which may be intermittent, continuous or cyclical. Maximum housing loads are given in tables 1, 2, 3 and 4. These loads must not be exceeded without prior consultation with NSK.

Published housing maximum load capacities do not allow for any reduction in housing strength caused by exposure of the housing to chemicals, water, steam, heat, ultraviolet light or any combination of these factors. If any of these factors are present in the application the designer or end-user must establish the effect of these exposures and reduce the published maximum housing load accordingly.

To maximise load carrying capacity it is recommended that washers are used with the fixing bolts. Tables 1, 2 and 3 also detail maximum fixing bolt tightening torques.

Static electricity generation

Static electricity may be generated by Silver-Lube bearing units under certain application conditions.

Silver-Lube bearings are therefore not recommended for use in explosive or flammable environments. If Silver-Lube bearing units are used in flammable or explosive applications the bearing insert must be earthed.

Housing strength

PNP Series

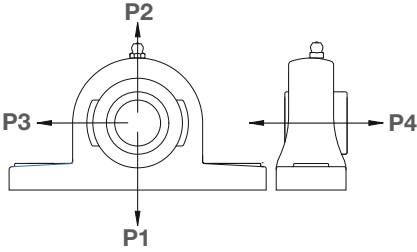

Table 1 PNP Silver-Lube pillow block - housing load capacity

RHP designation	Maximum housing load (N) at 20°C												Max. fixing bolt torque (Nm)
	P1			P2			P3			P4			
	Intermittent loading	Continuous loading	Cyclical loading	Intermittent loading	Continuous loading	Cyclical loading	Intermittent loading	Continuous loading	Cyclical loading	Intermittent loading	Continuous loading	Cyclical loading	
PNP20CR	3500	1700	800	2800	1400	800	2600	1300	700	1300	700	400	18
PNP3/4CR	3500	1700	800	2800	1400	800	2600	1300	700	1300	700	400	18
PNP25CR	4000	2000	1000	3100	1500	800	2600	1300	700	1700	900	500	25
PNP1CR	4000	2000	1000	3100	1500	800	2600	1300	700	1700	900	500	25
PNP30CR	5000	2500	1200	3500	1800	1000	4000	2000	1100	2600	1300	700	30
PNP13/16CR	5000	2500	1200	3500	1800	1000	4000	2000	1100	2600	1300	700	30
PNP11/8CR	5000	2500	1200	3500	1800	1000	4000	2000	1100	2600	1300	700	30
PNP35CR	6000	3000	1500	4300	2100	1200	4100	2100	1100	3200	1600	900	35
PNP11/4CR	6000	3000	1500	4300	2100	1200	4100	2100	1100	3200	1600	900	35
PNP17/16CR	6000	3000	1500	4300	2100	1200	4100	2100	1100	3200	1600	900	35
PNP40CR	10700	5300	2900	8000	4000	2200	6800	3400	1900	5200	2600	1400	40
PNP11/2CR	10700	5300	2900	8000	4000	2200	6800	3400	1900	5200	2600	1400	40

Table 2 PSF Silver-Lube four-bolt flange - housing load capacity

RHP designation	Maximum housing load (N) at 20°C						Max. fixing bolt torque (Nm)
	F1			F2			
	Intermittent loading	Continuous loading	Cyclical loading	Intermittent loading	Continuous loading	Cyclical loading	
PSF20CR	3100	1600	900	1300	700	400	18
PSF3/4CR	3100	1600	900	1300	700	400	18
PSF25CR	3500	1700	1000	1300	700	400	25
PSF1CR	3500	1700	1000	1300	700	400	25
PSF30CR	4600	2300	1300	2200	1100	600	30
PSF13/16CR	4600	2300	1300	2200	1100	600	30
PSF11/8CR	4600	2300	1300	2200	1100	600	30
PSF35CR	6200	3100	1700	2600	1300	700	35
PSF11/4CR	6200	3100	1700	2600	1300	700	35
PSF17/16CR	6200	3100	1700	2600	1300	700	35
PSF40CR	6200	3100	1700	4000	2000	1100	40
PSF11/2CR	6200	3100	1700	4000	2000	1100	40

PSF Series

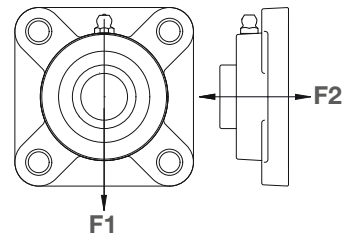

PSFT Series

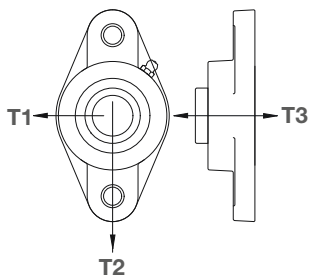

Table 3 PSFT Silver-Lube two-bolt flange - housing load capacity

RHP designation	Maximum housing load (N) at 20°C									Max. fixing bolt torque (Nm)
	T1			T2			T3			
	Intermittent loading	Continuous loading	Cyclical loading	Intermittent loading	Continuous loading	Cyclical loading	Intermittent loading	Continuous loading	Cyclical loading	
PSFT20CR	4400	2200	1200	1900	900	500	1300	700	400	18
PSFT¾CR	4400	2200	1200	1900	900	500	1300	700	400	18
PSFT25CR	4400	2200	1200	3000	1500	800	1400	700	400	25
PSFT1CR	4400	2200	1200	3000	1500	800	1400	700	400	25
PSFT30CR	5900	2900	1600	3300	1600	900	2000	1000	500	30
PSFT1¾CR	5900	2900	1600	3300	1600	900	2000	1000	500	30
PSFT1¼RCR	5900	2900	1600	3300	1600	900	2000	1000	500	30
PSFT35CR	6400	3200	1700	3900	2000	1100	2800	1400	800	35
PSFT1¼CR	6400	3200	1700	3900	2000	1100	2800	1400	800	35
PSFT1¾CR	6400	3200	1700	3900	2000	1100	2800	1400	800	35
PSFT40CR	9000	4500	2500	3900	2000	1100	3300	1600	900	40
PSFT1½CR	9000	4500	2500	3900	2000	1100	3300	1600	900	40

Table 4 PST Silver-Lube take-up - housing load capacity

RHP designation	Maximum housing load (N) at 20°C		
	U Intermittent loading	U Continuous loading	U Cyclical loading
PST20CR	5700	2800	1600
PST¾CR	5700	2800	1600
PST25CR	5400	2700	1500
PST1CR	5400	2700	1500
PST30CR	8100	4000	2300
PST1¾CR	8100	4000	2300
PST1¼RCR	8100	4000	2300
PST35CR	7800	3900	2200
PST1¼CR	7800	3900	2200
PST1¾CR	7800	3900	2200
PST40CR	8100	4000	2300
PST1½CR	8100	4000	2300

PST Series

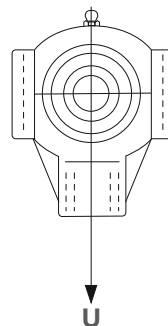

Silver-Lube bearing inserts

Silver-Lube bearing inserts have martensitic stainless steel rings and balls, and austenitic stainless steel ball cage, flingers and set screws, in addition to durable and heat-resistant silicone rubber seals

The grease in this product is an aluminium complex food grade grease, classified to NSF grade H1. In the event of relubricating being necessary, this type of grease is the first choice replacement.

If an aluminium complex food grade grease is not available, it is essential that any alternative grease is NSF H1 approved and ideally chemically compatible with the original grease. If chemical compatibility cannot be assured, then it is recommended that the original grease is completely flushed out of the system before relubrication. NSK should be consulted where necessary.

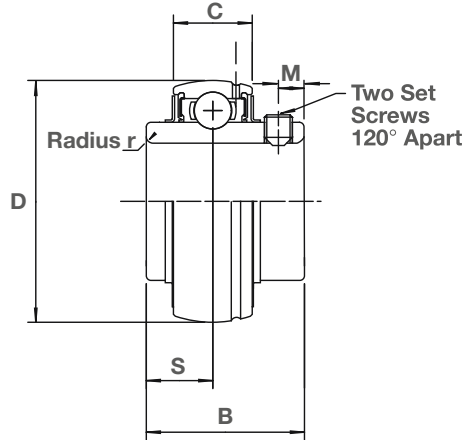

Table 5 Insert designations, dimensions and weights

Units mm

RHP designation	Bore dia	D	C	B	S	r	M	C _i (N)	C _{or} (N)	Weight (Kg)
J1020-20GCR	20	47	17	31.0	12.7	0.5	5.0	9910	5350	0.16
J1020-3/4GCR	3/4"	47	17	31.0	12.7	0.5	5.0	9910	5350	0.16
J1025-25GCR	25	52	17	34.1	14.3	0.5	5.0	10820	6300	0.20
J1025-1GCR	1"	52	17	34.1	14.3	0.5	5.0	10820	6300	0.20
J1030-30GCR	30	62	19	38.1	15.9	0.5	5.0	15000	9050	0.32
J1030-13/16GCR	13/16"	62	19	38.1	15.9	0.5	5.0	15000	9050	0.32
J1030-11/4GCR	11/4"	62	19	38.1	15.9	0.5	5.0	15000	9050	0.32
J1035-35GCR	35	72	20	42.9	17.5	1.0	6.5	19820	12300	0.48
J1035-11/4GCR	11/4"	72	20	42.9	17.5	1.0	6.5	19820	12300	0.48
J1035-17/16GCR	17/16"	72	20	42.9	17.5	1.0	6.5	19820	12300	0.48
J1040-40GCR	40	80	21	49.2	19.0	1.0	8.0	22540	14300	0.64
J1040-11/2GCR	11/2"	80	21	49.2	19.0	1.0	8.0	22540	14300	0.64

Shaft tolerances and permissible speeds

Bearing insert permissible speed is dependent on shaft tolerance. For higher speed applications an ISO h7 shaft tolerance is recommended. An ISO h9 shaft tolerance may be used for low speed applications. For more information see table 6.

Table 6 Tolerances and Speeds

Basic bearing insert	Bearing limiting speed (RPM)	ISO h7 Shaft tolerance high (0.001 mm Units)	ISO h7 Shaft tolerance low (0.001 mm Units)	Bearing limiting speed (RPM)	ISO h9 Shaft tolerance high (0.001 mm Units)	ISO h9 Shaft tolerance low (0.001 mm Units)
J1020	2900	0	-21	1490	0	-52
J1025	2600	0	-21	1300	0	-52
J1030	2180	0	-21	1090	0	-52
J1035	1870	0	-25	940	0	-62
J1040	1650	0	-25	830	0	-62

Materials and tightening torques

Materials

	Parts	Materials
Bearing	Bearing Rings	Martensitic stainless steel (equivalent to SUS440C)
	Ball	Martensitic stainless steel (equivalent to SUS440C)
	Flinger	Austenitic stainless steel (equivalent to SUS302)
	Rubber Seal	Silicone Rubber
	Set Screw	Austenitic stainless steel (equivalent to SUS304)
	Cage	Austenitic stainless steel (equivalent to SUS302)
Bearing housing		Thermo Plastic PBT

Set screw tightening torques

Set screws for Silver-Lube bearing inserts are manufactured from stainless steel and can fracture if overtightened. The limiting set screw torques listed (in Table 7) should not be exceeded.

Table 7 Recommended tightening torques for set screws

Bearing designation	Designation of set screws	Maximum tightening torque (Nm)
J1020-20GCR	M6 X 6.0 LONG	4
J1020-3/4GCR	M6 X 6.0 LONG	4
J1025-25GCR	M6 X 6.0 LONG	4
J1025-1GCR	M6 X 6.0 LONG	4
J1030-30GCR	M6 X 6.0 LONG	4
J1030-13/16GCR	M6 X 6.0 LONG	4
J1030-11/4GCR	M6 X 6.0 LONG	4
J1035-35GCR	M8 X 8.0 LONG	8
J1035-11/4GCR	M8 X 8.0 LONG	8
J1035-17/16GCR	M8 X 8.0 LONG	8
J1040-40GCR	M8 X 8.0 LONG	8
J1040-11/2GCR	M8 X 8.0 LONG	8

Unit dimensions

Table 8: PNP Silver-Lube pillow block - unit dimensions

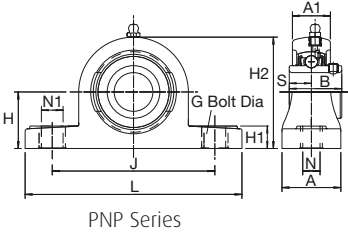

Shaft diameter		RHP designation	Basic bearing insert	Housing group	Dimensions (mm)				
mm	inches				L	H	H1	H2	J
20		PNP20CR	J1020	2	127.2	33.3	14.2	65.9	94.9
	3/4	PNP3/4CR	J1020	2	127.2	33.3	14.2	65.9	94.9
25		PNP25CR	J1025	3	140.2	36.5	14.5	71.9	104.9
	1	PNP1CR	J1025	3	140.2	36.5	14.5	71.9	104.9
30		PNP30CR	J1030	4	162.2	42.9	17.8	83.9	118.9
	1 1/16	PNP1 1/16CR	J1030	4	162.2	42.9	17.8	83.9	118.9
	1 1/4	PNP1 1/4RCR	J1030	4	162.2	42.9	17.8	83.9	118.9
35		PNP35CR	J1035	5	167.2	47.6	18.0	94.9	126.9
	1 1/4	PNP1 1/4CR	J1035	5	167.2	47.6	18.0	94.9	126.9
	1 7/16	PNP1 7/16CR	J1035	5	167.2	47.6	18.0	94.9	126.9
40		PNP40CR	J1040	6	184.2	49.2	19.5	98.9	136.8
	1 1/2	PNP1 1/2CR	J1040	6	184.2	49.2	19.5	98.9	136.8

All dimensions in mm except inch shaft sizes

Dimensions (mm)							Weight kg
N	N1	G	A	A1	B	S	
11.0	14.2	M10	37.8	22.5	31.0	12.7	0.27
11.0	14.2	M10	37.8	22.5	31.0	12.7	0.27
11.0	14.2	M10	37.8	24.5	34.0	14.3	0.39
11.0	14.2	M10	37.8	24.5	34.0	14.3	0.39
14.0	18.2	M12	45.8	27.0	38.1	15.9	0.52
14.0	18.2	M12	45.8	27.0	38.1	15.9	0.52
14.0	18.2	M12	45.8	27.0	38.1	15.9	0.52
14.0	18.2	M12	47.8	32.5	42.9	17.5	0.72
14.0	18.2	M12	47.8	32.5	42.9	17.5	0.72
14.0	18.2	M12	47.8	32.5	42.9	17.5	0.72
14.0	18.2	M12	53.8	36.0	49.2	19.0	0.99
14.0	18.2	M12	53.8	36.0	49.2	19.0	0.99

Unit dimensions

Table 9: PSF Silver-Lube four-bolt flange - unit dimensions

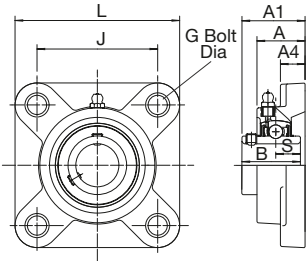

PSF Series

Shaft diameter		RHP designation	Basic bearing insert	Housing group	Dimensions (mm)		
mm	inches				L	J	G
20		PSF20CR	J1020	2	86.5	63.5	M10
	3/4	PSF3/4CR	J1020	2	86.5	63.5	M10
25		PSF25CR	J1025	3	95.0	70.0	M10
	1	PSF1CR	J1025	3	95.0	70.0	M10
30		PSF30CR	J1030	4	107.5	83.0	M10
	1 1/16	PSF1 1/16CR	J1030	4	107.5	83.0	M10
	1 1/4	PSF1 1/4RCR	J1030	4	107.5	83.0	M10
35		PSF35CR	J1035	5	117.5	92.0	M12
	1 1/4	PSF1 1/4CR	J1035	5	117.5	92.0	M12
	1 7/16	PSF1 7/16CR	J1035	5	117.5	92.0	M12
40		PSF40CR	J1040	6	130.5	102.0	M12
	1 1/2	PSF1 1/2CR	J1040	6	130.5	102.0	M12

All dimensions in mm except inch shaft sizes

Dimensions (mm)					Weight kg
A	A1	A4	B	S	
27.8	36.3	13.4	31.0	12.7	0.28
27.8	36.3	13.4	31.0	12.7	0.28
27.9	36.7	14.3	34.0	14.3	0.34
27.9	36.7	14.3	34.0	14.3	0.34
31.5	41.4	14.3	38.1	15.9	0.50
31.5	41.4	14.3	38.1	15.9	0.50
31.5	41.4	14.3	38.1	15.9	0.50
34.8	46.9	15.5	42.9	17.5	0.74
34.8	46.9	15.5	42.9	17.5	0.74
34.8	46.9	15.5	42.9	17.5	0.74
37.5	53.2	17.1	49.2	19.0	0.98
37.5	53.2	17.1	49.2	19.0	0.98

Unit dimensions

Table 10: PSFT Silver-Lube two-bolt flange - unit dimensions

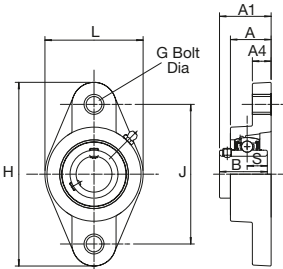

PSFT Series

Shaft diameter		RHP designation	Basic bearing insert	Housing group	Dimensions (mm)		
mm	inches				L	H	J
20		PSFT20CR	J1020	2	64.1	113.3	90.0
	3/4	PSFT3/4CR	J1020	2	64.1	113.3	90.0
25		PSFT25CR	J1025	3	68.4	130.3	99.0
	1	PSFT1CR	J1025	3	68.4	130.3	99.0
30		PSFT30CR	J1030	4	80.1	148.3	117.0
	1 3/16	PSFT1 3/16CR	J1030	4	80.1	148.3	117.0
	1/4	PSFT1/4RCR	J1030	4	80.1	148.3	117.0
35		PSFT35CR	J1035	5	90.1	163.3	130.0
	1 1/4	PSFT1 1/4CR	J1035	5	90.1	163.3	130.0
	1 7/16	PSFT1 7/16CR	J1035	5	90.1	163.3	130.0
40		PSFT40CR	J1040	6	100.1	175.3	144.0
	1 1/2	PSFT1 1/2CR	J1040	6	100.1	175.3	144.0

All dimensions in mm except inch shaft sizes

Dimensions (mm)						Weight kg
G	A	A1	A4	B	S	
M10	26.5	33.7	11.4	31.0	12.7	0.24
M10	26.5	33.7	11.4	31.0	12.7	0.24
M10	29.1	36.7	13.4	34.0	14.3	0.30
M10	29.1	36.7	13.4	34.0	14.3	0.30
M10	30.5	41.2	13.4	38.1	15.9	0.44
M10	30.5	41.2	13.4	38.1	15.9	0.44
M10	30.5	41.2	13.4	38.1	15.9	0.44
M12	32.8	43.4	16.1	42.9	17.5	0.64
M12	32.8	43.4	16.1	42.9	17.5	0.64
M12	32.8	43.4	16.1	42.9	17.5	0.64
M12	37.5	51.7	20.0	49.2	19.0	0.89
M12	37.5	51.7	20.0	49.2	19.0	0.89

Unit dimensions

Table 11: PST Silver-Lube take up units - unit dimensions

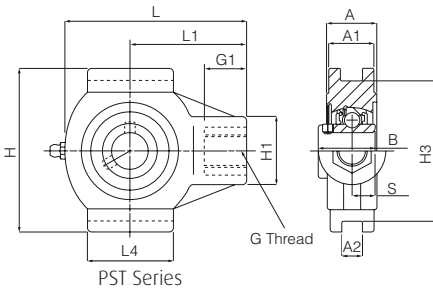

Shaft diameter		RHP designation	Basic bearing insert	Housing group	Dimensions (mm)				
mm	inches				L	L1	L4	H	H1
20		PST20CR	J1020	2	99.0	64.0	47.0	88.0	35.0
	3/4	PST3/4CR	J1020	2	99.0	64.0	47.0	88.0	35.0
25		PST25CR	J1025	3	99.0	64.0	47.0	88.0	35.0
	1	PST1CR	J1025	3	99.0	64.0	47.0	88.0	35.0
30		PST30CR	J1030	4	125.0	76.0	63.0	102.0	40.0
	1 1/16	PST1 1/16CR	J1030	4	125.0	76.0	63.0	102.0	40.0
	1 1/4	PST1 1/4RCR	J1030	4	125.0	76.0	63.0	102.0	40.0
35		PST35CR	J1035	5	125.0	76.0	63.0	102.0	40.0
	1 1/4	PST1 1/4CR	J1035	5	125.0	76.0	63.0	102.0	40.0
	1 7/16	PST1 7/16CR	J1035	5	125.0	76.0	63.0	102.0	40.0
40		PST40CR	J1040	6	140.0	85.0	80.0	114.0	40.0
	1 1/2	PST1 1/2CR	J1040	6	140.0	85.0	80.0	114.0	40.0

All dimensions in mm except inch shaft sizes

Dimensions (mm)								Weight kg
H3	G	G1	A	A1	A2	B	S	
75.8	M16X2.00	22.5	27.5	24.5	12.2	31.0	12.7	0.32
75.8	M16X2.00	22.5	27.5	24.5	12.2	31.0	12.7	0.32
75.8	M16X2.00	22.5	27.5	24.5	12.2	34.0	14.3	0.36
75.8	M16X2.00	22.5	27.5	24.5	12.2	34.0	14.3	0.36
88.8	M16X2.00	22.5	34.5	30.0	12.2	38.1	15.9	0.53
88.8	M16X2.00	22.5	34.5	30.0	12.2	38.1	15.9	0.53
88.8	M16X2.00	22.5	34.5	30.0	12.2	38.1	15.9	0.53
88.8	M16X2.00	22.5	34.5	30.0	12.2	42.9	17.5	0.74
88.8	M16X2.00	22.5	34.5	30.0	12.2	42.9	17.5	0.74
88.8	M16X2.00	22.5	34.5	30.0	12.2	42.9	17.5	0.74
101.8	M16X2.00	22.5	34.0	32.0	16.2	49.2	19.0	1.00
101.8	M16X2.00	22.5	34.0	32.0	16.2	49.2	19.0	1.00

End Covers

Polypropylene end covers are available to fit all Silver-Lube housings. End covers can be used at temperatures ranging from -20°C to +90°C. They may be used as additional protection for the bearing in adverse environmental conditions as well as an aid to meeting safety requirements.

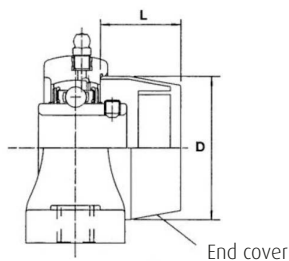

HOUSING GROUP	END COVER REFERENCE	DIMENSION D	DIMENSION L
Group 2	P20P	50.0	23.0
Group 3	P25P	55.0	25.0
Group 4	P30P	64.0	30.0
Group 5	P35P	74.0	32.0
Group 6	P40P	84.0	37.0

All dimensions in mm



Molded-Oil Inserts with Stainless Steel Housings

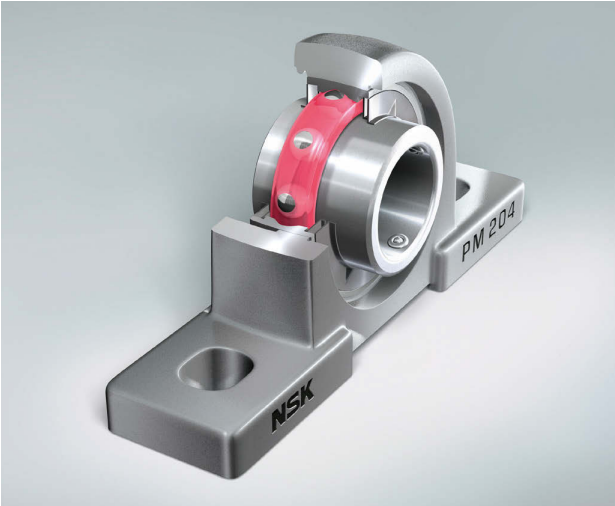

Molded-Oil stainless steel unit references

Insert Type



Housing Type



Page	Series
114	F-UCPM2
116	F-UCFM2

Molded-Oil insert references

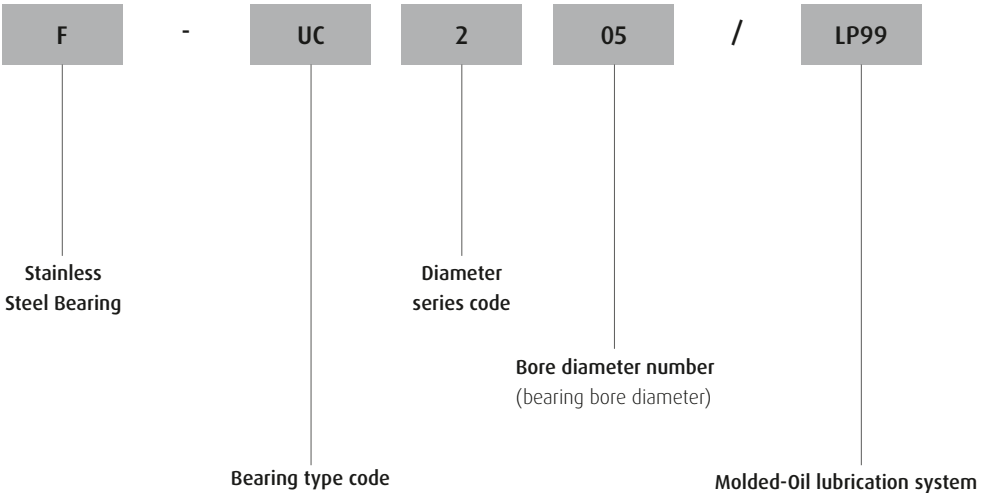

Ball bearing units stainless series

Introduction

This series provides corrosion resistance and longer lubrication life in a clean unit with low torque characteristics.

NSK ball bearing units in the stainless series feature ball bearings inserted into housings made of stainless that provide superior resistance to corrosion as compared to standard series cast iron units. This series is especially useful in a wide variety of applications because of the rust-free properties of the housing.

Molded-Oil bearings are lubricated with NSK's own oil-impregnated material, Molded-Oil. Molded-Oil consists of lubricating oil and polyolefin resin that has an affinity for oil. Oil slowly seeping from this material provides ample lubrication to the bearing for extended periods.

As oil seeping from the Molded-Oil inside the bearing provides sufficient lubrication, troublesome oil refilling is not required and contamination of the surrounding environment is prevented.

Prior to filling the bearings with Molded-Oil, their interior surfaces are specially treated. As a result, bearing torque is not much higher than that of grease-lubricated bearings.

The basic dimensions are the same as current NSK units and are also compatible with units from other manufacturers ISO standard.

Materials

	Parts	Materials
Bearing	Raceways	Martensitic stainless steel (equivalent to SUS440C)
	Ball	Martensitic stainless steel (equivalent to SUS440C)
	Flinger, Retainer	Austenitic stainless steel (equivalent to SUS304)
	Rubber Seal	Nitrile rubber
	Set Screw (W shape screw head)	Martensitic stainless steel (equivalent to SUS410)
Bearing housing		Austenitic stainless steel casting (SCS13)

Recommended operating temperature and allowable speed

Molded-Oil bearings are recommended to operate from -15 to +80°C. However, operating temperature should be below +60°C when the bearing is operated under continuous use.

dn value: $12 \cdot 10^4$ max

(dn = bore diameter in mm x speed in min⁻¹)

Remarks: This recommended operating temperature range and allowable speed is applied to all bearings with Molded-Oil bearings. Contact NSK when your application exceeds these recommendations.

Recommended tightening torques for set screws

Bearing designation (F-UC)	Designation of set screws (W shape on screw head)	Maximum tightening torque (Nm)
204, 205	M5 x 0.8	3.9
206	M6 x 0.75	4.9
207	M6 x 0.75	5.8
208-210	M8 x 1	7.8

Inner ring tolerances

Units: μm

Nominal bore diameter d		Bore diameter			Width		Radial run-out (ref.)
over mm	incl. mm	Δdmp deviations		ΔVdp variations	ΔBs deviations		max
		high	low	max	high	low	
18	31.750	+18	0	12	0	-120	18
31.750	50.800	+21	0	14	0	-120	20

Δdmp : Mean bore diameter deviation.

ΔVdp : Bore diameter variation.

ΔBs : Inner ring width deviation.

Outer ring tolerances

Units: μm

Nominal outside diameter D		ΔDm deviations			Radial run-out (ref.)
over mm	incl. mm	high		low	max
30	50	0		-11	20
50	80	0		-13	25
80	120	0		-15	35

ΔDm : Mean outside diameter deviation.

The lower deviation figure of ΔDm does not apply within a distance of ¼ the width of the outer ring from either side.

Pillow type ball bearing unit

F-UCPM2 series: Cylindrical bore, set screw type with Molded-Oil

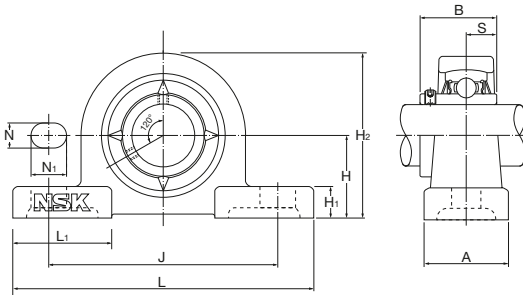

Shaft diameter mm	Unit number	Dimensions (mm)										
		H	L	J	A	N	N ₁	H ₁	H ₂	L ₁	B	S
20	F-UCPM204D0/LP99	33.3	120	95	30	12	14	11	64	42	31.0	12.7
25	F-UCPM205D0/LP99	36.5	130	105	30	12	14	12	70	42	34.1	14.3
30	F-UCPM206D0/LP99	42.9	155	121	36	17	20	13	82	54	38.1	15.9
35	F-UCPM207D0/LP99	47.6	161	127	38	17	20	14	92	54	42.9	17.5
40	F-UCPM208D0/LP99	49.2	171	137	40	17	20	14	98	52	49.2	19
45	F-UCPM209D0/LP99	54	180	146	40	17	20	14	105	60	49.2	19
50	F-UCPM210D0/LP99	57.2	195	159	45	19	22	16	114	65	51.6	19

Bolt size	Bearing number	Housing number	Mass of unit (Ref.) kg
M10	F-UC204/LP99	PM204	0.6
M10	F-UC205/LP99	PM205	0.7
M14	F-UC206/LP99	PM206	1.0
M14	F-UC207/LP99	PM207	1.3
M14	F-UC208/LP99	PM208	1.8
M14	F-UC209/LP99	PM209	2.1
M16	F-UC210/LP99	PM210	2.5

Rhombus type ball bearing unit

F-UCFM2 series: Cylindrical bore, set screw type with Molded-Oil

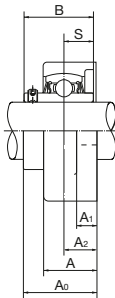
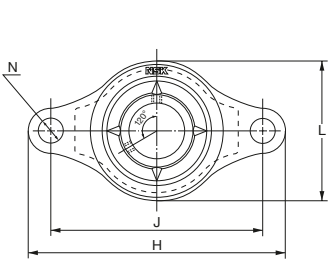

Shaft diameter mm	Unit number	Dimensions (mm)									
		H	J	A ₂	A ₁	A	N	L	A ₀	B	S
20	F-UCFM204D0/LP99	112	90	15	10	25.5	12	60	33.3	31.0	12.7
25	F-UCFM205D0/LP99	127	99	16	10	26.5	16	68	35.8	34.1	14.3
30	F-UCFM206D0/LP99	145	117	18	10	30	16	80	40.2	38.1	15.9
35	F-UCFM207D0/LP99	158	130	19	12	32	16	90	44.4	42.9	17.5
40	F-UCFM208D0/LP99	172	144	21	12	35	16	100	51.2	49.2	19
45	F-UCFM209D0/LP99	180	148	22	13	36	19	108	52.2	49.2	19
50	F-UCFM210D0/LP99	189	157	22	13	37	19	115	54.6	51.6	19

Bolt size	Bearing number	Housing number	Mass of unit (Ref.) kg
M10	F-UC204/LP99	FM204	0.5
M14	F-UC205/LP99	FM205	0.6
M14	F-UC206/LP99	FM206	0.9
M14	F-UC207/LP99	FM207	1.2
M14	F-UC208/LP99	FM208	1.6
M16	F-UC209/LP99	FM209	1.9
M16	F-UC210/LP99	FM210	2.2

Stainless insert bearing

Cylindrical bore, set screw type with Molded-Oil

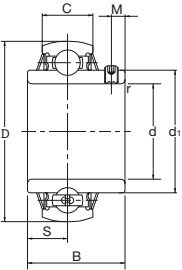

Shaft diameter mm	Unit number	Dimensions (mm)			
		D	B	C	r _{min}
20	F-UC204/LP99	47	31.0	17	1
25	F-UC205/LP99	52	34.1	17	1
30	F-UC206/LP99	62	38.1	19	1
35	F-UC207/LP99	72	42.9	20	1.5
40	F-UC208/LP99	80	49.2	21	1.5
45	F-UC209/LP99	85	49.2	22	1.5
50	F-UC210/LP99	90	51.6	24	1.5

Dimensions (mm)			Basic load rating N		Mass of unit (Ref.) kg
S	M	d1	Dynamic C _r	Static C _{or}	
12.7	4.5	29.6	9900	6650	0.17
14.3	5	33.9	10800	7850	0.20
15.9	5	40.8	15000	11300	0.33
17.5	6	46.8	19700	15300	0.49
19	8	53.0	22400	17800	0.65
19	8	57.5	25200	20400	0.70
19	9	62.4	27000	23300	0.80



Life-Lube Bearing Units

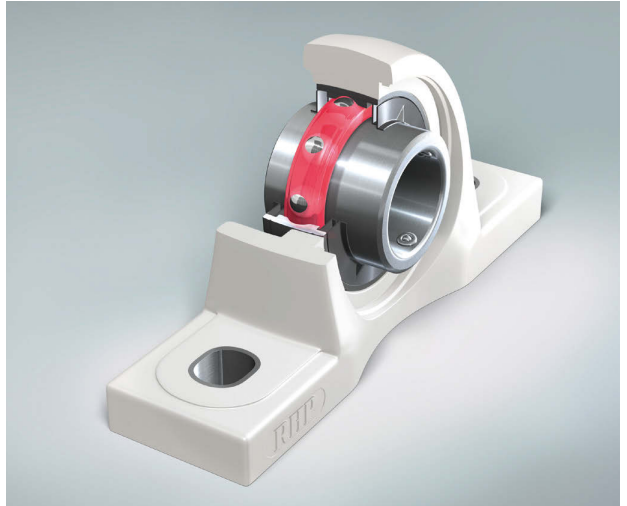

Life-Lube unit references

Insert Type



Housing Type



Page	125
126	PNP/LP99
128	PSF/LP99
130	PSFT/LP99
132	PST/LP99

Life-Lube insert references

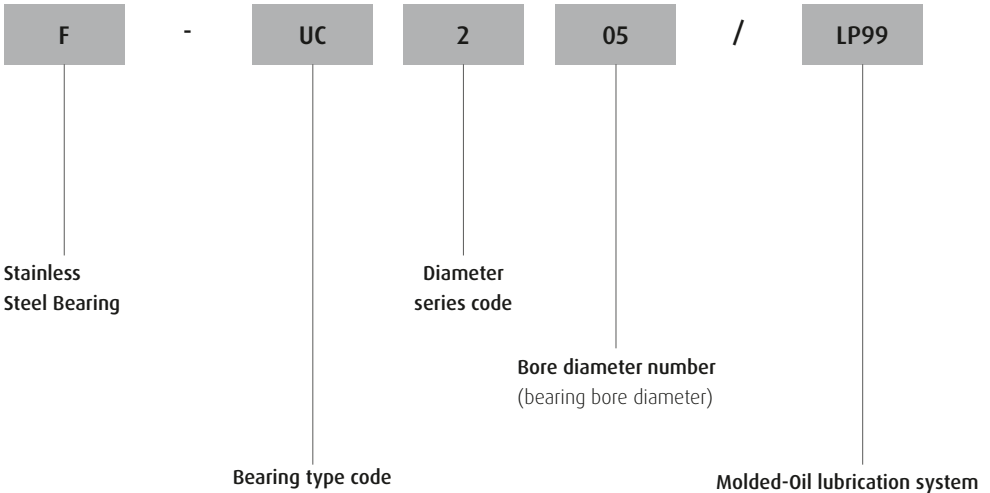

Life-Lube product range

Introduction

The Life-Lube series combine the corrosion resistant properties of Silver-Lube housings with the excellent sealing and lubricating properties of Molded-Oil inserts. Life-Lube units are specifically for use in industries where contact with water and process fluids is unavoidable, excellent chemical resistance is required and a longer lubrication life is necessary.

Life-Lube units are available in pillow block, two-bolt flange, four-bolt flange and take-up unit configurations and are capable of accommodating initial misalignment from mounting errors. In operation, the units have proven reliability in the most hostile applications.

Life-Lube housings are made from PBT thermoplastic resins which, in addition to being non-corrodible, are resistant to detergents and a wide range of chemicals. The housings are paint and coating free which prevents chipping or flaking and have smooth surfaces to assist in washdowns.

Life-Lube bearing inserts are made from stainless steel which provides superior corrosion resistance. The inserts are lubricated with NSK's own oil impregnated polymer, Molded-Oil. Oil slowly seeping from this material provides ample lubrication for the bearing for extended periods. The Molded-Oil solid lubricant resists contamination and water washout and does away with the need for relubrication. Stainless steel flingers and nitrile rubber seals are fitted as standard.

Housing strength

Housing load carrying capacity varies depending on the application loading regime, which may be intermittent, continuous or cyclical. Maximum housing loads are given in tables 1, 2, 3 and 4. These loads must not be exceeded without prior consultation with NSK.

Published housing maximum load capacities do not allow for any reduction in housing strength caused by exposure of the housing to chemicals, water, steam, heat, ultraviolet light or any combination of these factors. If any of these factors are present in the application the designer or end-user must establish the effect of these exposures and reduce the published maximum housing load accordingly.

To maximise load carrying capacity it is recommended that washers are used with the fixing bolts. Tables 1, 2 and 3 also detail maximum fixing bolt tightening torques.

Static electricity generation

Static electricity may be generated by Life-Lube bearing units under certain application conditions.

Life-Lube bearings are therefore not recommended for use in explosive or flammable environments. If Life-Lube bearing units are used in flammable or explosive applications the bearing insert must be earthed.

Housing strength

Table 1 PNP Life-Lube pillow block - housing load capacity

RHP designation	Maximum housing load (N) at 20°C												Max. fixing bolt torque (Nm)
	P1			P2			P3			P4			
	Intermittent loading	Continuous loading	Cyclical loading	Intermittent loading	Continuous loading	Cyclical loading	Intermittent loading	Continuous loading	Cyclical loading	Intermittent loading	Continuous loading	Cyclical loading	
PNP20/LP99	3500	1700	800	2800	1400	800	2600	1300	700	1300	700	400	18
PNP25/LP99	4000	2000	1000	3100	1500	800	2600	1300	700	1700	900	500	25
PNP30/LP99	5000	2500	1200	3500	1800	1000	4000	2000	1100	2600	1300	700	30
PNP35/LP99	6000	3000	1500	4300	2100	1200	4100	2100	1100	3200	1600	900	35
PNP40/LP99	10700	5300	2900	8000	4000	2200	6800	3400	1900	5200	2600	1400	40

Table 2 PSF Life-Lube four-bolt flange - housing load capacity

RHP designation	Maximum housing load (N) at 20°C						Max. fixing bolt torque (Nm)
	F1			F2			
	Intermittent loading	Continuous loading	Cyclical loading	Intermittent loading	Continuous loading	Cyclical loading	
PSF20/LP99	3100	1600	900	1300	700	400	18
PSF25/LP99	3500	1700	1000	1300	700	400	25
PSF30/LP99	4600	2300	1300	2200	1100	600	30
PSF35/LP99	6200	3100	1700	2600	1300	700	35
PSF40/LP99	6200	3100	1700	4000	2000	1100	40

Table 3 PSFT Life-Lube two-bolt flange - housing load capacity

RHP designation	Maximum housing load (N) at 20°C									Max. fixing bolt torque (Nm)
	T1			T2			T3			
	Intermittent loading	Continuous loading	Cyclical loading	Intermittent loading	Continuous loading	Cyclical loading	Intermittent loading	Continuous loading	Cyclical loading	
PSFT20/LP99	4400	2200	1200	1900	900	500	1300	700	400	18
PSFT25/LP99	4400	2200	1200	3000	1500	800	1400	700	400	25
PSFT30/LP99	5900	2900	1600	3300	1600	900	2000	1000	500	30
PSFT35/LP99	6400	3200	1700	3900	2000	1100	2800	1400	800	35
PSFT40/LP99	9000	4500	2500	3900	2000	1100	3300	1600	900	40

Table 4 PST Life-Lube take-up - housing load capacity

RHP designation	Maximum housing load (N) at 20°C		
	U		
	Intermittent loading	Continuous loading	Cyclical loading
PST20/LP99	5700	2800	1600
PST25/LP99	5400	2700	1500
PST30/LP99	8100	4000	2300
PST35/LP99	7800	3900	2200
PST40/LP99	8100	4000	2300

Note that there is no maximum fixing bolt torque applicable for take-up units.

PNP Series

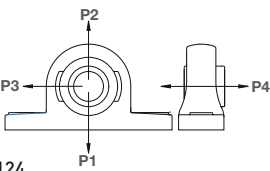

PSF Series

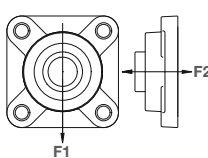

PSFT Series

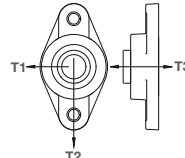

PST Series

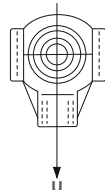

Life-Lube bearing inserts

Life-Lube bearing inserts have martensitic stainless steel rings, balls and set screws, and austenitic stainless steel cage and flingers.

Life-Lube bearing inserts are lubricated with NSK's own oil-impregnated material, Molded-Oil. Molded-Oil consists of lubricating oil and polyolefin resin that has an affinity for oil. Oil slowly seeping from this material provides ample lubrication to the bearing for extended periods. Relubrication is not necessary for Life-Lube Molded-Oil inserts.

Recommended operating temperature and allowable speed

Molded-Oil inserts are recommended to operate from -15 to +80°C. However, operating temperature should be below +60°C when the bearing is operated under continuous use.

Allowable speed:

dn value : 12×10^4 max

(dn = bore diameter in mm x speed in rpm)

Remarks: This recommended operating temperature range and allowable speed applies to all units with Molded-Oil inserts. Contact NSK when your application exceeds these recommendations.

Materials

	Parts	Materials
Bearing	Bearing Rings	Martensitic stainless steel (equivalent to SUS440C)
	Ball	Martensitic stainless steel (equivalent to SUS440C)
	Flinger	Austenitic stainless steel (equivalent to SUS302)
	Seal	Nitrile rubber
	Set Screw	Martensitic stainless steel (equivalent to SUS410)
Bearing housing		Thermo Plastic PBT

Set screw tightening torques

Set screws for Life-Lube bearing inserts are manufactured from stainless steel and can fracture if overtightened. The limiting set screw torques listed in Table 5 should not be exceeded.

Recommended tightening torques for set screws

Insert designation	Designation of set screws	Maximum tightening torque (Nm)
F-UC204/LP99	M5 x 0.8	3.9
F-UC205/LP99	M5 x 0.8	3.9
F-UC206/LP99	M6 x 0.75	4.9
F-UC207/LP99	M6 x 0.75	5.8
F-UC208/LP99	M8 x 1	7.8

Inner ring tolerances

Units: μm

Nominal bore diameter d		Bore diameter			Width		Radial runout (ref.)
over mm	incl. mm	Δdmp deviations		ΔVdp variations max	ΔBs deviations		max
		high	low		high	low	
18	31.750	+18	0	12	0	-120	18
31.750	50.800	+21	0	14	0	-120	20

Δdmp : Mean bore diameter deviation.

ΔVdp : Bore diameter variation.

ΔBs : Inner ring width deviation.

Outer ring tolerances

Units: μm

Nominal outside diameter D		ΔDm deviations		Radial runout (ref.)
over mm	incl. mm	high	low	max
50	80	0	-13	25
80	120	0	-15	35

ΔDm : Mean outside diameter deviation.

The lower deviation figure of ΔDm does not apply within a distance of $\frac{1}{4}$ the width of the outer ring from either side.

Unit dimensions

Table 1: PNP/LP99 Life-Lube pillow block - unit dimensions

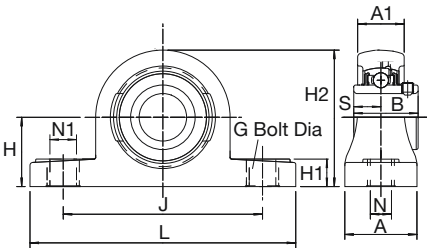

PNP/LP99 Series

Shaft diameter mm	RHP designation	Basic insert	Housing group	Dimensions (mm)			
				L	H	H1	H2
20	PNP20/LP99	F-UC204/LP99	2	127.2	33.3	14.2	65.9
25	PNP25/LP99	F-UC205/LP99	3	140.2	36.5	14.5	71.9
30	PNP30/LP99	F-UC206/LP99	4	162.2	42.9	17.8	83.9
35	PNP35/LP99	F-UC207/LP99	5	167.2	47.6	18.0	94.9
40	PNP40/LP99	F-UC208/LP99	6	184.2	49.2	19.5	98.9

Dimensions (mm)								Weight kg
J	N	N1	G	A	A1	B	S	
94.9	11	14.2	M10	37.8	22.5	31.0	12.7	0.27
104.9	11	14.2	M10	37.8	24.5	34.0	14.3	0.39
118.9	14	18.2	M12	45.8	27.0	38.1	15.9	0.52
126.9	14	18.2	M12	47.8	32.5	42.9	17.5	0.72
136.8	14	18.2	M12	53.8	36.0	49.2	19.0	0.99

Unit dimensions

Table 2: PSF/LP99 Life-Lube four-bolt flange - unit dimensions

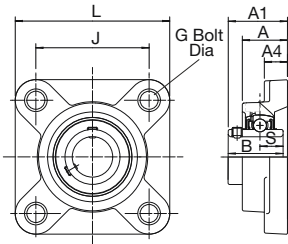

PSF/LP99 Series

Shaft diameter mm	RHP designation	Basic insert	Housing group	Dimensions (mm)		
				L	J	G
20	PSF20/LP99	F-UC204/LP99	2	86.5	63.5	M10
25	PSF25/LP99	F-UC205/LP99	3	95.0	70.0	M10
30	PSF30/LP99	F-UC206/LP99	4	107.5	83.0	M10
35	PSF35/LP99	F-UC207/LP99	5	117.5	92.0	M12
40	PSF40/LP99	F-UC208/LP99	6	130.5	102.0	M12

Dimensions (mm)					Weight kg
A	A1	A4	B	S	
27.8	36.3	13.4	31.0	12.7	0.28
27.9	36.7	14.3	34.0	14.3	0.34
31.5	41.4	14.3	38.1	15.9	0.50
34.8	46.9	15.5	42.9	17.5	0.74
37.5	53.2	17.1	49.2	19.0	0.99

Unit dimensions

Table 3: PSFT/LP99 Life-Lube two-bolt flange - unit dimensions

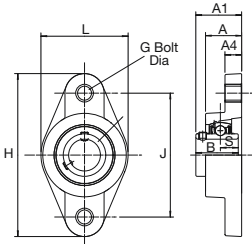

PSFT/LP99 SERIES

Shaft diameter mm	RHP designation	Basic insert	Housing group	Dimensions (mm)		
				L	H	J
20	PSFT20/LP99	F-UC204/LP99	2	64.1	113.3	90.0
25	PSFT25/LP99	F-UC205/LP99	3	68.4	130.3	99.0
30	PSFT30/LP99	F-UC206/LP99	4	80.1	148.3	117.0
35	PSFT35/LP99	F-UC207/LP99	5	90.1	163.3	130.0
40	PSFT40/LP99	F-UC208/LP99	6	100.1	175.3	144.0

G	Dimensions (mm)					Weight kg
	A	A1	A4	B	S	
M10	26.5	33.7	11.4	31.0	12.7	0.24
M10	29.1	36.7	13.4	34.0	14.3	0.30
M10	30.5	41.2	13.4	38.1	15.9	0.44
M12	32.8	43.4	16.1	42.9	17.5	0.64
M12	37.5	51.7	20.0	49.2	19.0	0.89

Unit dimensions

Table 4: PST/LP99 Life-Lube take up - unit dimensions

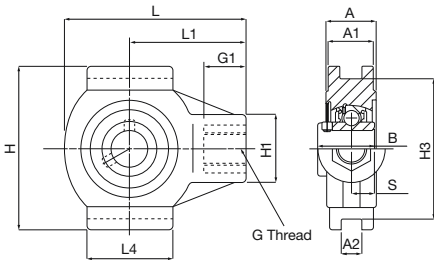

PST/LP99 Series

Shaft diameter mm	RHP designation	Basic insert	Housing group	Dimensions (mm)				
				L	L1	L4	H	H1
20	PST20/LP99	F-UC204/LP99	2	99.0	64.0	47.0	88.0	35.0
25	PST25/LP99	F-UC205/LP99	3	99.0	64.0	47.0	88.0	35.0
30	PST30/LP99	F-UC206/LP99	4	125.0	76.0	63.0	102.0	40.0
35	PST35/LP99	F-UC207/LP99	5	125.0	76.0	63.0	102.0	40.0
40	PST40/LP99	F-UC208/LP99	6	140.0	85.0	80.0	114.0	40.0

H3	G	G1	Dimensions (mm)					S	Weight kg
			A	A1	A2	B			
75.8	M16X2.00	22.5	27.5	24.5	12.2	31.0	12.7	0.32	
75.8	M16X2.00	22.5	27.5	24.5	12.2	34.0	14.3	0.36	
88.8	M16X2.00	22.5	34.5	30.0	12.2	38.1	15.9	0.53	
88.8	M16X2.00	22.5	34.5	30.0	12.2	42.9	17.5	0.74	
101.8	M16X2.00	22.5	34.0	32.0	16.2	49.2	19.0	1.00	

Life-Lube insert bearing

Cylindrical bore, set screw type with Molded-Oil

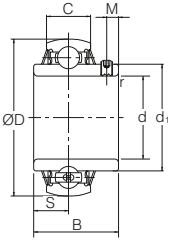

Shaft diameter mm	Unit number	Dimensions (mm)			
		D	B	C	r _{min}
20	F-UC204/LP99	47	31	17	1
25	F-UC205/LP99	52	34.1	17	1
30	F-UC206/LP99	62	38.1	19	1
35	F-UC207/LP99	72	42.9	20	1.5
40	F-UC208/LP99	80	49.2	21	1.5
45	F-UC209/LP99	85	49.2	22	1.5

Dimensions (mm)			Basic load rating N		Mass (approx.)
S	M	d1	Dynamic C _r	Static C _{or}	kg
12.7	4.5	29.6	9900	6650	0.17
14.3	5	33.9	10800	7850	0.20
15.9	5	40.8	15000	11300	0.33
17.5	6	46.8	19700	15300	0.49
19	8	53.0	22400	17800	0.65
19	8	57.5	25200	20400	0.70



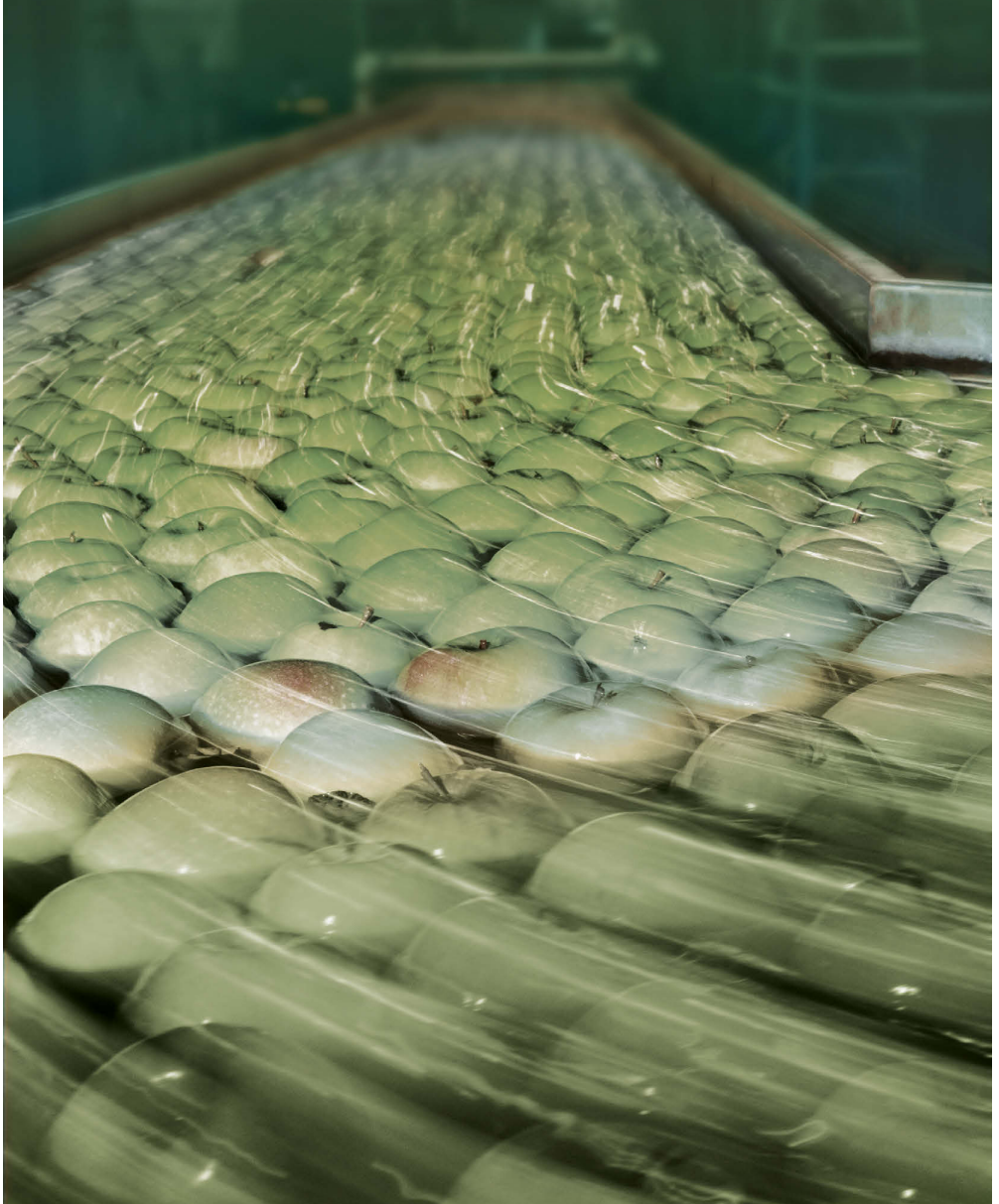

Additional products

By design the Self-Lube family of mounted units can be combined to form alternative ranges of insert and housing depending on customer requirements. This is relatively straightforward but NSK should always be consulted.

In addition NSK recognises the need for 'tailor made' solutions and is always willing to help customers who have a requirement for something out of the ordinary, commensurate with meeting certain price and volume criteria.

NSK has facilities to make special batches of product combinations such as:

- › Alternative insert / housing combinations
- › Special grease types and grease fills
- › Alternative seal combinations - flinger seals, triple lip seals and shields

Please contact NSK with your requirements.

HLT Self-Lube

HLT Self Lube inserts are designed to operate reliably at extreme temperatures, within the range -40°C to $+180^{\circ}\text{C}$. HLT inserts are available across the entire Self-Lube range.

HLT Inserts have:

- › High strength steel cage
- › Special internal geometry
- › High performance Kluber grease
- › Silicone seals
- › Optional protector
- › Relubrication facility

Special Housing Options

Where there are requirements for original equipment NSK can design special housings to accommodate customers' requirements subject to volumes required.

A typical example of this is shown below.

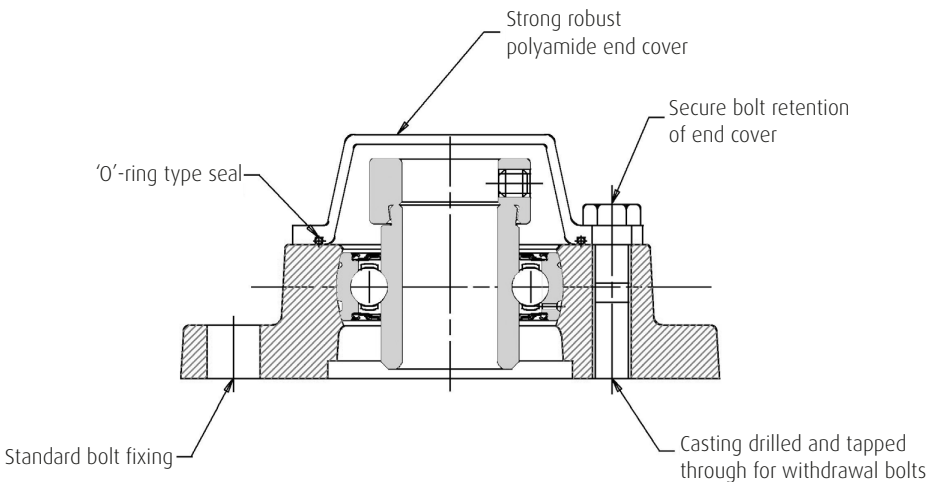

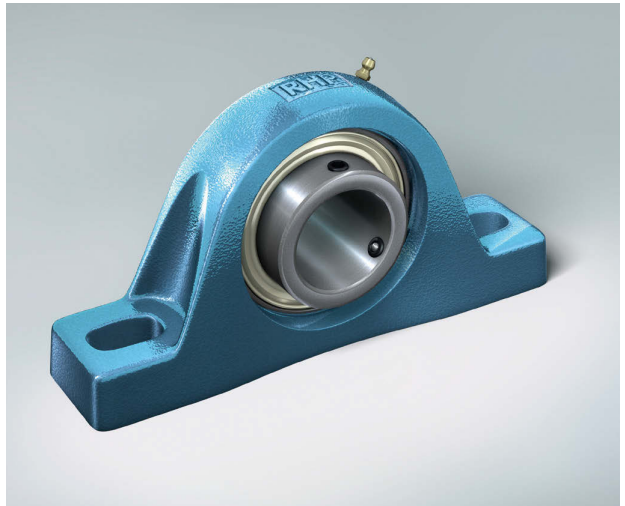

Interchange list

Series reference	Manufacturer	RHP and NSK replacement bearing series	
B	Asahi	1200G	RHP
B200	Asahi	AS200	RHP
B-B	Asahi	1200G	RHP
BF200	Asahi	SF-A	RHP
BFC200	Asahi	FC-A	RHP
BFL200	Asahi	SFT-A	RHP
BLCTE200	Asahi	ASFD200	NSK
BP200	Asahi	NP-A	RHP
BPF	Asahi	SLFE-A	RHP
BPF200	Asahi	ASPF200	NSK
BPFL	Asahi	SLFA	RHP
BPFL200	Asahi	ASPFL200	NSK
BPP	Asahi	LPB-A	RHP
BPP200	Asahi	ASPP200	NSK
BT200	Asahi	ST-A	RHP
CS200ZZ	Asahi	CS200LLU	RHP
FHF200	Asahi	FC-EC	RHP
FHLCTE200	Asahi	AELFD200	NSK
FHPF200	Asahi	AELPF200	NSK
FHPFL200	Asahi	AELPFL200	NSK
FHR200ER(U)	Asahi	1300EC	RHP
FHT200	Asahi	ST-EC	RHP
KH200+ER	Asahi	AEL200	NSK
SER	Asahi	1100CG	RHP
UC300	Asahi	UC300	NSK
UCEH200	Asahi	UCHB200	NSK
UCF200	Asahi	UCF200	NSK
UCFC200	Asahi	UCFC200	NSK
UCFCX00	Asahi	UCFCX00	NSK
UCFK200	Asahi	UCFH200	NSK
UCFL200	Asahi	UCFL200	NSK
UCFLX00	Asahi	UCFLX00	NSK
UCFX00	Asahi	UCFX00	NSK
UCLF200(U)	Asahi	SF	RHP
UCLP200(U)	Asahi	SL	RHP
UCP200	Asahi	UCP200	NSK
UCPA200	Asahi	UCUP200	NSK
UCPX00	Asahi	UCPX00	NSK
UCST200(U)	Asahi	ST	RHP
UCT200	Asahi	UCT200	NSK
UCW200	Asahi	1000G	RHP
UD200EEA	Asahi	1200CEG	RHP
UDF200A	Asahi	SF-EC	RHP
UDFL200B	Asahi	SFT-EC	RHP
UDT200A	Asahi	NP-EC	RHP
UDT200B	Asahi	ST-EC	RHP
UG200+ER	Asahi	UEL200	NSK
UGF200	Asahi	UELF200	NSK
UGFC200	Asahi	UELFC200	NSK
UGFL200	Asahi	UELFL200	NSK
UGP200	Asahi	UEL200	NSK
UGT200	Asahi	UEL200	NSK
UH200UR(U)	Asahi	1200EC	RHP
UHF200	Asahi	SF-EC	RHP
UHFL200	Asahi	SFT-EC	RHP
UHP200	Asahi	NP-EC	RHP
UHPP200	Asahi	AELPP200	NSK
UK200	Asahi	UK200	NSK
UCP200	Asahi, FYH, Koyo, Nachi, NBR, NSK, NTN	NP	RHP
UCT200	Asahi, FYH, Koyo, Nachi, NBR, NSK, NTN	ST	RHP
UCPX	Asahi, FYH, Koyo, NSK	MP	RHP

Series reference	Manufacturer	RHP and NSK replacement bearing series	
UCTX	Asahi, FYH, Koyo, NSK	MST	RHP
UCX	Asahi, FYH, Koyo, NSK	1000G	RHP
UC200	Asahi, FYN, Koyo, Nachi, NBR, NSK, NTN	1000G	RHP
UCF200	Asahi, FYN, Koyo, Nachi, NBR, NSK, NTN	SF	RHP
UCFL200	Asahi, FYN, Koyo, Nachi, NBR, NSK, NTN	SFT	RHP
UCFX	Asahi, FYN, Koyo, NSK	MSF	RHP
UCLFX	Asahi, FYN, Koyo, NSK	MSFT	RHP
FG200ER(U)	Asahi, Nachi	1000DECG	RHP
FGAK200	Asahi, Nachi	SL-DEC	RHP
FH200ER(U)	Asahi, Nachi	1200EC	RHP
FNR-R	BCA	SF-EC	RHP
PNR-R	BCA	SL-EC	RHP
PNR-RS	BCA	NP-EC	RHP
PWG-R	BCA	SL-DEC	RHP
PWG-RS	BCA	NP-DEC	RHP
TNR-R	BCA	SFT-EC	RHP
FB200	Browning	SF-EC	RHP
FB230	Browning	SFT-EC	RHP
FB250	Browning	SF	RHP
FB260	Browning	SFT	RHP
FB350	Browning	MSF	RHP
PB200	Browning	SL-EC	RHP
PB221	Browning	NP-EC	RHP
PB250	Browning	SL	RHP
PB251	Browning	NP	RHP
PB350	Browning	MP	RHP
1000KRR	Fafnir	1100DEC	RHP
200NPPB	Fafnir	1726200-2RS	RHP
FLCTE	Fafnir	LFTC-EC	RHP
GC-KRRB	Fafnir	1000G	RHP
GC-KRRG2	Fafnir	1100CG	RHP
GE-KPPB	Fafnir	T1000DECG	RHP
GE-KRRB	Fafnir	1000DECG	RHP
G-KPPB3	Fafnir	T1000DECG	RHP
GLCTE	Fafnir	LFTC-EC	RHP
GRAE-NPPB	Fafnir	1200CEG	RHP
GW208PPB5	Fafnir	1/PDNF240/9G	RHP
GW208PPB6	Fafnir	1/PDNF240/8G	RHP
GW208PPB8	Fafnir	PDNF240/9G	RHP
GW209PPB11	Fafnir	28/DNF245-45G	RHP
GW209PPB2	Fafnir	PDNF145-45G	RHP
GW209PPB5	Fafnir	PDNF245/10G	RHP
GW209PPB8	Fafnir	DNF245/10G	RHP
GW210PP4	Fafnir	PDF150/9G	RHP
GW210PPB2	Fafnir	PDNF150-1.15/16G	RHP
GW210PPB4	Fafnir	PDNF150/9G	RHP
GW211PP2	Fafnir	PDF155-2.3/16G	RHP
GW211PP3	Fafnir	PDF155/12G	RHP
PASE	Fafnir	NP-EC	RHP
PB	Fafnir	LPB-EC	RHP
PCF	Fafnir	SF-EC	RHP
PCFT	Fafnir	SFT-EC	RHP
PHE	Fafnir	SCH-EC	RHP
PMNE	Fafnir	FC-EC	RHP
PSHE	Fafnir	SNP-EC	RHP
PTUE	Fafnir	ST-EC	RHP

Series reference	Manufacturer	RHP and NSK replacement bearing series	
RA	Fafnir	SLFE-EC	RHP
RAE...NPP	Fafnir	1300EC	RHP
RAKC	Fafnir	SL	RHP
RAKHP	Fafnir	MP	RHP
RASC	Fafnir	NP	RHP
RASE	Fafnir	NP-DEC	RHP
RAT	Fafnir	SLFL-EC	RHP
RATR	Fafnir	SLFT-EC	RHP
RC	Fafnir	SLC-DEC	RHP
RCC	Fafnir	SLC	RHP
RCE	Fafnir	SLC-DEC	RHP
RCHP	Fafnir	MSC	RHP
RCJ	Fafnir	SF-DEC	RHP
RCJHP	Fafnir	MSF	RHP
RCJSP	Fafnir	SF	RHP
RCJT	Fafnir	SFT-DEC	RHP
RCJTC	Fafnir	SFT	RHP
RCJTE	Fafnir	SFT-DEC	RHP
RCJTHP	Fafnir	MSFT	RHP
RCJTP	Fafnir	SFT	RHP
RFC	Fafnir	MFC	RHP
RFHP	Fafnir	MFC	RHP
RHCM	Fafnir	SCHB	RHP
RHE	Fafnir	SCH-DEC	RHP
RMNE	Fafnir	FC-DEC	RHP
RMNEY	Fafnir	FC	RHP
RPB	Fafnir	LPBR-EC	RHP
RR	Fafnir	SLFE-RR	RHP
RRC	Fafnir	SLFE	RHP
RRT	Fafnir	SLFL-DEC	RHP
RRTR	Fafnir	SLFT-DEC	RHP
RSHE	Fafnir	SNP-DEC	RHP
RTUE	Fafnir	ST-DEC	RHP
RTUHP	Fafnir	MST	RHP
RTUP	Fafnir	ST	RHP
TAS	Fafnir	TNP-DEC	RHP
TASE	Fafnir	TNP-DEC	RHP
TCJ	Fafnir	TSF-DEC	RHP
TCJT	Fafnir	TSFT-DEC	RHP
THE	Fafnir	TSCH-DEC	RHP
TMNE	Fafnir	TFC-DEC	RHP
TMNE	Fafnir	TFC-DEC	RHP
TSHE	Fafnir	TSNP-DEC	RHP
TTUE	Fafnir	TST-DEC	RHP
VAK	Fafnir	SL-EC	RHP
VAK	Fafnir	SL-EC	RHP
VAS	Fafnir	NP-EC	RHP
VAS	Fafnir	NP-EC	RHP
V CJ	Fafnir	SF-EC	RHP
V CJ	Fafnir	SF-EC	RHP
V CJT	Fafnir	SFT-EC	RHP
V CJT	Fafnir	SFT-EC	RHP
VMNE	Fafnir	FC-EC	RHP
VMNE	Fafnir	FC-EC	RHP
VSHE	Fafnir	SNP-EC	RHP
VSHE	Fafnir	SNP-EC	RHP
W208PP10	Fafnir	36/DF140-1.12	RHP
W208PP5	Fafnir	2/DF240/9	RHP
W208PP6	Fafnir	2/DF240/8	RHP
W208PP8	Fafnir	PDF240/9	RHP
W208PP9	Fafnir	PDNF240/8	RHP
W208PPB13	Fafnir	2/DF240/7	RHP
W208PPB2	Fafnir	36/PDNF140-1.12	RHP
W208PPB4	Fafnir	PDNF140-1.316	RHP
W208PPB5	Fafnir	2/DF240/9	RHP
W208PPB6	Fafnir	2/DF240/8	RHP

Series reference	Manufacturer	RHP and NSK replacement bearing series	
W208PPB7	Fafnir	2/DF140-1.316	RHP
W208PPB8	Fafnir	PDNF240/9	RHP
W208PPB9	Fafnir	PDNF240/8	RHP
W209PPB2	Fafnir	PDF145-45	RHP
W209PPB4	Fafnir	28/PDNF145-1.12	RHP
W209PPB5	Fafnir	PDNF245/10	RHP
W209PPB8	Fafnir	DNF245/10	RHP
W210PP2	Fafnir	PDF150-1.1516	RHP
W210PP4	Fafnir	PDF150/9	RHP
W210PPB2	Fafnir	PDNF150-1.1516	RHP
W210PPB4	Fafnir	PDNF150/9	RHP
W210PPB5	Fafnir	5/PDNF150-1.34	RHP
W210PPB6	Fafnir	PDNF250/9	RHP
W211PP2	Fafnir	PDF155-2.316	RHP
W211PP3	Fafnir	PDF155/12	RHP
W211PPB2	Fafnir	PDNF155-2.316	RHP
W211PPB3	Fafnir	PDF155/12	RHP
200NPPB	Fafnir, INA	1726200-2RS	RHP
GE-KPPB3	Fafnir, INA	I1000DECG	RHP
G-KRRB	Fafnir, INA	1000DECG	RHP
GRA-NPPB	Fafnir, INA	1200ECG	RHP
PB	Fafnir, INA	LPB-EC	RHP
RAE-NPPB	Fafnir, INA	1200EC	RHP
RAK	Fafnir, INA	SL-DEC	RHP
RA-NPP	Fafnir, INA	1300EC	RHP
RA-NPPB	Fafnir, INA	1200EC	RHP
RSHE	Fafnir, INA	SNP-DEC	RHP
TC-J	Fafnir, INA	TSF-DEC	RHP
TCJT	Fafnir, INA	TSFT-DEC	RHP
36200	FAG	1000DECG	RHP
56200	FAG	1000G	RHP
76200	FAG	1726200-2RS	RHP
76200B.2RSR	FAG	1726200-2RS	RHP
FB16200	FAG	SLFE-EC	RHP
FB56200	FAG	SLFE	RHP
FG16200	FAG	SF-EC	RHP
FG56200	FAG	SF	RHP
H	FAG	H	RHP
KM	FAG	AN	RHP
SB16200	FAG	LPB-EC	RHP
SC16200	FAG	NP-EC	RHP
SG36200	FAG	NP-DEC	RHP
SG56200	FAG	NP	RHP
E200	FYH	1100CG	RHP
NA200	FYH	1000DECG	RHP
NANF200	FYH	SF-DEC	RHP
NANFL200	FYH	SFT-DEC	RHP
NAP200	FYH	NP-DEC	RHP
NASL200	FYH	SL-DEC	RHP
NAT-E	FYH	ST-DEC	RHP
RB200	FYH	1100	RHP
SA200	FYH	1200EC	RHP
SAA200	FYH	1300EC	RHP
SAF-FE	FYH	SF-EC	RHP
SAFL-FE	FYH	SFT-EC	RHP
SAP200	FYH	NP-EC	RHP
SAPF200	FYH	SLFE-EC	RHP
SAPP200F	FYH	LPB-A	RHP
SASL200F	FYH	SL-EC	RHP
SBPF200	FYH	SLFL-A	RHP
SBP200F	FYH	LPB-EC	RHP
SC200	FYH	1726200-2RS	RHP
UCHA200	FYH	SCHB	RHP
UCS200N	FYH	1100CG	RHP

Interchange list

Series reference	Manufacturer	RHP and NSK replacement bearing series	
UK200	FYH, Koyo, Nachi, NBR, NSK, NTN	1000-KG	RHP
UKP200	FYH, Koyo, Nachi, NBR, NSK, NTNNTN1000-k	RHP	
UCPA200	FYH, Koyo, NSK	SNP	RHP
UCF200	FYH, Koyo, NSK, NTN	FC	RHP
UKT200	FYH, Koyo, NSK, NTN	MST1000-K	RHP
UKF200	FYH, Nachi, NBR, NSK, NTN	MSF1000-K	RHP
UKFL200	FYH, Nachi, NBR, NSK, NTN	MSFT1000-K	RHP
SB200	FYH, NBR	1200G	RHP
EW	Hoffmann, Pollard	FT	RHP
RMS	Hoffmann, Pollard	MRJ	RHP
2-NPPB	INA	1726200-2RS	RHP
E..KRR	INA	1100DEC	RHP
E-KRR	INA	1100DEC	RHP
FLCTE	INA	LFTC-EC	RHP
FLCTE / GLCTE	INA	LFTC-EC	RHP
FLCTEY	INA	LFTC-A	RHP
G..KRRBW	INA	1000DEC	RHP
GAY-NPPB	INA	1200G	RHP
GE..KRRB FA101T	INA	1000DECGHLT	RHP
GE..KRRB-CC	INA	1000DECGFS	RHP
GE-KPPB3	INA	T1000DECG	RHP
GE-KRRB	INA	1000DECG	RHP
GLCTE	INA	LFTC-EC	RHP
GLCTEY	INA	LFTC-A	RHP
GRA..NPPBW	INA	1200ECG	RHP
GRAE-NPPB	INA	1200ECG	RHP
GSH-RRB	INA	1000KG	RHP
GY..KRRBW	INA	1000G	RHP
GYE..KRRB VA	INA	J1000GCR	RHP
GYE-KRRB	INA	1000G	RHP
GY-KRRB	INA	1000G	RHP
PAK	INA	SL-EC	RHP
PAKY	INA	SL-EC	RHP
PASE	INA	NP-EC	RHP
PASEY	INA	NP-A	RHP
PB	INA	LPB-EC	RHP
PBY	INA	LPB-A	RHP
PCJ	INA	SF-EC	RHP
PCJT	INA	SFT-EC	RHP
PCJTY	INA	SFT-A	RHP
PCJY	INA	SF-A	RHP
PHE	INA	SCH-EC / SCHB-EC	RHP
PHEY	INA	SCH-A / SCHB-A	RHP
PHUSE	INA	BT-EC+ BTHF	RHP
PME	INA	FC-EC	RHP
PMEY	INA	FC-A	RHP
PSHE	INA	SNP-EC	RHP
PSHEY	INA	SNP-A	RHP
PTUE	INA	ST-EC	RHP
PTUEY	INA	ST-A	RHP
RA	INA	SLFE-EC	RHP
RA..NPPW	INA	1300EC	RHP
RACEY	INA	NP	RHP
RAE..NPP	INA	1300EC	RHP
RAKY	INA	SL	RHP
RASE	INA	NP-DEC	RHP
RASE..FA101T	INA	NP-HLT	RHP
RASEA	INA	NP1000KG	RHP

Series reference	Manufacturer	RHP and NSK replacement bearing series	
RASEY	INA	NP	RHP
RASEY..TN VA	INA	PNP-CR	RHP
RAT	INA	SLFL-EC	RHP
RATR	INA	SLFT-EC	RHP
RATRY	INA	SLFT-A	RHP
RATY	INA	SLFL-A	RHP
RAY	INA	SLFE-A	RHP
RB	INA	LPB-DEC	RHP
RBV	INA	LPB	RHP
RCJ	INA	SF-DEC	RHP
RCJ..FA101T	INA	SF-HLT	RHP
RCJT	INA	SFT-DEC	RHP
RCJT..FA101T	INA	SFT-HLT	RHP
RCJTA	INA	SFT1000KG	RHP
RCJTY	INA	SFT	RHP
RCJY	INA	SF	RHP
RCJY..TN VA	INA	PSF-CR	RHP
RHE	INA	SCH-DEC / SCHB-DEC	RHP
RHEY	INA	SCH/SCHB	RHP
RME	INA	FC-DEC	RHP
RMEY	INA	FC	RHP
RR	INA	SLFE-DEC	RHP
RRT	INA	SLFL-DEC	RHP
RRTR	INA	SLFT-DEC	RHP
RRTY	INA	SLFL	RHP
RRY	INA	SLFE	RHP
RSHE	INA	SNP-DEC	RHP
RSHEY	INA	SNP	RHP
RTT	INA	TSLFL-DEC	RHP
RTRR	INA	TSLFT-DEC	RHP
RTUE	INA	ST-DEC	RHP
RTUEY	INA	ST	RHP
TASE	INA	TNP-DEC	RHP
TASE	INA	TNP-DEC	RHP
TB	INA	TLPB-DEC	RHP
TCJ	INA	TSF-DEC	RHP
TCJT	INA	TSFT-DEC	RHP
TCJTY..TN VA	INA	PSFT-CR	RHP
THE	INA	TSCH-DEC / TSCHB-DEC	RHP
TME	INA	TFC-DEC	RHP
TME	INA	TFC-DEC	RHP
TR	INA	TSLFE-DEC	RHP
TSHE	INA	TSNP-DEC	RHP
TSHE	INA	TSNP-DEC	RHP
TTUE	INA	TST-DEC	RHP
TTUE	INA	TST-DEC	RHP
YE-KRR	INA	1100	RHP
Y-KRR	INA	1100	RHP
CB200	Koyo	172620000-2RS	RHP
GAT100-2RSB	Koyo	1000DECG	RHP
GAP1100B	Koyo	NP-EC	RHP
GAPL1100B	Koyo	SL-DEC	RHP
GARA100-2RSA	Koyo	1200ECG	RHP
GARAF100A	Koyo	SF-EC	RHP
GARAF1100A	Koyo	SFT-EC	RHP
GARAP100A	Koyo	NP-EC	RHP
GARAPL100A	Koyo	SL-EC	RHP
GFF1100B	Koyo	SF-DEC	RHP
GFFL1100B	Koyo	SFT-DEC	RHP
HFC	Koyo	MFC	RHP
HV-(M)	Koyo	MST	RHP
LC	Koyo	SLC	RHP
LV-(M)	Koyo	ST	RHP
PB	Koyo	1200G	RHP
PF-A	Koyo	SLFE-EC	RHP
PF-M	Koyo	SLFE	RHP

Series reference	Manufacturer	RHP and NSK replacement bearing series	
PFT1100B	Koyo	SLFE-DEC	RHP
RA100	Koyo	1200EC	RHP
SCHB	Koyo	SCHB	RHP
SP	Koyo	LPB-A	RHP
SP100A	Koyo	LPB-EC	RHP
F3Y200N	Link Belt	SF-DEC	RHP
FX3Y200N	Link Belt	SFT-DEC	RHP
P3Y200N	Link Belt	NP-DEC	RHP
PL3Y200N	Link Belt	SL-DEC	RHP
C25	McGill	NP	RHP
C35	McGill	NP	RHP
CL25	McGill	SL	RHP
FC2-25	McGill	SFT	RHP
FC2-35	McGill	MSFT	RHP
FC4-25	McGill	SF	RHP
FC4-35	McGill	MSF	RHP
ER	McGill Sealmaster	1100CG	RHP
BPF-B	Nachi	SLFE-A	RHP
BPP-B	Nachi	LPB-A	RHP
FHPR200	Nachi	LPBR-EC	RHP
SA200	NBR	1200CEG	RHP
SAFL200	NBR	SLFL-EC	RHP
SAP200	NBR	LPB-EC	RHP
SAY200	NBR	SLFE-EC	RHP
SBF200	NBR	SLFE-A	RHP
SBFL200	NBR	SLFL-A	RHP
SBP200	NBR	LPB-A	RHP
2FE	NDH	SFT-EC	RHP
2FS	NDH	SFT	RHP
4FE	NDH	SF-EC	RHP
4FS	NDH	SF	RHP
HPE	NDH	NP-EC	RHP
HPS	NDH	NP	RHP
PE	NDH	SL-EC	RHP
PS	NDH	SL	RHP
R2FE	NDH	SFT-EC	RHP
R2FS	NDH	SFT	RHP
R4FE	NDH	SF-EC	RHP
R4FS	NDH	SF	RHP
RHPE	NDH	NP-EC	RHP
RHPS	NDH	NP	RHP
RPE	NDH	SL-EC	RHP
RPS	NDH	SL	RHP
CS-DDU	NSK	1726200-2RS	RHP
EM200	NSK	1200EC	RHP
EMR200	NSK	1300EC	RHP
EN200	NSK	1200EC	RHP
ENFL200	NSK	SFT-EC	RHP
ENP200	NSK	NP-EC	RHP
ENPF200	NSK	SLFE-EC	RHP
ENPP200	NSK	LPB-EC	RHP
ENPPR200	NSK	LPBR-EC	RHP
ENR200	NSK	1300EC	RHP
EW200	NSK	1000DECG	RHP
EWFC200	NSK	FC-DEC	RHP
EFWH200	NSK	SF-DEC	RHP
EWFL200	NSK	SFT-DEC	RHP
EWFLH200	NSK	TSFT-DEC	RHP
EWPA200	NSK	NP-DEC	RHP
EWPA200	NSK	SNP-DEC	RHP
EWPLL200	NSK	SL-DEC	RHP
EWT200	NSK	ST-DEC	RHP
GEM200	NSK	1200CEG	RHP
GEMTR200J	NSK	ST-EC	RHP
UB200	NSK	1200G	RHP
UBF200	NSK	SF-A	RHP

Series reference	Manufacturer	RHP and NSK replacement bearing series	
UBFC200	NSK	FC-A	RHP
UBFD200	NSK	LFTC-A	RHP
UBFL200	NSK	SFT-A	RHP
UBP200	NSK	NP-A	RHP
UBPD200	NSK	SNP-A	RHP
UBPF200	NSK	SLFE-A	RHP
UBPP200	NSK	LPBR-A	RHP
UCEH200	NSK	SCHB	RHP
AEL200	NTN	1200CEG	RHP
AEL200	NTN	AEL200	NSK
AELF200	NTN	SF-EC	RHP
AELFC200	NTN	FC-EC	RHP
AELFD200	NTN	AELFD200	NSK
AELFL200	NTN	SFT-EC	RHP
AELP200	NTN	NP-EC	RHP
AELPF200	NTN	SLFE-EC	RHP
AELPF200	NTN	AELPF200	NSK
AELPFL200	NTN	AELPFL200	NSK
AELPL200	NTN	SL-EC	RHP
AELPP200	NTN	LPB-EC	RHP
AELPP200	NTN	AELPP200	NSK
AELPW200	NTN	SNP-EC	RHP
AELRPP200	NTN	LPBR-EC	RHP
AELS200	NTN	1300EC	RHP
AELT200	NTN	ST-EC	RHP
AS200	NTN	1200G	RHP
AS200	NTN	AS200	NSK
ASF200	NTN	SF-A	RHP
ASFC200	NTN	FC-A	RHP
ASFD200	NTN	LFTC-A	RHP
ASFD200	NTN	ASFD200	NSK
ASFL200	NTN	SFT-A	RHP
ASFW200	NTN	LFTC-A	RHP
ASP200	NTN	NP-A	RHP
ASPF200	NTN	SLFE-A	RHP
ASPF200	NTN	ASPF200	NSK
ASPFL200	NTN	ASPFL200	NSK
ASPL200	NTN	SL	RHP
ASPP200	NTN	LPB-A	RHP
ASPP200	NTN	ASPP200	NSK
ASPW200	NTN	SNP-A	RHP
AST200	NTN	ST-A	RHP
CS200LLU	NTN	CS200LLU	RHP
CS-LLU	NTN	1726200-2RS	RHP
UC300	NTN	UC300	NSK
UCF200	NTN	UCF200	NSK
UCF300	NTN	UCF300	NSK
UCFC200	NTN	UCFC200	NSK
UCFC300	NTN	UCFC300	NSK
UCFCX00	NTN	UCFCX00	NSK
UCFH200	NTN	UCFH200	NSK
UCFL200	NTN	UCFL200	NSK
UCFL300	NTN	UCFL300	NSK
UCFLX00	NTN	UCFLX00	NSK
UCFX00	NTN	UCFX00	NSK
UCHB	NTN	SCHB	RHP
UCHB200	NTN	UCHB200	NSK
UCP200	NTN	UCP200	NSK
UCP300	NTN	UCP300	NSK
UCPX00	NTN	UCPX00	NSK
UCS200	NTN	1100	RHP
UCT200	NTN	UCT200	NSK
UCT300	NTN	UCT300	NSK
UCTX00	NTN	UCTX00	NSK
UCUP200	NTN	UCUP200	NSK
UCX00	NTN	UCX00	NSK

Interchange list

Series reference	Manufacturer	RHP and NSK replacement bearing series	
UEL200	NTN	1000DECG	RHP
UEL200	NTN	UEL200	NSK
UELF200	NTN	SF-DEC	RHP
UELF200	NTN	UELF200	NSK
UELFC200	NTN	FC-DEC	RHP
UELFC200	NTN	UELFC200	NSK
UELFL200	NTN	SFT-DEC	RHP
UELFL200	NTN	UELFL200	NSK
UEL2P00	NTN	NP-DEC	RHP
UEL2P00	NTN	UEL2P00	NSK
UELPL200	NTN	SL-DEC	RHP
UELPW200	NTN	SNP-DEC	RHP
UELS200	NTN	1100DEC	RHP
UELT200	NTN	ST-DEC	RHP
UELT200	NTN	UELT200	NSK
UK200	NTN	UK200	NSK
RMS-E	Pollard	MMRJ	RHP
KLNJ	R&M	KLNJ	RHP
KLNJ-D	R&M	KLNJ-Z	RHP
KLNJ-DD	R&M	KLNJ-ZZ	RHP
KLNJ-WSR	R&M	KLNJ-2RS	RHP
630300	RIV	1000G	RHP
5300	Sealmaster	1000G	RHP
5200('C)	Sealmaster	1000G	RHP
5300('C)	Sealmaster	1000G	RHP
MFC	Sealmaster	MFC	RHP
MP	Sealmaster	MP	RHP
MSC	Sealmaster	MSC	RHP
MSF	Sealmaster	MSF	RHP
MSFT	Sealmaster	MSFT	RHP
MST	Sealmaster	MST	RHP
NP	Sealmaster	NP	RHP
SCHB	Sealmaster	SCHB	RHP
SFT	Sealmaster	SFT	RHP
SLG	Sealmaster	SL	RHP
SRP	Sealmaster	LPBR	RHP
SSF	Sealmaster	SLFE	RHP
SSP	Sealmaster	LPB	RHP
ST	Sealmaster	ST	RHP
TB	Sealmaster	CNP	RHP
TB-('C)	Sealmaster	CNP	RHP
SC	Sealmaster	SLC	RHP
SF	Sealmaster	SF	RHP
173200	SKF	1200ECCG	RHP
173600	SKF	1200EC	RHP
174600	SKF	1300EC	RHP
477200	SKF	1000DECG	RHP
479200	SKF	1000G	RHP
1716200D-2LS	SKF	1300EC	RHP
1726200-2RS	SKF	1726200-2RS	RHP
1726200-2RS1	SKF	1726200-2RS	RHP
1726300-2RS1	SKF	1726300-2RS	RHP
238200(D)-2LS	SKF	1200EC	RHP
413200(D)	SKF	1000G	RHP
FY-CB	SKF	SF-EC	RHP
FYC-RM	SKF	FC-A	RHP
FYC-TF	SKF	FC	RHP
FYC-WM	SKF	FC-DEC	RHP
FY-FM	SKF	SF-EC	RHP
FYGF-FJ	SKF	FC-EC	RHP
FYGF-SD	SKF	FC	RHP
FYGF-W	SKF	FC-DEC	RHP
FYJ-FM	SKF	SF-EC	RHP
FYJ-RM	SKF	SF-A	RHP
FYJ-TF	SKF	UCF200	RHP
FYJ-WF	SKF	UELF200	RHP

Series reference	Manufacturer	RHP and NSK replacement bearing series	
FYK..TH/GFA	SKF	PSF-CR	RHP
FY-RM	SKF	SF-A	RHP
FY-S	SKF	SF	RHP
FYTB-CB	SKF	SFT-EC	RHP
FYTB-FJ	SKF	SFT-EC	RHP
FYTB-FM	SKF	SFT-EC	RHP
FYTB-FM	SKF	SFT-EC	RHP
FYTBJ-RM	SKF	SFT-A	RHP
FYTBJ-RM	SKF	SFT-A	RHP
FYTBJ-TF	SKF	UCFL200	RHP
FYTBJ-WF	SKF	UELFL200	RHP
FYTBK..TH/GFA	SKF	PSFT-CR	RHP
FYTB-L(D)	SKF	SFT	RHP
FYTB-RM	SKF	SFT-A	RHP
FYTB-S(D)	SKF	SFT	RHP
FYTB-TF	SKF	SFT	RHP
FYTB-TM	SKF	SFT	RHP
FYTB-W(M)	SKF	SFT-DEC	RHP
FYTB-WF	SKF	SFT-DEC	RHP
FY-TF	SKF	SF	RHP
FYTF-FJ	SKF	LFTC-EC	RHP
FY-TM	SKF	SF	RHP
FY-WM	SKF	SF-DEC	RHP
FY-X	SKF	SF-DEC	RHP
H	SKF	H	RHP
HA	SKF	HA	RHP
HE	SKF	HE	RHP
KM	SKF	AN	RHP
MB	SKF	AW	RHP
P-CA	SKF	LPB-EC	RHP
PF-CA	SKF	SLFE-EC	RHP
PF-FM	SKF	SLFT-DEC	RHP
PF-FM	SKF	SLFT-EC	RHP
PF-FM	SKF	SLFT-A	RHP
PF-FM	SKF	SLFT	RHP
PF-FM	SKF	SLFT	RHP
PF-FM	SKF	SLFT-DEC	RHP
PF-FM	SKF	SLFT-DEC	RHP
PF-FM	SKF	SLFE-EC	RHP
P-FJ	SKF	LPB-EC	RHP
PF-L(D)	SKF	SLFE	RHP
P-FM	SKF	LPB-EC	RHP
PF-PA	SKF	SLFE-EC	RHP
PF-RM	SKF	SLFE-A	RHP
PF-TM	SKF	SLFE-EC	RHP
PF-TF	SKF	SLFE	RHP
PF-TM	SKF	SLFL-EC	RHP
PF-TM	SKF	SLFE	RHP
PF-TM	SKF	SLFL-A	RHP
PFT-FM	SKF	SLFL	RHP
PFT-TF	SKF	SLFL	RHP
PFT-TM	SKF	SLFL	RHP
PFT-W	SKF	SLFL-DEC	RHP
PFT-WF	SKF	SLFL-DEC	RHP
PFT-WM	SKF	SLFL-DEC	RHP
PF-WF	SKF	SLFE-DEC	RHP
PF-WM	SKF	SLFE-DEC	RHP
P-L(D)	SKF	LPB	RHP
P-R-CA	SKF	LPBR-A	RHP
P-R-FA	SKF	LPBR-A	RHP
P-R-FJ	SKF	LPBR-A	RHP
P-R-L	SKF	LPBR	RHP
P-RM	SKF	LPB-A or ASPP200	RHP
P-TF	SKF	LPB	RHP
P-TM	SKF	LPB	RHP
P-W	SKF	LPB-DEC	RHP
P-WF	SKF	LPB-DEC	RHP
P-WM	SKF	LPB-DEC	RHP

Series reference	Manufacturer	RHP and NSK replacement bearing series	
SY	SKF	NP	RHP
SYB-FM	SKF	SL-EC	RHP
SYB-L(D)	SKF	SL	RHP
SYB-TM	SKF	SL	RHP
SYBWM	SKF	SL-DEC	RHP
SY-CB	SKF	NP-EC	RHP
SYF-FM	SKF	SNP-EC	RHP
SYFJ-FM	SKF	SNP-EC	RHP
SYFJ-RM	SKF	SNP-A	RHP
SYFJ-TF	SKF	UCUP200	NSK
SYFJ-WF	SKF	SNP-DEC	RHP
SY-FM	SKF	NP-EC	RHP
SY-FM	SKF	NP-EC	RHP
SYF-RM	SKF	SNP-A	RHP
SYF-TF	SKF	SNP	RHP
SYF-WF	SKF	SNP-DEC	RHP
SYH-CB	SKF	SL-EC	RHP
SYH-X	SKF	SL-DEC	RHP
SYJ-FM	SKF	NP-EC	RHP
SYJ-RM	SKF	NP-A	RHP
SYJ-TF	SKF	UCP200	NSK
SYJ-WF	SKF	UEL200	NSK
SYK...TH/GFA	SKF	PNP-CR	RHP
SY-RM	SKF	NP-A	RHP
SY-TF	SKF	NP	RHP
SY-TM	SKF	NP	RHP
SY-W	SKF	NP-DEC	RHP
SY-WF	SKF	NP-DEC	RHP
SY-WM	SKF	NP-DEC	RHP
TB	SKF	ST	RHP
TB-CB	SKF	ST-EC	RHP
TB-X	SKF	ST-DEC	RHP
TU-FJ	SKF	ST-EC	RHP
TU-FM	SKF	ST-EC	RHP
TU-FM	SKF	ST-EC	RHP
TUJ-FM	SKF	ST-EC	RHP
TUJ-RM	SKF	ST-A	RHP
TUJ-TF	SKF	UCT200	NSK
TUJ-WF	SKF	UEL200	NSK
TU-L(D)	SKF	ST	RHP
TU-RM	SKF	ST-A	RHP
TU-S(D)	SKF	ST	RHP
TU-TF	SKF	ST	RHP
TU-TM	SKF	ST	RHP
TU-WF	SKF	ST-DEC	RHP
TU-WM	SKF	ST-DEC	RHP
YAR2...2RF/ HVGFA	SKF	J1000GCR	RHP
YAR200	SKF	1000G	RHP
YAR-2-2RF	SKF	1000GFS	RHP
YAR-2F	SKF	1000G	RHP
YAT200	SKF	1200G	RHP
YEL200	SKF	1000DECG	RHP
YEL200-2F	SKF	1000DECG	RHP
YET200	SKF	1200ECG	RHP
YSA200-2FK	SKF	1000KG	RHP
CES200	SNR	1300EC	RHP
CEX200	SNR	1100DEC	RHP
CUC200	SNR	1100	RHP
CUCS200	SNR	1300	RHP
ES200	SNR	1200ECG	RHP
ESC200	SNR	SLC-EC	RHP
ESEHE200	SNR	SCH-EC	RHP
ESF200	SNR	SF-EC	RHP
ESFC200	SNR	FC-EC	RHP
ESFD	SNR	LFTC-EC	RHP

Series reference	Manufacturer	RHP and NSK replacement bearing series	
ESFL200	SNR	SFT-EC	RHP
ESP200	SNR	NP-EC	RHP
ESPA200	SNR	SNP-EC	RHP
ESSP200	SNR	BT-EC	RHP
EST200	SNR	ST-EC	RHP
EX200	SNR	1000DECG	RHP
EX200L3	SNR	T1000DECG8	RHP
EXC200	SNR	SLC-DEC	RHP
EXHE200	SNR	SCH-DEC	RHP
EXF200	SNR	SF-DEC	RHP
EXFC200	SNR	FC-DEC	RHP
EXP200	SNR	NP-DEC	RHP
EXPA200	SNR	SNP-DEC	RHP
EXSP200	SNR	BT-DEC	RHP
EXT200	SNR	ST-DEC	RHP
GNP	SNR	PNP-CR	RHP
GSF	SNR	PSF-CR	RHP
GSFT	SNR	PSFT-CR	RHP
MUC...FD	SNR	J1000GCR	RHP
SPR	SNR	BTHF	RHP
UC200	SNR	1000G	RHP
UC200L3	SNR	T1000G	RHP
UCC200	SNR	SLC	RHP
UCHE200	SNR	SCH	RHP
UCF200	SNR	SF	RHP
UCFC200	SNR	FC	RHP
UCFL200	SNR	SFT	RHP
UCP200	SNR	NP	RHP
UCPA200	SNR	SNP	RHP
UCSP200	SNR	BT	RHP
UCT200	SNR	ST	RHP
UK200	SNR	1000KG	RHP
UKC200	SNR	SLC1000K	RHP
UKEHE200	SNR	SCH1000K	RHP
UKF200	SNR	SF1000K	RHP
UKFL200	SNR	SFT1000K	RHP
UKP200	SNR	NP1000K	RHP
UKPA200	SNR	SNP1000K	RHP
UKT200	SNR	ST1000K	RHP
US200	SNR	1200G	RHP
USC200	SNR	SLC-A	RHP
USEHE200	SNR	SCH-A	RHP
USF200	SNR	SF-A	RHP
USFC200	SNR	FC-A	RHP
USFD	SNR	LFTC-A	RHP
USFL200	SNR	SFT-A	RHP
USP200	SNR	NP-A	RHP
USPA200	SNR	SNP-A	RHP
USSP200	SNR	BT-A	RHP
UST200	SNR	ST-A	RHP
6200EES	Steyr	176200-2RS	RHP



Conversion tables



Conversion Tables

Comparison of SI, CGS and engineering units

Units Unit system	Length	Mass	Time	Temp.	Acceleration	Force	Stress	Pressure	Energy	Power
SI	m	kg	s	K, °C	m/s ²	N	Pa	Pa	J	W
CGS System	cm	g	s	°C	Gal	dyn	dyn/cm ²	dyn/cm ²	erg	erg/s
Engineering unit system	m	kgf · s ² /m	s	°C	m/s ²	kgf	kgf/m ²	kgf/m ²	kgf · m	kgf · m/s

Conversion factors from SI units

Parameter	SI Unit		Unit other than SI		Conversion factor from SI unit
	Names of unit	Symbol	Name of unit	Symbol	
Angle	Radian	rad	Degree	°	180/π
			Minute	'	10 800/π
			Second	"	648 000/π
Length	Metre	m	Micron	μ	10 ⁶
			Angstrom	Å	10 ¹⁰
Area	Square metre	m ²	Are	a	10 ²
			Hectare	ha	10 ⁴
Volume	Cubic metre	m ³	Litre	l, L	10 ³
			Decilitre	dl, dL	10 ⁴
Time	Second	s	Minute	min	1/60
			Hour	h	1/3 600
			Day	d	1/86 400
Frequency	Hertz	Hz	Cycle	s ⁻¹	1
Speed of Rotation	Revolution per second	s ⁻¹	Revolution per minute	rpm	60
Speed	Metre per second	m/s	Kilometre per hour	km/h	3 600/1 000
			Knot	kn	3 600/1 852
Acceleration	Metre per second per second	m/s ²	Gravitational acceleration	G	1/9.806 65
Mass	Kilogram	kg	Tonne	te	10 ³
			Ton	t	9.842 x 10 ⁻⁴
Force	Newton	N	Kilogram-force	kgf	1/9.806 65
			Ton-force	tf	1/(9.806 65 · 103)
			Dyne	dyn	10 ⁵
Torque or Moment	Newton · metre	N · m	Kilogram-force metre	kgf · m	1/9.806 65
Stress	Pascal	Pa (N/m ²)	Kilogram-force per square centimetre	kgf/cm ²	1/(9.806 65 · 10 ⁻⁴)
			Kilogram-force per square millimetre	kgf/mm ²	1/(9.806 65 · 10 ⁶)
Pressure	Pascal (Newton per square metre)	Pa (N/m ²)	Kilogram-force per square metre	kgf/m ²	1/9.806 65
			Water Column	mH ₂ O	1/(9.806 65 · 10 ³)
			Mercury Column	mmHg	760/(1.013 25 · 10 ⁵)
			Torr	Torr	760/(1.013 25 · 10 ⁵)
			Bar	bar	10 ⁵
Atmosphere	atm	1/(1.013 25 · 10 ⁵)			

Conversion factors from SI units (continued)

Parameter	SI Unit		Unit other than SI		Conversion factor from SI unit
	Names of unit	Symbol	Name of unit	Symbol	
Energy	Joule (Newton · metre)	J (N · m)	Erg	erg	107
			Calorie (International)	cal _{IT}	4.186 8
			Kilogram-force metre	kgf · m	1/9.806 65
			Kilowatt hour	kW · h	1/(3.6 · 10 ⁶)
			Metric horse power hour	PS · h	≈ 3.776 72 · 10 ⁷
Power	Watt (joule per second)	W (J/s)	Kilogram-force metre per second	kgf · m/s	1/9.806 65
			Kilocalorie per hour	kcal/h	1/1.163
			Metric horse power	PS	≈ 1/735.498 8
Dynamic Viscosity	Pascal second	Pa · s	Poise	P	10
Kinematic Viscosity	Square metre per second	m²/s	Stokes	St	10 ⁴
			Centistokes	cSt	10 ⁶
Temperature	Kelvin, Degree celsius	K, °C	Degree	°C	(See note (1))
Electric Current	Ampere	A	Ampere	A	1
Magnetomotive Force					
Voltage, Electromotive Force	Volt	V	(Watts per ampere)	(W/A)	1
Magnetic Field Strength	Ampere per metre	A/m	Oersted	Oe	4π/10 ³
Magnetic Flux Density	Tesla	T	Gauss	Gs	10 ⁴
			Gamma	γ	10 ⁹
Electrical Resistance	Ohm	Ω	(Volts per ampere)	(V/A)	1

Note (1) The conversion from T(K) into θ(°C) is θ = T - 273.15 but for a temperature difference, it is ΔT = Δθ. However, ΔT and Δθ represent temperature differences measured using the Kelvin and Celsius scales respectively.

Remarks The names and symbols in () are equivalent to those directly above them or on their left.

Example of conversion 1N=1/9.806 65kgf

Prefixes used in SI system

Multiples	Prefix	Symbols	Multiples	Prefix	Symbols
10 ¹⁸	Exa	E	10 ⁻¹	Deci	d
10 ¹⁵	Peta	P	10 ⁻²	Centi	c
10 ¹²	Tera	T	10 ⁻³	Milli	m
10 ⁹	Giga	G	10 ⁻⁶	Micro	μ
10 ⁶	Mega	M	10 ⁻⁹	Nano	n
10 ³	Kilo	k	10 ⁻¹²	Pico	p
10 ²	Hecto	h	10 ⁻¹⁵	Femto	f
10 ¹	Deca	da	10 ⁻¹⁸	Atto	a

Inch - Metric conversion tables

Inch		0	1	2	3	4	5	6	7	8	9	10
Fraction	Decimal	mm										
0	0.00000	0.000	25.400	50.800	76.200	101.600	127.000	152.400	177.800	203.200	228.600	254.000
1/4	0.015625	0.397	25.797	51.197	76.597	101.997	127.397	152.797	178.197	203.597	228.997	254.397
3/32	0.031250	0.794	26.194	51.594	76.994	102.394	127.794	153.194	178.594	203.994	229.394	254.794
3/64	0.046875	1.191	26.591	51.991	77.391	102.791	128.191	153.591	178.991	204.391	229.791	255.191
1/16	0.062500	1.588	26.988	52.388	77.788	103.188	128.588	153.988	179.388	204.788	230.188	255.588
5/64	0.078125	1.984	27.384	52.784	78.184	103.584	128.984	154.384	179.784	205.184	230.584	255.984
3/32	0.093750	2.381	27.781	53.181	78.581	103.981	129.381	154.781	180.181	205.581	230.981	256.381
7/64	0.109375	2.778	28.178	53.578	78.978	104.378	129.778	155.178	180.578	205.978	231.378	256.778
1/8	0.125000	3.175	28.575	53.975	79.375	104.775	130.175	155.575	180.975	206.375	231.775	257.175
9/64	0.140625	3.572	28.972	54.372	79.772	105.172	130.572	155.972	181.372	206.772	232.172	257.572
5/32	0.156250	3.969	29.369	54.769	80.169	105.569	130.969	156.369	181.769	207.169	232.569	257.969
11/64	0.171875	4.366	29.766	55.166	80.566	105.966	131.366	156.766	182.166	207.566	232.966	258.366
3/16	0.187500	4.762	30.162	55.562	80.962	106.362	131.762	157.162	182.562	207.962	233.362	258.762
13/64	0.203125	5.159	30.559	55.959	81.359	106.759	132.159	157.559	182.959	208.359	233.759	259.159
7/32	0.218750	5.556	30.956	56.356	81.756	107.156	132.556	157.956	183.356	208.756	234.156	259.556
15/64	0.234375	5.953	31.353	56.753	82.153	107.553	132.953	158.353	183.753	209.153	234.553	259.953
1/4	0.250000	6.350	31.750	57.150	82.550	107.950	133.350	158.750	184.150	209.550	234.950	260.350
17/64	0.265625	6.747	32.147	57.547	82.947	108.347	133.747	159.147	184.547	209.947	235.347	260.747
9/32	0.281250	7.144	32.544	57.944	83.344	108.744	134.144	159.544	184.944	210.344	235.744	261.144
19/64	0.296875	7.541	32.941	58.341	83.741	109.141	134.541	159.941	185.341	210.741	236.141	261.541
5/16	0.312500	7.938	33.338	58.738	84.138	109.538	134.938	160.338	185.738	211.138	236.538	261.938
21/64	0.328125	8.334	33.734	59.134	84.534	109.934	135.334	160.734	186.134	211.534	236.934	262.334
11/32	0.343750	8.731	34.131	59.531	84.931	110.331	135.731	161.131	186.531	211.931	237.331	262.731
23/64	0.359375	9.128	34.528	59.928	85.328	110.728	136.128	161.528	186.928	212.328	237.728	263.128
3/8	0.375000	9.525	34.925	60.325	85.725	111.125	136.525	161.925	187.325	212.725	238.125	263.525
25/64	0.390625	9.922	35.322	60.722	86.122	111.522	136.922	162.322	187.722	213.122	238.522	263.922
13/32	0.406250	10.319	35.719	61.119	86.519	111.919	137.319	162.719	188.119	213.519	238.919	264.319
27/64	0.421875	10.716	36.116	61.516	86.916	112.316	137.716	163.116	188.516	213.916	239.316	264.716
7/16	0.437500	11.112	36.512	61.912	87.312	112.712	138.112	163.512	188.912	214.312	239.712	265.112
29/64	0.453125	11.509	36.909	62.309	87.709	113.109	138.509	163.909	189.309	214.709	240.109	265.509
15/32	0.468750	11.906	37.306	62.706	88.106	113.506	138.906	164.306	189.706	215.106	240.506	265.906
31/64	0.484375	12.303	37.703	63.103	88.503	113.903	139.303	164.703	190.103	215.503	240.903	266.303
1/2	0.500000	12.700	38.100	63.500	88.900	114.300	139.700	165.100	190.500	215.900	241.300	266.700
33/64	0.515625	13.097	38.497	63.897	89.297	114.697	140.097	165.497	190.897	216.297	241.697	267.097
17/32	0.531250	13.494	38.894	64.294	89.694	115.094	140.494	165.894	191.294	216.694	242.094	267.494
35/64	0.546875	13.891	39.291	64.691	90.091	115.491	140.891	166.291	191.691	217.091	242.491	267.891
9/16	0.562500	14.288	39.688	65.088	90.488	115.888	141.288	166.688	192.088	217.488	242.888	268.288
37/64	0.578125	14.684	40.084	65.484	90.884	116.284	141.684	167.084	192.484	217.884	243.284	268.684
19/32	0.593750	15.081	40.481	65.881	91.281	116.681	142.081	167.481	192.881	218.281	243.681	269.081
39/64	0.609375	15.478	40.878	66.278	91.678	117.078	142.478	167.878	193.278	218.678	244.078	269.478
5/8	0.625000	15.875	41.275	66.675	92.075	117.475	142.875	168.275	193.675	219.075	244.475	269.875
41/64	0.640625	16.272	41.672	67.072	92.472	117.872	143.272	168.672	194.072	219.472	244.872	270.272
21/32	0.656250	16.669	42.069	67.469	92.869	118.269	143.669	169.069	194.469	219.869	245.269	270.669
43/64	0.671875	17.066	42.466	67.866	93.266	118.666	144.066	169.466	194.866	220.266	245.666	271.066
11/16	0.687500	17.462	42.862	68.262	93.662	119.062	144.462	169.862	195.262	220.662	246.062	271.462
45/64	0.703125	17.859	43.259	68.659	94.059	119.459	144.859	170.259	195.659	221.059	246.459	271.859
23/32	0.718750	18.256	43.656	69.056	94.456	119.856	145.256	170.656	196.056	221.456	246.856	272.256
47/64	0.734375	18.653	44.053	69.453	94.853	120.253	145.653	171.053	196.453	221.853	247.253	272.653
3/4	0.750000	19.050	44.450	69.850	95.250	120.650	146.050	171.450	196.850	222.250	247.650	273.050
49/64	0.765625	19.447	44.847	70.247	95.647	121.047	146.447	171.847	197.247	222.647	248.047	273.447
25/32	0.781250	19.844	45.244	70.644	96.044	121.444	146.844	172.244	197.644	223.044	248.444	273.844
51/64	0.796875	20.241	45.641	71.041	96.441	121.841	147.241	172.641	198.041	223.441	248.841	274.241
13/16	0.812500	20.638	46.038	71.438	96.838	122.238	147.638	173.038	198.438	223.838	249.238	274.638
53/64	0.828125	21.034	46.434	71.834	97.234	122.634	148.034	173.434	198.834	224.234	249.634	275.034
27/32	0.843750	21.431	46.831	72.231	97.631	123.031	148.431	173.831	199.231	224.631	250.031	275.431
55/64	0.859375	21.828	47.228	72.628	98.028	123.428	148.828	174.228	199.628	225.028	250.428	275.828
7/8	0.875000	22.225	47.625	73.025	98.425	123.825	149.225	174.625	200.025	225.425	250.825	276.225
57/64	0.890625	22.622	48.022	73.422	98.822	124.222	149.622	175.022	200.422	225.822	251.222	276.622
29/32	0.906250	23.019	48.419	73.819	99.219	124.619	150.019	175.419	200.819	226.219	251.619	277.019
59/64	0.921875	23.416	48.816	74.216	99.616	125.016	150.416	175.816	201.216	226.616	252.016	277.416
15/16	0.937500	23.812	49.212	74.612	100.012	125.412	150.812	176.212	201.612	227.012	252.412	277.812
61/64	0.953125	24.209	49.609	75.009	100.409	125.809	151.209	176.609	202.009	227.409	252.809	278.209
31/32	0.968750	24.606	50.006	75.406	100.806	126.206	151.606	177.006	202.406	227.806	253.206	278.606
63/64	0.984375	25.003	50.403	75.803	101.203	126.603	152.003	177.403	202.803	228.203	253.603	279.003

Inch		11	12	13	14	15	16	17	18	19	20
Fraction	Decimal	mm									
0	0.0000	279.400	304.800	330.200	355.600	381.000	406.400	431.800	457.200	482.600	508.000
1/16	0.0625	280.988	306.388	331.788	357.188	382.588	407.988	433.388	458.788	484.188	509.588
1/8	0.1250	282.575	307.975	333.375	358.775	384.175	409.575	434.975	460.375	485.775	511.175
3/16	0.1875	284.162	309.562	334.962	360.362	385.762	411.162	436.562	461.962	487.362	512.762
1/4	0.2500	285.750	311.150	336.550	361.950	387.350	412.750	438.150	463.550	488.950	514.350
5/16	0.3125	287.338	312.738	338.138	363.538	388.938	414.338	439.738	465.138	490.538	515.938
3/8	0.3750	288.925	314.325	339.725	365.125	390.525	415.925	441.325	466.725	492.125	517.525
7/16	0.4375	290.512	315.912	341.312	366.712	392.112	417.512	442.912	468.312	493.712	519.112
1/2	0.5000	292.100	317.500	342.900	368.300	393.700	419.100	444.500	469.900	495.300	520.700
9/16	0.5625	293.688	319.088	344.488	369.888	395.288	420.688	446.088	471.488	496.888	522.288
5/8	0.6250	295.275	320.675	346.075	371.475	396.875	422.275	447.675	473.075	498.475	523.875
11/16	0.6875	296.862	322.262	347.662	373.062	398.462	423.862	449.262	474.662	500.062	525.462
3/4	0.7500	298.450	323.850	349.250	374.650	400.050	425.450	450.850	476.250	501.650	527.050
13/16	0.8125	300.038	325.438	350.838	376.238	401.638	427.038	452.438	477.838	503.238	528.638
7/8	0.8750	301.625	327.025	352.425	377.825	403.225	428.625	454.025	479.425	504.825	530.225
15/16	0.9375	303.212	328.612	354.012	379.412	404.812	430.212	455.612	481.012	506.412	531.812

Inch		21	22	23	24	25	26	27	28	29	30
Fraction	Decimal	mm									
0	0.0000	533.400	558.800	584.200	609.600	635.000	660.400	685.800	711.200	736.600	762.000
1/16	0.0625	534.988	560.388	585.788	611.188	636.588	661.988	687.388	712.788	738.188	763.588
1/8	0.1250	536.575	561.975	587.375	612.775	638.175	663.575	688.975	714.375	739.775	765.175
3/16	0.1875	538.162	563.562	588.962	614.362	639.762	665.162	690.562	715.962	741.362	766.762
1/4	0.2500	539.750	565.150	590.550	615.950	641.350	666.750	692.150	717.550	742.950	768.350
5/16	0.3125	541.338	566.738	592.138	617.538	642.938	668.338	693.738	719.138	744.538	769.938
3/8	0.3750	542.925	568.325	593.725	619.125	644.525	669.925	695.325	720.725	746.125	771.525
7/16	0.4375	544.512	569.912	595.312	620.712	646.112	671.512	696.912	722.312	747.712	773.112
1/2	0.5000	546.100	571.500	596.900	622.300	647.700	673.100	698.500	723.900	749.300	774.700
9/16	0.5625	547.688	573.088	598.488	623.888	649.288	674.688	700.088	725.488	750.888	776.288
5/8	0.6250	549.275	574.675	600.075	625.475	650.875	676.275	701.675	727.075	752.475	777.875
11/16	0.6875	550.862	576.262	601.662	627.062	652.462	677.862	703.262	728.662	754.062	779.462
3/4	0.7500	552.450	577.850	603.250	628.650	654.050	679.450	704.850	730.250	755.650	781.050
13/16	0.8125	554.038	579.438	604.838	630.238	655.638	681.038	706.438	731.838	757.238	782.638
7/8	0.8750	555.625	581.025	606.425	631.825	657.225	682.625	708.025	733.425	758.825	784.225
15/16	0.9375	557.212	582.612	608.012	633.412	658.812	684.212	709.612	735.012	760.412	785.812

Inch		31	32	33	34	35	36	37	38	39	40
Fraction	Decimal	mm									
0	0.0000	787.400	812.800	838.200	863.600	889.000	914.400	939.800	965.200	990.600	1016.000
1/16	0.0625	788.988	814.388	839.788	865.188	890.588	915.988	941.388	966.788	992.188	1017.588
1/8	0.1250	790.575	815.975	841.375	866.775	892.175	917.575	942.975	968.375	993.775	1019.175
3/16	0.1875	792.162	817.562	842.962	868.362	893.762	919.162	944.562	969.962	995.362	1020.762
1/4	0.2500	793.750	819.150	844.550	869.950	895.350	920.750	946.150	971.550	996.950	1022.350
5/16	0.3125	795.338	820.738	846.138	871.538	896.938	922.338	947.738	973.138	998.538	1023.938
3/8	0.3750	796.925	822.325	847.725	873.125	898.525	923.925	949.325	974.725	1000.125	1025.525
7/16	0.4375	798.512	823.912	849.312	874.712	900.112	925.512	950.912	976.312	1001.712	1027.112
1/2	0.5000	800.100	825.500	850.900	876.300	901.700	927.100	952.500	977.900	1003.300	1028.700
9/16	0.5625	801.688	827.088	852.488	877.888	903.288	928.688	954.088	979.488	1004.888	1030.288
5/8	0.6250	803.275	828.675	854.075	879.475	904.875	930.275	955.675	981.075	1006.475	1031.875
11/16	0.6875	804.862	830.262	855.662	881.062	906.462	931.862	957.262	982.662	1008.062	1033.462
3/4	0.7500	806.450	831.850	857.250	882.650	908.050	933.450	958.850	984.250	1009.650	1035.050
13/16	0.8125	808.038	833.438	858.838	884.238	909.638	935.038	960.438	985.838	1011.238	1036.638
7/8	0.8750	809.625	835.025	860.425	885.825	911.225	936.625	962.025	987.425	1012.825	1038.225
15/16	0.9375	811.212	836.612	862.012	887.412	912.812	938.212	963.612	989.012	1014.412	1039.812

Temperature conversion tables

Appendix table 4 °C-°F conversion table

(Method of using this table) For example, to convert 38°C into °F, read the figure in the right °F column adjacent to the 38 in the center column in the 2nd block. This means that 38°C is 100.4°F. To convert 38°F into°C, read the figure in the left °C column of the same row, which indicates that the answer is 3.3°C.

$$C = \frac{5}{9} (F-32)$$

$$F = 32 + \frac{5}{9} C$$

°C		°F
-73.3	-100	-148.0
-62.2	-80	-112.0
-51.1	-60	-76.0
-40.0	-40	-40.0
-34.4	-30	-22.0
-28.9	-20	-4.0
-23.3	-10	14.0
-17.8	0	32.0
-17.2	1	33.8
-16.7	2	35.6
-16.1	3	37.4
-15.6	4	39.2
-15.0	5	41.0
-14.4	6	42.8
-13.9	7	44.6
-13.3	8	46.4
-12.8	9	48.2
-12.2	10	50.0
-11.7	11	51.8
-11.1	12	53.6
-10.6	13	55.4
-10.0	14	57.2
-9.4	15	59.0
-8.9	16	60.8
-8.3	17	62.6
-7.8	18	64.4
-7.2	19	66.2
-6.7	20	68.0
-6.1	21	69.8
-5.6	22	71.6
-5.0	23	73.4
-4.4	24	75.2
-3.9	25	77.0
-3.3	26	78.8
-2.8	27	80.6
-2.2	28	82.4
-1.7	29	84.2
-1.1	30	86.0
-0.6	31	87.8

°C		°F
0.0	32	89.6
0.6	33	91.4
1.1	34	93.2
1.7	35	95.0
2.2	36	96.8
2.8	37	98.6
3.3	38	100.4
3.9	39	102.2
4.4	40	104.0
5.0	41	105.8
5.6	42	107.6
6.1	43	109.4
6.7	44	111.2
7.2	45	113.0
7.8	46	114.8
8.3	47	116.6
8.9	48	118.4
9.4	49	120.2
10.0	50	122.0
10.6	51	123.8
11.1	52	125.6
11.7	53	127.4
12.2	54	129.2
12.8	55	131.0
13.3	56	132.8
13.9	57	134.6
14.4	58	136.4
15.0	59	138.2
15.6	60	140.0
16.1	61	141.8
16.7	62	143.6
17.2	63	145.4
17.8	64	147.2
18.3	65	149.0
18.9	66	150.8
19.4	67	152.6
20.0	68	154.4
20.6	69	156.2
21.1	70	158.0

°C		°F
21.7	71	159.8
22.2	72	161.6
22.8	73	163.4
23.3	74	165.2
23.9	75	167.0
24.4	76	168.8
25.0	77	170.6
25.6	78	172.4
26.1	79	174.2
26.7	80	176.0
27.2	81	177.8
27.8	82	179.6
28.3	83	181.4
28.9	84	183.2
29.4	85	185.0
30.0	86	186.8
30.6	87	188.6
31.1	88	190.4
31.7	89	192.2
32.2	90	194.0
32.8	91	195.8
33.3	92	197.6
33.9	93	199.4
34.4	94	201.2
35.0	95	203.0
35.6	96	204.8
36.1	97	206.6
36.7	98	208.4
37.2	99	210.2
37.8	100	212.0
38.3	101	213.8
38.9	102	215.6
39.4	103	217.4
40.0	104	219.2
40.6	105	221.0
41.1	106	222.8
41.7	107	224.6
42.2	108	226.4
42.8	109	228.2

°C		°F
43.3	110	230
46.1	115	239
48.9	120	248
51.7	125	257
54.4	130	266
57.2	135	275
60.0	140	284
65.6	150	302
71.1	160	320
76.7	170	338
82.2	180	356
87.8	190	374
93.3	200	392
98.9	210	410
104.4	220	428
110.0	230	446
115.6	240	464
121.1	250	482
148.9	300	572
176.7	350	662
204	400	752
232	450	842
260	500	932
288	550	1022
316	600	1112
343	650	1202
371	700	1292
399	750	1382
427	800	1472
454	850	1562
482	900	1652
510	950	1742
538	1000	1832
593	1100	2012
649	1200	2192
704	1300	2372
760	1400	2552
816	1500	2732
871	1600	2912

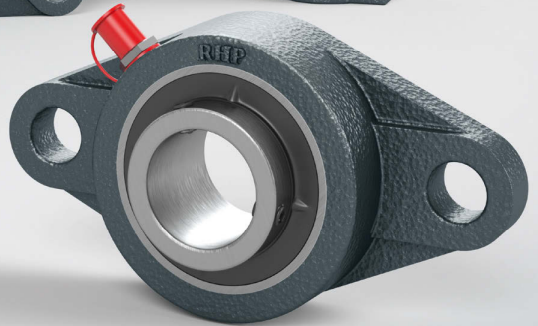
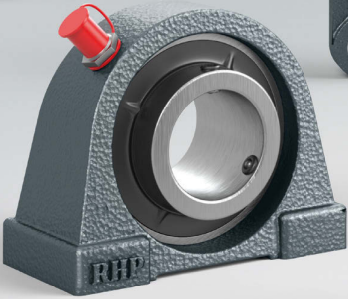

J-Line Bearing Units

Contents

J-Line Range

I. Technical Data

- | | |
|--|------------|
| 1. Structure of J-Line Bearing Units | 157 |
| 2. Design Features and Advantages | |
| 2.1 Combination table | 158 |
| 2.2 Sealing | 160 |
| 2.3 Secure fitting | 161 |
| 2.4 Self-aligning | 161 |
| 2.5 Easy mounting | 161 |
| 2.6 Bearing replaceability | 161 |
| 2.7 Fit of insert in housing | 161 |
| 3. Tolerances | |
| 3.1 Radial internal clearance of insert bearings | 162 |
| 3.2 Dimensional tolerances of insert bearings | 163 |
| 3.3 Dimensional tolerances of housings | 164 |
| 4. Load Rating and Life | |
| 4.1 Bearing life | 167 |
| 4.2 Selection of ball bearing units | 171 |
| 4.3 Selection of shafts | 172 |
| 4.4 Limiting speed | 174 |
| 5. Lubrication | |
| 5.1 Permissible speed | 175 |
| 5.2 Type of grease nipple | 175 |
| 5.3 Location of grease nipple | 175 |
| 5.4 Lubricant grease | 176 |
| 5.5 Replenishment of grease | 176 |
| 6. Mounting instructions for J-Line Bearing Units | 178 |

II. Dimension Tables

181



I. Technical Data

1. Structure of J-Line Bearing Units

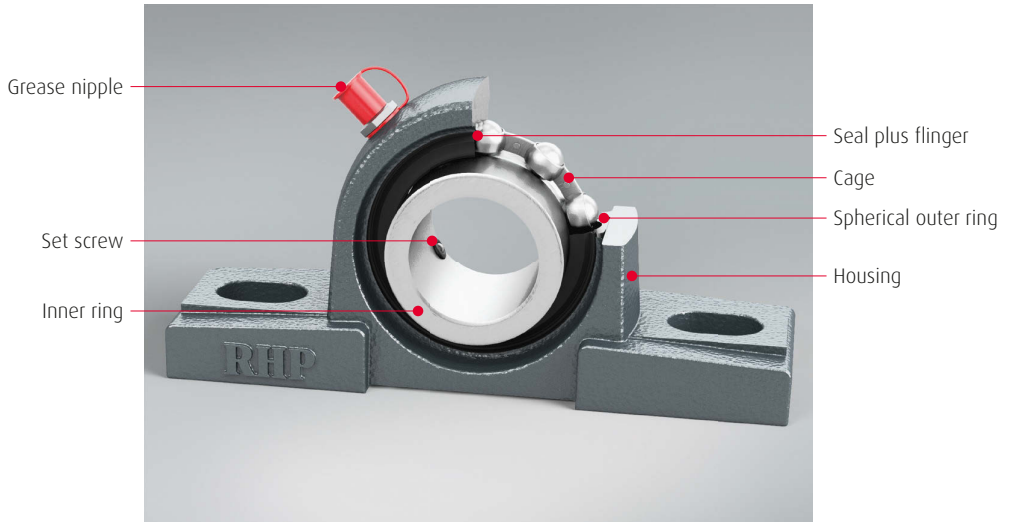

2. Design Features and Advantages

2.1 Combination table

Housing

Insert type

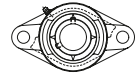
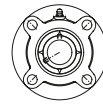
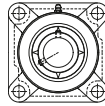
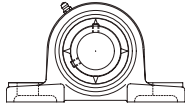

Set screw

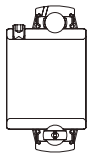

UC2

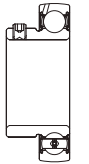

AS2

Eccentric locking collar

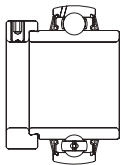

UEL2

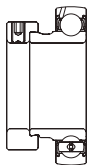

AEL2

Adapter

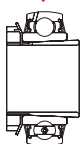

UK2

	Page	Page	Page	Page			
UCP2	184	UCF2	190	UCFC2	196	UCFL2	202
UEL2	186	UELF2	192	UELFC2	198	UELFL2	204
UKP2	188	UKF2	194	UKFC2	200	UKFL2	206

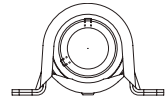
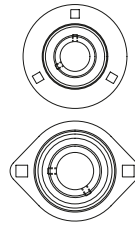
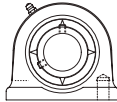
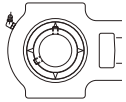

	Page		Page		Page		Page
UCT2	208	UCUP2	214				
				ASPF2	238	ASPP2	230
				ASPFL2	234		
UFLT2	210	UELUP2	216				
				AELPF2	240	AELPP2	232
				AELPFL2	236		
UKT2	212	UKUP2	218				

2. Design Features and Advantages

2.2 Sealing

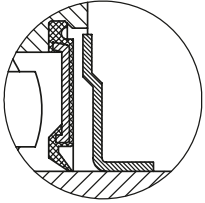

SL type (standard):
dual seal

The rubber seal is fixed in a groove in the bore on the inside diameter of the outer ring and the lip contacts the outside diameter of the inner ring. The separate metal flinger is fixed on the outside diameter of the inner ring, leaving a small annular gap to the bore diameter of the outer ring. This configuration provides a very effective labyrinth which prevents contamination from entering the inside of the bearing. (Standard for UC, UEL and UK series)

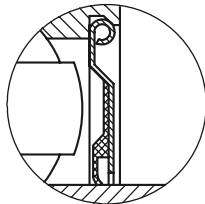

H type:
metal seal

The rubber seal is bonded to a steel plate that is fixed in a groove in the bore diameter of the outer ring. The rubber seal contacts on the outside diameter of the inner ring, and the steel plate also has a small annular gap to the outside diameter of the inner ring. This configuration provides a robust and effective barrier to prevent contamination from entering the inside of the bearing. (Standard for AS and AEL series)

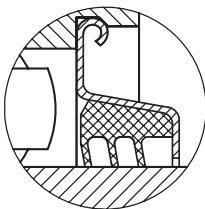

L3 type:
triple lip seal

A rubber seal with 3 lips is bonded to a steel plate that is fixed in a groove on the bore diameter of the outer ring. The 3 lips of the rubber seal contact on the outside diameter of the inner ring and the steel plate also has a small annular gap to the outside diameter of the inner ring. This configuration provides very effective protection in applications with high levels of contamination. (Optional for UC and UEL series – available upon request)

2.3 Secure fitting

Fastening the bearing to the shaft is effected by tightening the set screw, situated on the inner ring. This is a unique feature which prevents loosening, even if the bearing is subjected to intense vibrations and shocks.

2.4 Self-aligning

With the J-Line bearing unit, the outer diameter of the bearing and the inner diameter of the housing are spherical, giving the unit self-aligning characteristics to accommodate any initial misalignment of the shaft.

2.5 Easy mounting

The J-Line bearing unit is an integrated unit consisting of a bearing insert and a housing. As the bearing is prelubricated with a high-grade lithium base grease during manufacture, it can be mounted on the shaft directly, no additional lubrication is required when mounting.

2.6 Bearing replaceability

The bearing insert used in the J-Line bearing unit can easily be replaced with a similar product. In the event of insert failure, a new bearing can be fitted into the existing housing.

2.7 Fit of insert in housing

To securely locate the bearing insert in the housing, J-Line uses a "J-Fit" dimensional interference between the bearing outside diameter and the bore of the housing, as standard.

In addition, a pin stop has been added to the UC, UEL and UK series inserts as an additional safety feature to the interference fit. The pin stop prevents rotation of the outer ring, even if the bearing swivels inside the housing during use.

3. Tolerances

3.1 Radial internal clearance of insert bearings

C3 for cylindrical bore bearings and C4 for tapered bore bearings.

3.1.1 Cylindrical bore insert bearings

Bore diameter d (mm)		C3	
over	incl.	min.	max.
10	18	11	25
18	24	13	28
24	30	13	28
30	40	15	33
40	50	18	36
50	65	23	43
65	80	25	51
80	100	30	58
100	120	36	66
120	140	41	81

Unit = 0.001 mm

3.1.2 Tapered bore insert bearings

Bore diameter d (mm)		C4	
over	incl.	min.	max.
10	18	18	33
18	24	20	36
24	30	23	41
30	40	28	46
40	50	30	51
50	65	38	61
65	80	46	71
80	100	53	84
100	120	61	97
120	140	71	114

Unit = 0.001 mm

3.2 Dimensional tolerances of insert bearings

3.2.1 Tolerances of outer ring

D (mm)		Δ_{dmp}		K_{ea}
over	incl.	high	low	max.
30	50	0	-11	20
50	80	0	-13	25
80	120	0	-15	35
120	150	0	-18	40
150	180	0	-25	45
180	250	0	-30	50
250	315	0	-35	60

Unit = 0.001 mm

D Brg. outside dia., nominal
 Δ_{dmp} Single plane mean bore dia. deviation
 K_{ea} Radial runout of assembled brg. outer ring

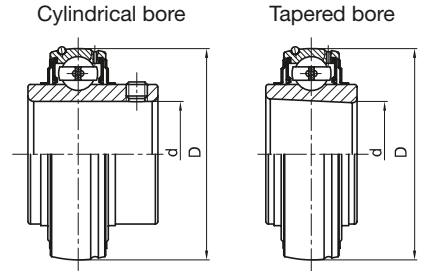

3.2.2 Tolerances of inner ring with cylindrical bore

d (mm)		Cylindrical bore insert bearing						K_{ia}
		Bore diameter			Δ_{Bs}, Δ_{Cs}			
		Δ_{dmp}	V_{dp}	high	low	high	low	
over	incl.	high	low	max.	high	low	max.	
10	18	+15	0	10	0	-120	15	
18	30	+18	0	12	0	-120	18	
30	50	+21	0	14	0	-120	20	
50	80	+24	0	16	0	-150	25	
80	120	+28	0	19	0	-200	30	
120	180	+33	0	22	0	-250	35	

d Brg. bore dia., nominal
 Δ_{dmp} Single plane mean outside dia. Deviation
 V_{dp} Bore dia. Variation in a single radial plane
 Δ_{Bs} Deviation of a single inner ring width
 Δ_{Cs} Deviation of a single outer ring width
 K_{ia} Radial runout of assembles brg. inner ring

3. Tolerances

3.2.3 Tolerances of inner ring with tapered bore

d (mm)		Δ_{dmp}		$\Delta_{d1mp} - \Delta_{dmp}$		$V_{dp}^{1)}$
over	incl.	max.	min.	max.	min.	max.
18	30	+33	0	+21	0	13
30	50	+39	0	+25	0	15
50	80	+46	0	+30	0	19
80	120	+54	0	+35	0	25
120	180	+63	0	+40	0	31

Unit = 0.001 mm

- 1) Applies to any single radial plane of the bore
- d Brg. bore dia., nominal
- d_1 Theoretical diameter of large end of a basically tapered bore $d_1 = d + \frac{1}{2}B$
- Δ_{dmp} Single plane mean bore dia. deviation
- Δ_{d1mp} Deviation of mean bore diameter in a single plane at the theoretical diameter of the small end of a basically tapered bore
- V_{dp} Bore dia. Variation in a single radial plane
- B Inner ring width, nominal
- α The taper angle (half the cone angle) is $\alpha = 2^\circ 23' 9.4''$
 $= 2.38594^\circ$
 $= 0.041643 \text{ rad}$

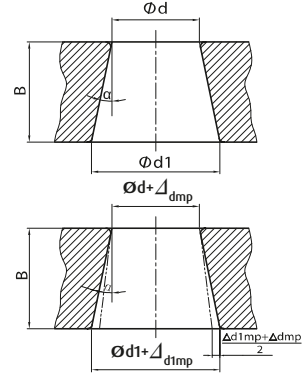

3.3 Dimensional tolerances of housings

The spherical bore diameter of the J-Line housing follows the J7 tolerance class as shown below in table 3.3.1.

3.3.1 Tolerance of spherical bore diameter of housings

Nominal dimension of spherical bore diameter d (mm)		Housing for interference fit	
		Tolerance class J7	
		D_{1m}	
over	incl.	high	low
30	50	+14	-11
50	80	+18	-12
80	120	+22	-13
120	180	+26	-14
180	250	+30	-16
250	315	+36	-16

Unit = 0.001 mm

3.3.2 Dimensional accuracies of pillow block-type housings

Tolerance of pillow block center height

Housing no. P, UP	Tolerance of H
203-210	±150
211-218	±200

Unit = 0.001 mm

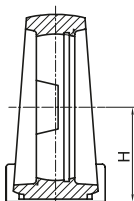

3.3.3 Dimensional accuracies of flange-type housings

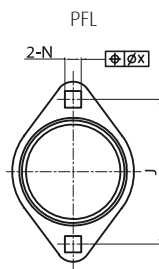
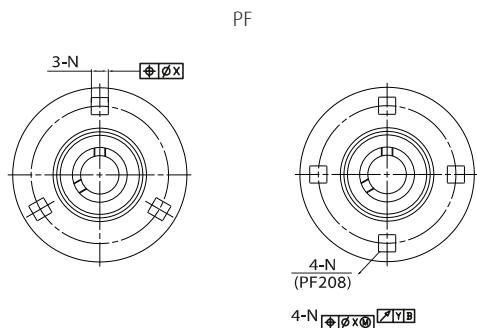
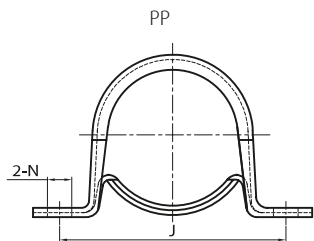
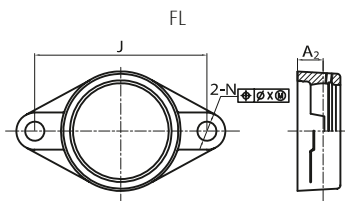
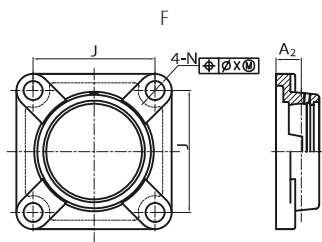

3. Tolerances

Tolerance of housings

Housing no. F, FL	X ≤	ΔA ₂	Housing no. FC	Tolerance of ΔH ₃		X ≤	ΔA ₂	Y ≤
				FC 2 ..				
				max.	min.			
204	700	±500	204	0	-46	700	±500	200
205								
206								
207			-54					
208								
209								
210								
211	1000	±800	211	0	-63	1000	±800	300
212								
213								
214								
215								
216								
217								
218			-72					

Unit = 0.001 mm

Tolerance of pressed steel housings

Housing no.	Δ N	Tolerance of J	Housing no.	Δ N	Tolerance of mounting hole position
PP203-208	±0.5	±0.4	PF203-208 PFL203-208	±0.2	0.4

Unit = 1mm

4. Load Rating and Life

4.1 Bearing life

Even in bearings operating under normal conditions, the surfaces of the raceway and rolling elements are constantly being subjected to repeated compressive stresses which cause flaking of these surfaces to occur. This flaking is due to material fatigue and will eventually cause the bearings to fail. The bearing life of an insert bearing is usually defined in terms of the total number of revolutions a bearing can undergo before flaking.

Some insert bearing failures are caused by seizing, abrasions, cracking, chipping, gnawing, rust etc. which may be caused by improper installation, insufficient or improper lubrication, faulty sealing or inaccurate bearing selection. These failures must be considered separately from bearing life.

4.1.1 Basic load rating and rated life

Basic load rating includes basic dynamic load rating and basic static load rating. The load applied to the insert bearing operating under a speedy rotating ($n > 10$ rpm) condition is defined as dynamic load C , while the load applied to the bearing operating under a static or slowly oscillating and rotating ($n \leq 10$ rpm) condition is defined as static load C_0 . An insert bearing is a kind of radial ball bearing, and radial force is generally applied to such bearings. So, the basic load rating is radial basic dynamic load C_r and radial basic static load C_{or} .

Basic dynamic load rating C_r : the basic dynamic load rating is an expression of the load capacity of a bearing based on the constant load which the bearing can sustain for one million revolutions.

Basic static load rating C_{or} : the maximum applied radial load resulting in contact stress which occurs at the contact points of the rolling element and the raceway, which are as follows:

- 4,600 MPa for self-aligning ball bearings
- 4,200 MPa for radial ball bearings
- 4,000 MPa for radial roller bearings

The load capacity of the bearing is expressed by the basic dynamic load rating and basic static load rating which are shown in the bearing dimension page.

Life: the life of a rolling bearing is defined as the total number of revolutions which the bearing is capable of enduring before the first evidence of fatigue flaking develops on any of the single ring or rolling elements.

Reliability: the reliability is the percentage of bearings within a group of apparently identical bearings operating under identical conditions which would be expected to attain or exceed a certain defined life. The reliability of an individual bearing is the probability that the bearing will attain or exceed a defined life.

Basic rating life: for a group of apparently identical rolling bearings operating under identical conditions, the basic rating life is defined as the total number of revolutions that 90% of the bearings can be expected to complete or exceed.

According to national standard GB/T 6391-2003 (equivalent to ISO 281:1990), the basic rating life of radial ball bearings is calculated using following formula:

$$L_{10} = \left(\frac{C_r}{P} \right)^3$$

or $\frac{C_r}{P} = L_{10}^{1/3}$

- Where:
- L_{10} : basic rating life(10^6 r)
 - C_r : basic dynamic load rating
 - P: equivalent dynamic load

4. Load Rating and Life

Equivalent dynamic load P: the equivalent dynamic load is a constant load with a fixed direction under which the bearing life is identical to that of the bearing operating under actual load.

For an insert bearing operating with a constant rotation speed, the basic rating life can be expressed in terms of hours of operation, and is calculated using the following formula:

$$L_{10h} = \frac{10^6}{60n} \left(\frac{C_1}{P} \right)^3$$

or
$$L_{10h} = \frac{10^6}{60n} L_{10}$$

$$= \frac{16666}{n} \left(\frac{C_1}{P} \right)^3$$

Where: L_{10h} = basic rating life (hours)
 n = bearing rotation speed (rpm)

If the bearing operates under indeterminate loads and rotation speed, the following formula is to be applied when calculating bearing rating life:

$$P_m = \sqrt[3]{\frac{\int_0^N P^3 dn}{N}}$$

Where: P_m = mean equivalent dynamic load
 P = equivalent dynamic load
 N = total number of revolutions within one load-changing cycle

4.1.2 Calculation of equivalent dynamic load

The basic equivalent dynamic load is determined under a hypothetical condition. When calculating the bearing life, the actual load has to be converted into equivalent dynamic load which is in conformity with the load condition which determines the equivalent dynamic load rating. The general equation for calculating the equivalent dynamic load is as follows:

$$P = XF_r + YF_a$$

- Where:
- P = equivalent dynamic load (N);
 - F_r = actual radial load (N)
 - F_a = actual axial load (N)
 - X = radial factor
 - Y = thrust factor

The axial load which an insert bearing can carry is determined by the method used to mount the bearings on the shafts.

If we consider the set screw locking type or eccentric locking collar type bearings, then, if flexible shafts are applied and the setscrews are tightened enough, the axial load F_a that the bearing can carry must not surpass 20% of the radial load F_r .

For the adapter sleeve locking type bearing, if the nuts are properly lightened, the axial load F_a may attain a maximum of 15%~20% of the radial load F_r .

The values of radial and thrust factors X and Y for insert bearings can be obtained from the following table:

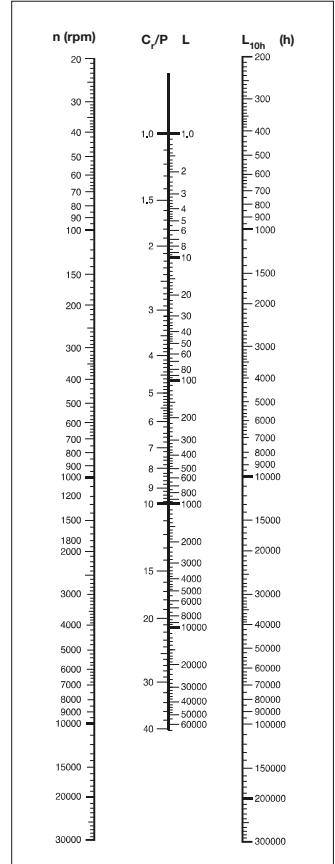

4. Load Rating and Life

$\frac{F_a}{C_0}$	$\frac{F_a}{F_r} \leq e$		C2			N			C3		
	$P = F_r$		$\frac{F_a}{F_r} > e$		e	$\frac{F_a}{F_r} > e$		e	$\frac{F_a}{F_r} > e$		e
	X	Y	X	Y		X	Y		X	Y	
0.025	1	0	0.56	2.0	0.22	0.46	1.75	0.31	0.44	1.42	0.40
0.040	1	0	0.56	1.8	0.24	0.46	0.62	0.33	0.44	1.36	0.42
0.070	1	0	0.56	1.6	0.27	0.46	1.46	0.36	0.44	1.27	0.44
0.130	1	0	0.56	1.4	0.31	0.46	1.30	0.41	0.44	1.16	0.48
0.250	1	0	0.56	1.2	0.37	0.46	1.14	0.46	0.44	1.05	0.53

When twist load is applied to the bearings, the equivalent dynamic bearing load is calculated using:

$$P_m = f_m \cdot P$$

Where: P_m = equivalent dynamic load when considering twist load

$$f_m = \text{when twist load is large : } f_m = 2$$

When shocking load is applied, the equivalent dynamic load can be calculated using:

$$P_d = f_d \cdot P$$

Where: P_d = equivalent dynamic load when considering shocking load (N)

f_m = shocking load factor, which is defined as follows:

When no shocking load or minor shocking load is applied:

$$f_d = 1 \sim 1.2$$

When adequate shocking load is applied:

$$f_d = 1.2 \sim 1.8$$

4.1.3 Adjusted rating life equation

Normally, the basic rating life L_{10} can be applied to calculate the bearing rating life, and in this instance, the bearing life has 90% reliability.

However, in some applications a bearing life with over 90% reliability may be required, and in addition, the effects of bearing quality and operation conditions must be taken into consideration when calculating bearing life. The adjusted bearing life L_{nm} (n = failure rate, $(100 - n)$ = reliability) needs to be taken consideration when calculating bearing life in order to meet these requirements.

Bearing life L_{nm} is the adjusted bearing life under $(100 - n)\%$ reliability, specified bearing quality and operation conditions. It can be calculated using:

$$L_{nm} = a_1 a_{xyz} L_{10}$$

For the life adjustment factor for reliability a_1 , please refer to the following table.

Life adjustment factor for reliability a_1

Reliability	L_{nm}	a_1
90	L_{10m}	1
95	L_{5m}	0.62
96	L_{4m}	0.53
97	L_{3m}	0.44
98	L_{2m}	0.33
99	L_{1m}	0.21

Life adjustment factor a_{xyz} includes the following:

- › Material
- › Lubrication
- › Environment
- › Impurity particle
- › Internal stress
- › Mounting
- › Bearing load

The bearing life is affected by all of the above factors, therefore all factors must be taken into consideration when selecting a bearing to avoid failure. Please refer to national standard GB/T 6391-2003 for the calculation method of the bearing life.

4.1.4 Example of insert bearing selection

A ball bearing is to operate at a rotation speed of 800 rpm, under only a radial load of $F_r = 3,000$ N, with a basic rating life of at least 30,000 hours. Select the bearing.

Solution 1:

According to formula

$$L_{10h} = \frac{10^6}{60n} L_{10} = \frac{16666}{n} \left(\frac{C_r}{P} \right)^3$$

From $L_{10h} = 30,000$ hours, rotation speed = 800 rpm,

Under only a radial load, i.e. $P = F_r = 3,000$ N,

Therefore, $C_r = 33\ 877$ N.

Solution 2:

By connecting n (800 rpm) and the required basic rating life L_{10h} (30,000 hours) with a straight line on the diagram, we find that the C/P value is 11.3. $C_r/P = 11.3$, $P = F_r = 3,000$ N, and therefore the required basic dynamic load rating is $C_r = 33,900$ N

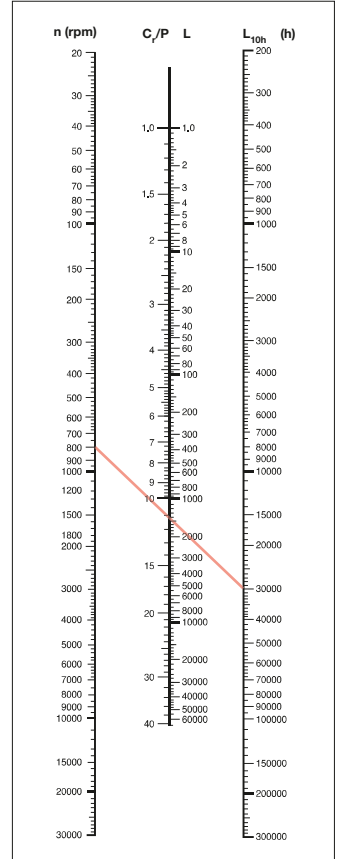

4.2 Selection of ball bearing units

As a society, we have long been aware of the merits of ball bearings, and therefore its application fields are constantly being expanded. At present, ball bearings are used in all aspects of industrial activities.

A ball bearing's expected service life can be doubled by using the ball bearing correctly. Vice versa, inappropriate selection and handling will shorten expected service life. Therefore, it is necessary to consider the following items when making the selection.

1. Size and nature of the working load.
2. Desirable minimum expected service life.
3. Operating speed of the shaft.
4. Number of ball bearing units and arrangement on the shaft.
5. Space available for assembling and disassembling work.
6. Appearance when installed.
7. Gas generation and dust conditions in working environment when installed.

4. Load Rating and Life

8. Ambient temperature when installed.
9. Machining precision of accuracy of the shaft and mounting surface. The bearing is applied.
10. Maintenance and control, including the lubrication system.

The above items are regarded as the selection conditions, and the items 1, 2 and 3 can be used for calculating the service life of the ball bearing unit.

As to item 4, such a type as allows the alignment to be adjusted during the installation process, must be selected, as mutual alignment work is necessary even for the self-aligning adjusting type, where many sets of bearings can be applied to one shaft.

Regarding item 5, an review must be carried out to see whether enough installation space is available or not, in order to determine how the installation work can be done.

Item 6 suggests the need for a clean and aesthetic design, depending on the application purpose of the machine involved. For example, consideration of the aesthetic design is necessary when the unit is installed in an visible position.

Items 7 and 8 state that studies must be carried out in order to determine whether gas, chemicals-, or a high temperature, which are harmful to the ball bearing, are present or not.

As stated in item 9, the ball bearing unit must match the accuracy of the other components of the installation.

Item 10 covers the issue of maintenance and inspection, for example, how easily maintenance can be performed, whether the unit is installed inside a machine, which makes it difficult to lubricate the bearing, or whether the bearing requires lubrication and how this is to be carried out. The optimum selection of the bearing unit which is right for the application, will ensure that the ball bearing unit will function optimally.

4.3 Selection of shafts

The ball bearing unit is provided with two hollow point, socket-head set screws at 120° to each other in the inner ring. When the unit is mounted on the shaft, a loose fit is usually achieved. In this case, it is recommended that the relationship between the shaft and the inner bore is set up in line with the table below.

Dimensional accuracy of the shaft to be used in the cylindrical bore insert bearing (loose fit)

Shaft diameter (mm)		for lower speed		for medium speed		for rather high speed		for high speed	
		h9		h8		h7		j6	
over	incl.	max.	min.	max.	min.	max.	min.	max.	min.
10	18	0	-43	0	-27	0	-18	+8	-3
18	30	0	-52	0	-33	0	-21	+9	-4
30	50	0	-62	0	39	0	-25	+11	-5
50	80	0	-74	0	-46	0	-30	+12	-7
80	120	0	-87	0	-54	0	-35	+13	-9
120	180	0	-100	0	-63	0	-40	+14	-11

Unit = 0.001 mm

However, if the ball bearing unit is used at a high rotation speed or under heavy load, the shaft fit must be tight. The bearing can be also installed on the shaft using the adapter assembly. This is a convenient solution that can be used as the intermediate bearing of a relatively long shaft or when a slight difference is found at the shaft dimension. In this method, the bearing inner diameter has a 1:12 taper and the corresponding tapered adapter sleeve is applied, followed by tightening of the nut: Therefore, a slight difference in shaft diameter does not cause much trouble.

Dimensional accuracy of the shaft to be used in cylindrical bore insert bearing (interference fit)

Shaft diameter (mm)		Shaft tolerance							
		for higher speeds		for rather heavy loads		for highest speeds		for heavy loads	
		m6		m7		n6		n7	
over	incl.	max.	min.	max.	min.	max.	min.	max.	min.
10	18	+18	+7	+25	+7	+23	+12	+30	+12
18	30	+21	+8	+29	+8	+28	+15	+36	+15
30	50	+25	+9	+34	+9	+33	+17	+42	+17
50	80	+30	+11	+41	+11	+39	+20	+50	+20
80	120	+35	+13	+48	+13	+45	+23	+58	+23
120	180	+40	+15	+55	+15	+52	+27	+67	+27

Unit = 0.001 mm

Dimensional accuracy of the shaft to be used in the taper bore insert bearing

Shaft diameter (mm)		Shaft tolerance			
		for short shafts		for long shafts	
		h9		h10	
over	incl.	max.	min.	max.	min.
10	18	0	-43	0	-70
18	30	0	-52	0	-84
30	50	0	-62	0	-100
50	80	0	-74	0	-120
80	120	0	-87	0	-140
120	180	0	-100	0	-160

Unit = 0.001 mm

4. Load Rating and Life

4.4 Limiting speed

The limiting speeds of ball bearing units are mainly determined by the fit between the bearings and the shafts. Normally, clearance fit is used between set screws type and eccentric collar type bearing units and shafts, and here h7 shaft tolerance is selected. h8 or h9 tolerances are applied for light load and slow-speed applications. The tighter j7 tolerance is applied for heavy loads and high speeds. The shaft applied to the adapter sleeve bearing is h9, with IT5 class tolerances.

The limiting speeds for the ball bearing units with different fits are shown in following table.

d (mm)	200 Series			
	Shaft tolerance			
over	J57(h9/IT5)	h7	h8	h9
12	6700	5300	3800	1400
15	6700	5300	3800	1400
17	6700	5300	3800	1400
20	6000	4800	3400	1200
25	5600	4000	3000	1000
30	4500	3400	2400	850
35	4000	3000	2000	750
40	3600	2600	1900	670
45	3200	2400	1700	600
50	3000	2200	1600	560
55	2600	2000	1400	500
60	2400	1800	1200	450
65	2200	1700	1100	430
70	2200	1600	1100	400
75	2000	1500	1000	380
80	1900	1400	950	340
85	1800	1300	900	320
90	1700	1200	800	300
95	--	--	--	--
100	--	--	--	--
105	--	--	--	--
110	--	--	--	--
120	--	--	--	--
130	--	--	--	--
140	--	--	--	--

Notes: 1. The J57(h9/IT5) column is applied for adapter sleeve type ball bearing units, and columns h7-h9 are applied for the set screw type and eccentric locking collar type ball bearing units.

2. The above table data is used as a reference for SL type dual seal and L3 type triple lip seal products only.

5. Lubrication

5.1 Permissible speed

Permissible speed of an insert bearing is normally expressed in terms of dn value (bearing bore diameter mm x operating speed rpm), although it is influenced by the shape, size, lubricant type and seal device. The permissible speed can be roughly determined by the sliding speed at the friction interface between the holding device and rolling body. The ball bearing unit, it is provided with grease sealed by the oil seals and slingers. Accordingly, the friction resistance at the seal contact also has a significant influence on the permissible speed.

When these factors are taken into consideration, the permissible speed is given as follows:

$$dn \leq 150,000 \quad [dn = d \times n]$$

Where, d : Bearing bore diameter (mm)
 n : Operating speed (rpm)

5.2 Type of grease nipple

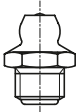

Type A

Housing size	Type of grease nipple
203-210	M6X1
211-215	M8X1
216-218	M10X1

5.3 Location of grease nipple

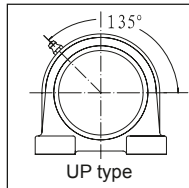
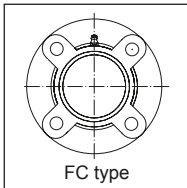
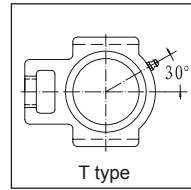
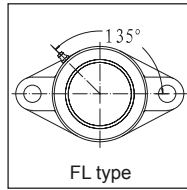
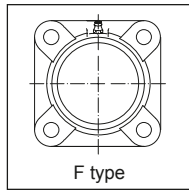
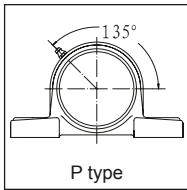

5. Lubrication

5.4 Lubricant grease

The grease used in J-Line bearing inserts is Shell Gadus S2-V1002, a high quality lithium-based grease.

5.5 Replenishment of grease

NSK J-Line Bearings are factory charged with the correct amount of grease.

Relubrication is not normally necessary except when operating under extreme temperatures, speeds and loads, or where excessively wet or dirty conditions exist.

The relubrication frequency varies dependent on the type and quality of grease used as well as the operating conditions. Therefore, it is difficult to establish a general rule, but under ordinary operating conditions, it is desirable that grease be replenished before one third ($\frac{1}{3}$) of its calculated life elapses. However, it is necessary to take into consideration such factors as hardening of grease in the oil hole, which makes replenishment impossible, or deterioration of grease due to oxidation while the machine is running.

The following table shows standard relubrication frequencies. Irrespective of the calculated life of the grease, this list takes into consideration such factors as the rotational speed of the bearings, operating temperatures and environmental conditions, with a view to safety.

The performance of a bearing is greatly influenced by the quantity of grease. In order to avoid overfilling, it is advisable to replenish the grease while the machine is in operation. For optimum performance, continue to insert grease until it slightly oozes out from beneath the sealing lip on the inner ring.

All standard J-Line bearing units have 1/4"-28UNF grease nipples, except for the FC series units which have M5 x 0.8 mm pitch grease nipples.

Standard relubrication frequencies

Type of unit	dn value	Environmental conditions	Operating temp. °C, °F		Relubrication frequency	
					Hours	Period
Standard	40000 and below	Ordinary	-15 to +80	+5 to +176	1500 to 3000	6 to 12 mths.
Standard	70000 and below	Ordinary	-15 to +80	+5 to +176	1000 to 2000	3 to 6 mths.
Standard	70000 and below	Ordinary	+80 to +100	+176 to +212	500 to 700	1 mth.
Standard	70000 and below	Very dusty	-15 to +100	+5 to +212	100 to 500	1 wk. to 1 mth.
Standard	70000 and below	Exposed to water splashes	-15 to +100	+5 to +212	30 to 100	1 day to 1 wk.

dn = bore diameter (mm) · speed (rpm)

6. Mounting instructions for J-Line bearing units

J-Line set screw locking arrangement units

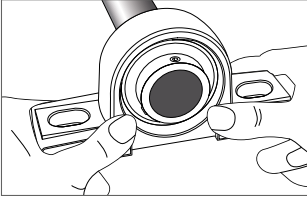

1. Loosen set screws until the bore is clear and slide the bearing onto the shaft.

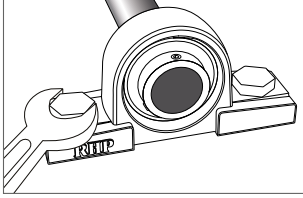

2. Bolt the unit down onto a flat surface, but do not over-tighten.

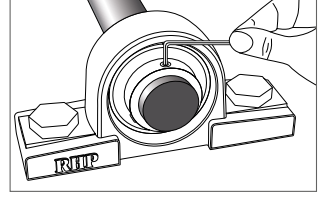

3. Tighten set screws to recommended torque.

J-Line eccentric collar locking arrangements units

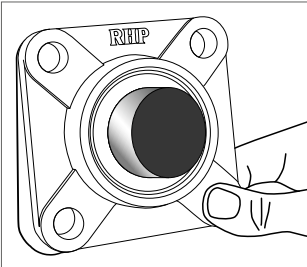

1. Assemble bearing and housing and slide them onto the shaft. Do not engage collar.

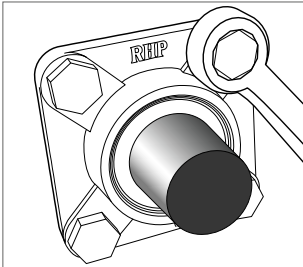

2. Lightly tighten bolts, repeat at other end of shaft and then finally tighten bolts on both sides.

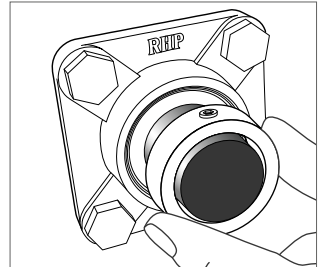

3. Engage the eccentric collar in direction of shaft rotation.

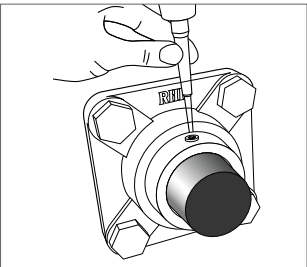

4. Tighten collar with drift pin and small hammer.

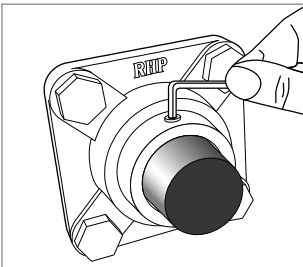

5. Tighten collar set screw to recommended torque.

J-Line assembly of insert bearing into housing

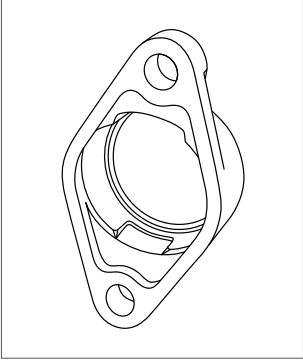

1. Fix empty housing in a vice or similar.

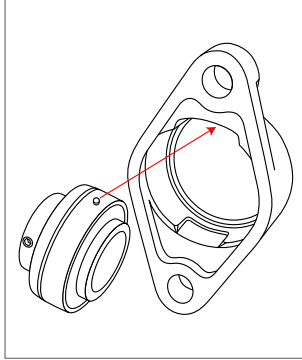

2. Position the pin stop of the insert bearing in line with the pocket of the flange.

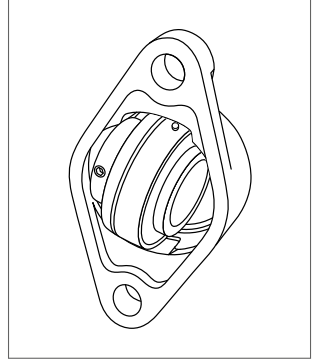

3. Put the insert bearing into the pockets of the flange.

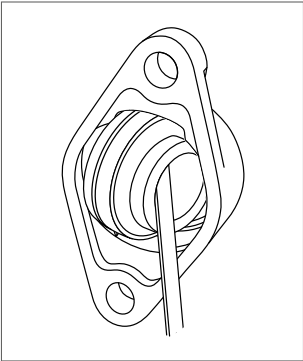

4. Use a rod to turn the bearing into position.

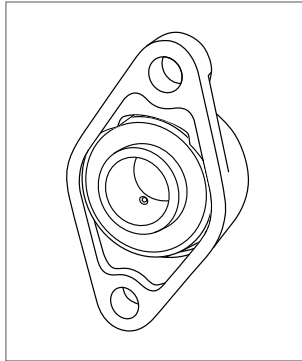

5. J-Line bearing unit ready to use.



II. Dimension Tables

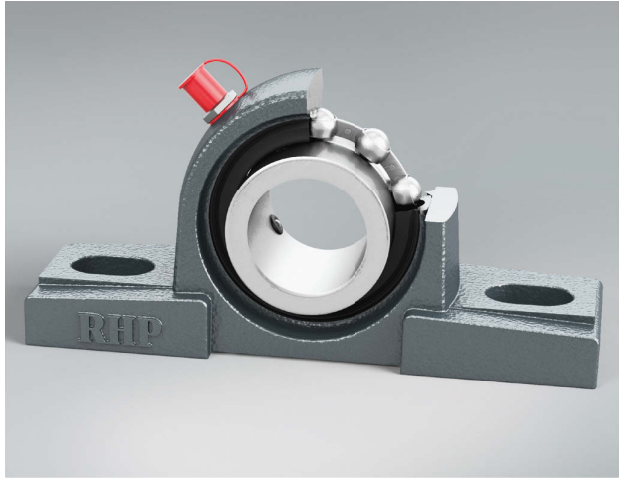

Pillow Block Units

UCP2

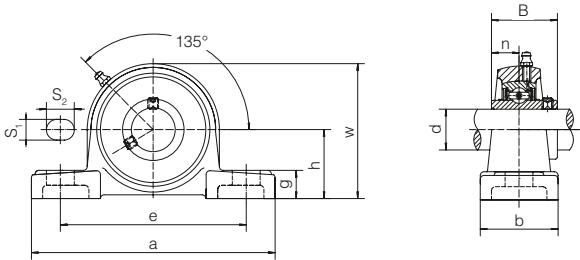

Unit number	Dimensions (mm)										
	d	h	a	e	b	S ₁	S ₂	g	w	B	n
UCP201D1	12	30.2	127	95	38	13	19	14	62	31	12.7
UCP202D1	15	30.2	127	95	38	13	19	14	62	31	12.7
UCP203D1	17	30.2	127	95	38	13	19	14	62	31	12.7
UCP204D1	20	33.3	127	95	38	13	19	14	65	31.0	12.7
UCP205D1	25	36.5	140	105	38	13	19	15	71	34.1	14.3
UCP206D1	30	42.9	160	121	44	17	20	17	84	38.1	15.9
UCP207D1	35	47.6	167	127	48	17	20	18	93	42.9	17.5
UCP208D1	40	49.2	184	137	54	17	20	18	100	49.2	19
UCP209D1	45	54.0	190	146	54	17	20	20	106	49.2	19
UCP210D1	50	57.2	206	159	60	20	23	21	113	51.6	19.0
UCP211D1	55	63.5	219	171	60	20	23	23	125	55.6	22.2
UCP212D1	60	69.8	241	184	70	20	23	25	138	65.1	25.4
UCP213D1	65	76.2	265	203	70	25	28	27	150	65.1	25.4
UCP214D1	70	79.4	266	210	72	25	28	27	156	74.6	30.2
UCP215D1	75	82.6	275	217	74	25	28	28	162	77.8	33.3
UCP216D1	80	88.9	292	232	78	25	28	30	174	82.6	33.3
UCP217D1	85	95.2	310	247	83	25	28	32	185	85.7	34.1
UCP218D1	90	101.6	327	262	88	27	30	33	198	96.0	39.7

Bolt size (mm)	Bearing number	Housing number	Weight (kg)
M10	UC201D1	P201D1	0.65
M10	UC202D1	P202D1	0.64
M10	UC203D1	P203D1	0.63
M10	UC204D1	P204D1	0.64
M10	UC205D1	P205D1	0.76
M14	UC206D1	P206D1	1.20
M14	UC207D1	P207D1	1.46
M14	UC208D1	P208D1	1.86
M14	UC209D1	P209D1	2.06
M16	UC210D1	P210D1	2.61
M16	UC211D1	P211D1	3.23
M16	UC212D1	P212D1	4.40
M20	UC213D1	P213D1	5.35
M20	UC214D1	P214D1	5.86
M20	UC215D1	P215D1	6.45
M20	UC216D1	P216D1	7.86
M20	UC217D1	P217D1	9.56
M22	UC218D1	P218D1	11.59

Pillow Block Units

UEL P2

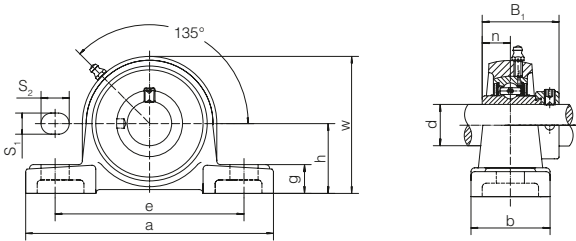

Unit number	Dimensions (mm)										
	d	h	a	e	b	S ₁	S ₂	g	w	B ₁	n
UEL P204D1	20	33.3	127	95	38	13	19	14	65	43.7	17.1
UEL P205D1	25	36.5	140	105	38	13	19	15	71	44.4	17.5
UEL P206D1	30	42.9	160	121	44	17	20	17	84	48.4	18.3
UEL P207D1	35	47.6	167	127	48	17	20	18	93	51.1	18.8
UEL P208D1	40	49.2	184	137	54	17	20	18	100	56.3	21.4
UEL P209D1	45	54.0	190	146	54	17	20	20	106	56.3	21
UEL P210D1	50	57.2	206	159	60	20	23	21	113	62.7	24.6
UEL P211D1	55	63.5	219	171	60	20	23	23	125	71.4	27.8
UEL P212D1	60	69.8	241	184	70	20	23	25	138	77.8	31.0
UEL P213D1	65	76.2	265	203	70	25	28	27	150	85.7	34.1
UEL P214D1	70	79.4	266	210	72	25	28	27	156	85.7	34.1
UEL P215D1	75	82.6	275	217	74	25	28	28	162	92.1	37.3

Bolt size (mm)	Bearing number	Housing number	Weight (kg)
M10	UEL204D1	P204D1	0.70
M10	UEL205D1	P205D1	0.81
M14	UEL206D1	P206D1	1.27
M14	UEL207D1	P207D1	1.60
M14	UEL208D1	P208D1	1.99
M14	UEL209D1	P209D1	2.19
M16	UEL210D1	P210D1	2.80
M16	UEL211D1	P211D1	3.50
M16	UEL212D1	P212D1	4.76
M20	UEL213D1	P213D1	5.89
M20	UEL214D1	P214D1	6.27
M20	UEL215D1	P215D1	6.93

Pillow Block Units

UKP2

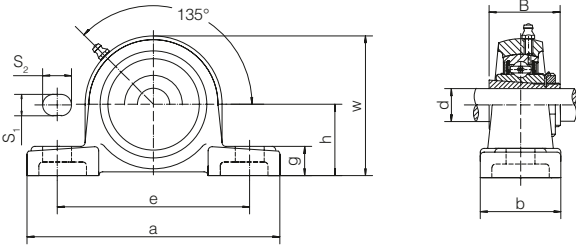

Unit number	Dimensions (mm)									
	d	h	a	e	b	S ₁	S ₂	g	w	B
UKP205D1+H2305	20	36.5	140	105	38	13	19	15	71	35
UKP206D1+H2306	25	42.9	160	121	44	17	20	17	84	38
UKP207D1+H2307	30	47.6	167	127	48	17	20	18	93	43
UKP208D1+H2308	35	49.2	184	137	54	17	20	18	100	46
UKP209D1+H2309	40	54.0	190	146	54	17	20	20	106	50
UKP210D1+H2310	45	57.2	206	159	60	20	23	21	113	55
UKP211D1+H2311	50	63.5	219	171	60	20	23	23	125	59
UKP212D1+H2312	55	69.8	241	184	70	20	23	25	138	62
UKP213D1+H2313	60	76.2	265	203	70	25	28	27	150	65
UKP215D1+H2315	65	82.6	275	217	74	25	28	28	162	73
UKP216D1+H2316	70	88.9	292	232	78	25	28	30	174	78
UKP217D1+H2317	75	95.2	310	247	83	25	28	32	185	82
UKP218D1+H2318	80	101.6	327	262	88	27	30	33	198	86

Bolt size (mm)	Bearing number	Housing number	Weight (kg)
M10	UK205D1+H2305	P205D1	0.81
M14	UK206D1+H2306	P206D1	1.26
M14	UK207D1+H2307	P207D1	1.53
M14	UK208D1+H2308	P208D1	1.93
M14	UK209D1+H2309	P209D1	2.18
M16	UK210D1+H2310	P210D1	2.78
M16	UK211D1+H2311	P211D1	3.39
M16	UK212D1+H2312	P212D1	4.52
M20	UK213D1+H2313	P213D1	5.47
M20	UK215D1+H2315	P215D1	6.84
M20	UK216D1+H2316	P216D1	8.29
M20	UK217D1+H2317	P217D1	9.97
M22	UK218D1+H2318	P218D1	11.89

Flange Units (Square) UCF2

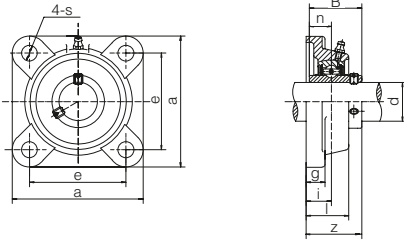

Unit number	Dimensions (mm)										
	d	a	e	i	g	l	s	z	B	n	
UCF201D1	12	86	64	15	12	25.5	12	33.3	31	12.7	
UCF202D1	15	86	64	15	12	25.5	12	33.3	31	12.7	
UCF203D1	17	86	64	15	12	25.5	12	33.3	31	12.7	
UCF204D1	20	86	64	15	12	25.5	12	33.3	31	12.7	
UCF205D1	25	95	70	16	14	27	12	35.8	34.1	14.3	
UCF206D1	30	108	83	18	14	31	12	40.2	38.1	15.9	
UCF207D1	35	117	92	19	16	34	14	44.4	42.9	17.5	
UCF208D1	40	130	102	21	16	36	16	51.2	49.2	19	
UCF209D1	45	137	105	22	18	38	16	52.2	49.2	19	
UCF210D1	50	143	111	22	18	40	16	54.6	51.6	19	
UCF211D1	55	162	130	25	20	43	19	58.4	55.6	22.2	
UCF212D1	60	175	143	29	20	48	19	68.7	65.1	25.4	
UCF213D1	65	187	149	30	22	50	19	69.7	65.1	25.4	
UCF214D1	70	193	152	31	22	54	19	75.4	74.6	30.2	
UCF215D1	75	200	159	34	22	56	19	78.5	77.8	33.3	
UCF216D1	80	208	165	34	22	58	23	83.3	82.6	33.3	
UCF217D1	85	220	175	36	24	63	23	87.6	85.7	34.1	
UCF218D1	90	235	187	40	24	68	23	96.3	96	39.7	

Bolt size (mm)	Bearing number	Housing number	Weight (kg)
M10	UC201D1	F201D1	0.59
M10	UC202D1	F202D1	0.58
M10	UC203D1	F203D1	0.57
M10	UC204D1	F204D1	0.55
M10	UC205D1	F205D1	0.73
M10	UC206D1	F206D1	1.02
M12	UC207D1	F207D1	1.33
M14	UC208D1	F208D1	1.67
M14	UC209D1	F209D1	2.00
M14	UC210D1	F210D1	2.32
M16	UC211D1	F211D1	3.12
M16	UC212D1	F212D1	3.95
M16	UC213D1	F213D1	4.81
M16	UC214D1	F214D1	5.42
M16	UC215D1	F215D1	5.94
M20	UC216D1	F216D1	6.94
M20	UC217D1	F217D1	8.67
M20	UC218D1	F218D1	10.62

Flange Units (Square) UELF2

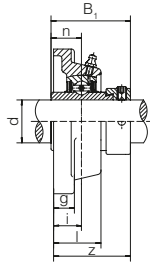
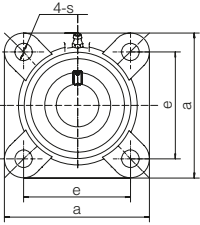

Unit number	Dimensions (mm)									
	d	a	e	i	g	l	s	z	B ₁	n
UELF204D1	20	86	64	15	12	25.5	12	41.6	43.7	17.1
UELF205D1	25	95	70	16	14	27	12	42.9	44.4	17.5
UELF206D1	30	108	83	18	14	31	12	48.1	48.4	18.3
UELF207D1	35	117	92	19	16	34	14	51.3	51.1	18.8
UELF208D1	40	130	102	21	16	36	16	55.9	56.3	21.4
UELF209D1	45	137	105	22	18	38	16	56.9	56.3	21.4
UELF210D1	50	143	111	22	18	40	16	60.1	62.7	24.6
UELF211D1	55	162	130	25	20	43	19	68.6	71.4	27.8
UELF212D1	60	175	143	29	20	48	19	75.8	77.8	31
UELF213D1	65	187	149	30	22	50	19	81.6	85.7	34.1
UELF214D1	70	193	152	31	22	54	19	82.6	85.7	34.1
UELF215D1	75	200	159	34	22	56	19	88.8	92.1	37.3

Bolt size (mm)	Bearing number	Housing number	Weight (kg)
M10	UEL204D1	F204D1	0.60
M10	UEL205D1	F205D1	0.79
M10	UEL206D1	F206D1	1.10
M12	UEL207D1	F207D1	1.47
M14	UEL208D1	F208D1	1.80
M14	UEL209D1	F209D1	2.13
M14	UEL210D1	F210D1	2.51
M16	UEL211D1	F211D1	3.39
M16	UEL212D1	F212D1	4.27
M16	UEL213D1	F213D1	5.35
M16	UEL214D1	F214D1	5.84
M16	UEL215D1	F215D1	6.43

Flange Units (Square) UKF2

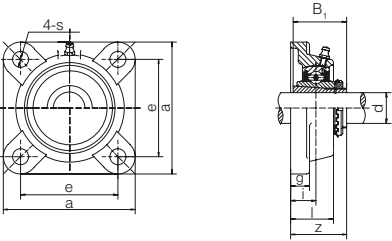

Unit number	Dimensions (mm)								
	d	a	e	i	g	l	s	z	B ₁
UKF205D1+H2305	20	95	70	16	14	27	12	35.5	35
UKF206D1+H2306	25	108	83	18	14	31	12	39	38
UKF207D1+H2307	30	117	92	19	16	34	14	42.5	43
UKF208D1+H2308	35	130	102	21	16	36	16	46.5	46
UKF209D1+H2309	40	137	105	22	18	38	16	48.5	50
UKF210D1+H2310	45	143	111	22	18	40	16	50	55
UKF211D1+H2311	50	162	130	25	20	43	19	54.5	59
UKF212D1+H2312	55	175	143	29	20	48	19	61	62
UKF213D1+H2313	60	187	149	30	22	50	19	64	65
UKF215D1+H2315	65	200	159	34	22	56	19	71	73
UKF216D1+H2316	70	208	165	34	22	58	23	73.5	78
UKF217D1+H2317	75	220	175	36	24	63	23	77	82
UKF218D1+H2318	80	235	187	40	24	68	23	81.5	86

Bolt size (mm)	Bearing number	Housing number	Weight (kg)
M10	UK205D1+H2305	F205D1	0.78
M10	UK206D1+H2306	F206D1	1.09
M12	UK207D1+H2307	F207D1	1.41
M14	UK208D1+H2308	F208D1	1.74
M14	UK209D1+H2309	F209D1	2.12
M14	UK210D1+H2310	F210D1	2.49
M16	UK211D1+H2311	F211D1	3.28
M16	UK212D1+H2312	F212D1	4.03
M16	UK213D1+H2313	F213D1	4.93
M16	UK215D1+H2315	F215D1	6.33
M20	UK216D1+H2316	F216D1	7.37
M20	UK217D1+H2317	F217D1	9.09
M20	UK218D1+H2318	F218D1	10.91

Flange Cartridge Units UCFC2

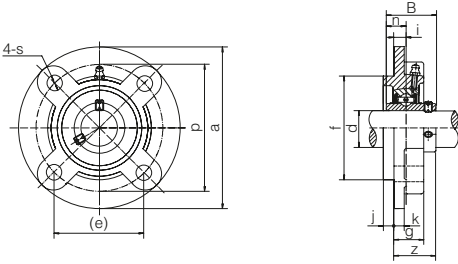

Unit number	Dimensions (mm)												
	d	a	p	e	i	s	j	k	g	f	z	B	n
UCFC201D1	12	100	78	55.1	10	12	5	7	20.5	62	28.3	31.0	12.7
UCFC202D1	15	100	78	55.1	10	12	5	7	20.5	62	28.3	31.0	12.7
UCFC203D1	17	100	78	55.1	10	12	5	7	20.5	62	28.3	31.0	12.7
UCFC204D1	20	100	78	55.1	10	12	5	7	20.5	62	28.3	31.0	12.7
UCFC205D1	25	115	90	63.6	10	12	6	7	21	70	29.8	34.1	14.3
UCFC206D1	30	125	100	70.7	10	12	8	8	23	80	32.2	38.1	15.9
UCFC207D1	35	135	110	77.8	11	14	8	9	26	90	36.4	42.9	17.5
UCFC208D1	40	145	120	84.8	11	14	10	9	26	100	41.2	49.2	19.0
UCFC209D1	45	160	132	93.3	10	16	12	14	26	105	40.2	49.2	19.0
UCFC210D1	50	165	138	97.6	10	16	12	14	28	110	42.6	51.6	19.0
UCFC211D1	55	185	150	106.1	13	19	12	15	31	125	46.4	55.6	22.2
UCFC212D1	60	195	160	113.1	17	19	12	15	36	135	56.7	65.1	25.4
UCFC213D1	65	205	170	120.2	16	19	14	15	36	145	55.7	65.1	25.4
UCFC214D1	70	215	177	125.1	17	19	14	18	40	150	61.4	74.6	30.2
UCFC215D1	75	220	184	130.1	18	19	16	18	40	160	62.5	77.8	33.3
UCFC216D1	80	240	200	141.4	18	23	16	18	42	170	67.3	82.6	33.3
UCFC217D1	85	250	208	147.1	18	23	18	20	45	180	69.6	85.7	34.1
UCFC218D1	90	265	220	155.5	22	23	18	20	50	190	78.3	96.0	39.7

Bolt size (mm)	Bearing number	Housing number	Weight (kg)
M10	UC201D1	FC201D1	0.70
M10	UC202D1	FC202D1	0.69
M10	UC203D1	FC203D1	0.68
M10	UC204D1	FC204D1	0.66
M10	UC205D1	FC205D1	0.89
M10	UC206D1	FC206D1	1.18
M12	UC207D1	FC207D1	1.53
M12	UC208D1	FC208D1	1.85
M14	UC209D1	FC209D1	2.53
M14	UC210D1	FC210D1	2.78
M16	UC211D1	FC211D1	3.86
M16	UC212D1	FC212D1	4.69
M16	UC213D1	FC213D1	5.30
M16	UC214D1	FC214D1	6.46
M16	UC215D1	FC215D1	6.86
M20	UC216D1	FC216D1	8.47
M20	UC217D1	FC217D1	10.18
M20	UC218D1	FC218D1	12.24

Flange Cartridge Units UELFC2

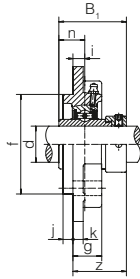
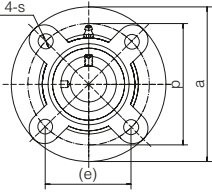

Unit number	Dimensions (mm)												
	d	a	p	e	i	s	j	k	g	f	z	B ₁	n
UELFC204D1	20	100	78	55.1	10	12	5	7	20.5	62	36.6	43.7	17.1
UELFC205D1	25	115	90	63.6	10	12	6	7	21	70	36.9	44.4	17.5
UELFC206D1	30	125	100	70.7	10	12	8	8	23	80	40.1	48.4	18.3
UELFC207D1	35	135	110	77.8	11	14	8	9	26	90	43.3	51.1	18.8
UELFC208D1	40	145	120	84.8	11	14	10	9	26	100	45.9	56.3	21.4
UELFC209D1	45	160	132	93.3	10	16	12	14	26	105	44.9	56.3	21.4
UELFC210D1	50	165	138	97.6	10	16	12	14	28	110	48.1	62.7	24.6
UELFC211D1	55	185	150	106.1	13	19	12	15	31	125	56.6	71.4	27.8
UELFC212D1	60	195	160	113.1	17	19	12	15	36	135	63.8	77.8	31.0
UELFC213D1	65	205	170	120.2	16	19	14	15	36	145	67.6	85.7	34.1
UELFC214D1	70	215	177	125.1	17	19	14	18	40	150	68.6	85.7	34.1
UELFC215D1	75	220	184	130.1	18	19	16	18	40	160	72.8	92.1	37.3

Bolt size (mm)	Bearing number	Housing number	Weight (kg)
M10	UEL204D1	FC204D1	0.72
M10	UEL205D1	FC205D1	0.94
M10	UEL206D1	FC206D1	1.25
M12	UEL207D1	FC207D1	1.67
M12	UEL208D1	FC208D1	1.98
M14	UEL209D1	FC209D1	2.66
M14	UEL210D1	FC210D1	2.97
M16	UEL211D1	FC211D1	4.13
M16	UEL212D1	FC212D1	5.01
M16	UEL213D1	FC213D1	5.84
M16	UEL214D1	FC214D1	6.87
M16	UEL215D1	FC215D1	7.34

Flange Cartridge Units

UKFC2

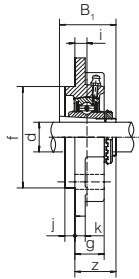
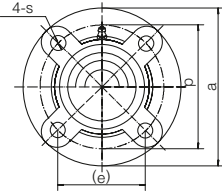

Unit number	Dimensions (mm)											
	d	a	p	e	i	s	j	k	g	f	z	B ₁
UKFC205D1+H2305	20	115	90	63.6	10	12	6	7	21	70	29.5	35
UKFC206D1+H2306	25	125	100	70.7	10	12	8	8	23	80	31	38
UKFC207D1+H2307	30	135	110	77.8	11	14	8	9	26	90	33.5	43
UKFC208D1+H2308	35	145	120	84.8	11	14	10	9	26	100	35.5	46
UKFC209D1+H2309	40	160	132	93.3	10	16	12	14	26	105	36	50
UKFC210D1+H2310	45	165	138	97.6	10	16	12	14	28	110	37.5	55
UKFC211D1+H2311	50	185	150	106.1	13	19	12	15	31	125	41.5	59
UKFC212D1+H2312	55	195	160	113.1	17	19	12	15	36	135	48	62
UKFC213D1+H2313	60	205	170	120.2	16	19	14	15	36	145	49	65
UKFC215D1+H2315	65	220	184	130.1	18	19	16	18	40	160	53.5	73
UKFC216D1+H2316	70	240	200	141.4	18	23	16	18	42	170	57	78
UKFC217D1+H2317	75	250	208	147.1	18	23	18	20	45	180	59	82
UKFC218D1+H2318	80	265	220.0	155.5	22	23	18	20	50	190	64.5	86

Bolt size (mm)	Bearing number	Housing number	Weight (kg)
M10	UK205D1+H2305	FC205D1	0.93
M10	UK206D1+H2306	FC206D1	1.24
M12	UK207D1+H2307	FC207D1	1.60
M12	UK208D1+H2308	FC208D1	1.92
M14	UK209D1+H2309	FC209D1	2.65
M14	UK210D1+H2310	FC210D1	2.96
M16	UK211D1+H2311	FC211D1	4.02
M16	UK212D1+H2312	FC212D1	4.77
M16	UK213D1+H2313	FC213D1	5.41
M16	UK215D1+H2315	FC215D1	7.25
M20	UK216D1+H2316	FC216D1	8.90
M20	UK217D1+H2317	FC217D1	10.60
M20	UK218D1+H2318	FC218D1	12.54

Flange Cartridge Units (Oval) UCFL2

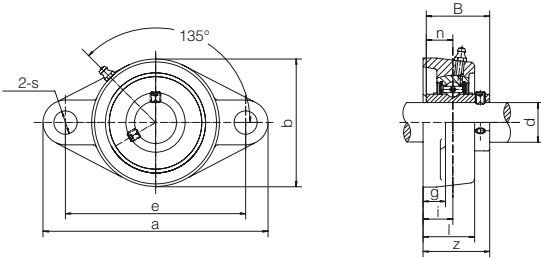

Unit number	Dimensions (mm)										
	d	a	e	i	g	l	s	b	z	B	n
UCFL201D1	12	113	90	15	11	25.5	12	60	33.3	31.0	12.7
UCFL202D1	15	113	90	15	11	25.5	12	60	33.3	31.0	12.7
UCFL203D1	17	113	90	15	11	25.5	12	60	33.3	31.0	12.7
UCFL204D1	20	113	90	15	11	25.5	12	60	33.3	31.0	12.7
UCFL205D1	25	130	99	16	13	27	16	68	35.8	34.1	14.3
UCFL206D1	30	148	117	18	13	31	16	80	40.2	38.1	15.9
UCFL207D1	35	161	130	19	14	34	16	90	44.4	42.9	17.5
UCFL208D1	40	175	144	21	14	36	16	100	51.2	49.2	19.0
UCFL209D1	45	188	148	22	15	38	19	108	52.2	49.2	19.0
UCFL210D1	50	197	157	22	15	40	19	115	54.6	51.6	19.0
UCFL211D1	55	224	184	25	18	43	19	130	58.4	55.6	22.2
UCFL212D1	60	250	202	29	18	48	23	140	68.7	65.1	25.4
UCFL213D1	65	258	210	30	22	50	23	155	69.7	65.1	25.4
UCFL214D1	70	265	216	31	22	54	23	160	75.4	74.6	30.2
UCFL215D1	75	275	225	34	22	56	23	165	78.5	77.8	33.3
UCFL216D1	80	290	233	34	22	58	25	180	83.3	82.6	33.3
UCFL217D1	85	305	248	36	24	63	25	190	87.5	85.7	34.1
UCFL218D1	90	320	265	40	24	68	25	205	96.3	96.0	39.7

Bolt size (mm)	Bearing number	Housing number	Weight (kg)
M10	UC201D1	FL201D1	0.45
M10	UC202D1	FL202D1	0.44
M10	UC203D1	FL203D1	0.43
M10	UC204D1	FL204D1	0.40
M14	UC205D1	FL205D1	0.58
M14	UC206D1	FL206D1	0.83
M14	UC207D1	FL207D1	1.10
M14	UC208D1	FL208D1	1.42
M16	UC209D1	FL209D1	1.75
M16	UC210D1	FL210D1	2.02
M16	UC211D1	FL211D1	2.79
M20	UC212D1	FL212D1	3.65
M20	UC213D1	FL213D1	4.56
M20	UC214D1	FL214D1	5.12
M20	UC215D1	FL215D1	5.64
M22	UC216D1	FL216D1	6.91
M22	UC217D1	FL217D1	8.27
M22	UC218D1	FL218D1	10.13

Flange Cartridge Units (Oval) UELFL2

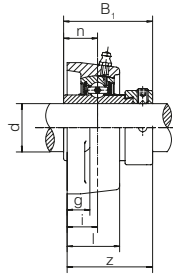
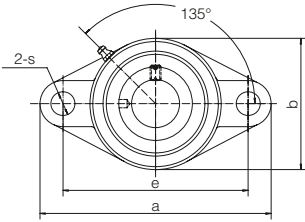

Unit number	Dimensions (mm)										
	d	a	e	i	g	l	s	b	z	B ₁	n
UELFL204D1	20	113	90	15	11	25.5	12	60	41.6	43.7	17.1
UELFL205D1	25	130	99	16	13	27	16	68	42.9	44.4	17.5
UELFL206D1	30	148	117	18	13	31	16	80	48.1	48.4	18.3
UELFL207D1	35	161	130	19	14	34	16	90	51.3	51.1	18.8
UELFL208D1	40	175	144.0	21	14	36	16	100	55.9	56.3	21.4
UELFL209D1	45	188	148	22	15	38	19	108	56.9	56.3	21.4
UELFL210D1	50	197	157	22	15	40	19	115	60.1	62.7	24.6
UELFL211D1	55	224	184	25	18	43	19	130	68.6	71.4	27.8
UELFL212D1	60	250	202	29	18	48	23	140	75.8	77.8	31
UELFL213D1	65	258	210	30	22	50	23	155	81.6	85.7	34.1
UELFL214D1	70	265	216	31	22	54	23	160	82.6	85.7	34.1
UELFL215D1	75	275	225	34	22	56	23	165	88.8	92.1	37.3

Bolt size (mm)	Bearing number	Housing number	Weight (kg)
M10	UEL204D1	FL204D1	0.46
M14	UEL205D1	FL205D1	0.63
M14	UEL206D1	FL206D1	0.90
M14	UEL207D1	FL207D1	1.24
M14	UEL208D1	FL208D1	1.56
M16	UEL209D1	FL209D1	1.88
M16	UEL210D1	FL210D1	2.21
M16	UEL211D1	FL211D1	3.06
M20	UEL212D1	FL212D1	3.97
M20	UEL213D1	FL213D1	5.10
M20	UEL214D1	FL214D1	5.53
M20	UEL215D1	FL215D1	6.09

Flange Cartridge Units (Oval) UKFL2

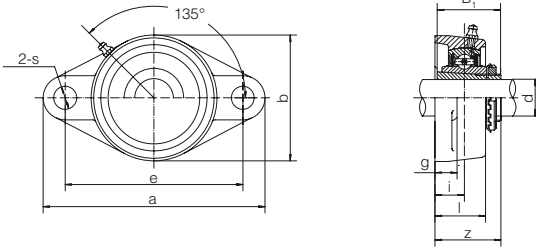

Unit number	Dimensions (mm)									
	d	a	e	i	g	l	s	b	z	B ₁
UKFL205D1+H2305	20	130	99	16	13	27	16	68	35.5	35
UKFL206D1+H2306	25	148	117	18	13	31	16	80	39	38
UKFL207D1+H2307	30	161	130	19	14	34	16	90	42.5	43
UKFL208D1+H2308	35	175	144	21	14	36	16	100	46.5	46
UKFL209D1+H2309	40	188	148	22	15	38	19	108	48.5	50
UKFL210D1+H2310	45	197	157	22	15	40	19	115	50	55
UKFL211D1+H2311	50	224	184	25	18	43	19	130	54.5	59
UKFL212D1+H2312	55	250	202	29	18	48	23	140	61	62
UKFL213D1+H2313	60	258	210	30	22	50	23	155	64	65
UKFL215D1+H2315	65	275	225	34	22	56	23	165	71	73
UKFL216D1+H2316	70	290	233	34	22	58	25	180	73.5	78
UKFL217D1+H2317	75	305	248	36	24	63	25	190	77	82
UKFL218D1+H2318	80	320	265	40	24	68	25	205	81.5	86

Bolt size (mm)	Bearing number	Housing number	Weight (kg)
M14	UK205D1+H2305	FL205D1	0.63
M14	UK206D1+H2306	FL206D1	0.89
M14	UK207D1+H2307	FL207D1	1.17
M14	UK208D1+H2308	FL208D1	1.49
M16	UK209D1+H2309	FL209D1	1.87
M16	UK210D1+H2310	FL210D1	2.19
M16	UK211D1+H2311	FL211D1	2.95
M20	UK212D1+H2312	FL212D1	3.73
M20	UK213D1+H2313	FL213D1	4.67
M20	UK215D1+H2315	FL215D1	6.00
M22	UK216D1+H2316	FL216D1	7.34
M22	UK217D1+H2317	FL217D1	8.68
M22	UK218D1+H2318	FL218D1	10.43

Take-up Units UCT2

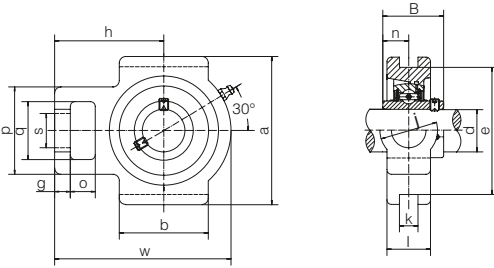

Unit number	Dimensions (mm)															
	d	o	g	p	q	s	b	k	e	a	w	j	l	h	B	n
UCT201D1	12	16	10	51	32	19	51	12	76	89	94	32	21	61	31	12.7
UCT202D1	15	16	10	51	32	19	51	12	76	89	94	32	21	61	31	12.7
UCT203D1	17	16	10	51	32	19	51	12	76	89	94	32	21	61	31	12.7
UCT204D1	20	16	10	51	32	19	51	12	76	89	94	32	21	61	31	12.7
UCT205D1	25	16	10	51	32	19	51	12	76	89	97	32	24	62	34.1	14.3
UCT206D1	30	16	10	56	37	22	57	12	89	102	113	37	28	70	38.1	15.9
UCT207D1	35	16	13	64	37	22	64	12	89	102	129	37	30	78	42.9	17.5
UCT208D1	40	19	16	83	49	29	83	16	102	114	144	49	33	89	49.2	19
UCT209D1	45	19	16	83	49	29	83	16	102	117	144	49	35	87	49.2	19
UCT210D1	50	19	16	83	49	29	86	16	102	117	149	49	37	90	51.6	19
UCT211D1	55	25	19	102	64	35	95	22	130	146	171	64	38	106	55.6	22.2
UCT212D1	60	32	19	102	64	35	102	22	130	146	194	64	42	119	65.1	25.4
UCT213D1	65	32	21	111	70	41	121	26	151	167	224	70	44	137	65.1	25.4
UCT214D1	70	32	21	111	70	41	121	26	151	167	224	70	46	137	74.6	30.2
UCT215D1	75	32	21	111	70	41	121	26	151	167	232	70	48	140	77.8	33.3
UCT216D1	80	32	21	111	70	41	121	26	165	184	235	70	51	140	82.6	33.3
UCT217D1	85	38	29	124	73	48	157	30	173	198	260	73	54	162	85.7	34.1

Bearing number	Housing number	Weight (kg)
UC201D1	T201D1	0.77
UC202D1	T202D1	0.76
UC203D1	T203D1	0.75
UC204D1	T204D1	0.73
UC205D1	T205D1	0.80
UC206D1	T206D1	1.22
UC207D1	T207D1	1.57
UC208D1	T208D1	2.31
UC209D1	T209D1	2.34
UC210D1	T210D1	2.47
UC211D1	T211D1	3.74
UC212D1	T212D1	4.58
UC213D1	T213D1	6.60
UC214D1	T214D1	6.74
UC215D1	T215D1	7.19
UC216D1	T216D1	8.08
UC217D1	T217D1	10.66

Take-up Units

UELT2

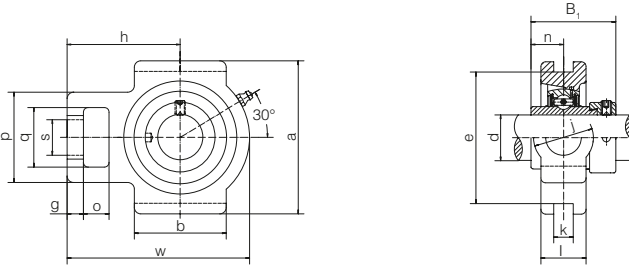

Unit number	Dimensions (mm)															
	d	o	g	p	q	s	b	k	e	a	w	j	l	h	B ₁	n
UELT204D1	20	16	10	51	32	19	51	12	76	89	94	32	21	61	43.7	17.1
UELT205D1	25	16	10	51	32	19	51	12	76	89	97	32	24	62	44.4	17.5
UELT206D1	30	16	10	56	37	22	57	12	89	102	113	37	28	70	48.4	18.3
UELT207D1	35	16	13	64	37	22	64	12	89	102	129	37	30	78	51.1	18.8
UELT208D1	40	19	16	83	49	29	83	16	102	114	144	49	33	89	56.3	21.4
UELT209D1	45	19	16	83	49	29	83	16	102	117	144	49	35	87	56.3	21.4
UELT210D1	50	19	16	83	49	29	86	16	102	117	149	49	37	90	62.7	24.6
UELT211D1	55	25	19	102	64	35	95	22	130	146	171	64	38	106	71.4	27.8
UELT212D1	60	32	19	102	64	35	102	22	130	146	194	64	42	119	77.8	31
UELT213D1	65	32	21	111	70	41	121	26	151	167	224	70	44	137	85.7	34.1
UELT214D1	70	32	21	111	70	41	121	26	151	167	224	70	46	137	85.7	34.1
UELT215D1	75	32	21	111	70	41	121	26	151	167	232	70	48	140	92.1	37.3

Bearing number	Housing number	Weight (kg)
UEL204D1	T204D1	0.78
UEL205D1	T205D1	0.86
UEL206D1	T206D1	1.29
UEL207D1	T207D1	1.70
UEL208D1	T208D1	2.45
UEL209D1	T209D1	2.47
UEL210D1	T210D1	2.66
UEL211D1	T211D1	4.01
UEL212D1	T212D1	4.90
UEL213D1	T213D1	7.14
UEL214D1	T214D1	7.15
UEL215D1	T215D1	7.67

Take-up Units UKT2

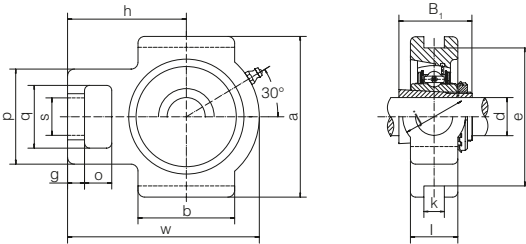

Unit number	Dimensions (mm)														
	d	o	g	p	q	s	b	k	e	a	w	j	l	h	B ₁
UKT205D1+H2305	20	16	10	51	32	19	51	12	76	89	97	32	24	62	35
UKT206D1+H2306	25	16	10	56	37	22	57	12	89	102	113	37	28	70	38
UKT207D1+H2307	30	16	13	64	37	22	64	12	89	102	129	37	30	78	43
UKT208D1+H2308	35	19	16	83	49	29	83	16	102	114	144	49	33	89	46
UKT209D1+H2309	40	19	16	83	49	29	83	16	102	117	144	49	35	87	50
UKT210D1+H2310	45	19	16	83	49	29	86	16	102	117	149	49	37	90	55
UKT211D1+H2311	50	25	19	102	64	35	95	22	130	146	171	64	38	106	59
UKT212D1+H2312	55	32	19	102	64	35	102	22	130	146	194	64	42	119	62
UKT213D1+H2313	60	32	21	111	70	41	121	26	151	167	224	70	44	137	65
UKT215D1+H2315	65	32	21	111	70	41	121	26	151	167	232	70	48	140	73
UKT216D1+H2316	70	32	21	111	70	41	121	26	165	184	235	70	51	140	78
UKT217D1+H2317	75	38	29	124	73	48	157	30	173	198	260	73	54	162	82

Bearing number	Housing number	Weight (kg)
UK205D1+H2305	T205D1	0.86
UK206D1+H2306	T206D1	1.26
UK207D1+H2307	T207D1	2.50
UK208D1+H2308	T208D1	2.50
UK209D1+H2309	T209D1	2.51
UK210D1+H2310	T210D1	2.60
UK211D1+H2311	T211D1	4.26
UK212D1+H2312	T212D1	5.02
UK213D1+H2313	T213D1	6.56
UK215D1+H2315	T215D1	7.52
UK216D1+H2316	T216D1	8.56
UK217D1+H2317	T217D1	11.38

Pillow Block Units

UCUP2

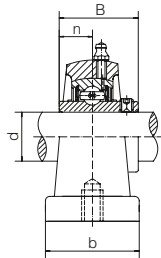
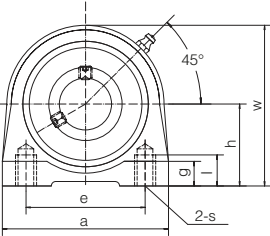

Unit number	Dimensions (mm)										
	d	h	a	e	b	s	g	l	w	B	n
UCUP201D1	12	30.2	76	52	40	M10	11	15	62	31	12.7
UCUP202D1	15	30.2	76	52	40	M10	11	15	62	31	12.7
UCUP203D1	17	30.2	76	52	40	M10	11	15	62	31	12.7
UCUP204D1	20	30.2	76	52	40	M10	11	15	62	31	12.7
UCUP205D1	25	36.5	84	56	38	M10	12	15	72	34.1	14.3
UCUP206D1	30	42.9	94	66	50	M14	12	18	84	38.1	15.9
UCUP207D1	35	47.6	110	80	55	M14	13	20	95	42.9	17.5
UCUP208D1	40	49.2	116	84	58	M14	13	20	100	49.2	19
UCUP209D1	45	54.2	120	90	60	M14	13	25	108	49.2	19
UCUP210D1	50	57.2	130	94	64	M16	14	25	116	51.6	19
UCUP211D1	55	63.5	140	104	66	M16	14	25	125	55.6	22.2
UCUP212D1	60	69.9	150	114	68	M16	15	25	138	65.1	25.4

Bolt size (mm)	Bearing number	Housing number	Weight (kg)
M10	UC201D1	UP201D1	0.63
M10	UC202D1	UP202D1	0.62
M10	UC203D1	UP203D1	0.61
M10	UC204D1	UP204D1	0.59
M10	UC205D1	UP205D1	0.76
M14	UC206D1	UP206D1	1.12
M14	UC207D1	UP207D1	1.55
M14	UC208D1	UP208D1	1.80
M14	UC209D1	UP209D1	2.05
M16	UC210D1	UP210D1	2.56
M16	UC211D1	UP211D1	3.14
M16	UC212D1	UP212D1	4.12

Pillow Block Units

UELUP2

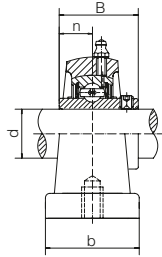
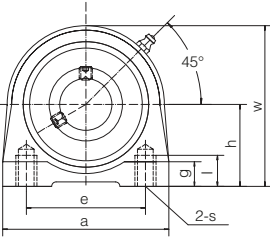

Unit number	Dimensions (mm)										
	d	h	a	e	b	s	g	l	w	B	n
UELUP204D1	20	30.2	76	52	40	M10	11	15	62	43.7	17.1
UELUP205D1	25	36.5	84	56	38	M10	12	15	72	44.4	17.5
UELUP206D1	30	42.9	94	66	50	M14	12	18	84	48.4	18.3
UELUP207D1	35	47.6	110	80	55	M14	13	20	95	51.1	18.8
UELUP208D1	40	49.2	116	84	58	M14	13	20	100	56.3	21.4
UELUP209D1	45	54.2	120	90	60	M14	13	25	108	56.3	21.4
UELUP210D1	50	57.2	130	94	64	M16	14	25	116	62.7	24.6
UELUP211D1	55	63.5	140	104	66	M16	14	25	125	71.4	27.8
UELUP212D1	60	69.9	150	114	68	M16	15	25	138	77.8	31.0

Bolt size (mm)	Bearing number	Housing number	Weight (kg)
M10	UEL204D1	UP204D1	0.64
M10	UEL205D1	UP205D1	0.81
M14	UEL206D1	UP206D1	1.19
M14	UEL207D1	UP207D1	1.68
M14	UEL208D1	UP208D1	1.93
M14	UEL209D1	UP209D1	2.18
M16	UEL210D1	UP210D1	2.75
M16	UEL211D1	UP211D1	3.41
M16	UEL212D1	UP212D1	4.44

Pillow Block Units

UKUP2

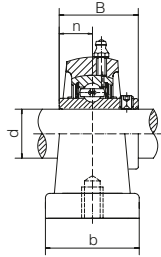
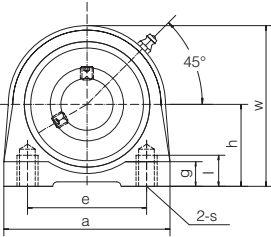

Unit number	Dimensions (mm)									
	d	h	a	e	b	s	g	l	w	B
UKUP205D1+H2305	20	36.5	84	56	38	M10	12	15	72	35
UKUP206D1+H2306	25	42.9	94	66	50	M14	12	18	84	38
UKUP207D1+H2307	30	47.6	110	80	55	M14	13	20	95	43
UKUP208D1+H2308	35	49.2	116	84	58	M14	13	20	100	46
UKUP209D1+H2309	40	54.2	120	90	60	M14	13	25	108	50
UKUP210D1+H2310	45	57.2	130	94	64	M16	14	25	116	55
UKUP211D1+H2311	50	63.5	140	104	66	M16	14	25	125	59
UKUP212D1+H2312	55	69.9	150	114	68	M16	15	25	138	62

Bolt size (mm)	Bearing number	Housing number	Weight (kg)
M10	UK205D1+H2305	UP205D1	0.80
M14	UK206D1+H2306	UP206D1	1.18
M14	UK207D1+H2307	UP207D1	1.62
M14	UK208D1+H2308	UP208D1	1.87
M14	UK209D1+H2309	UP209D1	2.17
M16	UK210D1+H2310	UP210D1	2.73
M16	UK211D1+H2311	UP211D1	3.30
M16	UK212D1+H2312	UP212D1	4.20

Ball Bearings

UC2

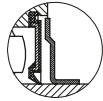
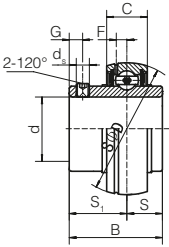

SL Dual seal
(Standard)

Unit number	Dimensions (mm)								
	d	D	B	C	S	S_1	G	D_2	F
UC201D1	12	47	31	17	12.7	18.3	4.8	M6x1	4.3
UC202D1	15	47	31	17	12.7	18.3	4.8	M6x1	4.3
UC203D1	17	47	31	17	12.7	18.3	4.8	M6x1	4.3
UC204D1	20	47	31	17	12.7	18.3	4.8	M6x1	4.3
UC205D1	25	52	34.1	17	14.3	19.8	5	M6x1	4.3
UC206D1	30	62	38.1	19	15.9	22.2	5	M6x1	5.2
UC207D1	35	72	42.9	20	17.5	25.4	7	M8x1	5.7
UC208D1	40	80	49.2	21	19	30.2	8	M8x1	6.2
UC209D1	45	85	49.2	22	19	30.2	8	M8x1	6.6
UC210D1	50	90	51.6	24	19	32.6	10	M10x1	6.5
UC211D1	55	100	55.6	25	22.2	33.4	10	M10x1	7.1
UC212D1	60	110	65.1	27	25.4	39.7	10	M10x1	7.9
UC213D1	65	120	65.1	28	25.4	39.7	10	M10x1	8.0
UC214D1	70	125	74.6	29	30.2	44.4	12	M12x1.5	8.3
UC215D1	75	130	77.8	30	33.3	44.5	12	M12x1.5	8.6
UC216D1	80	140	82.6	32	33.3	49.3	12	M12x1.5	9.0
UC217D1	85	150	85.7	34	34.1	51.6	12	M12x1.5	9.8
UC218D1	90	160	96	36	39.7	56.3	12	M12x1.5	10.8

Dynamic load ratings (N) C_r	Static load ratings (N) C_{0r}	Weight (kg)
12800	6600	0.20
12800	6600	0.19
12800	6600	0.18
12800	6600	0.16
14000	7850	0.19
19450	11250	0.30
25700	15200	0.45
29500	18100	0.60
32700	20900	0.65
35000	23200	0.75
43300	29200	0.99
47700	32800	1.32
57200	40000	1.70
62100	44800	1.94
66200	49300	2.16
72600	53300	2.65
83300	63700	3.29
96000	71100	4.04

Ball Bearings

UEL2

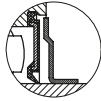
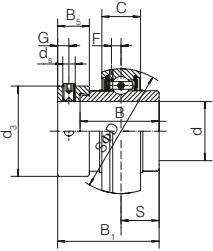

SL Dual seal
(Standard)

Unit number	Dimensions (mm)										
	d	D	B ₁	B	C	S	d _s	G	B ₂	d ₃	F
UEL204D1	20	47	43.7	34.2	17	17.1	M6x1	4.8	13.5	33.3	3.4
UEL205D1	25	52	44.4	34.9	17	17.5	M6x1	4.8	13.5	38.1	4.3
UEL206D1	30	62	48.4	36.5	19	18.3	M8x1	6	15.9	44.5	5.2
UEL207D1	35	72	51.1	37.6	20	18.8	M8x1	6.8	17.5	55.6	5.7
UEL208D1	40	80	56.3	42.8	21	21.4	M8x1	6.8	18.3	60.3	6.2
UEL209D1	45	85	56.3	42.8	22	21.4	M8x1	6.8	18.3	63.5	6.6
UEL210D1	50	90	62.7	49.2	24	24.6	M8x1	6.8	18.3	69.9	6.5
UEL211D1	55	100	71.4	55.5	25	27.8	M10x1	8	20.7	76.2	7.1
UEL212D1	60	110	77.8	61.9	27	31	M10x1	8	22.3	84.2	7.9
UEL213D1	65	120	85.7	68.6	28	34.1	M10x1	8.5	23.5	92	8.0
UEL214D1	70	125	85.7	68.6	29	34.1	M10x1	8.5	23.5	97	8.3
UEL215D1	75	130	92.1	75	30	37.3	M10x1	8.5	23.5	102	8.6

Dynamic load ratings (N) C_r	Static load ratings (N) C_{or}	Weight (kg)
12800	6600	0.21
14000	7850	0.25
19450	11250	0.37
25700	15200	0.58
29500	18100	0.73
32700	20900	0.78
35000	23200	0.94
43300	29200	1.26
47700	32800	1.71
57200	40000	2.24
62100	44800	2.35
66200	49300	2.64

Ball Bearings UK2

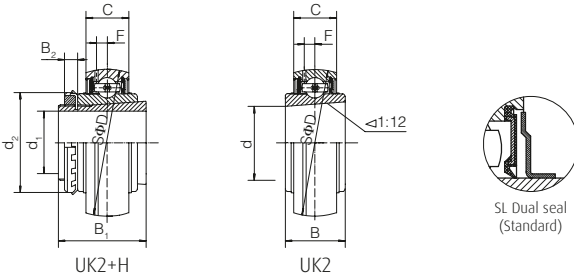

Unit number	Dimensions (mm)								
	d_1	d	D	B	C	B_1	B_2	d_2	F
UK205D1+H2305	20	25	52	23	17	35	8	38	4.3
UK206D1+H2306	25	30	62	26	19	38	8	45	5.2
UK207D1+H2307	30	35	72	29	20	43	9	52	5.7
UK208D1+H2308	35	40	80	31	21	46	10	58	6.2
UK209D1+H2309	40	45	85	31	22	50	11	65	6.6
UK210D1+H2310	45	50	90	32	24	55	12	70	6.5
UK211D1+H2311	50	55	100	35	25	59	12	75	7.1
UK212D1+H2312	55	60	110	38	27	62	13	80	7.9
UK213D1+H2313	60	65	120	40	28	65	14	85	8.0
UK215D1+H2315	65	75	130	44	30	73	15	98	8.6
UK216D1+H2316	70	80	140	45	32	78	17	105	9
UK217D1+H2317	75	85	150	46	34	82	18	110	9.8
UK218D1+H2318	80	90	160	47	36	86	18	120	10.8

Dynamic load ratings (N) C_r	Static load ratings (N) C_{0r}	Weight (kg)
14000	7850	0.24
19450	11250	0.36
25700	15200	0.52
29500	18100	0.67
32700	20900	0.77
35000	23200	0.92
43300	29200	1.15
47700	32800	1.47
57200	40000	1.81
66200	49300	2.55
72600	53300	3.08
83300	63700	3.70
96000	71100	4.34

Ball Bearings

AEL2

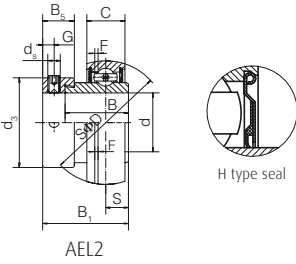

Unit number	Dimensions (mm)										
	d	D	B ₁	B	C	S	d ₁	G	B ₅	d ₃	F
AEL201D1	12	40	28.6	19.1	12	6.5	M6X1	4.8	13.5	28.6	4.3
AEL202D1	15	40	28.6	19.1	12	6.5	M6X1	4.8	13.5	28.6	4.3
AEL203D1	17	40	28.6	19.1	12	6.5	M6X1	4.8	13.5	28.6	4.3
AEL204D1	20	47	31.0	21.5	14	7.5	M6X1	4.8	13.5	33.3	4.3
AEL205D1	25	52	31	21.5	15	7.5	M6X1	4.8	13.5	38.1	4.3
AEL206D1	30	62	35.7	23.8	16	9.0	M8X1	6	15.9	44.5	5.2
AEL207D1	35	72	38.9	25.4	17	9.5	M8X1	6.8	17.5	55.6	5.7
AEL208D1	40	80	43.7	30.2	18	11.0	M8X1	6.8	18.3	60.3	6.2
AEL209D1	45	85	43.7	30.2	19	11.0	M8X1	6.8	18.3	63.5	6.6
AEL210D1	50	90	43.7	30.2	20	11.0	M8X1	6.8	18.3	69.9	6.5
AEL211D1	55	100	48.4	32.5	21	12.0	M10X1	8	20.7	76.2	7.1
AEL212D1	60	110	53.1	37.2	22	13.5	M10X1	8	22.3	84.2	7.9

Dynamic load ratings (N) C_r	Static load ratings (N) C_{0r}	Weight (kg)
7360	4480	0.14
7360	4480	0.12
7360	4480	0.11
12800	6600	0.17
14000	7850	0.20
19450	11250	0.30
25700	15200	0.48
29500	18100	0.63
32700	20900	0.66
35000	23200	0.75
43300	29200	1.00
47700	32800	1.34

Ball Bearings

AS2

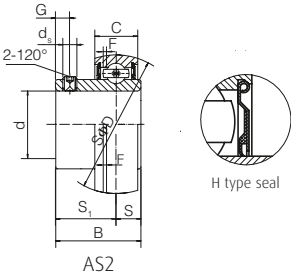

Unit number	Dimensions (mm)								
	d	D	B	C	S	S ₁	d ₁	G	F
AS201D1	12	40	22.0	12	6.0	16.0	M5X0.8	4.5	4.3
AS202D1	15	40	22	12	6.0	16.0	M5X0.8	4.5	4.3
AS203D1	17	40	22.0	12	6.0	16.0	M5X0.8	4.5	4.3
AS204D1	20	47	25.0	14	7.0	18.0	M6X1	4.5	4.3
AS205D1	25	52	27	15	7.5	19.5	M6X1	5.5	4.3
AS206D1	30	62	30	16	8.0	22.0	M6X1	6	5.2
AS207D1	35	72	32	17	8.5	23.5	M8X1	6.5	5.7
AS208D1	40	80	34	18	9.0	25.0	M8X1	7	6.2
AS209D1	45	85	41.2	19	10.2	31.0	M8X1	8.2	6.6
AS210D1	50	90	43.5	20	10.9	32.6	M10X1	9.2	6.5

Dynamic load ratings (N) C_r	Static load ratings (N) C_{or}	Weight (kg)
7360	4480	0.11
7360	4480	0.10
7360	4480	0.09
12800	6600	0.14
14000	7850	0.17
19450	11250	0.26
25700	15200	0.38
29500	18100	0.48
32700	20900	0.57
35000	23200	0.65

Pressed steel pillow block units (zinc plated housings) ASPP2

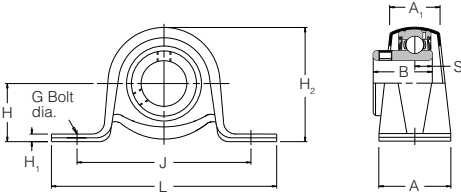

ASPP2

Unit number	Dimensions (mm)										
	Shaft diameter	L	H	H ₁	H ₂	J	G	A	A ₁	B	S
ASPP201	12	85.7	22.2	2.4	43.2	68.0	8	25.4	15.9	22	6.0
ASPP202	15	85.7	22.2	2.4	43.2	68.0	8	25.4	15.9	22	6.0
ASPP203	17	85.7	22.2	2.4	43.2	68.0	8	25.4	15.9	22	6.0
ASPP204	20	98.4	25.4	2.4	49.9	76.0	8	31.7	21.6	25	7.0
ASPP205	25	108.0	28.6	2.8	55.8	86.0	10	31.7	21.6	27	7.5
ASPP206	30	117.5	33.3	3.6	65.7	95.0	10	37.5	25.5	30	8.0
ASPP207	35	128.6	39.7	4.4	77.5	106.0	10	41.0	28.4	32	8.5

Bearing number	Housing number	Max. radial housing load (N)	Rec. max. speed (min ⁻¹)	Mass (approx.) (kg)
AS201	PP203	1330	3000	0.2
AS202	PP203	1330	3000	0.2
AS203	PP203	1330	3000	0.2
AS204	PP204	1570	3000	0.2
AS205	PP205	1780	2500	0.3
AS206	PP206	2670	2500	0.5
AS207	PP207	3560	2000	0.9

Pressed steel pillow block units (zinc plated housings) AELPP2

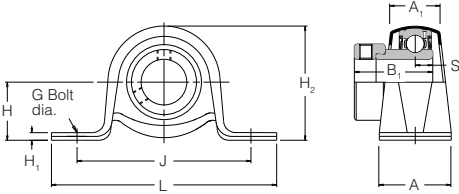

Unit number	Dimensions (mm)										
	Shaft diameter	L	H	H ₁	H ₂	J	G	A	A ₁	B ₁	S
AELPP201	12	85.7	22.2	2.4	43.2	68.0	8	25.4	15.9	28.6	6.5
AELPP202	15	85.7	22.2	2.4	43.2	68.0	8	25.4	15.9	28.6	6.5
AELPP203	17	85.7	22.2	2.4	43.2	68.0	8	25.4	15.9	28.6	6.5
AELPP204	20	98.4	25.4	2.4	49.9	76.0	8	31.7	21.6	31.0	7.5
AELPP205	25	108.0	28.6	2.8	55.8	86.0	10	31.7	21.6	31	7.5
AELPP206	30	117.5	33.3	3.6	65.7	95.0	10	37.5	25.5	35.7	9.0
AELPP207	35	128.6	39.7	4.4	77.5	106.0	10	41.0	28.4	38.9	9.5

Bearing number	Housing number	Max. radial housing load (N)	Rec. max. speed (min ⁻¹)	Mass (approx.) (kg)
AEL201	PP203	1330	3000	0.2
AEL202	PP203	1330	3000	0.2
AEL203	PP203	1330	3000	0.2
AEL204	PP204	1570	3000	0.2
AEL205	PP205	1780	2500	0.3
AEL206	PP206	2670	2500	0.5
AEL207	PP207	3560	2000	0.9

Pressed steel flange bearing units (zinc plated housings) ASPFL2

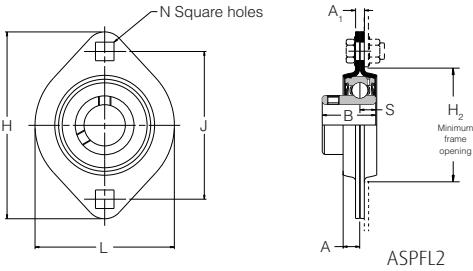

Unit number	Dimensions (mm)									
	Shaft diameter	L	H	H ₂	J	N	A	A ₁	B	S
ASPFL201	12	58.7	81.0	49.0	63.5	7.1	6.7	4.0	22	6.0
ASPFL202	15	58.7	81.0	49.0	63.5	7.1	6.7	4.0	22	6.0
ASPFL203	17	58.7	81.0	49.0	63.5	7.1	6.7	4.0	22	6.0
ASPFL204	20	66.7	90.5	55.0	71.5	8.7	7.7	4.0	25	7.0
ASPFL205	25	71.0	95.3	60.0	76.0	8.7	8.7	4.0	27	7.5
ASPFL206	30	84.1	112.7	71.0	90.5	10.5	9.0	5.0	30	8.0
ASPFL207	35	93.6	122.6	81.0	100.0	10.5	10.0	5.0	32	8.5

Bearing number	Housing number	Max. radial housing load (N)	Rec. max. speed (min ⁻¹)	Mass (approx.) (kg)
AS201	PFL203	2670	3000	0.2
AS202	PFL203	2670	3000	0.2
AS203	PFL203	2670	3000	0.2
AS204	PFL204	3110	3000	0.3
AS205	PFL205	3560	2500	0.3
AS206	PFL206	4890	2500	0.5
AS207	PFL207	6250	2000	0.7

Pressed steel flange bearing units (zinc plated housings)

AELPFL2

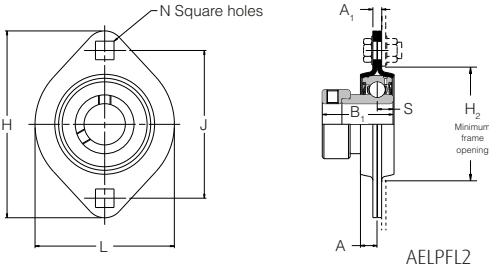

Unit number	Dimensions (mm)									
	Shaft diameter	L	H	H ₂	J	N	A	A ₁	B ₁	S
AELPFL201	12	58.7	81.0	49.0	63.5	7.1	6.7	4.0	28.6	6.5
AELPFL202	15	58.7	81.0	49.0	63.5	7.1	6.7	4.0	28.6	6.5
AELPFL203	17	58.7	81.0	49.0	63.5	7.1	6.7	4.0	28.6	6.5
AELPFL204	20	66.7	90.5	55.0	71.5	8.7	7.7	4.0	31.0	7.5
AELPFL205	25	71.0	95.3	60.0	76.0	8.7	8.7	4.0	31	7.5
AELPFL206	30	84.1	112.7	71.0	90.5	10.5	9.0	5.0	35.7	9.0
AELPFL207	35	93.6	122.6	81.0	100.0	10.5	10.0	5.0	38.9	9.5

Bearing number	Housing number	Max. radial housing load (N)	Rec. max. speed (min ⁻¹)	Mass (approx.) (kg)
AEL201	PFL203	2670	3000	0.2
AEL202	PFL203	2670	3000	0.2
AEL203	PFL203	2670	3000	0.2
AEL204	PFL204	3110	3000	0.3
AEL205	PFL205	3560	2500	0.3
AEL206	PFL206	4890	2500	0.5
AEL207	PFL207	6250	2000	0.7

Pressed steel flange bearing units (zinc plated housings) ASPF2

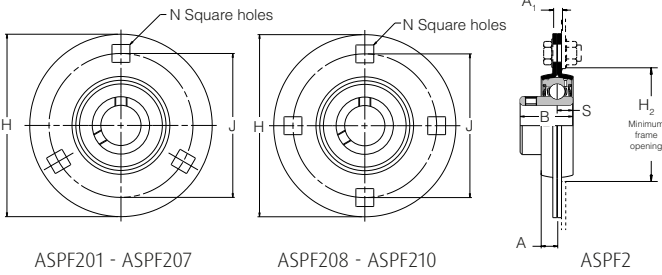

Unit number	Dimensions (mm)								
	Shaft diameter	H	H ₂	J	N	A	A ₁	B	S
ASPF201	12	81.0	49.0	63.5	7.1	6.7	4.0	22	6.0
ASPF202	15	81.0	49.0	63.5	7.1	6.7	4.0	22	6.0
ASPF203	17	81.0	49.0	63.5	7.1	6.7	4.0	22	6.0
ASPF204	20	90.5	55.0	71.5	8.7	7.7	4.0	25	7.0
ASPF205	25	95.2	60.0	76.0	8.7	8.7	4.0	27	7.5
ASPF206	30	112.7	71.0	90.5	10.5	9.0	5.0	30	8.0
ASPF207	35	122.2	81.0	100.0	10.5	10.0	5.0	32	8.5
ASPF208	40	147.8	91.0	119.0	13.5	10.0	7.0	34	9.0
ASPF209	45	149.2	97.0	120.5	13.5	10.0	7.0	41.2	10.2
ASPF210	50	155.6	102.0	127.0	13.5	10.5	8.0	43.5	10.9

Bearing number	Housing number	Max. radial housing load (N)	Rec. max. speed (min ⁻¹)	Mass (approx.) (kg)
AS201	PF203	2670	3000	0.2
AS202	PF203	2670	3000	0.2
AS203	PF203	2670	3000	0.2
AS204	PF204	3110	3000	0.3
AS205	PF205	3560	2500	0.4
AS206	PF206	4890	2500	0.7
AS207	PF207	6250	2000	0.9
AS208	PF208	7550	2000	1.5
AS209	PF209	7550	2000	1.6
AS210	PF210	8450	1500	1.8

Pressed steel flange bearing units (zinc plated housings) AELPF2

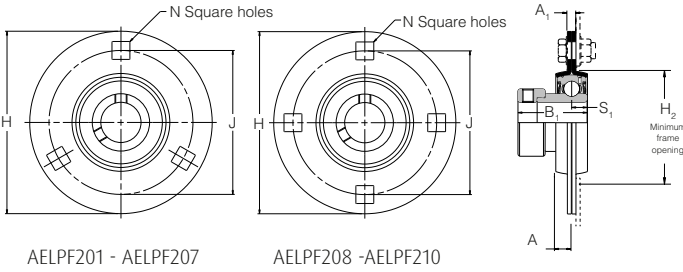

AELPF201 - AELPF207

AELPF208 -AELPF210

Unit number	Dimensions (mm)								
	Shaft diameter	H	H2	J	N	A	A1	B1	S
AELPF201	12	81.0	49.0	63.5	7.1	6.7	4.0	28.6	6.5
AELPF202	15	81.0	49.0	63.5	7.1	6.7	4.0	28.6	6.5
AELPF203	17	81.0	49.0	63.5	7.1	6.7	4.0	28.6	6.5
AELPF204	20	90.5	55.0	71.5	8.7	7.7	4.0	31.0	7.5
AELPF205	25	95.2	60.0	76.0	8.7	8.7	4.0	31.0	7.5
AELPF206	30	112.7	71.0	90.5	10.5	9.0	5.0	35.7	9.0
AELPF207	35	122.2	81.0	100.0	10.5	10.0	5.0	38.9	9.5
AELPF208	40	147.8	91.0	119.0	13.5	10.0	7.0	43.7	11.0
AELPF209	45	149.2	97.0	120.5	13.5	10.0	7.0	43.7	11.0
AELPF210	50	155.6	102.0	127.0	13.5	10.5	8.0	43.7	11.0

Bearing number	Housing number	Max. radial housing load (N)	Rec. max. speed (min ⁻¹)	Mass (approx.) (kg)
AEL201	PF203	2670	3000	0.2
AEL202	PF203	2670	3000	0.2
AEL203	PF203	2670	3000	0.2
AEL204	PF204	3110	3000	0.3
AEL205	PF205	3560	2500	0.4
AEL206	PF206	4890	2500	0.7
AEL207	PF207	6250	2000	0.9
AEL208	PF208	7550	2000	1.5
AEL209	PF209	7550	2000	1.6
AEL210	PF210	8450	1500	1.8

NSK Sales Offices – Europe, Middle East and Africa

UK

NSK UK Ltd.
Northern Road, Newark
Nottinghamshire NG24 2JF
Tel. +44 (0) 1636 605123
Fax +44 (0) 1636 643276
info-uk@nsk.com

France

NSK France S.A.S.
Quartier de l'Europe
2, rue Georges Guynemer
78283 Guyancourt Cedex
Tel. +33 (0) 1 30573939
Fax +33 (0) 1 30570001
info-fr@nsk.com

Germany, Austria, Switzerland, Benelux, Nordic

NSK Deutschland GmbH
Harkortstraße 15
40880 Ratingen
Tel. +49 (0) 2102 4810
Fax +49 (0) 2102 4812290
info-de@nsk.com

Italy

NSK Italia S.p.A.
Via Garibaldi, 215
20024 Garbagnate
Milanese (MI)
Tel. +39 02 995 191
Fax +39 02 990 25 778
info-it@nsk.com

Middle East

NSK Bearings Gulf Trading Co.
JAFZA View 19, Floor 24 Office 2/3
Jebel Ali Downtown,
PO Box 262163
Dubai, UAE
Tel. +971 (0) 4 804 8205
Fax +971 (0) 4 884 7227
info-me@nsk.com

Poland & CEE

NSK Polska Sp. z o.o.
Warsaw Branch
Ul. Migdałowa 4/73
02-796 Warszawa
Tel. +48 22 645 15 25
Fax +48 22 645 15 29
info-pl@nsk.com

Russia

NSK Polska Sp. z o.o.
Russian Branch
Office 1 703, Bldg 29,
18th Line of Vasilievskiy Ostrov,
Saint-Petersburg, 199178
Tel. +7 812 3325071
Fax +7 812 3325072
info-ru@nsk.com

South Africa

NSK South Africa (Pty) Ltd.
27 Galaxy Avenue
Linbro Business Park
Sandton 2146
Tel. +27 (011) 458 3600
Fax +27 (011) 458 3608
nsk-sa@nsk.com

Spain

NSK Spain, S.A.
C/ Tarragona, 161 Cuerdo Bajo
2^a Planta, 08014 Barcelona
Tel. +34 93 2892763
Fax +34 93 4335776
info-es@nsk.com

Turkey

NSK Rulmanları Orta Doğu Tic. Ltd. Şti
Cevizli Mah. D-100 Güney Yan Yol
Kuriş Kule İş Merkezi No:2 Kat:4
34846 Cevizli - Kartal - Istanbul
Tel. +90 216 4777111
Fax +90 216 4777174
turkey@nsk.com

Please also visit our website: www.nskeurope.com | Global NSK: www.nsk.com





ویرا پرداز آروین پاسارگاد

با مدیریت خانم مهندس احمدی



جهت مشاوره

با کارشناسان فنی

با ما در ارتباط باشید



021 - 91001377



0935 125 90 98