



ویرا پرداز آروین پاسارگاد

با مدیریت خانم مهندس احمدی



جهت مشاوره

با کارشناسان فنی

با ما در ارتباط باشید



021 - 91001377



















0935 125 90 98







Ball Bearing Units



Dimension

Table

HOUSING			Page Nos.		Page Nos.		Page Nos.		Page Nos.		Page Nos.		Page Nos.
Set screw type	 UC2	B312	UCP2 B4 UCPL2 B22	UCHP2 B26 UCUP2 B30				UCF2 B42	UCFC2 B66	UCFL2 B78			
	 UC3	B318	UCP3 B10				UCF3 B48 UCFS3 B60			UCFL3 B84			
	 UCX	B324	UCPX B16				UCFX B54	UCFCX B72	UCFLX B90				
	 AS2	B328	ASPL2 B34		ASPP2 B38 ASRPP2 B40					ASFB2 B100 ASFD2 B102			
Eccentric locking collar type	 UEL2	B336	UELP2 B148 UELPL2 B158	UELHP2 B162 UELUP2 B164			UELF2 B174 UELFU2 B184	UELFC2 B194	UELFL2 B198 UELFLU2 B208				
	 UEL3	B340	UELP3 B152			UELF3 B178 UELFS3 B188			UELFL3 B202				
	 AEL2	B346	AELPL2 B166		AELPP2 B170				AELFB2 B212 AELFD2 B214				
	 JEL2	B348	JELPL2 B168		AELRPP2 B172				JELFD2 B216				
Adapter type	 UK2	B354	UKP2 B248				UKF2 B260	UKFC2 B276	UKFL2 B284				
	 UK3	B358	UKP3 B252				UKF3 B264 UKFS3 B272		UKFL3 B288				
	 UKX	B362	UKPX B256				UKFX B268	UKFCX B280	UKFLX B292				
Other bearings			AR2 B332	REL2 B350	UCS2 B366	UCS3 B370	ASS2 B374						

	Page Nos.		Page Nos.		Page Nos.		Page Nos.		Page Nos.		Page Nos.
UCFA2 B92 UCFH2 B96				UCHB2 B110	UCT2 B114	UCT2- B130 UCL2- B132 UCM2- B134	UCC2 B140				
					UCT3 B120	UCM3- B136	UCC3 B142				
					UCTX B126		UCCX B146				
	ASPF2 B104 ASRPF2 B106 ASPFL2 B108					ASPT2- B138					
					UELT2 B228		UELC2 B242				
					UELT3 B232		UELC3 B244				
	AELPF2 B218 JELPF2 B220 AELRPF2 B222 AELPFL2 B224 JELPFL2 B226					AELPT2- B238 JELPT2- B240					
					UKT2 B294		UKC2 B306				
					UKT3 B298		UKC3 B308				
					UKTX B302		UKCX B310				
UELS2 B376	UELS3 B380	AELS2 B384	JELS2 B386				CS2 B388				

Technical Data

Set screw type

Eccentric locking collar type

Adapter type

Ball bearings

Ball Bearing Units

CAT. No. E1154f

TECHNICAL DATA INDEX

	Page
1. Construction	A3
2. Design Features and Advantages	A4
2.1 Maintenance free type	A4
2.2 Relubricatable type	A4
2.3 Special sealing feature	A4
2.4 Secure fitting	A5
2.5 Self-aligning	A5
2.6 Higher rated load capacity	A5
2.7 Light weight yet strong housing	A5
2.8 Easy mounting	A5
2.9 Accurate fitting of the housing	A5
2.10 Bearing replaceability	A5
3. Tolerance	A6
3.1 Tolerances of ball bearings for the unit	A6
3.2 Tolerances of housings	A9
4. Basic Load Rating and Life	A13
4.1 Bearing life	A13
4.2 Basic rated life and basic dynamic load rating	A13
4.3 Basic static load rating	A15
4.4 Allowable static equivalent load	A15
5. Bearing Internal Clearance	A16
5.1 Bearing internal clearance	A16
5.2 Internal clearance selection	A16
5.3 Bearing internal clearance selection standards	A17
6. Lubrication	A19
6.1 Maximum permissible speed of rotation	A19
6.2 Replenishment of grease	A19
6.3 Grease fitting	A21
6.4 Standard location of the grease fitting	A22
7. Recommended Torques for Tightening Set Screws	A23

1. Construction

The **NSK** bearing unit is a combination of a radial ball bearing, seal, and a housing of high-grade cast iron or pressed steel, which comes in various shapes.

The outer surface of the bearing and the internal surface of the housing are spherical, so that the unit is self-aligning.

The inside construction of the ball bearing for the unit is such that steel balls and retainers of the same type as in series 62 and 63 of the deep groove ball bearing are used. A duplex seal consisting of a combination of an oil-proof synthetic rubber seal and a slinger is

provided on both sides.

Depending on the type, the following methods of fitting to the shaft are employed:

- (1) The inner ring is fastened onto the shaft in two places by set screws.
- (2) The inner ring has a tapered bore and is fitted to the shaft by means of an adapter.
- (3) In the eccentric locking collar system the inner ring is fastened to the shaft by means of eccentric grooves provided at the side of the inner ring and on the collar.

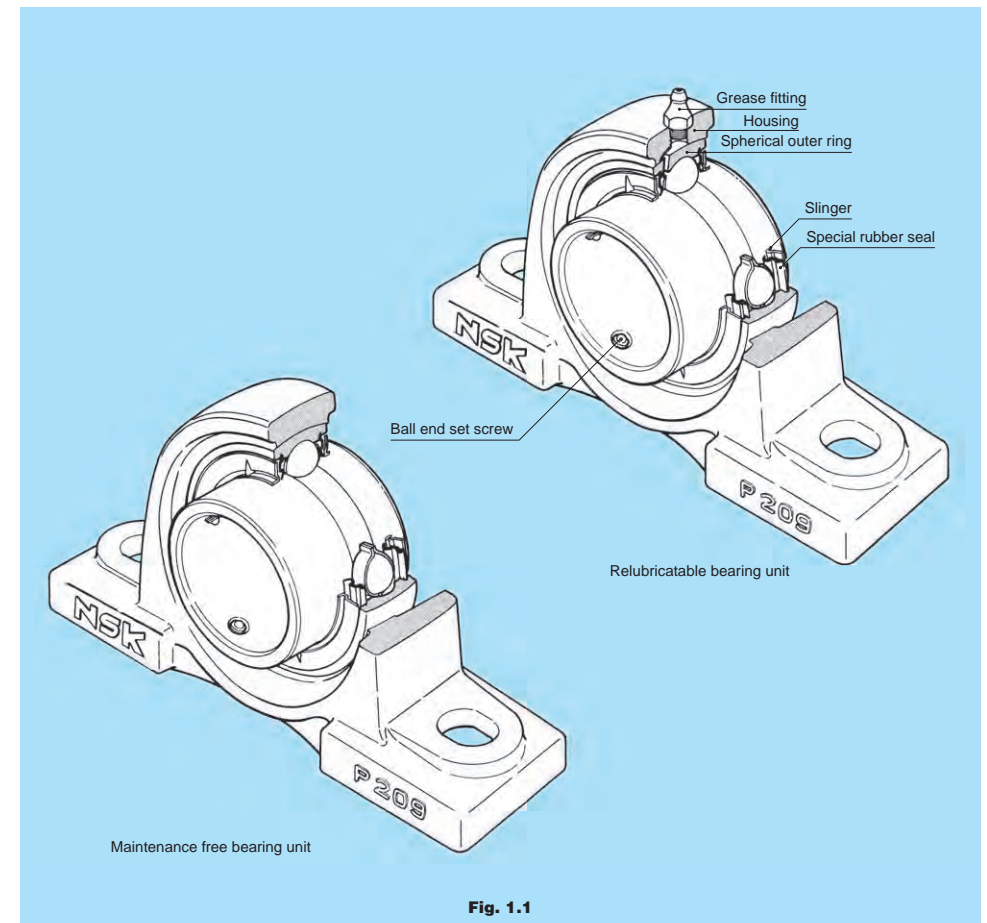

2. Design Features and Advantages

2.1 Maintenance free type

The **NSK** Maintenance free bearing unit contains a high-grade lithium-based grease, good for use over a long period, which is ideally suited to sealed-type bearings. Also provided is an excellent sealing device, which prevents any leakage of grease or penetration of dust and water from outside.

It is designed so that the rotation of the shaft causes the sealed-in grease to circulate through the inside space, effectively providing maximum lubrication. The lubrication effect is maintained over a long period with no need for replenishment of grease.

To summarize the advantages of the **NSK** maintenance free bearing unit:

- (1) As an adequate amount of good quality grease is sealed in at the time of manufacture, there is no need for replenishment. This means savings in terms of time and maintenance costs.
- (2) Since there is no need for any regreasing facilities, such as piping, a more compact design is possible.
- (3) The sealed-in design eliminates the possibility of grease leakage, which could lead to stained products.

2.2 Relubricatable type

The **NSK** relubricatable type bearing unit has an advantage over other similar units being so designed as to permit regreasing even in the case of misalignment of 2° to the right or left. The hole through which the grease fitting is mounted usually causes structural weakening of the housing.

However, as a result of extensive testing, in the **NSK** bearing unit the hole is positioned so as to minimize this adverse effect. In addition, the regreasing groove has been designed to minimize weakening of the housing.

While the **NSK** maintenance free type bearing unit is satisfactory for use under normal operating conditions in-doors, in the following circumstances it is necessary to use the relubricatable type bearing unit:

- (1) Cases where the temperature of the bearing rises above 100°C, 212°F:
* -Normal temperature of up to 130°C, 266°F heat-resistant bearing units.
- (2) Cases where there is excessive dust, but space does not permit using a bearing unit with a cover.
- (3) Cases where the bearing unit is constantly exposed to splashes of water or any other liquid, but space does not permit using a bearing unit with a cover.
- (4) Cases in which the humidity is very high, and the machine in which the bearing unit is used is run

only intermittently.

- (5) Cases involving a heavy load of which the C/P_r value is about 10 or below, and the speed is 10 min^{-1} or below, or the movement is oscillatory.
- (6) Cases where the number of revolutions is relatively high and the noise problem has to be considered; for example, when the bearing is used with the fan of an air conditioner.

2.3 Special sealing feature

2.3.1 Standard bearing units

The sealing device of the ball bearing for the **NSK** bearing unit is a combination of a heat-resistant and oil-proof synthetic rubber seal and a slinger of an exclusive design.

The seal, which is fixed in the outer ring, is steel-reinforced, and its lip, in contact with the inner ring, is designed to minimize frictional torque.

The slinger is fixed to the inner ring of the bearing with which it rotates. There is a small clearance between its periphery and the outer ring.

These two types of seals on both sides of the bearing prevent grease leakage, and foreign matter is prevented from entering the bearing from outside.

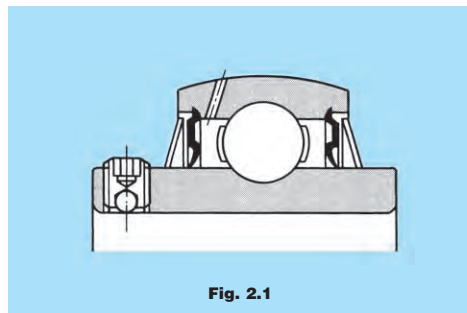

Fig. 2.1

2.3.2 Bearing units with covers

The **NSK** bearing unit with a cover consists of a standard bearing unit and an outside covering for extra protection against dust. Special consideration has been given to its design with respect to dust-proofing.

Sealing devices are provided in both the bearing and the housing, so that units of this type operate satisfactorily even in such adverse environments as flour mills, steel mills, foundries, galvanizing plants and chemical plants, where excessive dust is produced and/or liquids are used. They are also eminently suitable for outdoor environments where dust and rain are inevitable, and in heavy industrial machinery such as construction and transportation equipment.

The rubber seal of the cover contacts with the shaft by its two lips, as shown in Fig. 2.2 and 2.3. By filling the groove between the two lips with grease, an excellent sealing effect is obtained and, at the same time, the contacting portions of the lips are lubricated. Furthermore, the groove is so designed that when the shaft is inclined the rubber seal can move in the radial direction.

When bearing units are exposed to splashes of water rather than to dust, a drain hole (5 to 8 mm, 0.2 to 0.3 inches in diameter) is provided at the bottom of the cover, and grease should be applied to the side of the bearing itself instead of into the cover.

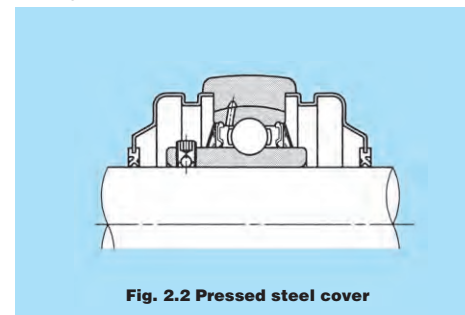

Fig. 2.2 Pressed steel cover

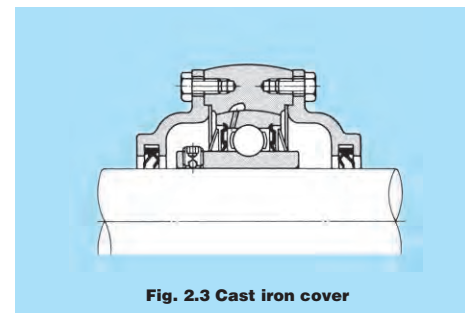

Fig. 2.3 Cast iron cover

2.4 Secure fitting

Fastening the bearing to the shaft is effected by tightening the ball-end set screw, situated on the inner ring. This is a unique feature which prevents loosening, even if the bearing is subjected to intense vibrations and shocks.

2.5 Self-aligning

With the **NSK** bearing unit, the outer surface of the ball bearing and the inner surface of the housing are spherical, thus this bearing unit has self-aligning characteristic. Any misalignment of axis that may arise from poor workmanship on the shaft or errors in fitting will be properly adjusted.

2.6 Higher rated load capacity

The bearing used in the unit is of the same internal construction as those in bearing series 62 and 63, and is capable of accommodating axial load as well as radial load, or composite load. The rated load capacity of this bearing is considerably higher than that of the corresponding self-aligning ball bearings used for standard plummer blocks.

2.7 Light weight yet strong housing

Housings for **NSK** bearing units come in various shapes. They consist of either high-grade cast iron, one-piece casting, or of precision finished pressed steel, the latter being lighter in weight. In either case, they are practically designed to combine lightness with maximum strength.

2.8 Easy mounting

The **NSK** bearing unit is an integrated unit consisting of a bearing and a housing.

As the bearing is prelubricated at manufacture with the correct amount of high-grade lithium base, it can be mounted on the shaft just as it is. It is sufficient to carry out a short test run after mounting.

2.9 Accurate fitting of the housing

In order to simplify the fitting of the pillow block and flange type bearing units, the housings are provided with a seat for a dowel pin, which may be utilized as needed.

2.10 Bearing replaceability

The bearing used in the **NSK** bearing unit is replaceable. In the event of bearing failure, a new bearing can be fitted to the existing housing.

3. Tolerance

The tolerances of the **NSK** bearing units are in accordance with the following JIS specifications:

3.1 Tolerances of ball bearings for the unit

The tolerances of ball bearings used in the unit are shown in the following tables, 3.1 to 3.4.

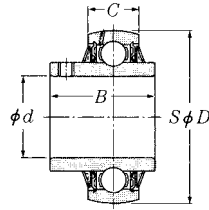

Set screw type

Table 3.1 (1) Cylindrical bore (UC, UCS, AS, ASS, UEL, UELS, AEL, AELS) Unit: $\mu\text{m}/0.0001$ inch

Nominal bore diameter d				Cylindrical bore						Radial runout K_{ra} (reference)
over		incl.		Bore diameter			Width			
mm	inch	mm	inch	Δ_{dmp} Deviations		V_{dp} Variations	Δ_{Bs}, Δ_{Cs} Deviations(reference)			
high	low	high	low	high	low	max.	high	low	max.	
10	0.3937	18	0.7087	+15	0	10	0	-120	15	
				+6	0	4	0	-47	6	
18	0.7087	31.75	1.2500	+18	0	12	0	-120	18	
				+7	0	5	0	-47	7	
31.75	1.2500	50.8	2.0000	+21	0	14	0	-120	20	
				+8	0	6	0	-47	8	
50.8	2.0000	80	3.1496	+24	0	16	0	-150	25	
				+9	0	6	0	-59	10	
80	3.1496	120	4.7244	+28	0	19	0	-200	30	
				+11	0	7	0	-79	12	
120	4.7244	180	7.0866	+33	0	22	0	-250	35	
				+13	0	9	0	-98	14	

Remarks Symbols

Δ_{dmp} : Mean bore diameter deviation V_{dp} : Bore diameter variation ΔB : Inner ring width deviation ΔC : Outer ring width deviation

Table 3.1 (2) Cylindrical bore (AR, JEL, JELS, REL) Unit: $\mu\text{m}/0.0001$ inch

Nominal bore diameter d				Cylindrical bore diameter		
over		incl.		Δ_{dmp} Deviations		V_{dp} Variations
mm	inch	mm	inch	high	low	max.
10	0.3937	18	0.7087	+13	0	6
				+5	0	2
18	0.7087	31.75	1.2500	+13	0	6
				+5	0	2
31.75	1.2500	50.8	2.0000	+13	0	6
				+5	0	2
50.8	2.0000	80	3.1496	+15	0	8
				+6	0	3

Table 3.1 (3) Cylindrical bore (CS) Unit: $\mu\text{m}/0.0001$ inch

Nominal bore diameter d				Cylindrical bore						Radial runout K_{ra} (reference)
over		incl.		Bore diameter			Width			
mm	inch	mm	inch	Δ_{dmp} Deviations		V_{dp} Variations	Δ_{Bs}, Δ_{Cs} Deviations(reference)			
high	low	high	low	high	low	max.	high	low	max.	
10	0.3937	18	0.7087	0	-8	10	0	-120	15	
				0	-3	4	0	-47	6	
18	0.7087	31.75	1.2500	0	-10	12	0	-120	18	
				0	-4	5	0	-47	7	
31.75	1.2500	50.8	2.0000	0	-12	14	0	-120	20	
				0	-5	6	0	-47	8	

Table 3.2 Tapered bore (UK, UKS) Unit: $\mu\text{m}/0.0001$ inch

Nominal bore diameter d				Δ_{dmp} Deviations		$\Delta_{dimp} - \Delta_{dmp}$		$V_{dp}^{(1)}$
over		incl.		high	low	max.	min.	max.
mm	inch	mm	inch	high	low	max.	min.	max.
18	0.7087	30	1.1811	+21	0	+21	0	13
				+8	0	+8	0	5
30	1.1811	50	1.9685	+25	0	+25	0	15
				+10	0	+10	0	6
50	1.9685	80	3.1496	+30	0	+30	0	19
				+12	0	+12	0	7
80	3.1496	120	4.7244	+35	0	+35	0	25
				+14	0	+14	0	10
120	4.7244	180	7.0866	+40	0	+40	0	31
				+16	0	+16	0	12

Note (1) To be applied for all radial flat surfaces of tapered hole.

Remarks 1. To be applied for tapered holes of 1/12.
2. Symbols of quantity or values

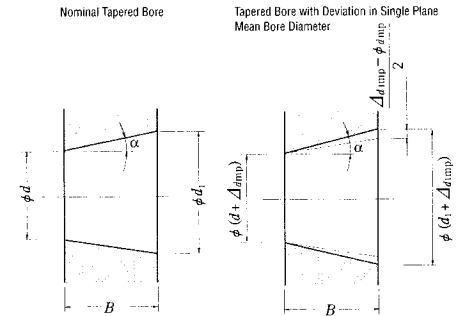

d : Nominal Bore Diameter

d_1 : Theoretical Diameter of Larger End of Tapered Bore

$$d_1 = d + 1/12 B$$

Δ_{dmp} : Single Plane Mean Bore Diameter Deviation in Theoretical Diameter of Smaller End of Bore

Δ_{dimp} : Single Plane Mean Bore Diameter Deviation in Theoretical Diameter of Larger End of Bore

V_{dp} : Bore diameter variation in a single radial plane

B : Nominal Inner Ring width

α : Half of Taper Angle of Tapered Bore

$$\begin{aligned} \alpha &= 2^\circ 23' 9.4'' \\ &= 2.38594^\circ \\ &= 0.041643 \text{ rad} \end{aligned}$$

Table 3.3 Outer ring

Unit: $\mu\text{m}/0.0001$ inch

Nominal outside diameter D				Mean outside diameter deviation Δ_{Dm}		Radial runout K_{ra} (reference)
over		incl.		high	low	max.
mm	inch	mm	inch			
18	0.7087	30	1.1811	0	-9	15
				0	-4	6
30	1.1811	50	1.9685	0	-11	20
				0	-4	8
50	1.9685	80	3.1496	0	-13	25
				0	-5	10
80	3.1496	120	4.7244	0	-15	35
				0	-6	14
120	4.7244	150	5.9055	0	-18	40
				0	-7	16
150	5.9055	180	7.0866	0	-25	45
				0	-10	18
180	7.0866	250	9.8425	0	-30	50
				0	-12	20
250	9.8425	315	12.4016	0	-35	60
				0	-14	24

Remarks The low deviation of outside diameter D_m does not apply within the distance of 1/4 the width of the outer ring from the side.

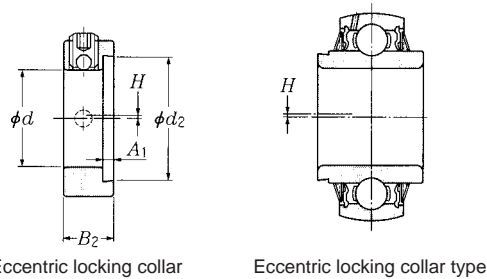

Table 3.4 Eccentric locking collar

Unit: mm/inch

Nominal bore diameter d				Bore diameter deviation Δ_{ds}		Small bore diameter of eccentric surface deviation Δ_{d2s}		Eccentricity deviation Δ_{Hs}		Collar width deviation Δ_{B2s}		Collar eccentric surface width deviation Δ_{A1s}	
over		incl.		high	low	high	low	high	low	high	low	high	low
mm	inch	mm	inch										
10	0.3937	36.512	1.4375	+0.250	+0.025	+0.3	0	+0.1	-0.1	+0.270	-0.270	0	-0.180
				+0.010	+0.001	+0.012	0	+0.004	-0.004	+0.011	-0.011	0	-0.007
36.512	1.4375	55.562	2.1875	+0.300	+0.025	+0.4	0	+0.1	-0.1	+0.330	-0.330	0	-0.180
				+0.012	+0.001	+0.016	0	+0.004	-0.004	+0.013	-0.013	0	-0.007
55.562	2.1875	61.912	2.4375	+0.300	+0.025	+0.4	0	+0.1	-0.1	+0.330	-0.330	0	-0.220
				+0.012	+0.001	+0.016	0	+0.004	-0.004	+0.013	-0.013	0	-0.009

3.2 Tolerances of housings

Table 3.5 Spherical bore diameter of housings

Unit: $\mu\text{m}/0.0001$ inch

Nominal spherical bore diameter D_a				D_a Deviations Δ_{Damp}					
over		incl.		Tolerance class H7		Tolerance class J7		Tolerance class K7	
mm	inch	mm	inch	high	low	high	low	high	low
30	1.1811	50	1.9685	+25	0	+14	-11	+7	-18
				+10	0	+6	-4	+3	-7
50	1.9685	80	3.1496	+30	0	+18	-12	+9	-21
				+12	0	+7	-5	+4	-8
80	3.1496	120	4.7244	+35	0	+22	-13	+10	-25
				+14	0	+9	-5	+4	-10
120	4.7244	180	7.0866	+40	0	+26	-14	+12	-28
				+16	0	+10	-6	+5	-11
180	7.0866	250	9.8425	+46	0	+30	-16	+13	-33
				+18	0	+12	-6	+5	-13
250	9.8425	315	12.4016	+52	0	+36	-16	+16	-36
				+20	0	+14	-6	+6	-14

Remarks 1. Symbols

Δ_{Damp} : Mean spherical bore diameter deviation

2. Dimensional tolerances for spherical bore diameter of housing are classified as H7 for clearance fit, and J7 for intermediate fit.

3. Spherical bore diameter of housings are finished by following tolerance classes such as 52mm or less : K7, over 52mm and 180mm or less : J7, and over 180mm : H7 respectively.

Table 3.6 Pillow block housings (P, PL, HP, UP)

Unit: mm/inch

Housing numbers						H Deviations Δ_{Hs}
P203	—	—	—	—	—	± 0.15 ± 0.006
P204	—	—	HP204	UP204	PL204	
P205	P305	PX05	HP205	UP205	PL205	
P206	P306	PX06	HP206	UP206	PL206	
P207	P307	PX07	HP207	UP207	PL207	
P208	P308	PX08	HP208	UP208	—	
P209	P309	PX09	HP209	UP209	PL209	
P210	P310	PX10	HP210	UP210	PL210	
P211	P311	PX11	—	—	—	
P212	P312	PX12	—	—	—	
P213	P313	PX13	—	—	—	± 0.2 ± 0.008
P214	P314	PX14	—	—	—	
P215	P315	PX15	—	—	—	
P216	P316	PX16	—	—	—	
P217	P317	PX17	—	—	—	
P218	P318	PX18	—	—	—	
—	P319	—	—	—	—	
—	P320	PX20	—	—	—	
—	P321	—	—	—	—	
—	P322	—	—	—	—	
—	P324	—	—	—	—	± 0.3 ± 0.012
—	P326	—	—	—	—	
—	P328	—	—	—	—	

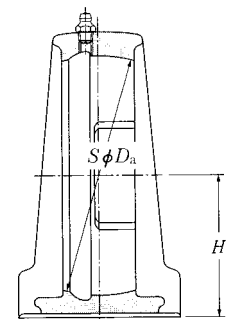

Remarks 1. H is height of the shaft center line.

2. This table can be applied for bearing units with dust covers.

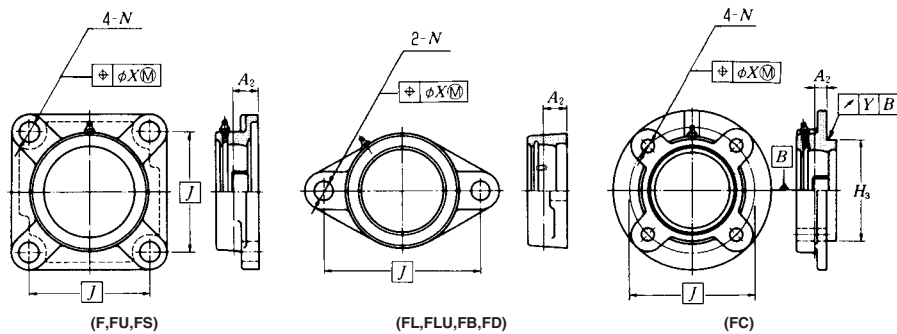

Table 3.7 (1) Flange unit housings (F, FU, FC, FS, FL, FLU, FB, FD)

Unit: mm/inch

Housing numbers		location tolerance of bolt hole X	A ₂ Deviations ΔA _{2s}	H ₃ Deviations ΔH _{3s}						Radial runout of spigot joint Y									
				FC2		FS3		FCX											
				high	low	high	low	high	low										
—	—	—	—	—	—	—	—	—	—	—									
F204	—	—	FC204	—	FL204	—	—	—	—	—									
F205	F305	FX05	FC205	FS305	FL205	FL305	FD205	0	-0.046	0	-0.046	0	-0.046	0	-0.046	0	-0.046	0	-0.046
F206	F306	FX06	FC206	FS306	FL206	FL306	FD206	0	-0.018	0	-0.018	0	-0.018	0	-0.018	0	-0.018	0	-0.018
F207	F307	FX07	FC207	FS307	FL207	FL307	FD207	0	0	0	0	0	0	0	0	0	0	0	0
F208	F308	FX08	FC208	FS308	FL208	FL308	—	0	-0.054	0	-0.054	0	-0.054	0	-0.054	0	-0.054	0	-0.054
F209	F309	FX09	FC209	FS309	FL209	FL309	—	0	-0.0021	0	-0.0021	0	-0.0021	0	-0.0021	0	-0.0021	0	-0.0021
F210	F310	FX10	FC210	FS310	FL210	FL310	—	0	0	0	0	0	0	0	0	0	0	0	0
F211	F311	FX11	FC211	FS311	FL211	FL311	—	0	-0.054	0	-0.054	0	-0.054	0	-0.054	0	-0.054	0	-0.054
F212	F312	FX12	FC212	FS312	FL212	FL312	—	0	-0.063	0	-0.063	0	-0.063	0	-0.063	0	-0.063	0	-0.063
F213	F313	FX13	FC213	FS313	FL213	FL313	—	0	-0.0025	0	-0.0025	0	-0.0025	0	-0.0025	0	-0.0025	0	-0.0025
F214	F314	FX14	FC214	FS314	FL214	FL314	—	0	-0.063	0	-0.063	0	-0.063	0	-0.063	0	-0.063	0	-0.063
F215	F315	FX15	FC215	FS315	FL215	FL315	—	0	-0.0025	0	-0.0025	0	-0.0025	0	-0.0025	0	-0.0025	0	-0.0025
F216	F316	FX16	FC216	FS316	FL216	FL316	—	0	0	0	0	0	0	0	0	0	0	0	0
F217	F317	FX17	FC217	FS317	FL217	FL317	—	0	-0.072	0	-0.072	0	-0.072	0	-0.072	0	-0.072	0	-0.072
F218	F318	FX18	FC218	FS318	FL218	FL318	—	0	-0.0028	0	-0.0028	0	-0.0028	0	-0.0028	0	-0.0028	0	-0.0028
—	F319	—	—	FS319	—	FL319	—	0	0	0	0	0	0	0	0	0	0	0	0
—	F320	FX20	—	FS320	—	FL320	—	—	—	—	—	—	—	—	—	—	—	—	—
—	F321	—	—	FS321	—	FL321	—	0	-0.081	0	-0.081	0	-0.081	0	-0.081	0	-0.081	0	-0.081
—	F322	—	—	FS322	—	FL322	—	0	-0.0032	0	-0.0032	0	-0.0032	0	-0.0032	0	-0.0032	0	-0.0032
—	F324	—	—	FS324	—	FL324	—	—	—	—	—	—	—	—	—	—	—	—	—
—	F326	—	—	FS326	—	FL326	—	0	-0.089	0	-0.089	0	-0.089	0	-0.089	0	-0.089	0	-0.089
—	F328	—	—	FS328	—	FL328	—	0	-0.0035	0	-0.0035	0	-0.0035	0	-0.0035	0	-0.0035	0	-0.0035

- Remarks**
1. J is the bolt hole's center line dimension, and P.C.D. A₂ is distance between the center line of spherical bore diameter of the housing and mounting surfaces, and H₃ is outside diameter of the spigot joint.
 2. Radial runout of spigot joint is applied for flange units with spigot joints.
 3. For FU2 and FLU2 types, tolerances for F2 shall be applied.
 4. For FCX and FLX types, tolerances for FX shall be applied.
 5. This table can be applied for bearing units with dust covers.

Table 3.7 (2) Flange unit housings (diameter of bolt hole)

Housing type	Nominal bore diameter N				N Deviations ΔN _s	
	over		incl.		mm	inch
	mm	inch	mm	inch		
F, FU, FC, FS FA, FH, FLU	—	—	30	1.1811	±0.2	±0.008
	30	1.1811	41	1.6142	±0.3	±0.012

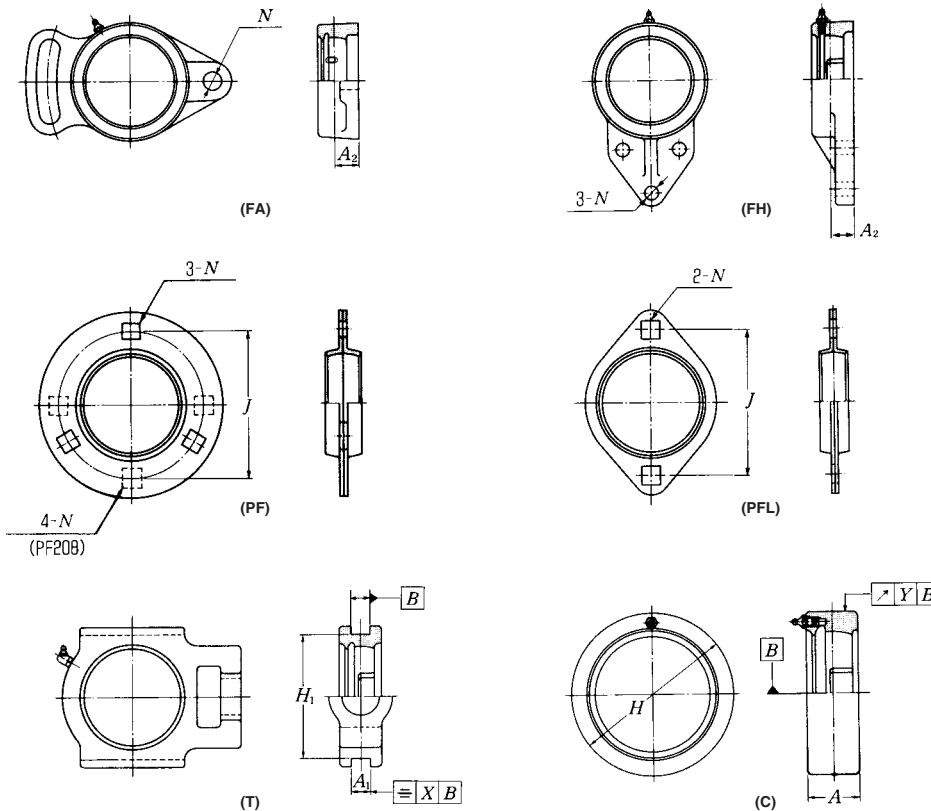

Table 3.8 Flange unit housings (FH, FA, PF, PFL)

Unit: mm/inch

Housing numbers	A ₂ Deviations ΔA _{2s}	Housing numbers	J Deviations ΔJ _s	N Deviations ΔN _s
—	±0.5 ±0.020	PF203	±0.4 ±0.016	±0.25 ±0.010
FH, FA204		PF204		
FH, FA205		PF205		
FH, FA206		PF206		
FH, FA207		PF207		
FH, FA208		PF208		
FH, FA209		PFL203		
FH, FA210	PFL204			
		PFL205		
		PFL206		
FA211	±0.8 ±0.032	PFL207		

- Remarks**
1. A₂ is distance between the center line of spherical bore diameter of housings.
 2. J is the bolt hole's center line dimension.

Table 3.9 Take-up unit housings (T) Unit: mm/inch

Housing numbers	A ₁ Deviations ΔA _{1s}	H ₁ Deviations ΔH _{1s}		Parallelism of guide X
		high	low	
		T204 — —		
T205 T305 TX05				
T206 T306 TX06	+0.2	0	-0.5	0.5
T207 T307 TX07	0	0	-0.020	0.020
T208 T308 TX08	+0.008			
T209 T309 TX09	0			
T210 T310 TX10				
T211 T311 TX11				
T212 T312 TX12				
T213 T313 TX13				
T214 T314 TX14				0.6
T215 T315 TX15				0.024
T216 T316 TX16				
T217 T317 TX17	+0.3	0	-0.8	
— T318 —	0	0	-0.032	
— T319 —	+0.012			
— T320 —	0			0.7
— T321 —				0.028
— T322 —				
— T324 —				
— T326 —				0.8
— T328 —				0.032

Remarks 1. A₁ is the width of guide rail grooves.
 2. H₁ is the maximum span of guide rail grooves.
 3. This table can be applied for bearing units with dust covers.

Table 3.10 Cartridge unit housings (C) Unit: mm/inch

Housing numbers	H Deviations ΔH _s						Radial runout of outside surface Y	A Deviations ΔA _s
	C2 Series		C3 Series		CX Series			
	high	low	high	low	high	low		
C204 — —	0	-0.030	—	—	—	—		
C205 C305 CX05	0	-0.0012						
C206 C306 CX06			0	-0.035	0	-0.035	0.2	
C207 C307 CX07			0	-0.0014	0	-0.0014	±0.008	
C208 C308 CX08	0	-0.035						
C209 C309 CX09	0	-0.0014						
C210 C310 CX10					0	-0.040		
C211 C311 CX11			0	-0.040	0	-0.0016		
C212 C312 CX12	0	-0.040		-0.0016				
C213 C313 —								
— C314 —							0.3	
— C315 —							0.012	
— C316 —								
— C317 —			0	-0.046				
— C318 —			0	-0.0018				
— C319 —					—	—		
— C320 —	—	—						
— C321 —			0	-0.052				
— C322 —			0	-0.0020				
— C324 —							0.4	
— C326 —			0	-0.057			0.016	
— C328 —			0	-0.0022				

Remarks 1. H is the outside diameter of cartridge housings.
 2. A is width of cartridge housings.

4. Basic Load Rating and Life

4.1 Bearing life

Even in bearings operating under normal conditions, the surfaces of the raceway and rolling elements are constantly being subjected to repeated compressive stresses which cause flaking of these surfaces to occur. This flaking is due to material fatigue and will eventually cause the bearings to fail. The effective life of a bearing is usually defined in terms of the total number of revolutions a bearing can undergo before flaking of either the raceway surface or the rolling element surfaces occurs.

Other causes of bearing failure are often attributed to problems such as seizing, abrasions, cracking, chipping, gnawing, rust, etc. However, these so called "causes" of bearing failure are usually themselves caused by improper installation, insufficient or improper lubrication, faulty sealing or inaccurate bearing selection. Since the above mentioned "cause" of bearing failure can be avoided by taking the proper precautions, and are not simply caused by material fatigue, they are considered separately from the flaking aspect.

4.2 Basic rated life and basic dynamic load rating

A group of seemingly identical bearings when subjected to identical load and operating conditions will exhibit a wide diversity in their durability.

This "life" disparity can be accounted for by the difference in the fatigue of the bearing material itself. This disparity is considered statistically when calculating bearing life, and the basic rated life is defined as follows.

The basic rated life is based on a 90% statistical model which is expressed as the total number of revolutions 90% of the bearings, in an identical group of bearings subjected to identical operating conditions, will attain or surpass before flaking due to material fatigue occurs. For bearings operating at fixed constant speeds, the basic rated life (90% reliability) is expressed in the total number of hours of operation.

The basic dynamic load rating is an expression of the load capacity of a bearing based on a constant load which the bearing can sustain for one million revolutions (the basic life rating). For radial bearings this rating applies to pure radial loads, and for thrust bearings it refers to pure axial loads. The basic dynamic load ratings given in the bearing tables of this catalog are for bearings constructed of standard bearing materials, using standard manufacturing techniques. Please consult **NSK** for basic load ratings of bearings constructed of special materials or using special

manufacturing techniques.

The relationship between the basic rated life, the basic dynamic load rating and the bearing load is given in formula (4.1).

$$L_{10} = \left(\frac{C_r}{P_r} \right)^3 \dots \dots \dots (4.1)$$

where,

- L₁₀: Basic rated life 10⁶ revolutions
- C_r: Basic dynamic rated load, N, lbf
- P_r: Equivalent dynamic load, N, lbf

The basic rated life can also be expressed in terms of hours of operation (revolution), and is calculated as shown in formula (4.2).

$$L_{10h} = 500f_n^3 \dots \dots \dots (4.2)$$

$$f_n = f_n \frac{C_r}{P_r} \dots \dots \dots (4.3)$$

$$f_n = \left(\frac{33.3}{n} \right)^{1/3} \dots \dots \dots (4.4)$$

where,

- L_{10h}: Basic rated life, h
- f_n: Life factor
- f_n: Speed factor
- n: Rotational speed, min⁻¹

Formula (4.2) can also be expressed as shown in formula (4.5).

$$L_{10h} = \frac{10^6}{60n} \left(\frac{C_r}{P_r} \right)^3 \dots \dots \dots (4.5)$$

The relation between rotational speed n and speed factor f_n as well as the relation between the basic rated life L_{10h} and the life factor f_n is shown in Fig. 4.1.

When several bearings are incorporated in machines or equipment as complete units, all the bearings in the unit are considered as a whole when computing bearing life (see formula 4.6). The total bearing life of the unit is a life rating based on the viable lifetime of the unit before even one of the bearings fails due to rolling contact fatigue.

$$L = \frac{1}{\left(\frac{1}{L_1^{1.1}} + \frac{1}{L_2^{1.1}} + \dots + \frac{1}{L_n^{1.1}}\right)^{1/1.1}} \dots\dots(4.6)$$

where,
L : Total life of the whole bearing assembly, h
*L*₁, *L*₂, ... *L*_{*n*}: Rated life of bearings 1, 2, ... *n*, h

In the case where load and the number of revolutions change at regulated intervals, after finding the rated life *L*₁, *L*₂, ... *L*_{*n*} under conditions of *n*₁, *P*₁; *n*₂, *P*₂; ... *n*_{*n*}, *P*_{*n*}: the built-in life *L*_{*m*} can be given by the formula (4.7).

$$L_1 = \frac{10^6}{60n_1} \left(\frac{C_r}{P_1}\right)^3$$

$$L_2 = \frac{10^6}{60n_2} \left(\frac{C_r}{P_2}\right)^3$$

$$\vdots$$

$$L_n = \frac{10^6}{60n_n} \left(\frac{C_r}{P_n}\right)^3$$

$$L_m = \left(\frac{\phi_1}{L_1} + \frac{\phi_2}{L_2} + \dots + \frac{\phi_n}{L_n}\right)^{-1} \dots\dots\dots(4.7)$$

where,
*L*₁, *L*₂, ... *L*_{*n*}: Rated life under condition 1, 2, ... *n*, h
*n*₁, *n*₂, ... *n*_{*n*}: Number of revolutions under condition 1, 2, ... *n*, min⁻¹
*P*₁, *P*₂, ... *P*_{*n*}: Equivalent load under condition 1, 2, ... *n*, N, lbf
 $\phi_1, \phi_2, \dots, \phi_n$: Ratio of condition 1, 2, ... *n* accounting for the total operating time
*L*_{*m*}: Built-in life, h

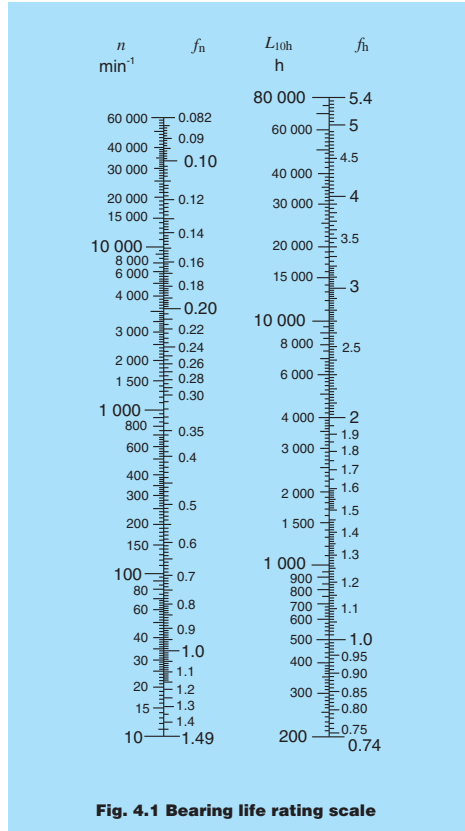

Fig. 4.1 Bearing life rating scale

Table 4.1 Rating life for applications

Service classification	Machine application	Life time <i>L_m</i>
Machines used occasionally	Door mechanisms, Garage shutter	500
Equipment for short period or intermittent service-interruption permissible	Household appliances, Electric hand tools, Agricultural machines, Lifting tackles in shops	4 000 to 8 000
Intermittent service machines-high reliability	Power-Station auxiliary equipment, Elevators, Conveyors, Deck cranes	8 000 to 14 000
Machines used for 8 hours a day, but not always in full operation	Ore wagon axles, important gear units	14 000 to 20 000
Machines fully used for 8 hours	Blowers, General machinery in shops, Continuous operation cranes	20 000 to 30 000
Machines continuously used for 24 hours a day	Compressors, Pumps	50 000 to 60 000
Machines continuously used for 24 hours a day with maximum reliability	Power-station equipment, Water-supply equipment for urban areas, Mine ventilators	100 000 to 200 000

4.3 Basic static load rating

When stationary rolling bearings are subjected to static loads, they suffer from partial permanent deformation of the contact surfaces at the contact point between the rolling elements and the raceway. The amount of deformity increases as the load increases, and if this increase in load exceeds certain limits, the subsequent smooth operation of the bearing is impaired.

It has been found through experience that a permanent deformity of 0.0001 times the diameter of the rolling element, occurring at the most heavily stressed contact point between the raceway and the rolling elements, can be tolerated without any impairment in running efficiency.

The basic rated static load refers to a fixed static load limit at which a specified amount of permanent deformation occurs. It applies to pure radial loads for radial bearings. The maximum applied load values for contact stress occurring at the rolling element and raceway contact points are given below.

For ball bearings (for bearing unit): 4 200 MP.

4.4 Allowable static equivalent load

Generally the static equivalent load which can be permitted is limited by the basic static rated load as stated in Section 4.3. However, depending on requirements regarding friction and smooth operation, these limits may be greater or lesser than the basic static rated load.

In the following formula (4.8) and Table 4.2 the safety factor *S*₀ can be determined considering the maximum static equivalent load.

$$S_0 = \frac{C_0}{P_{0 \max}} \dots\dots\dots(4.8)$$

where,

*S*₀: Safety factor

*C*₀: Basic static rated load, N, lbf

*P*_{0 max}: Maximum static equivalent load, N, lbf

Table 4.2 Minimum safety factor values *S*₀

Operating conditions	Ball bearings
High rotational accuracy demand	2
Normal rotating accuracy demand (Universal application)	1
Slight rotational accuracy deterioration permitted (Low speed, heavy loading, etc.)	0.5

Remarks When vibration and/or shock loads are present, a load factor based on the shock load needs to be included in the *P*_{0 max} value.

5. Bearing Internal Clearance

5.1 Bearing internal clearance

Bearing internal clearance (initial clearance) is the amount of internal clearance a bearing has before being installed on a shaft or in a housing.

As shown in Fig. 5.1, when either the inner ring or the outer ring is fixed and the other ring is free to move, displacement can take place in either an axial or radial direction. This amount of displacement (radially or axially) is termed the internal clearance and, depending on the direction, is called the radial internal clearance or the axial internal clearance.

When the internal clearance of a bearing is measured, a slight measurement load is applied to the raceway so the internal clearance may be measured accurately. However, at this time, a slight amount of elastic deformation of the bearing occurs under the measurement load, and the clearance measurement value (measured clearance) is slightly larger than the true clearance. This discrepancy between the true bearing clearance and the increased amount due to the elastic deformation must be compensated for. These compensation values are given in Table 5.1.

The internal clearance values for each bearing class are shown in Tables 5.3.

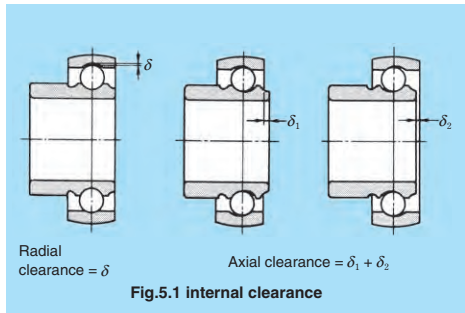

Table 5.1 Adjustment of radial internal clearance based on measured load Unit: μm

Nominal Bore Diameter <i>d</i> (mm)	Measuring Load (N)	Radial Clearance Increase					
		C2	CN	C3	C4	C5	
over 10	incl. 18	24.5	3 to 4	4	4	4	4
18	50	49	4 to 5	5	6	6	6
50	200	147	6 to 8	8	9	9	9

5.2 Internal clearance selection

The internal clearance of a bearing under operating conditions (effective clearance) is usually smaller than the same bearing's initial clearance before being installed and operated. This is due to several factors including bearing fit, the difference in temperature between the inner and outer rings, etc. As a bearing's operating clearance has an effect on bearing life, heat generation, vibration, noise, etc.; care must be taken in selecting the most suitable operating clearance.

Effective internal clearance:

The internal clearance differential between the initial clearance and the operating (effective) clearance (the amount of clearance reduction caused by interference fits, or clearance variation due to the temperature difference between the inner and outer rings) can be calculated by the following formula:

$$\delta_{\text{eff}} = \delta_o - (\delta_i + \delta_t) \quad (5.1)$$

where,

δ_{eff} : Effective internal clearance, mm

δ_o : Bearing internal clearance, mm

δ_i : Reduced amount of clearance due to interference, mm

δ_t : Reduced amount of clearance due to temperature differential of inner and outer rings, mm

Reduced clearance due to interference:

When bearings are installed with interference fits on shafts and in housings, the inner ring will expand and the outer ring will contract; thus reducing the bearings' internal clearance. The amount of expansion or contraction varies depending on the shape of the bearing, the shape of the shaft or housing, dimensions of the respective parts, and the type of materials used. The differential can range from approximately 70% to 90% of the effective interference.

$$\delta_i = (0.70 \text{ to } 0.90) \cdot \Delta d_{\text{eff}} \quad (5.2)$$

where,

δ_i : Reduced amount of clearance due to interference, mm

Δd_{eff} : Effective interference, mm

Reduced internal clearance due to inner/outer ring temperature difference:

During operation, normally the outer ring will be from 5° to 10°C cooler than the inner ring or rotating parts. However, if the cooling effect of the housing is large,

the shaft is connected to a heat source, or a heated substance is conducted through the hollow shaft; the temperature difference between the two rings can be ever greater. The amount of internal clearance is thus further reduced by the differential expansion of the two rings.

$$\delta_t = \alpha \cdot \Delta T \cdot D_o \quad (5.3)$$

where,

δ_t : Amount of reduced clearance due to heat differential, mm

α : Bearing steel linear expansion coefficient $12.5 \times 10^{-6}/^\circ\text{C}$

ΔT : Inner/outer ring temperature differential, °C

D_o : Outer ring raceway diameter, mm

Outer ring raceway diameter, D_o , values can be approximated by using formula 5.4.

For ball bearings,

$$D_o = 0.20(d + 4.0D) \quad (5.4)$$

where,

d : Bearing bore diameter, mm

D : Bearing outside diameter, mm

5.3 Bearing internal clearance selection standards

Theoretically, in regard to bearing life, the optimum operating internal clearance for any bearing would be a slight negative clearance after the bearing had reached normal operating temperature.

Unfortunately, under actual operating conditions, maintaining such optimum tolerances is often difficult at best. Due to various fluctuating operating conditions this slight minus clearance can quickly become a large minus, greatly lowering the life of the bearing and causing excessive heat to be generated. Therefore, an initial internal clearance which will result in a slightly greater than negative internal operating clearance should be selected.

Under normal operating conditions (e.g. normal load, fit, speed, temperature, etc.), a standard internal clearance will give a very satisfactory operating clearance.

Table 5.2 lists non-standard clearance recommendations for various applications and operating conditions.

Table 5.2 Examples of applications where bearing clearances other than normal clearance are used

Operating conditions	Applications	Selected clearance
Shaft is heated and housing is cooled.	Conveyor of casting machine	C5
Shaft or inner ring is heated.	Annealing pit, Drying pit, Curing pit	C4
Allows for shaft deflection and fitting errors.	Disc harrows	C4
	Combines	C3
Tight-fitted for both inner and outer rings.	Large blowers	C3
To reduce noise and vibration when rotating.	Multi-wing fan of air conditioners	C2

Table 5.3(1) Cylindrical bore bearings

Unit: $\mu\text{m}/0.0001 \text{ inch}$

Nominal bore diameter d				Radial internal clearance															
				C2		CN		C3		C4									
over	incl.			min.	max.	min.	max.	min.	max.	min.	max.								
mm	inch	mm	inch																
10	0.3937	18	0.7087	0	0	9	4	3	1	18	7	11	4	25	10	18	7	33	13
18	0.7087	24	0.9449	0	0	10	4	5	2	20	8	13	5	28	11	20	8	36	14
24	0.9449	30	1.1811	1	0	11	4	5	2	20	8	13	5	28	11	23	9	41	16
30	1.1811	40	1.5748	1	0	11	4	6	2	20	8	15	6	33	13	28	11	46	18
40	1.5748	50	1.9685	1	0	11	4	6	2	23	9	18	7	36	14	30	12	51	20
50	1.9685	65	2.5591	1	0	15	6	8	3	28	11	23	9	43	17	38	15	61	24
65	2.5591	80	3.1496	1	0	15	6	10	4	30	12	25	10	51	20	46	18	71	28
80	3.1496	100	3.9370	1	0	18	7	12	5	36	14	30	12	58	23	53	21	84	33
100	3.9370	120	4.7244	2	1	20	8	15	6	41	16	36	14	66	26	61	24	97	38
120	4.7244	140	5.5118	2	1	23	9	18	7	48	19	41	16	81	32	71	28	114	45

Remarks Heat-resistant bearings with suffix HT2 have C4 clearances.

Table 5.3(2) Tapered bore bearings

Unit: $\mu\text{m}/0.0001 \text{ inch}$

Nominal bore diameter d				Radial internal clearance															
				C2		CN		C3		C4									
over	incl.			min.	max.	min.	max.	min.	max.	min.	max.								
mm	inch	mm	inch																
24	0.9449	30	1.1811	5	2	20	8	13	5	28	11	23	9	41	16	30	12	53	21
30	1.1811	40	1.5748	6	2	20	8	15	6	33	13	28	11	46	18	40	16	64	25
40	1.5748	50	1.9685	6	2	23	9	18	7	36	14	30	12	51	20	45	18	73	29
50	1.9685	65	2.5591	8	3	28	11	23	9	43	17	38	15	61	24	55	22	90	35
65	2.5591	80	3.1496	10	4	30	12	25	10	51	20	46	18	71	28	65	26	105	41
80	3.1496	100	3.9370	12	5	36	14	30	12	58	23	53	21	84	33	75	30	120	47
100	3.9370	120	4.7244	15	6	41	16	36	14	66	26	61	24	97	38	90	35	140	55
120	4.7244	140	5.5118	18	7	48	19	41	16	81	32	71	28	114	45	105	41	160	63

6. Lubrication

As bearings in **NSK** bearing units have sufficient high-grade grease sealed in at the time of manufacture, there is no need for replenishment while in use. The amount of grease necessary for lubrication is, in general, very small. With the **NSK** bearing units, the amount of grease occupies about a half to a third of the space inside the bearing.

6.1 Maximum permissible speed of rotation

The maximum speed possible while ensuring the safety and long life of ball bearings used in the unit is limited by their size, the circumferential speed at the point where the seal comes into contact, and the load acting on them.

To indicate the maximum speed permissible, it is customary to use the value of dn or $d_m n$ (d is the bore of the bearing; d_m is the diameter of the pitch circle= $(D + O.D.) / 2$; n is the number of revolutions).

Problem connected with the lubrication of bearings are the generation of heat and seizures occurring at the sliding parts inside the bearing, in particular at the points where the ball is in contact with the retainer, inner and outer rings. The contact pressure at the points where friction occurs on the retainer is only

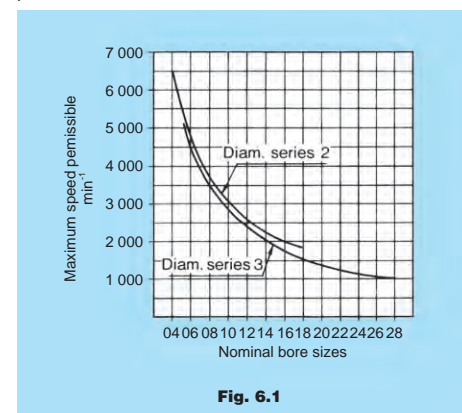

Fig. 6.1

slightly affected by the load acting on the bearing; the amount of heat generated there is approximately in proportion to the sliding velocity. Therefore, this sliding velocity serves as a yardstick to measure the limit of the rotating speed of the bearing. In the case of a bearing unit, however, there is another large factor that has to be taken into account—the circumferential speed at the part where the seal is in contact.

The graph in Fig.6.1 indicates the maximum speed of rotation permissible, taking into account the aforementioned factors.

There are two common methods of locking the bearing unit onto the shaft—the set screw system and the eccentric collar system. However, in both of these systems high-speed operation will cause deformation of the inner ring, which may result in vibration of the bearing. For high-speed operation, therefore, it is recommended that an interference fit or a clearance fit with a near-zero clearance be used.

For standard bearing units with the contact type seal, the maximum speed permissible is $120\,000/d$. Where a higher speed is required, bearing units with the non-contact type seal, are advised. Please contact **NSK** regarding the use of the latter type. Additionally, it is necessary that the surface on which the housing is mounted be finished to as high a degree of accuracy as possible. A regularity of within $\pm 0.05\text{mm}$, $\pm 0.002\text{inch}$ is required.

6.2 Replenishment of grease

6.2.1 Sealed-in grease

With **NSK** bearing units, no relubrication is the general rule. The standard self-lubricating type of bearing units contain high-grade lithium-based grease which, being suitable for long-term use, is ideal for sealed-type bearings. Relubrication, therefore, is unnecessary under most operating conditions.

At high temperatures, or where there is exposure to: water or excessive dust, the highest quality grease is essential. Therefore, **NSK** uses its own specially selected brands which are shown in Table 6.1. It is necessary to use the same brand when replenishing grease.

Table 6.1 Brands of grease used in NSK bearing units

Bearing units	Grease			Symbols	Operating temperature range °C, °F
	Name of grease	Thickening agent	Base oil		
Standard	Alvania grease S3	Li soap	Mineral oil	D1	-10°to +100°C, (+14°to +212°F).
Heat-resistant	SH44MT	Li soap	Silicone oil	HT2D1	Nomal temp.to + 130°C(266°F).
Cold-resistant	SH33L	Li soap	Silicone oil	CT1D1	-60°C(-76°F)to nomal temp.

6.2.2 Mixing of different kinds of grease

Whether or not different kinds of grease may be mixed usually depends on their thickeners. The commonly used criteria are shown in Table 6.2. Properties which are most susceptible to influences from mixing are viscosity, dropping point and penetration. Water and heat resisting properties as well as mechanical stability are also lowered. Therefore, when mixing in a grease which is different to that which is already in use, it is essential that the thickener (soap base) and the base oil be of the same group.

When relubricating NSK bearing units, it is advisable to use the brands of grease shown in Table 6.1

Table 6.2 Mixing properties of grease

Soap base	Ca	Na	Al	Ba	Li
Ca	○	△	△	×	△
Na	△	○	△	×	×
Al	△	△	○	×	×
Ba	×	×	×	○	×
Li	△	×	×	×	○

○ Mixing will not produce any appreciable change of properties.
 △ Mixing may produce considerable variations of properties.
 × Mixing will cause a drastic change of properties.

Table 6.3 Standard relubrication frequencies

Type of unit	Symbol	dn Value	Environmental conditions	Operating temp. °C, °F	Relubrication frequency	
					Hours	Period
Standard	D1	40 000 and below	Ordinary	-10 to +80, +14 to +176	1 500 to 3 000	6 to 12 mo.
Standard	D1	70 000 and below	Ordinary	-10 to +80, +14 to +176	1 000 to 2 000	3 to 6 mo.
Standard	D1	70 000 and below	Ordinary	+80 to +100, +176 to +212	500 to 700	1 mo.
Heat-resistant	HT2D1	70 000 and below	Ordinary	+100 to +130, +212 to +266	300 to 700	1 mo.
Cold-resistant	CT1D1	70 000 and below	Ordinary	-60 to +80, -76 to +176	1 000 to 2 000	3 to 6 mo.
Standard	D1	70 000 and below	Very dusty	-10 to +100, +14 to +212	100 to 500	1 wk. to 1 mo.
Standard	D1	70 000 and below	Exposed to water splashes	-10 to +100, +14 to +212	30 to 100	1 day to 1 wk.

6.2.3 Relubrication frequency

Relubrication frequency varies with the kind and quality of grease used as well as the operating conditions. Therefore, it is difficult to establish a general rule, but under ordinary operating conditions, it is desirable that grease be replenished before one third (1/3) of its calculated life elapses. It is necessary, however, to take into consideration such factors as hardening of grease in the oil hole, making replenishment impossible; deterioration of grease while operation of the machine is suspended, and so forth.

In Table 6.3 below are shown standard relubrication frequencies. Irrespective of the calculated life of the grease, this list takes into consideration such factors as the rotational speed of the bearings, operating temperatures and environmental conditions, with a view to safety.

6.2.4 Re-greasing

The performance of a bearing is greatly influenced by the quantity of grease. In order to avoid over-filling, it is advisable to replenish the grease while the machine is in operation.

Continue to insert grease until a little oozes out from between the outer ring raceway and the periphery of the slinger, for optimum performance.

6.3 Grease fitting

NSK bearing units are, as a general rule, provided with a grease fitting, as shown in Table 6.4, and a grease gun is used for regreasing. However, button-head and pin types may also be furnished on demand.

Grease fitting dimensions and the designation of applicable bearing units are given in Table 6.5.

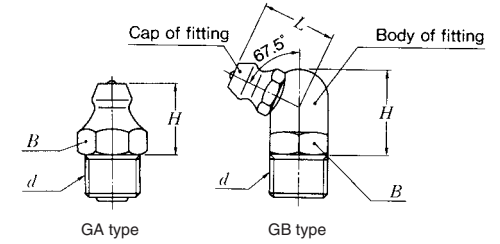

Table 6.4 Grease fitting types available for bearing units.

Types of housing	Standard grease fitting types
Pillow type	GA type
Flange type	GA type
Take-up type	GB type
Hanger type	GA type
Cartridge type	GA type

Table 6.5 Grease fitting dimensions and designations of applicable bearing units

GA type (Vertical type)

Designation	d	H		B	
		mm	inch	mm	inch
GA- $\frac{1}{4}$ -28 UNF	$\frac{1}{4}$ -28 UNF	8.5	0.335	7	0.276
GA-PF $\frac{1}{8}$	G $\frac{1}{8}$	12	0.472	10	0.394
GA-PF $\frac{1}{4}$	G $\frac{1}{4}$	14	0.551	14	0.551

GB type (67.5°)









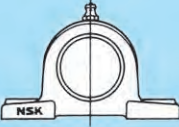
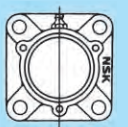
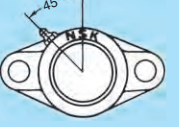
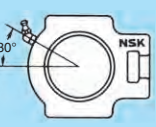
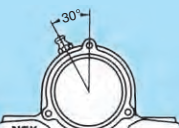

Designation	d	H		L		B	
		mm	inch	mm	inch	mm	inch
GB- $\frac{1}{4}$ -28 UNF	$\frac{1}{4}$ -28 UNF	10.5	0.413	9.3	0.366	8	0.315
GB-PF $\frac{1}{8}$	G $\frac{1}{8}$	14.2	0.559	13.5	0.531	10	0.394
GB-PF $\frac{1}{4}$	G $\frac{1}{4}$	15	0.591	13.5	0.531	14	0.551

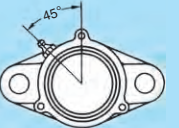
Nominal screw size d	Series 2	Series X	Series 3
$\frac{1}{4}$ -28 UNF	203 - 209	X05 - X08	305 - 309
G $\frac{1}{8}$	210 - 215	X09 - X14	310 - 315
G $\frac{1}{4}$	216 - 218	X15 - X20	316 - 328

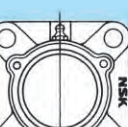
Remarks Screw size for the cartridge type is $\frac{1}{4}$ -28 UNF.
 That for C310D1 to C328D1 is G $\frac{1}{8}$ (PF $\frac{1}{8}$).

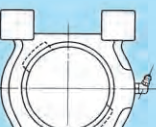
6.4 standard location of the grease fitting

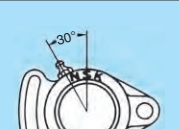
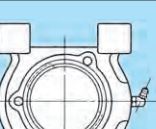
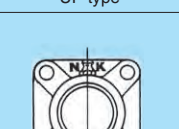
Standard location of grease fitting on the housing for the relubricatable bearing units of each type is illustrated below.

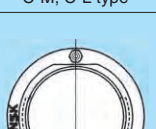
			
P, PL, Z-P, type	C-F type	FL, FLU, Z-FL type	T, Z-T type
			
C-P type	F, FU, Z-F (#204, #205)	C-FL type	C-T type
			
HP type	C-FS type	FH type	M, L, Z-M, Z-L type
			
UP type	FC, Z-FC type	FA type	C-M, C-L type
			
Except (#204, #205) F, FU, Z-F type	C-FC type	HB type	C type

7. Recommended Torques for Tightening Set Screws

Table 7.1 Recommended torques for tightening set screws

A) Metric series, applied to metric bore size.

Designation of the bearings of applicable units			Designation of set screws	Tightening torques N·m(max.)
UC201 to UC205	—	—	M 5×0.8 × 7	3.9
UC206	—	UC305 to UC306	M 6×0.75 × 8	4.9
UC207	UCX05	—	M 6×0.75 × 8	5.8
UC208 to UC210	—	—	M 8×1 ×10	7.8
UC211	UCX06 to UCX08	UC307	M 8×1 ×10	9.8
UC212	UCX09	—	M10×1.25 ×12	16.6
UC213 to UC215	—	UC308 to UC309	M10×1.25 ×12	19.6
UC216	UCX10	—	M10×1.25 ×12	22.5
—	UCX11 to UCX12	—	M10×1.25 ×12	24.5
UC217 to UC218	UCX13 to UCX15	UC310 to UC314	M12×1.5 ×13	29.4
—	UCX16 to UCX17	—	M12×1.5 ×13	34.3
—	UCX18	UC315 to UC316	M14×1.5 ×15	34.3
—	UCX20	UC317 to UC319	M16×1.5 ×18	53.9
—	—	UC320 to UC324	M18×1.5 ×20	58.8
—	—	UC326 to UC328	M20×1.5 ×25	78.4

B) Inch series, applied to inch bore size.

Designation of the bearings for the unit to which torques given are applicable			Designation of set screws	Tightening torques lbf·inch(max.)
UC201 to UC205	—	—	No.10-32UNF	34
UC206	—	UC305 to UC306	¼-28UNF	43
UC207	UCX05	—	¼-28UNF	52
UC208 to UC210	—	—	⅝-24UNF	69
UC211	UCX06 to UCX08	UC307	⅝-24UNF	86
UC212	UCX09	—	⅜-24UNF	147
UC213 to UC215	—	UC308 to UC309	⅜-24UNF	173
UC216	UCX10	—	⅜-24UNF	199
—	UCX11 to UCX12	—	⅜-24UNF	216
UC217 to UC218	UCX13 to UCX15	UC310 to UC314	½-20UNF	260
—	UCX16 to UCX17	—	½-20UNF	303
—	UCX18	UC315 to UC316	⅝-18UNF	303
—	UCX20	UC317 to UC319	⅝-18UNF	477
—	—	UC320	⅝-18UNF	520

Designation of the bearings of applicable units	Designation of set screws	Tightening torques N·m(max.)
AS201 to 205	M 5×0.8 × 7	3.4
AS206	M 6×0.75 × 8	4.4
AS207	M 6×0.75 × 8	4.9
AS208	M 8×1 ×10	6.8

Designation of the bearings for the unit to which torques given are applicable	Designation of set screws	Tightening torques lbf·inch(max.)
AS201 to 205	No.10-32UNF	30
AS206	¼-28UNF	39
AS207	¼-28UNF	43
AS208	⅝-24UNF	60

Contents of ball bearing units and ball bearings for bearing units

DIMENSION TABLE

Pages

Pages

Set screw type

Pillow block unit, cast housing	
UCP2	B4
UCP3	B10
UCPX	B16
UCPL2	B22
UCHP2	B26
UCUP2	B30
ASPL2	B34
Pillow block unit, pressed steel housing	
ASPP2	B38
ASRPP2	B40
Square flanged unit, cast housing	
UCF2	B42
UCF3	B48
UCFX	B54
UCFS3	B60
Round flanged unit, cast housing	
UCFC2	B66
UCFCX	B72
Rhombus flanged unit, cast housing	
UCFL2	B78
UCFL3	B84
UCFLX	B90
UCFA2	B92
UCFH2	B96
ASFB2	B100
ASFD2	B102
Round flanged unit, pressed steel housing	
ASPF2	B104
ASRPF2	B106
Rhombus flanged unit, pressed steel housing	
ASPFL2	B108
Hanger unit, cast housing	
UCHB2	B110

Take-up unit, cast housing	
UCT2	B114
UCT3	B120
UCTX	B126
Take-up stretcher units	
UCT2-	B130
Take-up type L stretcher units	
UCL2-	B132
Take-up type M stretcher units	
UCM2-	B134
UCM3-	B136
Take-up mini stretcher units	
ASPT2-	B138
Cartridge unit, cast housing	
UCC2	B140
UCC3	B142
UCCX	B146

Eccentric locking collar type

Pillow block unit, cast housing	
UELPL2	B148
UELPL3	B152
UELPL2	B158
UELHP2	B162
UELUP2	B164
AELPL2	B166
JELPL2	B168
Pillow block unit, pressed steel housing	
AELPP2	B170
AELRPP2	B172
Square flanged unit, cast housing	
UELFL2	B174
UELFL3	B178
UELFLU2	B184
UELFS3	B188
Round flanged unit, cast housing	
UELFC2	B194

Pages

Pages

Rhombus flanged unit, cast housing	
UELFL2	B198
UELFL3	B202
UELFLU2	B208
AELFB2	B212
AELFD2	B214
JELFD2	B216
Round flanged unit, pressed steel housing	
AELPF2	B218
JELPF2	B220
AELRPF2	B222
Rhombus flanged unit, pressed steel housing	
AELPFL2	B224
JELPFL2	B226
Take-up unit, cast housing	
UELTL2	B228
UELTL3	B232
Take-up mini stretcher units	
AELPT2-	B238
JELPT2-	B240
Cartridge unit, cast housing	
UELCL2	B242
UELCL3	B244
Pillow block unit, cast housing	
UKP2	B248
UKP3	B252
UKPX	B256
Square flanged unit, cast housing	
UKF2	B260
UKF3	B264
UKFX	B268
UKFS3	B272
Round flanged unit, cast housing	
UKFC2	B276
UKFCX	B280

Rhombus flanged unit, cast housing	
UKFL2	B284
UKFL3	B288
UKFLX	B292

Take-up unit, cast housing	
UKT2	B294
UKT3	B298
UKTX	B302

Cartridge unit, cast housing	
UKC2	B306
UKC3	B308
UKCX	B310

Ball bearings

Set screw type	
UC2	B312
UC3	B318
UCX	B324
AS2	B328
AR2	B332

Eccentric locking collar type	
UEL2	B336
UEL3	B340
AEL2	B346
JEL2	B348
REL2	B350

Adapter type

Adapter type	
UK2	B354
UK3	B358
UKX	B362

Other bearings	
UCS2	B366
UCS3	B370
ASS2	B374
UELS2	B376
UELS3	B380
AELS2	B384
JELS2	B386
CS2	B388

Pillow block unit, cast housing Set screw type

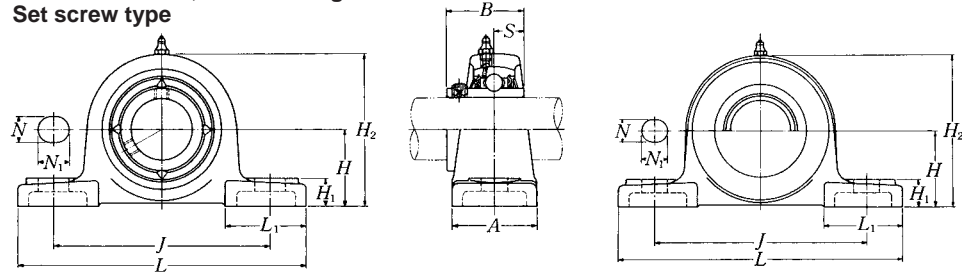

Pressed steel dust cover type
Open end **Z-UCP...D1**
Closed end **ZM-UCP...D1**

Shaft dia. mm inch	Unit number (1)	Nominal dimensions											Bolt size mm inch	Bearing number
		mm inch												
		H	L	J	A	N	N ₁	H ₁	H ₂	L ₁	B	S		
12 1/2	UCP201D1	30.2	127	95	38	13	16	14	62	42	31	12.7	M10 3/8	UC201D1 UC201-008D1
	UCP201-008D1	1 3/16	5	3 3/4	1 1/2	1/2	5/8	9/16	2 7/16	1 21/32	1.2205	0.500		
15 9/16 5/8	UCP202D1	30.2	127	95	38	13	16	14	62	42	31	12.7	M10 3/8	UC202D1 UC202-009D1 UC202-010D1
	UCP202-009D1 UCP202-010D1	1 3/16	5	3 3/4	1 1/2	1/2	5/8	9/16	2 7/16	1 21/32	1.2205	0.500		
17 11/16	UCP203D1	30.2	127	95	38	13	16	14	62	42	31	12.7	M10 3/8	UC203D1 UC203-011D1
	UCP203-011D1	1 3/16	5	3 3/4	1 1/2	1/2	5/8	9/16	2 7/16	1 21/32	1.2205	0.500		
20 3/4	UCP204D1	33.3	127	95	38	13	16	14	65	42	31	12.7	M10 3/8	UC204D1 UC204-012D1
	UCP204-012D1	1 5/16	5	3 3/4	1 1/2	1/2	5/8	9/16	2 9/16	1 21/32	1.2205	0.500		
25 13/16 7/8 15/16 1	UCP205D1	36.5	140	105	38	13	16	15	71	42	34.1	14.3	M10 3/8	UC205D1 UC205-013D1 UC205-014D1 UC205-015D1 UC205-100D1
	UCP205-013D1	1 7/16	5 1/2	4 1/8	1 1/2	1/2	5/8	19/32	2 25/32	1 21/32	1.3425	0.563		
	UCP205-014D1													
	UCP205-015D1													
	UCP205-100D1													
30 1 1/16 1 1/8 1 3/16 1 1/4	UCP206D1	42.9	165	121	48	17	20	17	83	54	38.1	15.9	M14 1/2	UC206D1 UC206-101D1 UC206-102D1 UC206-103D1 UC206-104D1
	UCP206-101D1	1 11/16	6 1/2	4 3/4	1 7/8	21/32	25/32	21/32	3 9/32	2 1/8	1.5000	0.626		
	UCP206-102D1													
	UCP206-103D1 UCP206-104D1													
35 1 1/4 1 5/16 1 3/8 1 7/16	UCP207D1	47.6	167	127	48	17	20	18	93	54	42.9	17.5	M14 1/2	UC207D1 UC207-104D1 UC207-105D1 UC207-106D1 UC207-107D1
	UCP207-104D1	1 7/8	6 9/16	5	1 7/8	21/32	25/32	23/32	3 21/32	2 1/8	1.6890	0.689		
	UCP207-105D1													
	UCP207-106D1													
	UCP207-107D1													
40 1 1/2 1 5/16	UCP208D1	49.2	184	137	54	17	20	18	98	52	49.2	19	M14 1/2	UC208D1 UC208-108D1 UC208-109D1
	UCP208-108D1	1 15/16	7 1/4	5 13/32	2 1/8	21/32	25/32	23/32	3 27/32	2 1/16	1.9370	0.748		
	UCP208-109D1													
45 1 5/8 1 11/16 1 3/4	UCP209D1	54	190	146	54	17	20	20	106	60	49.2	19	M14 1/2	UC209D1 UC209-110D1 UC209-111D1 UC209-112D1
	UCP209-110D1	2 1/8	7 15/32	5 3/4	2 1/8	21/32	25/32	25/32	4 3/16	2 3/8	1.9370	0.748		
	UCP209-111D1													
	UCP209-112D1													

Note (1) These numbers indicate relubricatable type. If maintenance free type is needed, please order without suffix "D1".
Remarks Please refer to page A21 for size of grease fitting.

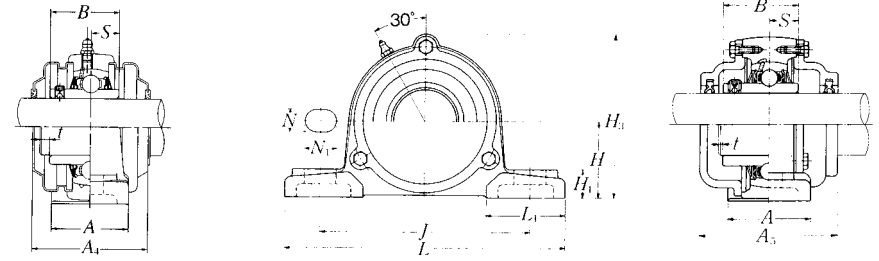

Cast dust cover type
Open end **C-UCP...D1**
Closed end **CM-UCP...D1**

Housing number	Unit number (1) pressed steel dust cover type	Unit number (1) cast dust cover type	Nominal dimensions				Mass of unit		
			mm inch				kg lb		
			t max.	A ₄	H ₃	A ₅	UCP	Z(ZM)	C(CM)
P203D1	Z(ZM)-UCP201D1	C(CM)-UCP201D1	2	45	67	62	0.7	0.7	1.0
	Z(ZM)-UCP201-008D1	C(CM)-UCP201-008D1	5/64	1 25/32	2 5/8	2 7/16	1.5	1.5	2.2
P203D1	Z(ZM)-UCP202D1	C(CM)-UCP202D1	2	45	67	62	0.7	0.7	1.0
	Z(ZM)-UCP202-009D1 Z(ZM)-UCP202-010D1	C(CM)-UCP202-009D1 C(CM)-UCP202-010D1	5/64	1 25/32	2 5/8	2 7/16	1.5	1.5	2.2
P203D1	Z(ZM)-UCP203D1	C(CM)-UCP203D1	2	45	67	62	0.7	0.7	1.0
	Z(ZM)-UCP203-011D1	C(CM)-UCP203-011D1	5/64	1 25/32	2 5/8	2 7/16	1.5	1.5	2.2
P204D1	Z(ZM)-UCP204D1	C(CM)-UCP204D1	2	45	70	62	0.7	0.7	0.9
	Z(ZM)-UCP204-012D1	C(CM)-UCP204-012D1	5/64	1 25/32	2 3/4	2 7/16	1.5	1.5	2.0
P205D1	Z(ZM)-UCP205D1	C(CM)-UCP205D1	2	48	76	70	0.8	0.9	1.1
	Z(ZM)-UCP205-013D1	C(CM)-UCP205-013D1	5/64	1 29/32	3	2 3/4	1.8	2.0	2.4
	Z(ZM)-UCP205-014D1								
	Z(ZM)-UCP205-015D1								
	Z(ZM)-UCP205-100D1								
P206D1	Z(ZM)-UCP206D1	C(CM)-UCP206D1	2	53	88	75	1.4	1.4	1.7
	Z(ZM)-UCP206-101D1	C(CM)-UCP206-101D1	5/64	2 3/32	3 15/32	2 15/16	3.1	3.1	3.7
	Z(ZM)-UCP206-102D1								
	Z(ZM)-UCP206-103D1 —								
P207D1	Z(ZM)-UCP207D1	C(CM)-UCP207D1	3	60	99	80	1.6	1.7	2.0
	Z(ZM)-UCP207-104D1	C(CM)-UCP207-104D1	1/8	2 3/8	3 29/32	3 5/32	3.5	3.7	4.4
	Z(ZM)-UCP207-105D1								
	Z(ZM)-UCP207-106D1								
	—								
P208D1	Z(ZM)-UCP208D1	C(CM)-UCP208D1	3	69	105	90	1.9	2.1	2.7
	Z(ZM)-UCP208-108D1	C(CM)-UCP208-108D1	1/8	2 29/32	4 1/8	3 17/32	4.2	4.6	6.0
	Z(ZM)-UCP208-109D1								
P209D1	Z(ZM)-UCP209D1	C(CM)-UCP209D1	3	69	113	95	2.2	2.4	3.1
	Z(ZM)-UCP209-110D1	C(CM)-UCP209-110D1	1/8	2 23/32	4 7/16	3 3/4	4.9	5.3	6.8
	Z(ZM)-UCP209-111D1								
	Z(ZM)-UCP209-112D1								

Pillow block unit, cast housing Set screw type

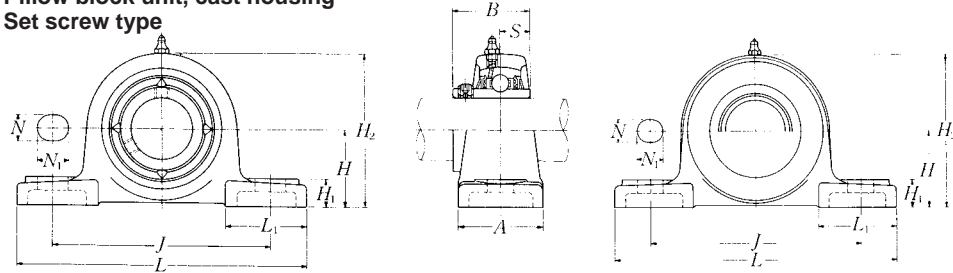

Pressed steel dust cover type
Open end **Z-UCP...D1**
Closed end **ZM-UCP...D1**

Shaft dia. mm inch	Unit number (1)	Nominal dimensions											Bolt size mm inch	Bearing number
		H	L	J	A	N	N ₁	H ₁	H ₂	L ₁	B	S		
50 1 3/16 1 7/8 1 5/16 2	UCP210D1 UCP210-113D1 UCP210-114D1 UCP210-115D1 UCP210-200D1	57.2	206	159	60	20	23	21	114	65	51.6	19	M16	UC210D1 UC210-113D1 UC210-114D1 UC210-115D1 UC210-200D1
55 2 2 1/16 2 1/8 2 3/16	UCP211D1 UCP211-200D1 UCP211-201D1 UCP211-202D1 UCP211-203D1	63.5	219	171	60	20	23	23	126	65	55.6	22.2	M16	UC211D1 UC211-200D1 UC211-201D1 UC211-202D1 UC211-203D1
60 2 1/4 2 1/16 2 3/8 2 7/16	UCP212D1 UCP212-204D1 UCP212-205D1 UCP212-206D1 UCP212-207D1	69.8	241	184	70	20	23	25	138	70	65.1	25.4	M16	UC212D1 UC212-204D1 UC212-205D1 UC212-206D1 UC212-207D1
65 2 1/2 2 9/16	UCP213D1 UCP213-208D1 UCP213-209D1	76.2	265	203	70	25	28	27	151	77	65.1	25.4	M20	UC213D1 UC213-208D1 UC213-209D1
70 2 5/8 2 1/16 2 3/4	UCP214D1 UCP214-210D1 UCP214-211D1 UCP214-212D1	79.4	266	210	72	25	28	27	157	77	74.6	30.2	M20	UC214D1 UC214-210D1 UC214-211D1 UC214-212D1
75 2 13/16 2 7/8 2 15/16 3	UCP215D1 UCP215-213D1 UCP215-214D1 UCP215-215D1 UCP215-300D1	82.6	275	217	74	25	28	28	163	80	77.8	33.3	M20	UC215D1 UC215-213D1 UC215-214D1 UC215-215D1 UC215-300D1
80 3 1/16 3 1/8 3 1/16	UCP216D1 UCP216-301D1 UCP216-302D1 UCP216-303D1	88.9	292	232	78	25	28	30	175	85	82.6	33.3	M20	UC216D1 UC216-301D1 UC216-302D1 UC216-303D1

Note (1) These numbers indicate relubricatable type. If maintenance free type is needed, please order without suffix "D1".

Remarks Please refer to page A21 for size of grease fitting.

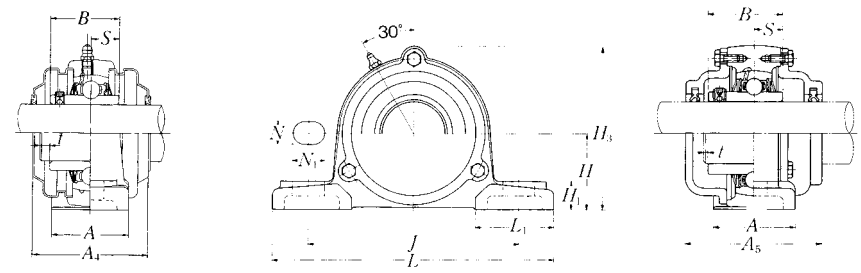

Cast dust cover type
Open end **C-UCP...D1**
Closed end **CM-UCP...D1**

Housing number	Unit number (1) pressed steel dust cover type	Unit number (1) cast dust cover type	Nominal dimensions				Mass of unit		
			t max.	A ₄	H ₃	A ₅	UCP	Z(ZM)	C(CM)
P210D1 P210D1 P210D1 P210D1 P210D1	Z(ZM)-UCP210D1 Z(ZM)-UCP210-113D1 Z(ZM)-UCP210-114D1 Z(ZM)-UCP210-115D1 —	C(CM)-UCP210D1 C(CM)-UCP210-113D1 C(CM)-UCP210-114D1 C(CM)-UCP210-115D1 C(CM)-UCP210-200D1	3 1/8	76 3	119 4 11/16	100 3 15/16	2.7 6.0	2.8 6.2	3.6 7.9
P211D1 P211D1 P211D1 P211D1 P211D1	Z(ZM)-UCP211D1 Z(ZM)-UCP211-200D1 Z(ZM)-UCP211-201D1 Z(ZM)-UCP211-202D1 Z(ZM)-UCP211-203D1	C(CM)-UCP211D1 C(CM)-UCP211-200D1 C(CM)-UCP211-201D1 C(CM)-UCP211-202D1 C(CM)-UCP211-203D1	4 5/32	77 3 1/2	130 5 1/8	100 3 15/16	3.5 7.7	3.5 7.7	4.4 9.7
P212D1 P212D1 P212D1 P212D1 P212D1	Z(ZM)-UCP212D1 Z(ZM)-UCP212-204D1 Z(ZM)-UCP212-205D1 Z(ZM)-UCP212-206D1 —	C(CM)-UCP212D1 C(CM)-UCP212-204D1 C(CM)-UCP212-205D1 C(CM)-UCP212-206D1 C(CM)-UCP212-207D1	4 5/32	89 3 1/2	143 5 5/8	115 4 17/32	4.7 10	5.0 11	6.0 13
P213D1 P213D1 P213D1	Z(ZM)-UCP213D1 Z(ZM)-UCP213-208D1 Z(ZM)-UCP213-209D1	C(CM)-UCP213D1 C(CM)-UCP213-208D1 C(CM)-UCP213-209D1	4 5/32	91 3 19/32	155 6 3/32	120 4 23/32	5.6 12	5.8 13	7.2 16
P214D1 P214D1 P214D1 P214D1	— — — —	C(CM)-UCP214D1 C(CM)-UCP214-210D1 C(CM)-UCP214-211D1 C(CM)-UCP214-212D1	4 5/32	— 6 3/8	162 5 5/16	135 5 5/16	6.5 14	— —	8.3 18
P215D1 P215D1 P215D1 P215D1 P215D1	— — — — —	C(CM)-UCP215D1 C(CM)-UCP215-213D1 C(CM)-UCP215-214D1 C(CM)-UCP215-215D1 C(CM)-UCP215-300D1	4 5/32	— 6 5/8	168 5 5/16	135 5 5/16	7.2 16	— —	9.3 21
P216D1 P216D1 P216D1 P216D1	— — — —	C(CM)-UCP216D1 C(CM)-UCP216-301D1 C(CM)-UCP216-302D1 C(CM)-UCP216-303D1	4 5/32	— 7 1/8	181 5 23/32	145	8.7 19	— —	11 24

UCP2

Pillow block unit, cast housing Set screw type

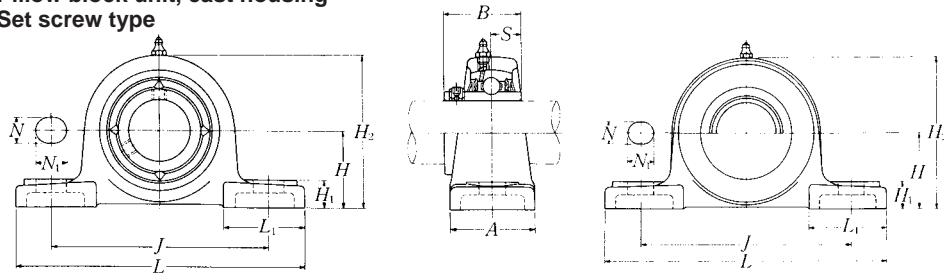

Pressed steel dust cover type
Open end **Z-UCP...D1**
Closed end **ZM-UCP...D1**

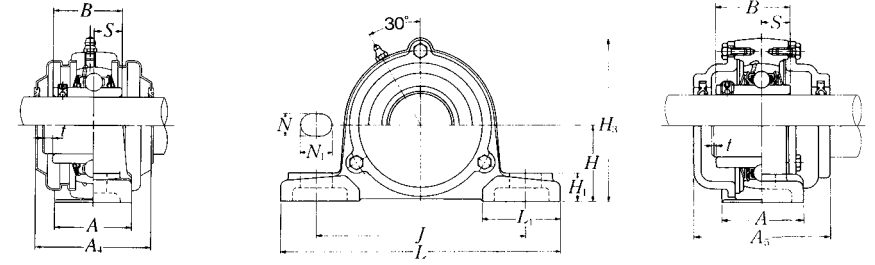

Cast dust cover type
Open end **C-UCP...D1**
Closed end **CM-UCP...D1**

Shaft dia. mm inch	Unit number (1)	Nominal dimensions											Bolt size mm inch	Bearing number
		mm inch												
		H	L	J	A	N	N ₁	H ₁	H ₂	L ₁	B	S		
85 3 1/4 3 5/16 3 7/16	UCP217D1 UCP217-304D1 UCP217-305D1 UCP217-307D1	95.2	310	247	83	25	28	32	187	85	85.7	34.1	M20	UC217D1 UC217-304D1 UC217-305D1 UC217-307D1
90 3 1/2	UCP218D1 UCP218-308D1	101.6	327	262	88	27	30	33	200	90	96	39.7	M22	UC218D1 UC218-308D1

Note (1) These numbers indicate relubricatable type. If maintenance free type is needed, please order without suffix "D1".
Remarks Please refer to page **A21** for size of grease fitting.

Housing number	Unit number (1) pressed steel dust cover type	Unit number (1) cast dust cover type	Nominal dimensions				Mass of unit		
			mm inch				kg lb		
			t max.	A ₄	H ₃	A ₅	UCP	Z(ZM)	C(CM)
P217D1 P217D1 P217D1 P217D1	— — — —	C(CM)-UCP217D1 C(CM)-UCP217-304D1 C(CM)-UCP217-305D1 C(CM)-UCP217-307D1	5 13/64	— —	191 7 17/32	155 6 3/32	11 24	— —	13 29
P218D1 P218D1	— —	C(CM)-UCP218D1 C(CM) UCP218-308D1	5 13/64	— —	204 8 1/32	165 6 1/2	13 29	— —	16 35

Pillow block unit, cast housing Set screw type

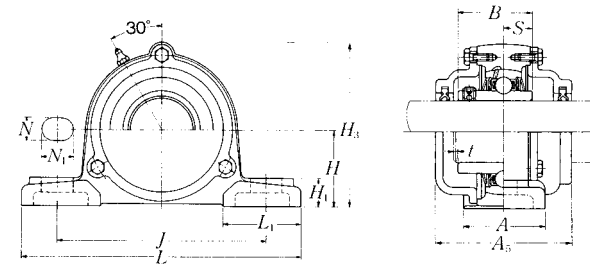
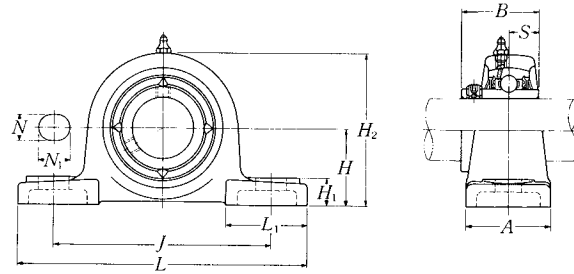

Cast dust cover type
Open end **C-UCP...D1**
Closed end **CM-UCP...D1**

Shaft dia. mm inch	Unit number (1)	Nominal dimensions											Bolt size mm inch
		mm inch											
		H	L	J	A	N	N ₁	H ₁	H ₂	L ₁	B	S	
25 1 3/16 7/8 15/16	UCP305D1 UCP305-013D1 UCP305-014D1 UCP305-015D1 UCP305-100D1	45 1 49/64	175 6 7/8	132 5 3/16	45 1 25/32	17 21/32	20 25/32	15 19/32	85 3 11/32	54 2 1/8	38 1.4961	15 0.591	M14 1/2
30 1 1/16 1 1/8 1 3/16	UCP306D1 UCP306-101D1 UCP306-102D1 UCP306-103D1	50 1 31/32	180 7 3/32	140 5 1/2	50 1 31/32	17 21/32	20 25/32	18 23/32	95 3 3/4	54 2 1/8	43 1.6929	17 0.669	M14 1/2
35 1 1/4 1 5/16 1 3/8 1 7/16	UCP307D1 UCP307-104D1 UCP307-105D1 UCP307-106D1 UCP307-107D1	56 2 13/64	210 8 9/32	160 6 5/16	56 2 7/32	17 21/32	25 31/32	20 25/32	106 4 3/16	60 2 3/8	48 1.8898	19 0.748	M14 1/2
40 1 1/2 1 7/16	UCP308D1 UCP308-108D1 UCP308-109D1	60 2 23/64	220 8 21/32	170 6 11/16	60 2 3/8	17 21/32	27 1 1/16	22 7/8	116 4 9/16	60 2 3/8	52 2.0472	19 0.748	M14 1/2
45 1 5/8 1 11/16 1 3/4	UCP309D1 UCP309-110D1 UCP309-111D1 UCP309-112D1	67 2 41/64	245 9 21/32	190 7 15/32	67 2 5/8	20 25/32	30 1 3/16	24 15/16	129 5 3/32	65 2 9/16	57 2.2441	22 0.866	M16 5/8
50 1 13/16 1 7/8 1 15/16	UCP310D1 UCP310-113D1 UCP310-114D1 UCP310-115D1	75 2 61/64	275 10 13/16	212 8 11/32	75 2 15/16	20 25/32	35 1 3/8	27 1 1/16	143 5 5/8	75 2 15/16	61 2.4016	22 0.866	M16 5/8
55 2 2 1/16 2 1/8 2 3/16	UCP311D1 UCP311-200D1 UCP311-201D1 UCP311-202D1 UCP311-203D1	80 3 5/32	310 12 7/32	236 9 9/32	80 3 5/32	20 25/32	38 1 1/2	30 1 3/16	154 6 1/16	85 3 11/32	66 2.5984	25 0.984	M16 5/8

Note (1) These numbers indicate relubricatable type. If maintenance free type is needed, please order without suffix "D1".
Remarks Please refer to page A21 for size of grease fitting.

Bearing number	Housing number	Unit number (1) cast dust cover type	Nominal dimensions			Mass of unit	
			mm inch			kg lb	
			t max.	H ₃	A ₅	UCP	C(CM)
UC305D1 UC305-013D1 UC305-014D1 UC305-015D1 UC305-100D1	P305D1 P305D1 P305D1 P305D1 P305D1	C(CM)-UCP305D1 C(CM)-UCP305-013D1 C(CM)-UCP305-014D1 C(CM)-UCP305-015D1 C(CM)-UCP305-100D1	2 5/64	91 3 19/32	80 3 5/32	1.4 3.1	1.8 4.0
UC306D1 UC306-101D1 UC306-102D1 UC306-103D1	P306D1 P306D1 P306D1 P306D1	C(CM)-UCP306D1 C(CM)-UCP306-101D1 C(CM)-UCP306-102D1 C(CM)-UCP306-103D1	2 5/64	105 4 1/8	85 3 11/32	1.8 4.0	2.5 5.5
UC307D1 UC307-104D1 UC307-105D1 UC307-106D1 UC307-107D1	P307D1 P307D1 P307D1 P307D1 P307D1	C(CM)-UCP307D1 C(CM)-UCP307-104D1 C(CM)-UCP307-105D1 C(CM)-UCP307-106D1 C(CM)-UCP307-107D1	3 1/8	115 4 17/32	95 3 3/4	2.5 5.5	3.2 7.1
UC308D1 UC308-108D1 UC308-109D1	P308D1 P308D1 P308D1	C(CM)-UCP308D1 C(CM)-UCP308-108D1 C(CM)-UCP308-109D1	3 1/8	125 4 29/32	105 4 1/8	3.1 6.8	4.0 8.8
UC309D1 UC309-110D1 UC309-111D1 UC309-112D1	P309D1 P309D1 P309D1 P309D1	C(CM)-UCP309D1 C(CM)-UCP309-110D1 C(CM)-UCP309-111D1 C(CM)-UCP309-112D1	3 1/8	140 5 1/2	110 4 11/32	4.1 9.0	5.4 12
UC310D1 UC310-113D1 UC310-114D1 UC310-115D1	P310D1 P310D1 P310D1 P310D1	C(CM)-UCP310D1 C(CM)-UCP310-113D1 C(CM)-UCP310-114D1 C(CM)-UCP310-115D1	3 1/8	156 6 5/32	120 4 23/32	5.6 12	7.0 15
UC311D1 UC311-200D1 UC311-201D1 UC311-202D1 UC311-203D1	P311D1 P311D1 P311D1 P311D1 P311D1	C(CM)-UCP311D1 C(CM)-UCP311-200D1 C(CM)-UCP311-201D1 C(CM)-UCP311-202D1 C(CM)-UCP311-203D1	4 5/32	166 6 17/32	125 4 29/32	7.3 16	8.8 19

Pillow block unit, cast housing Set screw type

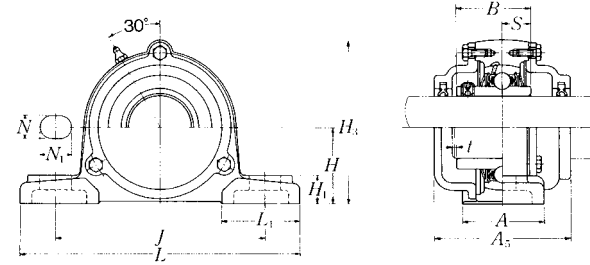
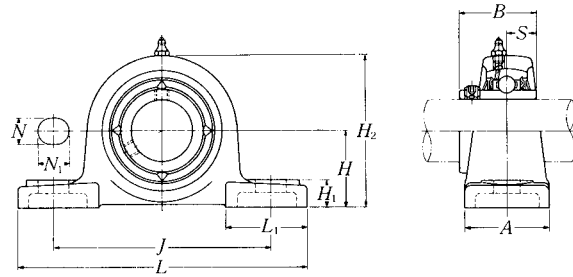

Cast dust cover type
Open end **C-UCP...D1**
Closed end **CM-UCP...D1**

Shaft dia. mm inch	Unit number (1)	Nominal dimensions											Bolt size mm inch
		mm inch											
		H	L	J	A	N	N ₁	H ₁	H ₂	L ₁	B	S	
60 2 1/4 2 5/16 2 3/8 2 7/16	UCP312D1 UCP312-204D1 UCP312-205D1 UCP312-206D1 UCP312-207D1	85	330	250	85	25	38	32	165	95	71	26	M20
		3 11/32	13	9 27/32	3 11/32	3 1/2	1 1/2	1 1/4	6 1/2	3 3/4	2.7953	1.024	3/4
65 2 1/2 2 9/16	UCP313D1 UCP313-208D1 UCP313-209D1	90	340	260	90	25	38	33	176	105	75	30	M20
		3 35/64	13 3/8	10 1/4	3 17/32	3 1/2	1 1/2	1 5/16	6 15/16	4 1/8	2.9528	1.181	3/4
70 2 5/8 2 11/16 2 3/4	UCP314D1 UCP314-210D1 UCP314-211D1 UCP314-212D1	95	360	280	90	27	40	35	187	105	78	33	M22
		3 47/64	14 3/16	11 1/32	3 17/32	1 1/16	1 9/16	1 3/8	7 3/8	4 1/8	3.0709	1.299	7/8
75 2 13/16 2 7/8 2 5/8 3	UCP315D1 UCP315-213D1 UCP315-214D1 UCP315-215D1 UCP315-300D1	100	380	290	100	27	40	35	198	110	82	32	M22
		3 15/16	14 31/32	11 13/32	3 15/16	1 1/16	1 9/16	1 3/8	7 25/32	4 11/32	3.2283	1.260	7/8
80 3 1/16 3 3/8 3 1/2	UCP316D1 UCP316-301D1 UCP316-302D1 UCP316-303D1	106	400	300	110	27	40	40	210	110	86	34	M22
		4 11/64	15 3/4	11 13/16	4 11/32	1 1/16	1 9/16	1 9/16	8 9/32	4 11/32	3.3858	1.339	7/8
85 3 1/4 3 5/16 3 7/16	UCP317D1 UCP317-304D1 UCP317-305D1 UCP317-307D1	112	420	320	110	33	45	40	220	120	96	40	M27
		4 13/32	16 17/32	12 19/32	4 11/32	1 5/16	1 25/32	1 9/16	8 21/32	4 23/32	3.7795	1.575	1
90 3 7/16 3 1/2	UCP318D1 UCP318-307D1 UCP318-308D1	118	430	330	110	33	45	45	235	120	96	40	M27
		4 41/64	16 15/16	13	4 11/32	1 5/16	1 25/32	1 25/32	9 1/4	4 23/32	3.7795	1.575	1

Note (1) These numbers indicate relubricatable type. If maintenance free type is needed, please order without suffix "D1".

Remarks Please refer to page A21 for size of grease fitting.

Bearing number	Housing number	Unit number (1) cast dust cover type	Nominal dimensions			Mass of unit	
			mm inch			kg lb	
			t max.	H ₃	A ₅	UCP	C(CM)
UC312D1 UC312-204D1 UC312-205D1 UC312-206D1 UC312-207D1	P312D1 P312D1 P312D1 P312D1 P312D1	C(CM)-UCP312D1 C(CM)-UCP312-204D1 C(CM)-UCP312-205D1 C(CM)-UCP312-206D1 C(CM)-UCP312-207D1	4 5/32	179 7 1/16	135 5 5/16	9.4 21	11 24
UC313D1 UC313-208D1 UC313-209D1	P313D1 P313D1 P313D1	C(CM)-UCP313D1 C(CM)-UCP313-208D1 C(CM)-UCP313-209D1	4 5/32	190 7 15/32	140 5 1/2	10 22	12 26
UC314D1 UC314-210D1 UC314-211D1 UC314-212D1	P314D1 P314D1 P314D1 P314D1	C(CM)-UCP314D1 C(CM)-UCP314-210D1 C(CM)-UCP314-211D1 C(CM)-UCP314-212D1	4 5/32	200 7 7/8	140 5 1/2	12 26	14 31
UC315D1 UC315-213D1 UC315-214D1 UC315-215D1 UC315-300D1	P315D1 P315D1 P315D1 P315D1 P315D1	C(CM)-UCP315D1 C(CM)-UCP315-213D1 C(CM)-UCP315-214D1 C(CM)-UCP315-215D1 C(CM)-UCP315-300D1	4 5/32	210 8 9/32	150 5 29/32	14 31	17 37
UC316D1 UC316-301D1 UC316-302D1 UC316-303D1	P316D1 P316D1 P316D1 P316D1	C(CM)-UCP316D1 C(CM)-UCP316-301D1 C(CM)-UCP316-302D1 C(CM)-UCP316-303D1	4 5/32	221 8 11/16	155 6 3/32	17 37	21 46
UC317D1 UC317-304D1 UC317-305D1 UC317-307D1	P317D1 P317D1 P317D1 P317D1	C(CM)-UCP317D1 C(CM)-UCP317-304D1 C(CM)-UCP317-305D1 C(CM)-UCP317-307D1	5 13/64	235 9 1/4	170 6 11/16	19 42	24 53
UC318D1 UC318-307D1 UC318-308D1	P318D1 P318D1 P318D1	C(CM)-UCP318D1 C(CM)-UCP318-307D1 C(CM)-UCP318-308D1	5 13/64	246 9 1/16	170 6 11/16	22 49	27 60

Pillow block unit, cast housing Set screw type

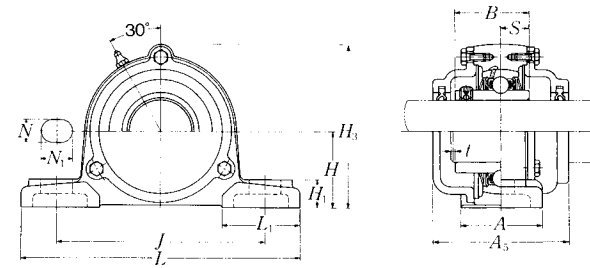
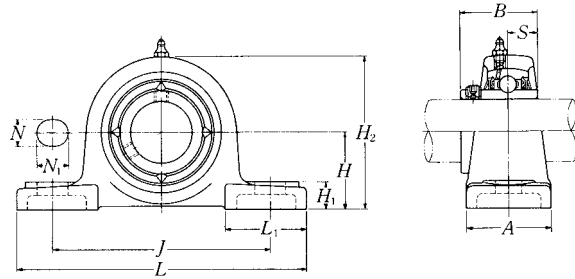

Cast dust cover type
Open end **C-UCP...D1**
Closed end **CM-UCP...D1**

Shaft dia. mm inch	Unit number (1)	Nominal dimensions											Bolt size mm inch
		mm inch											
		H	L	J	A	N	N ₁	H ₁	H ₂	L ₁	B	S	
95 3 5/8 3 1/16 3 3/4	UCP319D1 UCP319-310D1 UCP319-311D1 UCP319-312D1	125 4 59/64	470 18 1/2	360 14 3/16	120 4 23/32	36 1 13/32	50 1 31/32	45 1 25/32	250 9 27/32	125 4 29/32	103 4.0551	41 1.614	M30 1 1/8
100 3 13/16 3 7/8 3 15/16 4	UCP320D1 UCP320-313D1 UCP320-314D1 UCP320-315D1 UCP320-400D1	140 5 33/64	490 19 9/32	380 14 31/32	120 4 23/32	36 1 13/32	50 1 31/32	50 1 31/32	275 10 13/16	130 5 1/8	108 4.2520	42 1.654	M30 1 1/8
105	UCP321D1	140	490	380	120	36	50	50	280	130	112	44	M30
110	UCP322D1	150	520	400	140	40	55	55	300	135	117	46	M33
120	UCP324D1	160	570	450	140	40	55	65	320	140	126	51	M33
130	UCP326D1	180	600	480	140	40	55	75	355	140	135	54	M33
140	UCP328D1	200	620	500	140	40	55	75	390	140	145	59	M33

Note (1) These numbers indicate relubricatable type. If maintenance free type is needed, please order without suffix "D1".
Remarks Please refer to page A21 for size of grease fitting.

Bearing number	Housing number	Unit number (1) cast dust cover type	Nominal dimensions			Mass of unit	
			mm inch			kg lb	
			t max.	H ₃	A ₅	UCP	C(CM)
UC319D1	P319D1	C(CM)-UCP319D1	5	258	180	26	32
UC319-310D1	P319D1	C(CM)-UCP319-310D1					
UC319-311D1	P319D1	C(CM)-UCP319-311D1	13/64	10 5/32	7 3/32	57	71
UC319-312D1	P319D1	C(CM)-UCP319-312D1					
UC320D1	P320D1	C(CM)-UCP320D1	5	283	190	33	39
UC320-313D1	P320D1	C(CM)-UCP320-313D1					
UC320-314D1	P320D1	C(CM)-UCP320-314D1	13/64	11 5/32	7 15/32	73	86
UC320-315D1	P320D1	C(CM)-UCP320-315D1					
UC320-400D1	P320D1	C(CM)-UCP320-400D1					
UC321D1	P321D1	C(CM)-UCP321D1	5	290	195	35	42
UC322D1	P322D1	C(CM)-UCP322D1	5	313	200	43	52
UC324D1	P324D1	C(CM)-UCP324D1	5	335	215	50	67
UC326D1	P326D1	C(CM)-UCP326D1	6	375	225	69	83
UC328D1	P328D1	C(CM)-UCP328D1	6	407	235	84	99

Pillow block unit, cast housing Set screw type

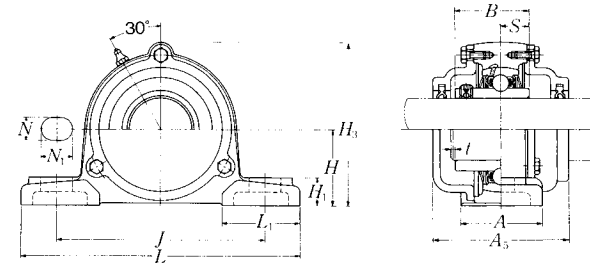
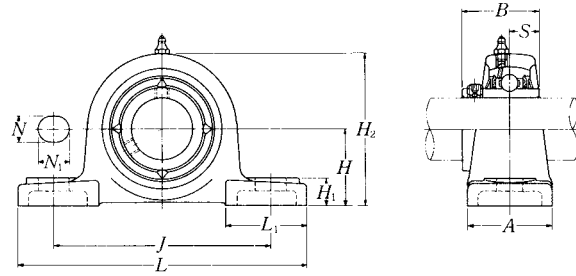

Cast dust cover type
Open end **C-UCP...D1**
Closed end **CM-UCP...D1**

Shaft dia. mm inch	Unit number (1)	Nominal dimensions											Bolt size mm inch
		mm inch											
		H	L	J	A	N	N ₁	H ₁	H ₂	L ₁	B	S	
25 1 13/16 7/8 15/16 1	UCPX05D1 UCPX05-013D1 UCPX05-014D1 UCPX05-015D1 UCPX05-100D1	44.4 1 3/4	159 6 1/4	119 4 11/16	51 2	17 2 1/2	20 25/32	18 23/32	85 3 11/32	50 1 31/32	38.1 1.5000	15.9 0.626	M14 1/2
30 1 1/16 1 1/8 1 3/16 1 1/4	UCPX06D1 UCPX06-101D1 UCPX06-102D1 UCPX06-103D1 UCPX06-104D1	47.6 1 7/8	175 6 7/8	127 5	57 2 1/4	17 2 1/32	20 25/32	20 25/32	93 3 21/32	54 2 1/8	42.9 1.6890	17.5 0.689	M14 1/2
35 1 5/16 1 3/8 1 7/16	UCPX07D1 UCPX07-105D1 UCPX07-106D1 UCPX07-107D1	54 2 1/8	203 8	144 5 21/32	57 2 1/4	17 2 1/32	20 25/32	21 19/16	105 4 1/8	60 2 3/8	49.2 1.9370	19 0.748	M14 1/2
40 1 1/2 1 7/16	UCPX08D1 UCPX08-108D1 UCPX08-109D1	58.7 2 5/16	222 8 3/4	156 6 5/32	67 2 5/8	20 25/32	23 29/32	26 1 1/32	111 4 3/8	65 2 9/16	49.2 1.9370	19 0.748	M16 5/8
45 1 5/8 1 11/16 1 3/4 1 13/16	UCPX09D1 UCPX09-110D1 UCPX09-111D1 UCPX09-112D1 UCPX09-113D1	58.7 2 5/16	222 8 3/4	156 6 5/32	67 2 5/8	20 25/32	23 29/32	26 1 1/32	116 4 9/16	65 2 9/16	51.6 2.0315	19 0.748	M16 5/8
50 1 7/8 1 15/16 2	UCPX10D1 UCPX10-114D1 UCPX10-115D1 UCPX10-200D1	63.5 2 1/2	241 9 1/2	171 6 23/32	73 2 7/8	20 25/32	23 29/32	27 1 1/16	126 4 31/32	70 2 3/4	55.6 2.1890	22.2 0.874	M16 5/8

Note (1) These numbers indicate relubricatable type. If maintenance free type is needed, please order without suffix "D1".
Remarks Please refer to page A21 for size of grease fitting.

Bearing number	Housing number	Unit number (1) cast dust cover type	Nominal dimensions			Mass of unit	
			mm inch			kg lb	
			t max.	H ₃	A ₅	UCP	C(CM)
UCX05D1 UCX05-013D1 UCX05-014D1 UCX05-015D1 UCX05-100D1	PX05D1 PX05D1 PX05D1 PX05D1 PX05D1	C(CM)-UCPX05D1 C(CM)-UCPX05-013D1 C(CM)-UCPX05-014D1 C(CM)-UCPX05-015D1 C(CM)-UCPX05-100D1	2 5/64	89 3 1/2	75 2 15/16	1.4 3.1	1.8 4.0
UCX06D1 UCX06-101D1 UCX06-102D1 UCX06-103D1 UC207-104D1	PX06D1 PX06D1 PX06D1 PX06D1 PX06D1	C(CM)-UCPX06D1 C(CM)-UCPX06-101D1 C(CM)-UCPX06-102D1 C(CM)-UCPX06-103D1 C(CM)-UCPX06-104D1	2 5/64	99 3 29/32	80 3 3/32	1.9 4.2	2.4 5.3
UCX07D1 UCX07-105D1 UCX07-106D1 UCX07-107D1	PX07D1 PX07D1 PX07D1 PX07D1	C(CM)-UCPX07D1 C(CM)-UCPX07-105D1 C(CM)-UCPX07-106D1 C(CM)-UCPX07-107D1	3 1/8	110 4 1/32	90 3 17/32	2.4 5.3	3.3 7.3
UCX08D1 UCX08-108D1 UCX08-109D1	PX08D1 PX08D1 PX08D1	C(CM)-UCPX08D1 C(CM)-UCPX08-108D1 C(CM)-UCPX08-109D1	3 1/8	118 4 21/32	95 3 3/4	2.9 6.4	3.8 8.4
UCX09D1 UCX09-110D1 UCX09-111D1 UCX09-112D1 UC210-113D1	PX09D1 PX09D1 PX09D1 PX09D1 PX09D1	C(CM)-UCPX09D1 C(CM)-UCPX09-110D1 C(CM)-UCPX09-111D1 C(CM)-UCPX09-112D1 C(CM)-UCPX09-113D1	3 1/6	120 4 23/32	100 3 15/16	3.2 7.1	4.2 9.3
UCX10D1 UCX10-114D1 UCX10-115D1 UC211-200D1	PX10D1 PX10D1 PX10D1 PX10D1	C(CM)-UCPX10D1 C(CM)-UCPX10-114D1 C(CM)-UCPX10-115D1 C(CM)-UCPX10-200D1	3 1/8	130 5 1/8	100 3 15/16	4.1 9.0	5.4 12

Pillow block unit, cast housing Set screw type

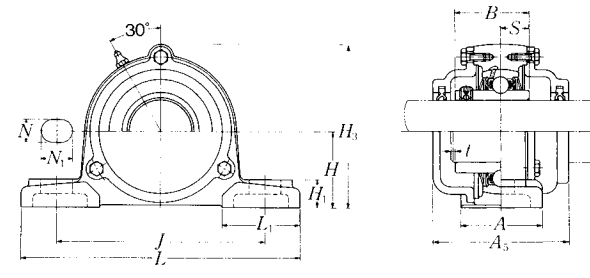
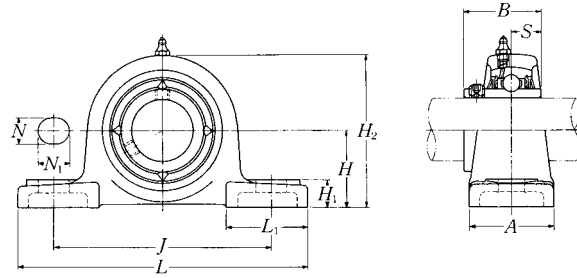

Cast dust cover type
Open end **C-UCP...D1**
Closed end **CM-UCP...D1**

Shaft dia. mm inch	Unit number (1)	Nominal dimensions											Bolt size mm inch
		mm inch											
		H	L	J	A	N	N ₁	H ₁	H ₂	L ₁	B	S	
55	UCPX11D1 UCPX11-201D1 UCPX11-202D1 UCPX11-203D1 UCPX11-204D1 UCPX11-205D1	69.8	260	184	79	25	28	30	137	75	65.1	25.4	M20
2 1/16 2 1/8 2 3/16 2 1/4 2 5/16		2 3/4	10 1/4	7 1/4	3 1/8	3 1/32	1 3/32	1 3/16	5 13/32	2 15/16	2.5630	1.000	3/4
60	UCPX12D1 UCPX12-206D1 UCPX12-207D1	76.2	286	203	83	25	28	33	151	80	65.1	25.4	M20
2 3/8 2 7/8 2 15/16		3	11 1/4	8	3 9/32	3 1/32	1 3/32	1 5/16	5 15/16	3 5/32	2.5630	1.000	3/4
65	UCPX13D1 UCPX13-208D1 UCPX13-209D1	76.2	286	203	83	25	28	33	154	80	74.6	30.2	M20
2 1/2 2 9/16		3	11 1/4	8	3 9/32	3 1/32	1 3/32	1 5/16	6 1/16	3 5/32	2.9370	1.189	3/4
70	UCPX14D1 UCPX14-210D1 UCPX14-211D1 UCPX14-212D1	88.9	330	229	89	27	30	35	170	95	77.8	33.3	M22
2 5/8 2 11/16 2 3/4		3 1/2	13	9 1/32	3 1/2	1 1/16	1 3/16	1 3/8	6 11/16	3 3/4	3.0630	1.311	7/8
75	UCPX15D1 UCPX15-213D1 UCPX15-214D1 UCPX15-215D1 UCPX15-300D1	88.9	330	229	89	27	30	35	175	95	82.6	33.3	M22
2 13/16 2 7/8 2 15/16 3		3 1/2	13	9 1/32	3 1/2	1 1/16	1 3/16	1 3/8	6 7/8	3 3/4	3.2520	1.311	7/8
80	UCPX16D1 UCPX16-301D1 UCPX16-302D1 UCPX16-303D1 UCPX16-304D1	101.6	381	283	102	27	30	40	194	110	85.7	34.1	M22
3 1/16 3 1/8 3 3/16 3 1/4		4	15	11 5/32	4 1/32	1 1/16	1 3/16	1 9/16	7 5/8	4 11/32	3.3740	1.343	7/8
85	UCPX17D1 UCPX17-305D1 UCPX17-307D1	101.6	381	283	102	27	30	40	200	110	96	39.7	M22
3 5/16 3 7/16		4	15	11 5/32	4 1/32	1 1/16	1 3/16	1 9/16	7 7/8	4 11/32	3.7795	1.563	7/8

Note (1) These numbers indicate relubricatable type. If maintenance free type is needed, please order without suffix "D1".

Remarks Please refer to page A21 for size of grease fitting.

Bearing number	Housing number	Unit number (1) cast dust cover type	Nominal dimensions			Mass of unit	
			mm inch			kg lb	
			t max.	H ₃	A ₅	UCP	C(CM)
UCX11D1	PX11D1	C(CM)-UCPX11D1	4	144	115	5.4	6.9
UCX11-201D1	PX11D1	C(CM)-UCPX11-201D1					
UCX11-202D1	PX11D1	C(CM)-UCPX11-202D1					
UCX11-203D1	PX11D1	C(CM)-UCPX11-203D1	5/32	5 21/32	4 17/32	12	15
UC212-204D1	PX11D1	C(CM)-UCPX11-204D1					
UC212-205D1	PX11D1	C(CM)-UCPX11-205D1					
UCX12D1	PX12D1	C(CM)-UCPX12D1	4	155	120	6.8	8.6
UCX12-206D1	PX12D1	C(CM)-UCPX12-206D1	5/32	6 3/32	4 23/32	15	19
UCX12-207D1	PX12D1	C(CM)-UCPX12-207D1					
UCX13D1	PX13D1	C(CM)-UCPX13D1	4	159	135	7.2	9.4
UCX13-208D1	PX13D1	C(CM)-UCPX13-208D1	5/32	6 1/4	5 5/16	16	21
UCX13-209D1	PX13D1	C(CM)-UCPX13-209D1					
UCX14D1	PX14D1	C(CM)-UCPX14D1	4	175	135	9.3	12
UCX14-210D1	PX14D1	C(CM)-UCPX14-210D1					
UCX14-211D1	PX14D1	C(CM)-UCPX14-211D1	5/32	6 7/8	5 5/16	21	26
UCX14-212D1	PX14D1	C(CM)-UCPX14-212D1					
UCX15D1	PX15D1	C(CM)-UCPX15D1	4	181	145	10	13
UCX15-213D1	PX15D1	C(CM)-UCPX15-213D1					
UCX15-214D1	PX15D1	C(CM)-UCPX15-214D1	5/32	7 1/8	5 23/32	22	29
UCX15-215D1	PX15D1	C(CM)-UCPX15-215D1					
UCX15-300D1	PX15D1	C(CM)-UCPX15-300D1					
UCX16D1	PX16D1	C(CM)-UCPX16D1	4	198	155	14	17
UCX16-301D1	PX16D1	C(CM)-UCPX16-301D1					
UCX16-302D1	PX16D1	C(CM)-UCPX16-302D1	5/32	7 25/32	6 3/32	31	37
UCX16-303D1	PX16D1	C(CM)-UCPX16-303D1					
UC217-304D1	PX16D1	C(CM)-UCPX16-304D1					
UCX17D1	PX17D1	C(CM)-UCPX17D1	5	204	165	15	19
UCX17-305D1	PX17D1	C(CM)-UCPX17-305D1	13/64	8 1/32	6 1/2	33	42
UCX17-307D1	PX17D1	C(CM)-UCPX17-307D1					

Pillow block unit, cast housing Set screw type

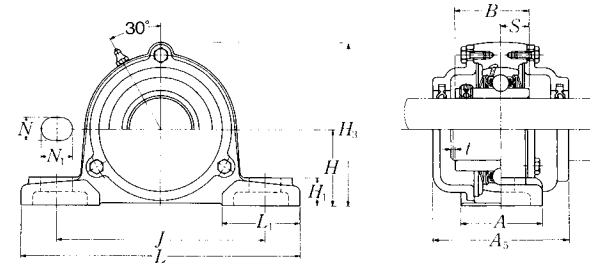
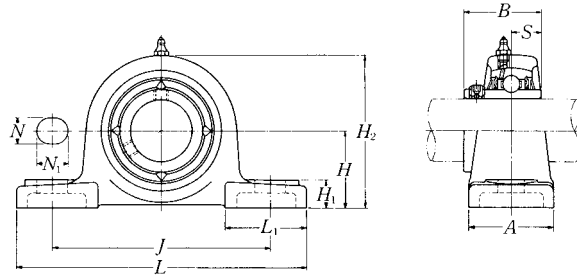

Cast dust cover type
Open end **C-UCP...D1**
Closed end **CM-UCP...D1**

Shaft dia. mm inch	Unit number (1)	Nominal dimensions											Bolt size mm inch
		mm inch											
		H	L	J	A	N	N ₁	H ₁	H ₂	L ₁	B	S	
90 3 7/16 3 1/2	UCPX18D1 UCPX18-307D1 UCPX18-308D1	101.6	381	283	111	27	30	40	206	110	104	42.9	M22
		4	15	11 5/32	4 3/8	1 1/16	1 3/16	1 9/16	8 1/8	4 11/32	4.0945	1.689	7/8
100 3 13/16 3 7/8 3 15/16 4	UCPX20D1 UCPX20-313D1 UCPX20-314D1 UCPX20-315D1 UCPX20-400D1	127	432	337	121	33	36	45	244	125	117.5	49.2	M27
		5	17	13 9/32	4 3/4	1 5/16	1 13/32	1 25/32	9 19/32	4 29/32	4.6260	1.937	1

Note (1) These numbers indicate relubricatable type. If maintenance free type is needed, please order without suffix "D1".
Remarks Please refer to page A21 for size of grease fitting.

Bearing number	Housing number	Unit number (1) cast dust cover type	Nominal dimensions			Mass of unit	
			mm inch			kg lb	
			t max.	H ₃	A ₃	UCP	C(CM)
UCX18D1 UCX18-307D1 UCX18-308D1	PX18D1 PX18D1 PX18D1	C(CM)-UCPX18D1 C(CM)-UCPX18-307D1 C(CM)-UCPX18-308D1	5 13/64	208 8 3/16	180 7 3/32	16 35	21 46
UCX20D1 UCX20-313D1 UCX20-314D1 UCX20-315D1 UCX20-400D1	PX20D1 PX20D1 PX20D1 PX20D1 PX20D1	C(CM)-UCPX20D1 C(CM)-UCPX20-313D1 C(CM)-UCPX20-314D1 C(CM)-UCPX20-315D1 C(CM)-UCPX20-400D1	5 13/64	244 9 19/32	195 7 11/16	25 55	29 64

Pillow block unit, cast housing low center height Set screw type

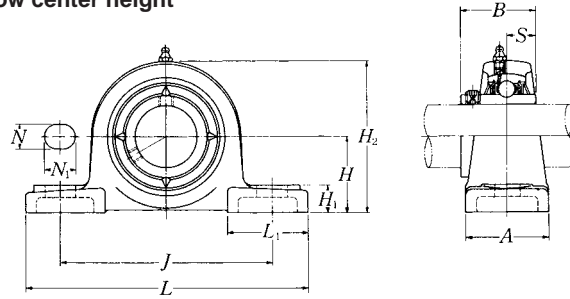

Shaft dia. mm inch	Unit number ⁽¹⁾ (²)(³)	Nominal dimensions											Bolt size mm inch
		mm inch											
		H	L	J	A	N	N ₁	H ₁	H ₂	L ₁	B	S	
20 3/4	UCPL204D1	31.75	127	95	38	13	16	14	64	42	31	12.7	M10
	UCPL204-012D1	1 1/4	5	3 3/4	1 1/2	1/2	5/8	9/16	2 1/2	1 21/32	1.2205	0.500	3/8
25 1 3/16 7/8 15/16 1	UCPL205D1	33.34	140	105	38	13	16	15	68	42	34.1	14.3	M10
	UCPL205-013D1	1 5/16	5 1/2	4 1/8	1 1/2	1/2	5/8	19/32	2 1/16	1 21/32	1.3425	0.563	3/8
	UCPL205-014D1												
	UCPL205-015D1												
UCPL205-100D1													
30 1 1/16 1 1/8 1 3/16 1 1/4	UCPL206D1	39.69	165	121	48	17	20	17	80	54	38.1	15.9	M14
	UCPL206-101D1	1 9/16	6 1/2	4 3/4	1 7/8	21/32	25/32	21/32	3 5/32	2 1/8	1.5000	0.626	1/2
	UCPL206-102D1												
	UCPL206-103D1												
UCPL206-104D1													
35 1 1/4 1 5/16 1 3/8 1 7/16	UCPL207D1	46.04	167	127	48	17	20	18	91	54	42.9	17.5	M14
	UCPL207-104D1	1 13/16	6 9/16	5	1 7/8	21/32	25/32	23/32	3 19/32	2 1/8	1.6890	0.689	1/2
	UCPL207-105D1												
	UCPL207-106D1												
UCPL207-107D1													
45 1 5/8 1 11/16 1 3/4	UCPL209D1	52.39	190	146	54	17	20	20	104	60	49.2	19	M14
	UCPL209-110D1	2 1/16	7 15/32	5 3/4	2 1/8	21/32	25/32	25/32	4 3/32	2 3/8	1.9370	0.748	1/2
	UCPL209-111D1												
UCPL209-112D1													
50 1 13/16 1 7/8 1 15/16 2	UCPL210D1	55.56	206	159	60	20	23	21	112	65	51.6	19	M16
	UCPL210-113D1	2 3/16	8 1/8	6 1/4	2 3/8	25/32	29/32	13/16	4 13/32	2 9/16	2.0315	0.748	5/8
	UCPL210-114D1												
	UCPL210-115D1												
UCPL210-200D1													

Notes (1) These numbers indicate relubricatable type. If maintenance free type is needed, please order without suffix "D1".

(2) UCPL204 and UCPL205 has solid bases.

(3) UCPL208 has the same dimension as UCP208 shown in page B4.

Remarks Please refer to page A21 for size of grease fitting.

Bearing number	Housing number	Mass of unit kg lb
UC204D1	PL204D1	0.7
UC204-012D1	PL204D1	1.5
UC205D1	PL205D1	0.8
UC205-013D1	PL205D1	1.8
UC205-014D1	PL205D1	
UC205-015D1	PL205D1	
UC205-100D1	PL205D1	
UC206D1	PL206D1	1.3
UC206-101D1	PL206D1	2.9
UC206-102D1	PL206D1	
UC206-103D1	PL206D1	
UC206-104D1	PL206D1	
UC207D1	PL207D1	1.6
UC207-104D1	PL207D1	3.5
UC207-105D1	PL207D1	
UC207-106D1	PL207D1	
UC207-107D1	PL207D1	
UC209D1	PL209D1	2.2
UC209-110D1	PL209D1	4.9
UC209-111D1	PL209D1	
UC209-112D1	PL209D1	
UC210D1	PL210D1	2.8
UC210-113D1	PL210D1	6.2
UC210-114D1	PL210D1	
UC210-115D1	PL210D1	
UC210-200D1	PL210D1	

UCPL2

Pillow block unit, cast housing low center height Set screw type

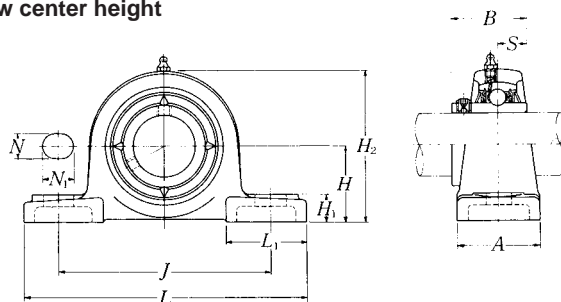

Shaft dia. mm inch	Unit number ⁽¹⁾	Nominal dimensions											Bolt size mm inch
		H	L	J	A	N	N ₁	H ₁	H ₂	L ₁	B	S	
55	UCPL211D1	61.91	219	171	60	20	23	23	124	65	55.6	22.2	M16
2	UCPL211-200D1	2 ⁷ / ₁₆	8 ⁵ / ₈	6 ²³ / ₃₂	2 ³ / ₈	25 ¹ / ₃₂	29 ¹ / ₃₂	29 ¹ / ₃₂	4 ⁷ / ₈	2 ⁹ / ₁₆	2.1890	0.874	5 ⁷ / ₈
2 ¹ / ₁₆	UCPL211-201D1												
2 ¹ / ₈	UCPL211-202D1												
2 ³ / ₁₆	UCPL211-203D1												
60	UCPL212D1	68.26	241	184	70	20	23	25	136	70	65.1	25.4	M16
2 ¹ / ₄	UCPL212-204D1	2 ¹¹ / ₁₆	9 ¹ / ₂	7 ¹ / ₄	2 ³ / ₄	25 ¹ / ₃₂	29 ¹ / ₃₂	31 ¹ / ₃₂	5 ¹¹ / ₃₂	2 ³ / ₄	2.5630	1.000	5 ⁷ / ₈
2 ⁵ / ₁₆	UCPL212-205D1												
2 ³ / ₈	UCPL212-206D1												
2 ⁷ / ₁₆	UCPL212-207D1												

Note ⁽¹⁾ These numbers indicate relubricatable type. If maintenance free type is needed, please order without suffix "D1".

Remarks Please refer to page A21 for size of grease fitting.

Bearing number	Housing number	Mass of unit kg lb
UC211D1	PL211D1	3.4
UC211-200D1	PL211D1	7.5
UC211-201D1	PL211D1	
UC211-202D1	PL211D1	
UC211-203D1	PL211D1	
UC212D1	PL212D1	4.7
UC212-204D1	PL212D1	10
UC212-205D1	PL212D1	
UC212-206D1	PL212D1	
UC212-207D1	PL212D1	

UCHP2

Pillow block unit, cast housing high center height Set screw type

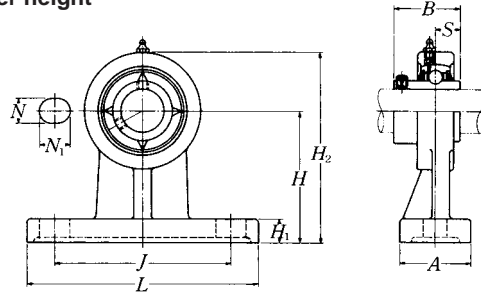

Shaft dia. mm inch	Unit number (1)	Nominal dimensions										Bolt size mm inch
		H	L	J	A	N	N ₁	H ₁	H ₂	B	S	
12 1/2	UCHP201D1	70	127	95	40	13	19	13	101	31	12.7	M10
	UCHP201-008D1	2 3/4	5	3 3/4	1 9/16	1/2	3/4	1/2	3 31/32	1.2205	0.500	3/8
15 9/16 5/8	UCHP202D1	70	127	95	40	13	19	13	101	31	12.7	M10
	UCHP202-009D1 UCHP202-010D1	2 3/4	5	3 3/4	1 9/16	1/2	3/4	1/2	3 31/32	1.2205	0.500	3/8
17 11/16	UCHP203D1	70	127	95	40	13	19	13	101	31	12.7	M10
	UCHP203-011D1	2 3/4	5	3 3/4	1 9/16	1/2	3/4	1/2	3 31/32	1.2205	0.500	3/8
20 3/4	UCHP204D1	70	127	95	40	13	19	13	101	31	12.7	M10
	UCHP204-012D1	2 3/4	5	3 3/4	1 9/16	1/2	3/4	1/2	3 31/32	1.2205	0.500	3/8
25 13/16 7/8 15/16 1	UCHP205D1	80	142	105	50	13	19	13	114	34.1	14.3	M10
	UCHP205-013D1	3 5/32	5 19/32	4 1/8	1 31/32	1/2	3/4	1/2	4 1/2	1.3425	0.563	3/8
	UCHP205-014D1											
	UCHP205-015D1											
UCHP205-100D1												
30 1 1/16 1 1/8 1 3/16 1 1/4	UCHP206D1	90	165	120	50	17	21	16	130	38.1	15.9	M14
	UCHP206-101D1	3 35/64	6 1/2	4 23/32	1 31/32	2 1/32	1 5/16	5/8	5 1/8	1.5000	0.626	1/2
	UCHP206-102D1											
	UCHP206-103D1											
UCHP206-104D1												
35 1 1/4 1 5/16 1 3/8 1 7/16	UCHP207D1	95	166	127	60	17	21	18	140	42.9	17.5	M14
	UCHP207-104D1	3 47/64	6 17/32	5	2 3/8	2 1/32	1 5/16	2 3/32	5 1/2	1.6890	0.689	1/2
	UCHP207-105D1											
	UCHP207-106D1											
UCHP207-107D1												
40 1 1/2 1 9/16	UCHP208D1	100	184	136	70	17	21	20	150	49.2	19	M14
	UCHP208-108D1 UCHP208-109D1	3 15/16	7 1/4	5 11/32	2 3/4	2 1/32	1 5/16	2 5/32	5 29/32	1.9370	0.748	1/2

Note (1) These numbers indicate relubricatable type. If maintenance free type is needed, please order without suffix "D1".
Remarks Please refer to page A21 for size of grease fitting.

Bearing number	Housing number	Mass of unit kg lb
UC201D1	HP204D1	0.9
UC201-008D1	HP204D1	2.0
UC202D1	HP204D1	0.9
UC202-009D1	HP204D1	2.0
UC202-010D1	HP204D1	
UC203D1	HP204D1	0.9
UC203-011D1	HP204D1	2.0
UC204D1	HP204D1	0.9
UC204-012D1	HP204D1	2.0
UC205D1	HP205D1	1.2
UC205-013D1	HP205D1	2.6
UC205-014D1	HP205D1	
UC205-015D1	HP205D1	
UC205-100D1	HP205D1	
UC206D1	HP206D1	1.8
UC206-101D1	HP206D1	4.0
UC206-102D1	HP206D1	
UC206-103D1	HP206D1	
UC206-104D1	HP206D1	
UC207D1	HP207D1	2.3
UC207-104D1	HP207D1	5.1
UC207-105D1	HP207D1	
UC207-106D1	HP207D1	
UC207-107D1	HP207D1	
UC208D1	HP208D1	3.2
UC208-108D1	HP208D1	7.1
UC208-109D1	HP208D1	

UCHP2

Pillow block unit, cast housing high center height Set screw type

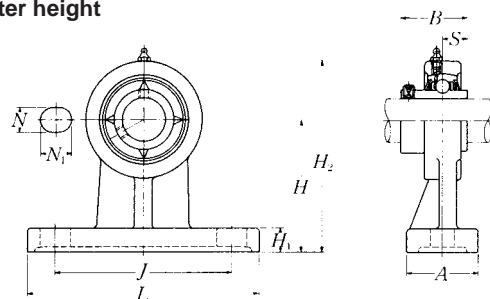

Shaft dia. mm inch	Unit number (1)	Nominal dimensions										Bolt size mm inch
		H	L	J	A	N	N ₁	H ₁	H ₂	B	S	
45 1 5/8 1 1/16 1 3/4	UCHP209D1 UCHP209-110D1 UCHP209-111D1 UCHP209-112D1	105	190	146	70	17	22	20	158	49.2	19	M14
		4 9/64	7 15/32	5 3/4	2 3/4	2 1/32	7/8	25/32	6 7/32	1.9370	0.748	1/2
50 1 13/16 1 7/8 1 15/16 2	UCHP210D1 UCHP210-113D1 UCHP210-114D1 UCHP210-115D1 UCHP210-200D1	110	206	159	70	20	22	22	165	51.6	19	M16
		4 21/64	8 1/8	6 1/4	2 3/4	25/32	7/8	7/8	6 1/2	2.0315	0.748	5/8

Note (1) These numbers indicate relubricatable type. If maintenance free type is needed, please order without suffix "D1".

Remarks Please refer to page A21 for size of grease fitting.

Bearing number	Housing number	Mass of unit kg lb
UC209D1	HP209D1	3.5
UC209-110D1	HP209D1	
UC209-111D1	HP209D1	7.7
UC209-112D1	HP209D1	
UC210D1	HP210D1	3.9
UC210-113D1	HP210D1	
UC210-114D1	HP210D1	8.6
UC210-115D1	HP210D1	
UC210-200D1	HP210D1	

Narrow pillow block unit, cast housing Set screw type

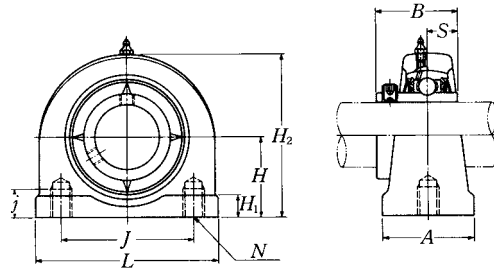

Shaft dia. mm inch	Unit number (1)	Nominal dimensions									
		mm inch									
		H	L	J	A	j	H ₁	H ₂	B	S	N
12 1/2	UCUP201D1	30.2	76	52	38	13	11	62	31	12.7	M10×1.5
	UCUP201-008D1	1 3/16	3	2 1/16	1 1/2	1/2	7/16	2 7/16	1.2205	0.500	
15 9/16 5/8	UCUP202D1	30.2	76	52	38	13	11	62	31	12.7	M10×1.5
	UCUP202-009D1 UCUP202-010D1	1 3/16	3	2 1/16	1 1/2	1/2	7/16	2 7/16	1.2205	0.500	
17 11/16	UCUP203D1	30.2	76	52	38	13	11	62	31	12.7	M10×1.5
	UCUP203-011D1	1 3/16	3	2 1/16	1 1/2	1/2	7/16	2 7/16	1.2205	0.500	
20 3/4	UCUP204D1	30.2	76	52	38	13	11	62	31	12.7	M10×1.5
	UCUP204-012D1	1 3/16	3	2 1/16	1 1/2	1/2	7/16	2 7/16	1.2205	0.500	
25 13/16 7/8 15/16 1	UCUP205D1	36.5	84	56	38	15	12	72	34.1	14.3	M10×1.5
	UCUP205-013D1										
	UCUP205-014D1	1 7/16	3 5/16	2 7/32	1 1/2	19/32	15/32	2 27/32	1.3425	0.563	
	UCUP205-015D1 UCUP205-100D1										
30 1 1/16 1 1/8 1 3/16 1 1/4	UCUP206D1	42.9	94	66	48	18	12	84	38.1	15.9	M14×2
	UCUP206-101D1										
	UCUP206-102D1	1 11/16	3 11/16	2 19/32	1 7/8	23/32	15/32	3 5/16	1.5000	0.629	
	UCUP206-103D1 UCUP206-104D1										
35 1 1/4 1 5/16 1 3/8 1 7/16	UCUP207D1	47.6	110	80	48	20	13	95	42.9	17.5	M14×2
	UCUP207-104D1										
	UCUP207-105D1	1 7/8	4 11/32	3 5/32	1 7/8	25/32	1/2	3 3/4	1.6890	0.689	
	UCUP207-106D1 UCUP207-107D1										
40 1 1/2 1 9/16	UCUP208D1	49.2	116	84	54	20	13	100	49.2	19	M14×2
	UCUP208-108D1 UCUP208-109D1	1 15/16	4 9/16	3 5/16	2 1/8	25/32	1/2	3 15/16	1.9370	0.748	

Note (1) These numbers indicate relubricatable type. If maintenance free type is needed, please order without suffix "D1".

Remarks Please refer to page A21 for size of grease fitting.

Bearing number	Housing number	Mass of unit
		kg lb
UC201D1	UP204D1	0.6
UC201-008D1	UP204D1	1.3
UC202D1	UP204D1	0.6
UC202-009D1	UP204D1	1.3
UC202-010D1	UP204D1	
UC203D1	UP204D1	0.6
UC203-011D1	UP204D1	1.3
UC204D1	UP204D1	0.6
UC204-012D1	UP204D1	1.3
UC205D1	UP205D1	0.7
UC205-013D1	UP205D1	
UC205-014D1	UP205D1	1.5
UC205-015D1	UP205D1	
UC205-100D1	UP205D1	
UC206D1	UP206D1	1.1
UC206-101D1	UP206D1	
UC206-102D1	UP206D1	2.4
UC206-103D1	UP206D1	
UC206-104D1	UP206D1	
UC207D1	UP207D1	1.6
UC207-104D1	UP207D1	
UC207-105D1	UP207D1	3.5
UC207-106D1	UP207D1	
UC207-107D1	UP207D1	
UC208D1	UP208D1	1.8
UC208-108D1	UP208D1	4.0
UC208-109D1	UP208D1	

UCUP2

Narrow pillow block unit, cast housing Set screw type

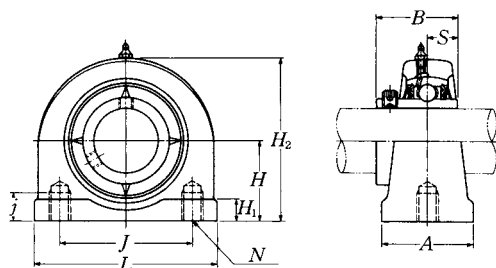

Shaft dia. mm inch	Unit number ⁽¹⁾	Nominal dimensions									
		mm inch									
		<i>H</i>	<i>L</i>	<i>J</i>	<i>A</i>	<i>j</i>	<i>H</i> ₁	<i>H</i> ₂	<i>B</i>	<i>S</i>	<i>N</i>
45	UCUP209D1	54.2	120	90	54	25	13	108	49.2	19	M14×2
$1\frac{5}{8}$	UCUP209-110D1										
$1\frac{11}{16}$	UCUP209-111D1	$2\frac{9}{64}$	$4\frac{23}{32}$	$3\frac{17}{32}$	$2\frac{1}{8}$	$\frac{31}{32}$	$\frac{1}{2}$	$4\frac{1}{4}$	1.9370	0.748	
$1\frac{3}{4}$	UCUP209-112D1										
50	UCUP210D1	57.2	130	94	60	25	14	116	51.6	19	M16×2
$1\frac{13}{16}$	UCUP210-113D1										
$1\frac{7}{8}$	UCUP210-114D1	$2\frac{1}{4}$	$5\frac{1}{8}$	$3\frac{11}{16}$	$2\frac{3}{8}$	$\frac{31}{32}$	$\frac{9}{16}$	$4\frac{9}{16}$	2.0315	0.748	
$1\frac{15}{16}$	UCUP210-115D1										
2	UCUP210-200D1										

Note ⁽¹⁾ These numbers indicate relubricatable type. If maintenance free type is needed, please order without suffix "D1".

Remarks Please refer to page A21 for size of grease fitting.

Bearing number	Housing number	Mass of unit kg lb
UC209D1	UP209D1	2.1
UC209-110D1	UP209D1	
UC209-111D1	UP209D1	4.6
UC209-112D1	UP209D1	
UC210D1	UP210D1	2.6
UC210-113D1	UP210D1	
UC210-114D1	UP210D1	5.7
UC210-115D1	UP210D1	
UC210-200D1	UP210D1	

Pillow block unit, cast housing low center height Set screw type

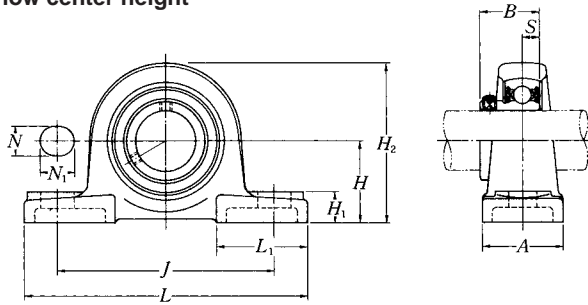

Shaft dia. mm inch	Unit number ⁽¹⁾ (²)(³)	Nominal dimensions											Bolt size mm inch
		mm inch											
		H	L	J	A	N	N ₁	H ₁	H ₂	L ₁	B	S	
12 1/2	ASPL201 ASPL201-008	26.99 1 1/16	121 4 3/4	89 3 1/2	35 1 3/8	11 7/16	14 9/16	13 1/2	54 2 1/8	40 1 9/16	22 0.8661	6 0.236	M10 3/8
15 9/16 5/8	ASPL202 ASPL202-009 ASPL202-010	26.99 1 1/16	121 4 3/4	89 3 1/2	35 1 3/8	11 7/16	14 9/16	13 1/2	54 2 1/8	40 1 9/16	22 0.8661	6 0.236	M10 3/8
17 11/16	ASPL203 ASPL203-011	26.99 1 1/16	121 4 3/4	89 3 1/2	35 1 3/8	11 7/16	14 9/16	13 1/2	54 2 1/8	40 1 9/16	22 0.8661	6 0.236	M10 3/8
20 3/4	ASPL204 ASPL204-012	31.75 1 1/4	127 5	95 3 3/4	38 1 1/2	13 1/2	16 5/8	14 9/16	64 2 17/32	42 1 21/32	25 0.9843	7 0.276	M10 3/8
25 13/16 7/8 15/16	ASPL205 ASPL205-013 ASPL205-014 ASPL205-015 ASPL205-100	33.34 1 5/16	140 5 1/2	105 4 1/8	38 1 1/2	13 1/2	16 5/8	15 19/32	68 2 11/16	42 1 21/32	27 1.0630	7.5 0.295	M10 3/8
30 1 1/16 1 1/8 1 3/16 1 1/4	ASPL206 ASPL206-101 ASPL206-102 ASPL206-103 ASPL206-104	39.69 1 9/16	165 6 1/2	121 4 3/4	48 1 7/8	17 21/32	20 25/32	17 21/32	80 3 5/32	54 2 1/8	29 1.1417	8 0.315	M14 1/2
35 1 1/4 1 5/16 1 3/8 1 7/16	ASPL207 ASPL207-104 ASPL207-105 ASPL207-106 ASPL207-107	46.04 1 13/16	167 6 9/16	127 5	48 1 7/8	17 21/32	20 25/32	18 23/32	91 3 19/32	54 2 1/8	34 1.3386	8.5 0.335	M14 1/2
40 1 1/2 1 9/16	ASP208 ASP208-108 ASP208-109	49.2 1 15/16	184 7 1/4	137 5 13/32	54 2 1/8	17 21/32	20 25/32	18 23/32	98 3 27/32	52 2 1/16	38 1.4961	9 0.354	M14 1/2

Notes (1) ASPL201 to ASPL205 has solid bases.
(2) If relubricatable type is needed, please order with suffix "D1".
(3) ASPL208 has the same dimension an ASP208.

Bearing number ⁽²⁾	Housing number ⁽²⁾	Mass of unit kg lb
AS201 AS201-008	PL201 PL201	0.5 1.1
AS202 AS202-009 AS202-010	PL201 PL201 PL201	0.5 1.1
AS203 AS203-011	PL201 PL201	0.5 1.1
AS204 AS204-012	PL204 PL204	0.7 1.5
AS205 AS205-013 AS205-014 AS205-015 AS205-100	PL205 PL205 PL205 PL205	0.8 1.8
AS206 AS206-101 AS206-102 AS206-103 AS206-104	PL206 PL206 PL206 PL206	1.2 2.6
AS207 AS207-104 AS207-105 AS207-106 AS207-107	PL207 PL207 PL207 PL207	1.5 3.3
AS208 AS208-108 AS208-109	P208 P208 P208	1.8 4.0

Pillow block unit, cast housing low center height Set screw type

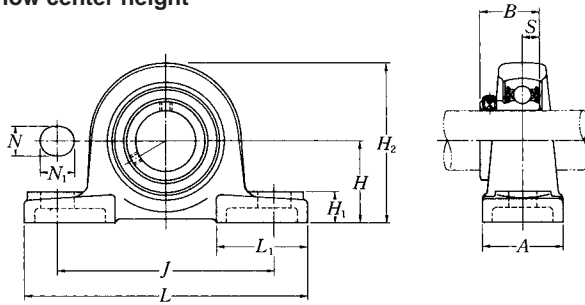

Shaft dia.	Unit number (1)	Nominal dimensions											Bolt size
		mm inch											
mm inch		H	L	J	A	N	N ₁	H ₁	H ₂	L ₁	B	S	mm inch
45	ASPL209	52.39	190	146	54	17	20	20	104	60	40	9.5	M14
1 5/8	ASPL209-110												
1 11/16	ASPL209-111	2 3/16	7 15/32	5 3/4	2 1/8	2 1/32	25/32	25/32	4 3/32	2 3/8	1.578	0.374	1/2
1 3/4	ASPL209-112												
50	ASPL210	55.56	206	159	60	20	23	21	112	65	42	10	M16
1 13/16	ASPL210-113												
1 7/8	ASPL210-114	2 3/16	8 1/8	6 1/4	2 3/8	25/32	29/32	13/16	4 13/32	2 9/16	1.635	0.394	5/8
1 15/16	ASPL210-115												
2	ASPL210-200												

Note (1) If relubricatable type is needed, please order with suffix "D1".

Bearing number (1)	Housing number (1)	Mass of unit
		kg lb
AS209	PL209	2.0
AS209-110	PL209	
AS209-111	PL209	4.4
AS209-112	PL209	
AS210	PL210	2.6
AS210-113	PL210	
AS210-114	PL210	5.7
AS210-115	PL210	
AS210-200	PL210	

Pillow block unit, pressed steel housing Set screw type

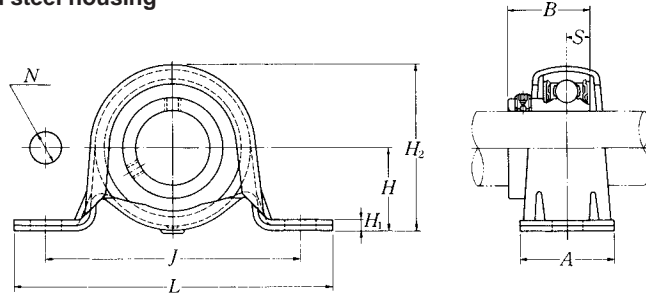

Shaft dia. mm inch	Unit number	Nominal dimensions										Bolt size mm inch
		mm inch										
		H	L	J	A	N	H ₁	H ₂	B	S		
12 1/2	ASPP201 ASPP201-008	22.2 7/8	86 3 3/8	68 2 11/16	25 31/32	9.5 3/8	3.2 0.126	43.8 1 23/32	22 0.8661	6 0.236	M8 5/16	
15 9/16 5/8	ASPP202 ASPP202-009 ASPP202-010	22.2 7/8	86 3 3/8	68 2 11/16	25 31/32	9.5 3/8	3.2 0.126	43.8 1 23/32	22 0.8661	6 0.236	M8 5/16	
17 11/16	ASPP203 ASPP203-011	22.2 7/8	86 3 3/8	68 2 11/16	25 31/32	9.5 3/8	3.2 0.126	43.8 1 23/32	22 0.8661	6 0.236	M8 5/16	
20 3/4	ASPP204 ASPP204-012	25.4 1	98 3 27/32	76 3	32 1 1/4	9.5 3/8	3.2 0.126	50.5 2	25 0.9843	7 0.276	M8 5/16	
25 13/16 7/8 15/16 1	ASPP205 ASPP205-013 ASPP205-014 ASPP205-015 ASPP205-100	28.6 1 1/8	108 4 1/4	86 3 3/8	32 1 1/4	11.5 29/64	4 0.157	56.6 2 7/32	27 1.0630	7.5 0.295	M10 3/8	
30 1 1/16 1 1/8 1 3/16 1 1/4	ASPP206 ASPP206-101 ASPP206-102 ASPP206-103 ASPP206-104	33.3 1 5/16	117 4 19/32	95 3 3/4	38 1 1/2	11.5 29/64	4 0.157	66.3 2 5/8	29 1.1417	8 0.315	M10 3/8	
35 1 1/4 1 5/16 1 3/8 1 1/2	ASPP207 ASPP207-104 ASPP207-105 ASPP207-106 ASPP207-107	39.7 1 9/16	129 5 3/32	106 4 3/16	42 1 21/32	11.5 29/64	4.6 0.181	78 3 1/16	34 1.3386	8.5 0.335	M10 3/8	

Note (1) The permissible load only applies in applications where the load is stable and the speed is 2400 min⁻¹ or less. The mounting surface should be flat.

Max. load (1)		Bearing number	Housing number	Mass of unit
N lbf				
radial	axial			kg lb
2 000 440	800 160	AS201 AS201-008	PP203 PP203	0.2 0.4
2 000 440	800 160	AS202 AS202-009 AS202-010	PP203 PP203 PP203	0.2 0.4
2 000 440	800 160	AS203 AS203-011	PP203 PP203	0.1 0.2
2 500 550	1 000 200	AS204 AS204-012	PP204 PP204	0.2 0.4
3 500	1 400	AS205 AS205-013 AS205-014 AS205-015 AS205-100	PP205 PP205 PP205 PP205	0.3 0.7
4 000	1 600	AS206 AS206-101 AS206-102 AS206-103 AS206-104	PP206 PP206 PP206 PP206	0.4 0.9
4 500	1 800	AS207 AS207-104 AS207-105 AS207-106 AS207-107	PP207 PP207 PP207 PP207	0.6 1.3

Pillow block unit, pressed steel housing with rubber ring Set screw type

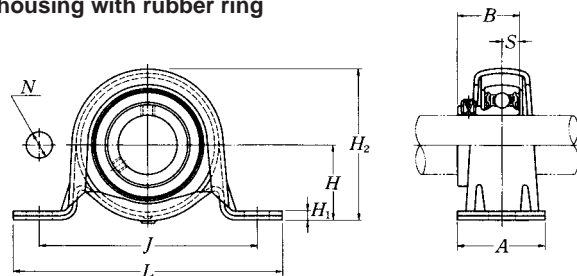

Shaft dia. mm inch	Unit number	Nominal dimensions									Bolt size mm inch
		mm inch									
		H	L	J	A	N	H ₁	H ₂	B	S	
12 1/2	ASRPP201 ASRPP201-008	25.4 1	98 3 ²⁷ / ₃₂	76 3	32 1 ¹ / ₄	9.5 3/8	3.2 0.126	50.5 2	22 0.8661	6 0.236	M8 5/16
15 9/16 5/8	ASRPP202 ASRPP202-009 ASRPP202-010	25.4 1	98 3 ²⁷ / ₃₂	76 3	32 1 ¹ / ₄	9.5 3/8	3.2 0.126	50.5 2	22 0.8661	6 0.236	M8 5/16
17 11/16	ASRPP203 ASRPP203-011	25.4 1	98 3 ²⁷ / ₃₂	76 3	32 1 ¹ / ₄	9.5 3/8	3.2 0.126	50.5 2	22 0.8661	6 0.236	M8 5/16
20 3/4	ASRPP204 ASRPP204-012	28.6 1 ¹ / ₈	108 4 ¹ / ₄	86 3 ³ / ₈	32 1 ¹ / ₄	11.5 29/64	4 0.157	56.6 2 ⁷ / ₃₂	25 0.9843	7 0.276	M10 3/8
25 13/16 7/8 15/16 1	ASRPP205 ASRPP205-013 ASRPP205-014 ASRPP205-015 ASRPP205-100	33.3 1 ⁵ / ₁₆	117 4 ¹⁹ / ₃₂	95 3 ³ / ₄	38 1 ¹ / ₂	11.5 29/64	4 0.157	66.3 2 ⁵ / ₈	27 1.0630	7.5 0.295	M10 3/8
30 1 ¹ / ₁₆ 1 ¹ / ₈ 1 ³ / ₁₆ 1 ¹ / ₄	ASRPP206 ASRPP206-101 ASRPP206-102 ASRPP206-103 ASRPP206-104	39.7 1 ⁹ / ₁₆	129 5 ³ / ₃₂	106 4 ³ / ₁₆	42 1 ²¹ / ₃₂	11.5 29/64	4.6 0.181	78 3 ¹ / ₁₆	29 1.1417	8 0.315	M10 3/8

Note (1) The permissible load only applies in applications where the load is stable and the speed is 2400 min⁻¹ or less. The mounting surface should be flat.

Remarks When an anti-vibration rubber ring is used, the self alignment capability will be reduce.

Max. load (1)		Bearing number	Housing number		Mass of unit kg lb
N lbf			rubber ring	steel	
radial	axial				
1 000 220	200 40	AS201 AS201-008	R201 R201	PP204 PP204	0.2 0.4
1 000 220	200 40	AS202 AS202-009 AS202-010	R201 R201 R201	PP204 PP204 PP204	0.2 0.4
1 000 220	200 40	AS203 AS203-011	R201 R201	PP204 PP204	0.2 0.4
1 150 250	200 40	AS204 AS204-012	R204 R204	PP205 PP205	0.3 0.7
1 300	200	AS205 AS205-013 AS205-014 AS205-015 AS205-100	R205 R205 R205 R205	PP206 PP206 PP206 PP206	0.4 0.9
1 500	200	AS206 AS206-101 AS206-102 AS206-103 AS206-104	R206 R206 R206 R206	PP207 PP207 PP207 PP207	0.5 1.1

Square flanged unit, cast housing Set screw type

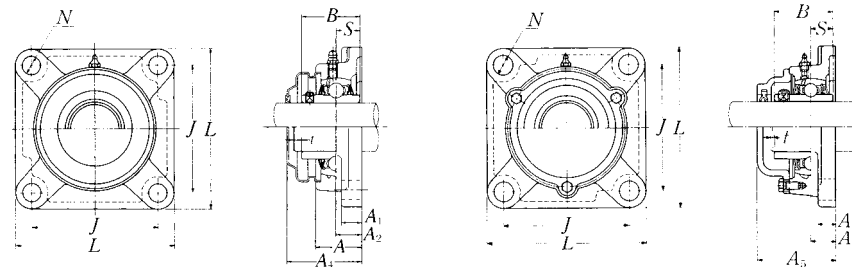
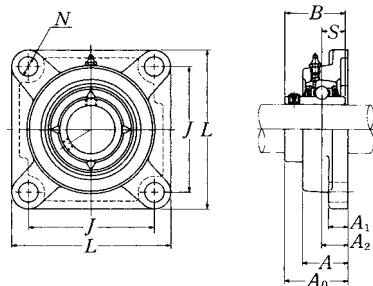

Pressed steel dust cover type
Open end **Z-UCF...D1**
Closed end **ZM-UCF...D1**

Cast dust cover type
Open end **C-UCF...D1**
Closed end **CM-UCF...D1**

Shaft dia. mm inch	Unit number (1)	Nominal dimensions										Bolt size mm inch	Bearing number
		mm inch											
		L	J	A ₂	A ₁	A	N	A ₀	B	S			
12 1/2	UCF201D1 UCF201-008D1	86 3 3/8	64 2 33/64	15 19/32	11 7/16	25.5 1	12 15/32	33.3 1 5/16	31 1.2205	12.7 0.500	M10 3/8	UC201D1 UC201-008D1	
15 9/16 5/8	UCF202D1 UCF202-009D1 UCF202-010D1	86 3 3/8	64 2 33/64	15 19/32	11 7/16	25.5 1	12 15/32	33.3 1 5/16	31 1.2205	12.7 0.500	M10 3/8	UC202D1 UC202-009D1 UC202-010D1	
17 11/16	UCF203D1 UCF203-011D1	86 3 3/8	64 2 33/64	15 19/32	11 7/16	25.5 1	12 15/32	33.3 1 5/16	31 1.2205	12.7 0.500	M10 3/8	UC203D1 UC203-011D1	
20 3/4	UCF204D1 UCF204-012D1	86 3 3/8	64 2 33/64	15 19/32	11 7/16	25.5 1	12 15/32	33.3 1 5/16	31 1.2205	12.7 0.500	M10 3/8	UC204D1 UC204-012D1	
25 13/16 7/8 15/16 1	UCF205D1 UCF205-013D1 UCF205-014D1 UCF205-015D1 UCF205-100D1	95 3 3/4	70 2 3/4	16 5/8	13 1/2	27 1 1/16	12 15/32	35.8 1 13/32	34.1 1.3425	14.3 0.563	M10 3/8	UC205D1 UC205-013D1 UC205-014D1 UC205-015D1 UC205-100D1	
30 1 1/16 1 1/8 1 3/16 1 1/4	UCF206D1 UCF206-101D1 UCF206-102D1 UCF206-103D1 UCF206-104D1	108 4 1/4	83 3 17/64	18 45/64	13 1/2	31 1 7/32	12 15/32	40.2 1 37/64	38.1 1.5000	15.9 0.626	M10 3/8	UC206D1 UC206-101D1 UC206-102D1 UC206-103D1 UC206-104D1	
35 1 1/4 1 5/16 1 3/8 1 1/2	UCF207D1 UCF207-104D1 UCF207-105D1 UCF207-106D1 UCF207-107D1	117 4 19/32	92 3 5/8	19 3/4	15 19/32	34 1 11/32	14 35/64	44.4 1 3/4	42.9 1.6890	17.5 0.689	M12 7/16	UC207D1 UC207-104D1 UC207-105D1 UC207-106D1 UC207-107D1	
40 1 1/2 1 5/16	UCF208D1 UCF208-108D1 UCF208-109D1	130 5 1/8	102 4 1/64	21 53/64	15 19/32	36 1 13/32	16 5/8	51.2 2 1/64	49.2 1.9370	19 0.748	M14 1/2	UC208D1 UC208-108D1 UC208-109D1	
45 1 5/8 1 11/16 1 3/4	UCF209D1 UCF209-110D1 UCF209-111D1 UCF209-112D1	137 5 13/32	105 4 9/64	22 55/64	16 5/8	38 1 1/2	16 5/8	52.2 2 1/16	49.2 1.9370	19 0.748	M14 1/2	UC209D1 UC209-110D1 UC209-111D1 UC209-112D1	

Note (1) These numbers indicate relubricatable type. If maintenance free type is needed, please order without suffix "D1".

Remarks Please refer to page A21 for size of grease fitting.

Housing number	Unit number (1) pressed steel dust cover type	Unit number (1) cast dust cover type	Nominal dimensions			Mass of unit		
			t max.	A ₄	A ₅	UCF	Z(ZM)	C(CM)
			mm	inch	mm	inch	kg	lb
F204D1	Z(ZM)-UCF201D1	C(CM)-UCF201D1	2	38	46	0.6	0.6	0.8
F204D1	Z(ZM)-UCF201-008D1	C(CM)-UCF201-008D1	5/64	1 1/2	1 13/16	1.3	1.3	1.8
F204D1	Z(ZM)-UCF202D1	C(CM)-UCF202D1	2	38	46	0.6	0.6	0.8
F204D1	Z(ZM)-UCF202-009D1	C(CM)-UCF202-009D1	5/64	1 1/2	1 13/16	1.3	1.3	1.8
F204D1	Z(ZM)-UCF202-010D1	C(CM)-UCF202-010D1						
F204D1	Z(ZM)-UCF203D1	C(CM)-UCF203D1	2	38	46	0.6	0.6	0.8
F204D1	Z(ZM)-UCF203-011D1	C(CM)-UCF203-011D1	5/64	1 1/2	1 13/16	1.3	1.3	1.8
F204D1	Z(ZM)-UCF204D1	C(CM)-UCF204D1	2	38	46	0.6	0.6	0.7
F204D1	Z(ZM)-UCF204-012D1	C(CM)-UCF204-012D1	5/64	1 1/2	1 13/16	1.3	1.3	1.5
F205D1	Z(ZM)-UCF205D1	C(CM)-UCF205D1	2	40	51	0.8	0.8	0.9
F205D1	Z(ZM)-UCF205-013D1	C(CM)-UCF205-013D1						
F205D1	Z(ZM)-UCF205-014D1	C(CM)-UCF205-014D1	5/64	1 19/32	2	1.8	1.8	2.0
F205D1	Z(ZM)-UCF205-015D1	C(CM)-UCF205-015D1						
F205D1	Z(ZM)-UCF205-100D1	C(CM)-UCF205-100D1						
F206D1	Z(ZM)-UCF206D1	C(CM)-UCF206D1	2	45	56	1.1	1.1	1.3
F206D1	Z(ZM)-UCF206-101D1	C(CM)-UCF206-101D1						
F206D1	Z(ZM)-UCF206-102D1	C(CM)-UCF206-102D1	5/64	1 3/4	2 7/32	2.4	2.4	2.9
F206D1	Z(ZM)-UCF206-103D1	C(CM)-UCF206-103D1						
F206D1	—	C(CM)-UCF206-104D1						
F207D1	Z(ZM)-UCF207D1	C(CM)-UCF207D1	3	49	59	1.5	1.5	1.8
F207D1	Z(ZM)-UCF207-104D1	C(CM)-UCF207-104D1						
F207D1	Z(ZM)-UCF207-105D1	C(CM)-UCF207-105D1	1/8	1 15/16	2 5/16	3.3	3.3	4.0
F207D1	Z(ZM)-UCF207-106D1	C(CM)-UCF207-106D1						
F207D1	—	C(CM)-UCF207-107D1						
F208D1	Z(ZM)-UCF208D1	C(CM)-UCF208D1	3	56	66	1.7	1.8	2.2
F208D1	Z(ZM)-UCF208-108D1	C(CM)-UCF208-108D1	1/8	2 3/16	2 19/32	3.7	4.0	4.9
F208D1	Z(ZM)-UCF208-109D1	C(CM)-UCF208-109D1						
F209D1	Z(ZM)-UCF209D1	C(CM)-UCF209D1	3	57	70	2.1	2.2	2.6
F209D1	Z(ZM)-UCF209-110D1	C(CM)-UCF209-110D1						
F209D1	Z(ZM)-UCF209-111D1	C(CM)-UCF209-111D1	1/8	2 1/4	2 3/4	4.6	4.9	5.7
F209D1	Z(ZM)-UCF209-112D1	C(CM)-UCF209-112D1						

Square flanged unit, cast housing Set screw type

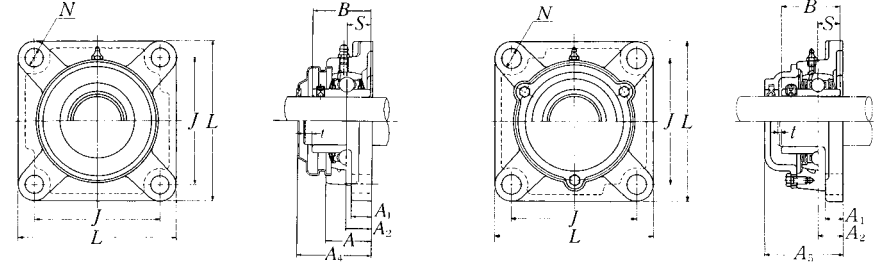
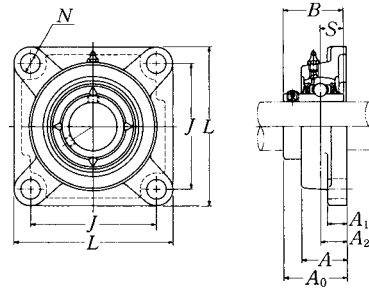

Pressed steel dust cover type
Open end **Z-UCF...D1**
Closed end **ZM-UCF...D1**

Cast dust cover type
Open end **C-UCF...D1**
Closed end **CM-UCF...D1**

Shaft dia. mm inch	Unit number (1)	Nominal dimensions									Bolt size mm inch	Bearing number
		L	J	A ₂	A ₁	A	N	A ₀	B	S		
50 1 3/16 1 7/8 1 15/16 2	UCF210D1 UCF210-113D1 UCF210-114D1 UCF210-115D1 UCF210-200D1	143	111	22	16	40	16	54.6	51.6	19	M14	UC210D1 UC210-113D1 UC210-114D1 UC210-115D1 UC210-200D1
		5 5/8	4 3/8	55/64	5/8	1 9/16	5/8	2 5/32	2.0315	0.748	1/2	
55 2 2 1/16 2 1/8 2 3/16	UCF211D1 UCF211-200D1 UCF211-201D1 UCF211-202D1 UCF211-203D1	162	130	25	18	43	19	58.4	55.6	22.2	M16	UC211D1 UC211-200D1 UC211-201D1 UC211-202D1 UC211-203D1
		6 3/8	5 1/8	63/64	23/32	1 11/16	3/4	2 19/64	2.1890	0.874	5/8	
60 2 1/4 2 1/16 2 3/8 2 7/16	UCF212D1 UCF212-204D1 UCF212-205D1 UCF212-206D1 UCF212-207D1	175	143	29	18	48	19	68.7	65.1	25.4	M16	UC212D1 UC212-204D1 UC212-205D1 UC212-206D1 UC212-207D1
		6 7/8	5 5/8	1 9/64	23/32	1 7/8	3/4	2 45/64	2.5630	1.000	5/8	
65 2 1/2 2 9/16	UCF213D1 UCF213-208D1 UCF213-209D1	187	149	30	22	50	19	69.7	65.1	25.4	M16	UC213D1 UC213-208D1 UC213-209D1
		7 3/8	5 55/64	1 3/16	7/8	1 31/32	3/4	2 3/4	2.5630	1.000	5/8	
70 2 5/8 2 11/16 2 3/4	UCF214D1 UCF214-210D1 UCF214-211D1 UCF214-212D1	193	152	31	22	54	19	75.4	74.6	30.2	M16	UC214D1 UC214-210D1 UC214-211D1 UC214-212D1
		7 19/32	5 63/64	1 7/32	7/8	2 1/8	3/4	2 31/32	2.9370	1.189	5/8	
75 2 3/16 2 7/8 2 15/16 3	UCF215D1 UCF215-213D1 UCF215-214D1 UCF215-215D1 UCF215-300D1	200	159	34	22	56	19	78.5	77.8	33.3	M16	UC215D1 UC215-213D1 UC215-214D1 UC215-215D1 UC215-300D1
		7 7/8	6 17/64	1 11/32	7/8	2 3/32	3/4	3 3/32	3.0630	1.311	5/8	
80 3 1/16 3 1/8 3 3/16	UCF216D1 UCF216-301D1 UCF216-302D1 UCF216-303D1	208	165	34	22	58	23	83.3	82.6	33.3	M20	UC216D1 UC216-301D1 UC216-302D1 UC216-303D1
		8 3/16	6 1/2	1 11/32	7/8	2 9/32	29/32	3 3/32	3.2520	1.311	3/4	

Housing number	Unit number (1) pressed steel dust cover type	Unit number (1) cast dust cover type	Nominal dimensions			Mass of unit		
			t max.	A ₄	A ₅	UCF	Z(ZM)	C(CM)
F210D1	Z(ZM)-UCF210D1	C(CM)-UCF210D1	3	60	72	2.5	2.5	3.0
F210D1	Z(ZM)-UCF210-113D1	C(CM)-UCF210-113D1						
F210D1	Z(ZM)-UCF210-114D1	C(CM)-UCF210-114D1						
F210D1	Z(ZM)-UCF210-115D1	C(CM)-UCF210-115D1	1/8	2 3/8	2 27/32	5.5	5.5	6.6
F210D1	—	C(CM)-UCF210-200D1						
F211D1	Z(ZM)-UCF211D1	C(CM)-UCF211D1	4	64	75	3.3	3.4	4.0
F211D1	Z(ZM)-UCF211-200D1	C(CM)-UCF211-200D1						
F211D1	Z(ZM)-UCF211-201D1	C(CM)-UCF211-201D1						
F211D1	Z(ZM)-UCF211-202D1	C(CM)-UCF211-202D1	5/32	2 1/2	2 15/16	7.3	7.5	8.8
F211D1	Z(ZM)-UCF211-203D1	C(CM)-UCF211-203D1						
F212D1	Z(ZM)-UCF212D1	C(CM)-UCF212D1	4	74	86	3.9	4.1	4.8
F212D1	Z(ZM)-UCF212-204D1	C(CM)-UCF212-204D1						
F212D1	Z(ZM)-UCF212-205D1	C(CM)-UCF212-205D1						
F212D1	Z(ZM)-UCF212-206D1	C(CM)-UCF212-206D1	5/32	2 29/32	3 3/8	8.6	9.0	11
F212D1	—	C(CM)-UCF212-207D1						
F213D1	Z(ZM)-UCF213D1	C(CM)-UCF213D1	4	76	90	5.5	5.6	6.4
F213D1	Z(ZM)-UCF213-208D1	C(CM)-UCF213-208D1	5/32	3	3 17/32	12	12	14
F213D1	Z(ZM)-UCF213-209D1	C(CM)-UCF213-209D1						
F214D1	—	C(CM)-UCF214D1	4	—	98	6.3	—	7.4
F214D1	—	C(CM)-UCF214-210D1						
F214D1	—	C(CM)-UCF214-211D1	5/32	—	3 27/32	14	—	16
F214D1	—	C(CM)-UCF214-212D1						
F215D1	—	C(CM)-UCF215D1	4	—	102	6.6	—	7.9
F215D1	—	C(CM)-UCF215-213D1						
F215D1	—	C(CM)-UCF215-214D1						
F215D1	—	C(CM)-UCF215-215D1	5/32	—	4 1/32	15	—	17
F215D1	—	C(CM)-UCF215-300D1						
F216D1	—	C(CM)-UCF216D1	4	—	106	7.9	—	9.3
F216D1	—	C(CM)-UCF216-301D1						
F216D1	—	C(CM)-UCF216-302D1	5/32	—	4 3/16	17	—	21
F216D1	—	C(CM)-UCF216-303D1						

Note (1) These numbers indicate relubricatable type. If maintenance free type is needed, please order without suffix "D1".

Remarks Please refer to page A21 for size of grease fitting.

Square flanged unit, cast housing Set screw type

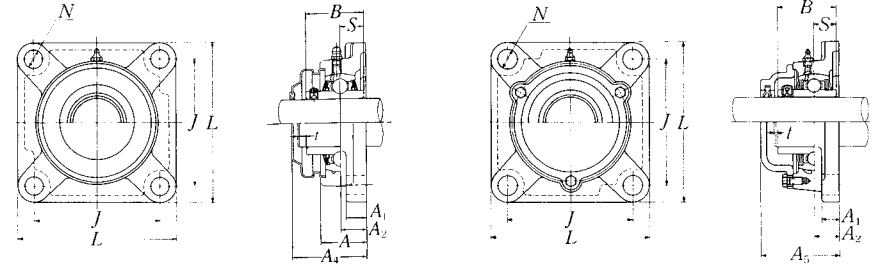
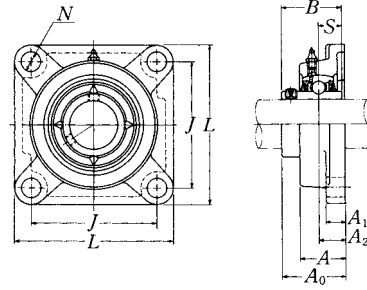

Pressed steel dust cover type
Open end **Z-UCF...D1**
Closed end **ZM-UCF...D1**

Cast dust cover type
Open end **C-UCF...D1**
Closed end **CM-UCF...D1**

Shaft dia. mm inch	Unit number (1)	Nominal dimensions										Bolt size mm inch	Bearing number
		mm inch											
		L	J	A ₂	A ₁	A	N	A ₀	B	S			
85 3 1/4	UCF217D1	220	175	36	24	63	23	87.6	85.7	34.1	M20	UC217D1	
3 1/8	UCF217-304D1											UC217-304D1	
3 7/16	UCF217-305D1	8 21/32	6 57/64	1 27/64	15/16	2 15/32	29/32	3 29/64	3.3740	1.343	3/4	UC217-305D1	
3 7/16	UCF217-307D1											UC217-307D1	
90 3 1/2	UCF218D1	235	187	40	24	68	23	96.3	96	39.7	M20	UC218D1	
	UCF218-308D1	9 1/4	7 23/64	1 37/64	15/16	2 11/16	29/32	3 51/64	3.7795	1.563	3/4	UC218-308D1	

Housing number	Unit number (1) pressed steel dust cover type	Unit number (1) cast dust cover type	Nominal dimensions			Mass of unit		
			t max.	A ₄	A ₅	UCF	Z(ZM)	C(CM)
F217D1	—	C(CM)-UCF217D1	5	—	114	9.8	—	12
F217D1	—	C(CM)-UCF217-304D1						
F217D1	—	C(CM)-UCF217-305D1	13/64	—	4 1/2	22	—	26
F217D1	—	C(CM)-UCF217-307D1						
F218D1	—	C(CM)-UCF218D1	5	—	122	12	—	13
F218D1	—	C(CM)-UCF218-308D1	13/64	—	4 13/16	26	—	29

Note (1) These numbers indicate relubricatable type. If maintenance free type is needed, please order without suffix "D1".
Remarks Please refer to page A21 for size of grease fitting.

Square flanged unit, cast housing Set screw type

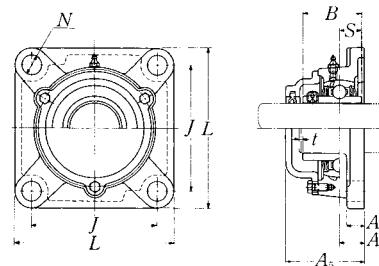
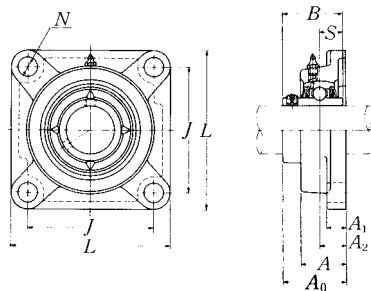

Cast dust cover type
Open end **C-UCF...D1**
Closed end **CM-UCF...D1**

Shaft dia. mm inch	Unit number ⁽¹⁾	Nominal dimensions									Bolt size mm inch
		mm inch									
		L	J	A ₂	A ₁	A	N	A ₀	B	S	
25 1 13/16 7/8 15/16 1	UCF305D1 UCF305-013D1 UCF305-014D1 UCF305-015D1 UCF305-100D1	110 4 11/32	80 3 5/32	16 5/8	13 1/2	29 1 5/32	16 5/8	39 1 17/32	38 1.4961	15 0.591	M14 1/2
30 1 1/16 1 1/8 1 3/16	UCF306D1 UCF306-101D1 UCF306-102D1 UCF306-103D1	125 4 29/32	95 3 47/64	18 45/64	15 19/32	32 1 1/4	16 5/8	44 1 47/64	43 1.6929	17 0.669	M14 1/2
35 1 1/4 1 5/16 1 3/8 1 7/16	UCF307D1 UCF307-104D1 UCF307-105D1 UCF307-106D1 UCF307-107D1	135 5 5/16	100 3 15/16	20 25/32	16 5/8	36 1 13/32	19 3/4	49 1 59/64	48 1.8898	19 0.748	M16 5/8
40 1 1/2 1 7/16	UCF308D1 UCF308-108D1 UCF308-109D1	150 5 29/32	112 4 19/32	23 29/32	17 21/32	40 1 9/16	19 3/4	56 2 19/64	52 2.0472	19 0.748	M16 5/8
45 1 5/8 1 11/16 1 3/4	UCF309D1 UCF309-110D1 UCF309-111D1 UCF309-112D1	160 6 5/16	125 4 59/64	25 63/64	18 23/32	44 1 23/32	19 3/4	60 2 23/64	57 2.2441	22 0.866	M16 5/8
50 1 13/16 1 7/8 1 15/16	UCF310D1 UCF310-113D1 UCF310-114D1 UCF310-115D1	175 6 7/8	132 5 19/64	28 1 7/64	19 3/4	48 1 7/8	23 29/32	67 2 41/64	61 2.4016	22 0.866	M20 3/4
55 2 2 1/16 2 1/8 2 3/16	UCF311D1 UCF311-200D1 UCF311-201D1 UCF311-202D1 UCF311-203D1	185 7 9/32	140 5 39/64	30 1 3/16	20 25/32	52 2 1/16	23 29/32	71 2 51/64	66 2.5984	25 0.984	M20 3/4

Note ⁽¹⁾ These numbers indicate relubricatable type. If maintenance free type is needed, please order without suffix "D1".
Remarks Please refer to page A21 for size of grease fitting.

Bearing number	Housing number	Unit number ⁽¹⁾ cast dust cover type	Nominal dimensions		Mass of unit	
			t mm max.	A ₃ inch	UCF	C(CM) lb
UC305D1 UC305-013D1 UC305-014D1 UC305-015D1 UC305-100D1	F305D1 F305D1 F305D1 F305D1 F305D1	C(CM)-UCF305D1 C(CM)-UCF305-013D1 C(CM)-UCF305-014D1 C(CM)-UCF305-015D1 C(CM)-UCF305-100D1	2 5/64	56 2 7/32	1.1 2.4	1.4 3.1
UC306D1 UC306-101D1 UC306-102D1 UC306-103D1	F306D1 F306D1 F306D1 F306D1	C(CM)-UCF306D1 C(CM)-UCF306-101D1 C(CM)-UCF306-102D1 C(CM)-UCF306-103D1	2 5/64	60 2 3/8	1.6 3.5	2.1 4.6
UC307D1 UC307-104D1 UC307-105D1 UC307-106D1 UC307-107D1	F307D1 F307D1 F307D1 F307D1 F307D1	C(CM)-UCF307D1 C(CM)-UCF307-104D1 C(CM)-UCF307-105D1 C(CM)-UCF307-106D1 C(CM)-UCF307-107D1	3 1/8	68 2 11/16	2.1 4.6	2.6 5.7
UC308D1 UC308-108D1 UC308-109D1	F308D1 F308D1 F308D1	C(CM)-UCF308D1 C(CM)-UCF308-108D1 C(CM)-UCF308-109D1	3 1/8	76 3	2.7 6.0	3.4 7.5
UC309D1 UC309-110D1 UC309-111D1 UC309-112D1	F309D1 F309D1 F309D1 F309D1	C(CM)-UCF309D1 C(CM)-UCF309-110D1 C(CM)-UCF309-111D1 C(CM)-UCF309-112D1	3 1/8	80 3 5/32	3.4 7.5	4.3 9.5
UC310D1 UC310-113D1 UC310-114D1 UC310-115D1	F310D1 F310D1 F310D1 F310D1	C(CM)-UCF310D1 C(CM)-UCF310-113D1 C(CM)-UCF310-114D1 C(CM)-UCF310-115D1	3 1/8	88 3 15/32	4.5 9.9	5.8 13
UC311D1 UC311-200D1 UC311-201D1 UC311-202D1 UC311-203D1	F311D1 F311D1 F311D1 F311D1 F311D1	C(CM)-UCF311D1 C(CM)-UCF311-200D1 C(CM)-UCF311-201D1 C(CM)-UCF311-202D1 C(CM)-UCF311-203D1	4 5/32	92 3 5/8	5.3 12	6.7 15

Square flanged unit, cast housing Set screw type

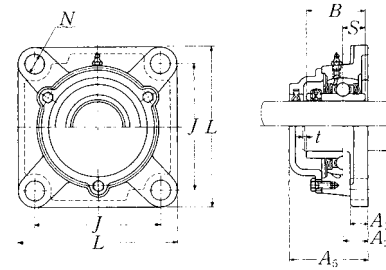
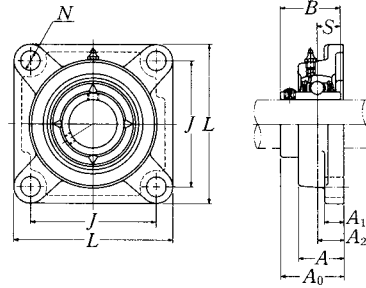

Cast dust cover type
Open end **C-UCF...D1**
Closed end **CM-UCF...D1**

Shaft dia. mm inch	Unit number (1)	Nominal dimensions									Bolt size mm inch
		mm inch									
		L	J	A ₂	A ₁	A	N	A ₀	B	S	
60 2 1/4 2 5/16 2 3/8 2 7/16	UCF312D1 UCF312-204D1 UCF312-205D1 UCF312-206D1 UCF312-207D1	195	150	33	22	56	23	78	71	26	M20
		7 11/16	5 29/32	1 19/64	7/8	2 7/32	29/32	3 5/64	2.7953	1.024	3/4
65 2 1/2 2 9/16	UCF313D1 UCF313-208D1 UCF313-209D1	208	166	33	22	58	23	78	75	30	M20
		8 3/16	6 17/32	1 19/64	7/8	2 9/32	29/32	3 5/64	2.9528	1.181	3/4
70 2 5/8 2 11/16 2 3/4	UCF314D1 UCF314-210D1 UCF314-211D1 UCF314-212D1	226	178	36	25	61	25	81	78	33	M22
		8 29/32	6 1/4	1 27/64	31/32	2 13/32	63/64	3 3/16	3.0709	1.299	7/8
75 2 13/16 2 7/8 2 15/16 3	UCF315D1 UCF315-213D1 UCF315-214D1 UCF315-215D1 UCF315-300D1	236	184	39	25	66	25	89	82	32	M22
		9 9/32	7 1/4	1 17/32	31/32	2 19/32	63/64	3 1/2	3.2283	1.260	7/8
80 3 1/16 3 1/8 3 1/16	UCF316D1 UCF316-301D1 UCF316-302D1 UCF316-303D1	250	196	38	27	68	31	90	86	34	M27
		9 27/32	7 23/32	1 1/2	1 1/16	2 1/16	1 7/32	3 35/64	3.3858	1.339	1
85 3 1/4 3 5/16 3 7/16	UCF317D1 UCF317-304D1 UCF317-305D1 UCF317-307D1	260	204	44	27	74	31	100	96	40	M27
		10 1/4	8 1/32	1 47/64	1 1/16	2 29/32	1 7/32	3 15/16	3.7795	1.575	1
90 3 7/16 3 1/2	UCF318D1 UCF318-307D1 UCF318-308D1	280	216	44	30	76	35	100	96	40	M30
		11 1/32	8 1/2	1 47/64	1 3/16	3	1 3/8	3 15/16	3.7795	1.575	1 1/8

Note (1) These numbers indicate relubricatable type. If maintenance free type is needed, please order without suffix "D1".

Remarks Please refer to page A21 for size of grease fitting.

Bearing number	Housing number	Unit number (1) cast dust cover type	Nominal dimensions		Mass of unit	
			t max.	A ₅	UCF	C(CM)
			mm inch		kg	lb
UC312D1	F312D1	C(CM)-UCF312D1	4	100	6.3	7.8
UC312-204D1	F312D1	C(CM)-UCF312-204D1				
UC312-205D1	F312D1	C(CM)-UCF312-205D1	5/32	3 15/16	14	17
UC312-206D1	F312D1	C(CM)-UCF312-206D1				
UC312-207D1	F312D1	C(CM)-UCF312-207D1				
UC313D1	F313D1	C(CM)-UCF313D1	4	103	8.0	9.7
UC313-208D1	F313D1	C(CM)-UCF313-208D1	5/32	4 1/16	18	21
UC313-209D1	F313D1	C(CM)-UCF313-209D1				
UC314D1	F314D1	C(CM)-UCF314D1	4	106	9.4	11
UC314-210D1	F314D1	C(CM)-UCF314-210D1				
UC314-211D1	F314D1	C(CM)-UCF314-211D1	5/32	4 3/16	21	24
UC314-212D1	F314D1	C(CM)-UCF314-212D1				
UC315D1	F315D1	C(CM)-UCF315D1	4	114	11	13
UC315-213D1	F315D1	C(CM)-UCF315-213D1				
UC315-214D1	F315D1	C(CM)-UCF315-214D1	5/32	4 1/2	24	29
UC315-215D1	F315D1	C(CM)-UCF315-215D1				
UC315-300D1	F315D1	C(CM)-UCF315-300D1				
UC316D1	F316D1	C(CM)-UCF316D1	4	116	14	16
UC316-301D1	F316D1	C(CM)-UCF316-301D1				
UC316-302D1	F316D1	C(CM)-UCF316-302D1	5/32	4 9/16	31	35
UC316-303D1	F316D1	C(CM)-UCF316-303D1				
UC317D1	F317D1	C(CM)-UCF317D1	5	129	15	19
UC317-304D1	F317D1	C(CM)-UCF317-304D1				
UC317-305D1	F317D1	C(CM)-UCF317-305D1	13/64	5 3/32	33	42
UC317-307D1	F317D1	C(CM)-UCF317-307D1				
UC318D1	F318D1	C(CM)-UCF318D1	5	129	19	23
UC318-307D1	F318D1	C(CM)-UCF318-307D1	13/64	5 3/32	42	51
UC318-308D1	F318D1	C(CM)-UCF318-308D1				

Square flanged unit, cast housing Set screw type

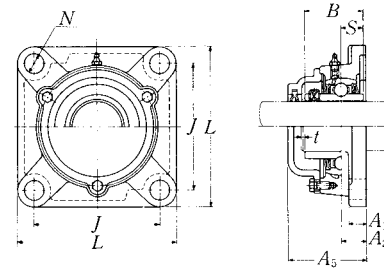
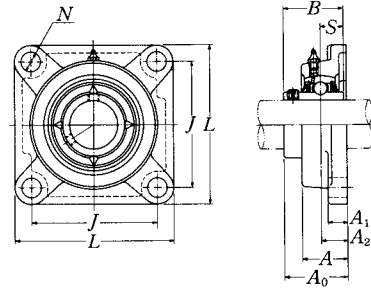

Cast dust cover type
Open end **C-UCF...D1**
Closed end **CM-UCF...D1**

Shaft dia. mm inch	Unit number ⁽¹⁾	Nominal dimensions										Bolt size mm inch
		mm inch										
		L	J	A ₂	A ₁	A	N	A ₀	B	S		
95 3 5/8 3 1/16 3 3/4	UCF319D1 UCF319-310D1 UCF319-311D1 UCF319-312D1	290 11 13/32	228 8 31/32	59 2 21/64	30 1 3/16	94 3 11/16	35 1 3/8	121 4 49/64	103 4.0551	41 1.614	M30 1 1/8	
100 3 13/16 3 7/8 3 15/16 4	UCF320D1 UCF320-313D1 UCF320-314D1 UCF320-315D1 UCF320-400D1	310 12 7/32	242 9 17/32	59 2 21/64	32 1 1/4	94 3 11/16	38 1 1/2	125 4 59/64	108 4.2520	42 1.654	M33 1 1/4	
105	UCF321D1	310	242	59	32	94	38	127	112	44	M33	
110	UCF322D1	340	266	60	35	96	41	131	117	46	M36	
120	UCF324D1	370	290	65	40	110	41	140	126	51	M36	
130	UCF326D1	410	320	65	45	115	41	146	135	54	M36	
140	UCF328D1	450	350	75	55	125	41	161	145	59	M36	

Note ⁽¹⁾ These numbers indicate relubricatable type. If maintenance free type is needed, please order without suffix "D1".

Remarks Please refer to page A21 for size of grease fitting.

Bearing number	Housing number	Unit number ⁽¹⁾ cast dust cover type	Nominal dimensions		Mass of unit	
			mm t max.	inch A ₅	kg	lb
					UCF	C(CM)
UC319D1	F319D1	C(CM)-UCF319D1	5	149	22	25
UC319-310D1	F319D1	C(CM)-UCF319-310D1				
UC319-311D1	F319D1	C(CM)-UCF319-311D1	13/64	5 7/8	49	55
UC319-312D1	F319D1	C(CM)-UCF319-312D1				
UC320D1	F320D1	C(CM)-UCF320D1	5	154	27	32
UC320-313D1	F320D1	C(CM)-UCF320-313D1				
UC320-314D1	F320D1	C(CM)-UCF320-314D1	13/64	6 1/16	60	71
UC320-315D1	F320D1	C(CM)-UCF320-315D1				
UC320-400D1	F320D1	C(CM)-UCF320-400D1				
UC321D1	F321D1	C(CM)-UCF321D1	5	156	26	32
UC322D1	F322D1	C(CM)-UCF322D1	5	160	34	40
UC324D1	F324D1	C(CM)-UCF324D1	5	172	48	56
UC326D1	F326D1	C(CM)-UCF326D1	6	178	63	73
UC328D1	F328D1	C(CM)-UCF328D1	6	192	90	100

Square flanged unit, cast housing Set screw type

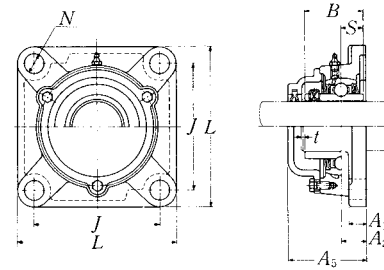
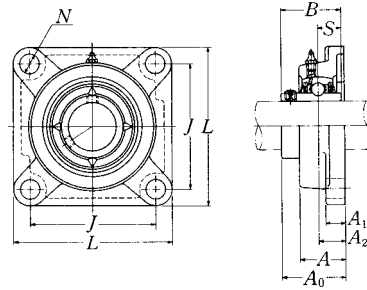

Cast dust cover type
Open end **C-UCF...D1**
Closed end **CM-UCF...D1**

Shaft dia. mm inch	Unit number (1)	Nominal dimensions									Bolt size mm inch
		mm inch									
		L	J	A ₂	A ₁	A	N	A ₀	B	S	
25 13/16 7/8 15/16 1	UCFX05D1 UCFX05-013D1 UCFX05-014D1 UCFX05-015D1 UCFX05-100D1	108 4 1/4	83 3 17/64	18 45/64	13 1/2	30 1 3/16	12 15/32	40.2 1 37/64	38.1 1.5000	15.9 0.626	M10 3/8
30 1 1/16 1 1/8 1 3/8 1 1/4	UCFX06D1 UCFX06-101D1 UCFX06-102D1 UCFX06-103D1 UCFX06-104D1	117 4 19/32	92 3 5/8	19 3/4	14 9/16	34 1 11/32	16 5/8	44.4 1 3/4	42.9 1.6890	17.5 0.689	M14 1/2
35 1 5/16 1 3/8 1 7/16	UCFX07D1 UCFX07-105D1 UCFX07-106D1 UCFX07-107D1	130 5 1/8	102 4 1/64	21 53/64	14 9/16	38 1 1/2	16 5/8	51.2 2 1/64	49.2 1.9370	19 0.748	M14 1/2
40 1 1/2 1 9/16	UCFX08D1 UCFX08-108D1 UCFX08-109D1	137 5 19/32	105 4 9/64	22 55/64	14 9/16	40 1 9/16	19 3/4	52.2 2 1/16	49.2 1.9370	19 0.748	M16 5/8
45 1 5/8 1 11/16 1 3/4 1 13/16	UCFX09D1 UCFX09-110D1 UCFX09-111D1 UCFX09-112D1 UCFX09-113D1	143 5 5/8	111 4 3/8	23 29/32	14 9/16	40 1 9/16	19 3/4	55.6 2 3/16	51.6 2.0315	19 0.748	M16 5/8
50 1 7/8 1 15/16 2	UCFX10D1 UCFX10-114D1 UCFX10-115D1 UCFX10-200D1	162 6 3/8	130 5 1/8	26 1 1/32	20 25/32	44 1 23/32	19 3/4	59.4 2 11/32	55.6 2.1890	22.2 0.874	M16 5/8

Note (1) These numbers indicate relubricatable type. If maintenance free type is needed, please order without suffix "D1".

Remarks Please refer to page A21 for size of grease fitting.

Bearing number	Housing number	Unit number (1) cast dust cover type	Nominal dimensions		Mass of unit	
			t max.	A ₅	UCF	C(CM)
			mm	inch	kg	lb
UCX05D1 UCX05-013D1 UCX05-014D1 UCX05-015D1 UCX05-100D1	FX05D1 FX05D1 FX05D1 FX05D1 FX05D1	C(CM)-UCFX05D1 C(CM)-UCFX05-013D1 C(CM)-UCFX05-014D1 C(CM)-UCFX05-015D1 C(CM)-UCFX05-100D1	2 5/64	56 2 7/32	1.1 2.4	1.3 2.9
UCX06D1 UCX06-101D1 UCX06-102D1 UCX06-103D1 UC207-104D1	FX06D1 FX06D1 FX06D1 FX06D1 FX06D1	C(CM)-UCFX06D1 C(CM)-UCFX06-101D1 C(CM)-UCFX06-102D1 C(CM)-UCFX06-103D1 C(CM)-UCFX06-104D1	2 5/64	59 2 5/16	1.7 3.7	1.9 4.2
UCX07D1 UCX07-105D1 UCX07-106D1 UCX07-107D1	FX07D1 FX07D1 FX07D1 FX07D1	C(CM)-UCFX07D1 C(CM)-UCFX07-105D1 C(CM)-UCFX07-106D1 C(CM)-UCFX07-107D1	3 1/8	66 2 19/32	2.1 4.6	2.5 5.5
UCX08D1 UCX08-108D1 UCX08-109D1	FX08D1 FX08D1 FX08D1	C(CM)-UCFX08D1 C(CM)-UCFX08-108D1 C(CM)-UCFX08-109D1	3 1/8	70 2 3/4	2.3 5.1	2.7 6.0
UCX09D1 UCX09-110D1 UCX09-111D1 UCX09-112D1 UC210-113D1	FX09D1 FX09D1 FX09D1 FX09D1 FX09D1	C(CM)-UCFX09D1 C(CM)-UCFX09-110D1 C(CM)-UCFX09-111D1 C(CM)-UCFX09-112D1 C(CM)-UCFX09-113D1	3 1/8	73 2 7/8	2.5 5.5	3.0 6.6
UCX10D1 UCX10-114D1 UCX10-115D1 UC211-200D1	FX10D1 FX10D1 FX10D1 FX10D1	C(CM)-UCFX10D1 C(CM)-UCFX10-114D1 C(CM)-UCFX10-115D1 C(CM)-UCFX10-200D1	3 1/8	76 3	3.8 8.4	4.3 9.5

Square flanged unit, cast housing Set screw type

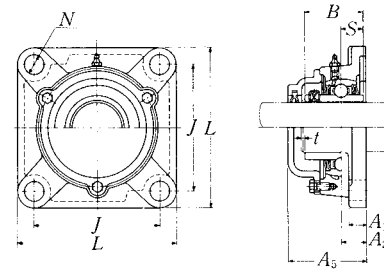
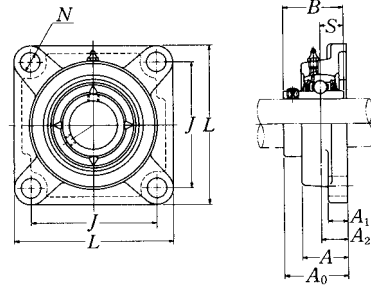

Cast dust cover type
Open end **C-UCF...D1**
Closed end **CM-UCF...D1**

Shaft dia. mm inch	Unit number (1)	Nominal dimensions									Bolt size mm inch
		mm inch									
		L	J	A ₂	A ₁	A	N	A ₀	B	S	
55	UCFX11D1	175	143	29	20	49	19	68.7	65.1	25.4	M16
2 1/16	UCFX11-201D1										
2 1/8	UCFX11-202D1										
2 3/16	UCFX11-203D1	6 7/8	5 5/8	1 9/64	25/32	1 15/16	3/4	2 45/64	2.5630	1.000	5/8
2 1/4	UCFX11-204D1										
2 5/16	UCFX11-205D1										
60	UCFX12D1	187	149	34	21	59	19	73.7	65.1	25.4	M16
2 3/8	UCFX12-206D1										
2 7/16	UCFX12-207D1	7 3/8	5 55/64	1 11/32	13/16	2 5/16	3/4	2 29/32	2.5630	1.000	5/8
65	UCFX13D1	187	149	34	21	59	19	78.4	74.6	30.2	M16
2 1/2	UCFX13-208D1										
2 9/16	UCFX13-209D1	7 3/8	5 55/64	1 11/32	13/16	2 5/16	3/4	3 3/32	2.9370	1.189	5/8
70	UCFX14D1	197	152	37	24	60	23	81.5	77.8	33.3	M20
2 5/8	UCFX14-210D1										
2 11/16	UCFX14-211D1										
2 3/4	UCFX14-212D1	7 3/4	5 53/64	1 29/64	15/16	2 3/8	29/32	3 13/64	3.0630	1.311	3/4
75	UCFX15D1	197	152	40	24	68	23	89.3	82.6	33.3	M20
2 13/16	UCFX15-213D1										
2 7/8	UCFX15-214D1										
2 9/16	UCFX15-215D1	7 3/4	5 53/64	1 37/64	15/16	2 11/16	29/32	3 33/64	3.2520	1.311	3/4
3	UCFX15-300D1										
80	UCFX16D1	214	171	40	24	70	23	91.6	85.7	34.1	M20
3 1/16	UCFX16-301D1										
3 1/8	UCFX16-302D1										
3 3/16	UCFX16-303D1	8 7/16	6 47/64	1 37/64	15/16	2 3/4	29/32	3 39/64	3.3740	1.343	3/4
3 1/4	UCFX16-304D1										

Note (1) These numbers indicate relubricatable type. If maintenance free type is needed, please order without suffix "D1".

Remarks Please refer to page A21 for size of grease fitting.

Bearing number	Housing number	Unit number (1) cast dust cover type	Nominal dimensions		Mass of unit	
			mm inch	kg lb	UCF	C(CM)
			t max.	A ₅		
UCX11D1	FX11D1	C(CM)-UCFX11D1	4	86	4.8	5.5
UCX11-201D1	FX11D1	C(CM)-UCFX11-201D1				
UCX11-202D1	FX11D1	C(CM)-UCFX11-202D1				
UCX11-203D1	FX11D1	C(CM)-UCFX11-203D1	5/32	3 3/8	11	12
UC212-204D1	FX11D1	C(CM)-UCFX11-204D1				
UC212-205D1	FX11D1	C(CM)-UCFX11-205D1				
UCX12D1	FX12D1	C(CM)-UCFX12D1	4	94	6.4	7.3
UCX12-206D1	FX12D1	C(CM)-UCFX12-206D1	5/32	3 11/16	14	16
UCX12-207D1	FX12D1	C(CM)-UCFX12-207D1				
UCX13D1	FX13D1	C(CM)-UCFX13D1	4	101	6.7	7.8
UCX13-208D1	FX13D1	C(CM)-UCFX13-208D1	5/32	3 31/32	15	17
UCX13-209D1	FX13D1	C(CM)-UCFX13-209D1				
UCX14D1	FX14D1	C(CM)-UCFX14D1	4	105	7.1	8.3
UCX14-210D1	FX14D1	C(CM)-UCFX14-210D1				
UCX14-211D1	FX14D1	C(CM)-UCFX14-211D1	5/32	4 1/8	16	18
UCX14-212D1	FX14D1	C(CM)-UCFX14-212D1				
UCX15D1	FX15D1	C(CM)-UCFX15D1	4	112	8.6	9.9
UCX15-213D1	FX15D1	C(CM)-UCFX15-213D1				
UCX15-214D1	FX15D1	C(CM)-UCFX15-214D1				
UCX15-215D1	FX15D1	C(CM)-UCFX15-215D1	5/32	4 13/32	19	22
UCX15-300D1	FX15D1	C(CM)-UCFX15-300D1				
UCX16D1	FX16D1	C(CM)-UCFX16D1	4	118	11	12
UCX16-301D1	FX16D1	C(CM)-UCFX16-301D1				
UCX16-302D1	FX16D1	C(CM)-UCFX16-302D1	5/32	4 21/32	24	26
UCX16-303D1	FX16D1	C(CM)-UCFX16-303D1				
UC217-304D1	FX16D1	C(CM)-UCFX16-304D1				

Square flanged unit, cast housing Set screw type

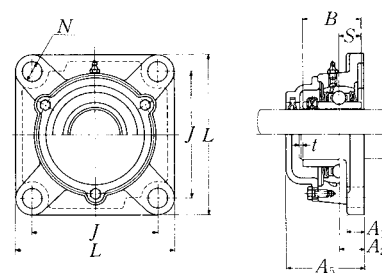
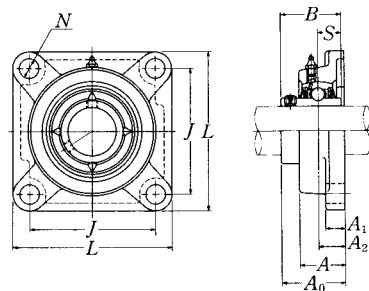

Cast dust cover type
Open end **C-UCF...D1**
Closed end **CM-UCF...D1**

Shaft dia. mm inch	Unit number (1)	Nominal dimensions									Bolt size mm inch
		mm inch									
		L	J	A ₂	A ₁	A	N	A ₀	B	S	
85	UCFX17D1	214	171	40	24	70	23	96.3	96	39.7	M20
3 ⁵ / ₁₆	UCFX17-305D1	8 ⁷ / ₁₆	6 ⁴⁷ / ₆₄	1 ³⁷ / ₆₄	1 ⁵ / ₁₆	2 ³ / ₄	2 ⁹ / ₃₂	3 ⁵¹ / ₆₄	3.7795	1.563	3/4
3 ⁷ / ₁₆	UCFX17-307D1										
90	UCFX18D1	214	171	45	24	76	23	106.1	104	42.9	M20
3 ⁷ / ₁₆	UCFX18-307D1	8 ⁷ / ₁₆	6 ⁴⁷ / ₆₄	1 ⁴⁹ / ₆₄	1 ⁵ / ₁₆	3	2 ⁹ / ₃₂	4 ¹¹ / ₆₄	4.0945	1.689	3/4
3 ¹ / ₂	UCFX18-308D1										
100	UCFX20D1	268	211	59	31	97	31	127.3	117.5	49.2	M27
3 ¹³ / ₁₆	UCFX20-313D1										
3 ⁷ / ₈	UCFX20-314D1										
3 ¹⁵ / ₁₆	UCFX20-315D1	10 ⁹ / ₁₆	8 ⁵ / ₁₆	2 ²¹ / ₆₄	1 ⁷ / ₃₂	3 ¹³ / ₁₆	1 ⁷ / ₃₂	5 ¹ / ₆₄	4.6260	1.937	1
4	UCFX20-400D1										

Note (1) These numbers indicate relubricatable type. If maintenance free type is needed, please order without suffix "D1".

Remarks Please refer to page A21 for size of grease fitting.

Bearing number	Housing number	Unit number (1) cast dust cover type	Nominal dimensions		Mass of unit	
			mm inch	A ₅	kg	lb
			t max.		UCF	C(CM)
UCX17D1	FX17D1	C(CM)-UCFX17D1	5	122	12	14
UCX17-305D1	FX17D1	C(CM)-UCFX17-305D1	1 ¹³ / ₆₄	4 ¹³ / ₁₆	26	31
UCX17-307D1	FX17D1	C(CM)-UCFX17-307D1				
UCX18D1	FX18D1	C(CM)-UCFX18D1	5	135	13	15
UCX18-307D1	FX18D1	C(CM)-UCFX18-307D1	1 ¹³ / ₆₄	5 ⁵ / ₁₆	29	33
UCX18-308D1	FX18D1	C(CM)-UCFX18-308D1				
UCX20D1	FX20D1	C(CM)-UCFX20D1	5	146.5	21	23
UCX20-313D1	FX20D1	C(CM)-UCFX20-313D1				
UCX20-314D1	FX20D1	C(CM)-UCFX20-314D1				
UCX20-315D1	FX20D1	C(CM)-UCFX20-315D1	1 ¹³ / ₆₄	5 ²⁵ / ₃₂	46	51
UCX20-400D1	FX20D1	C(CM)-UCFX20-400D1				

Square flanged unit, cast housing with spigot joint Set screw type

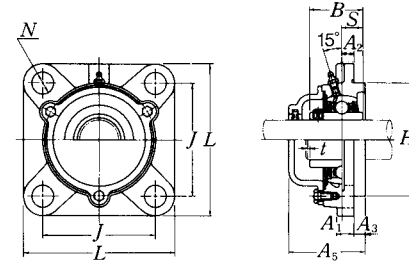
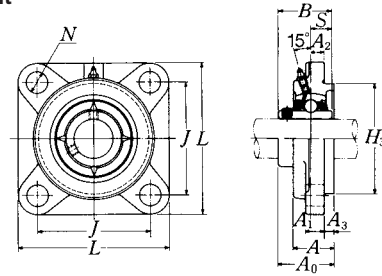

Cast dust cover type
Open end **C-UCFS...D1**
Closed end **CM-UCFS...D1**

Shaft dia. mm inch	Unit number (1)	Nominal dimensions											Bolt size mm inch
		mm inch											
		L	J	A ₂	N	A ₃	A ₁	A	H ₃	A ₀	B	S	
25	UCFS305D1	110	80	9	16	7	13	29	80	39	38	15	M14
$\frac{13}{16}$	UCFS305-013D1												
$\frac{7}{8}$	UCFS305-014D1	$4\frac{11}{32}$	$3\frac{5}{32}$	$\frac{23}{64}$	$\frac{5}{8}$	$\frac{9}{32}$	$\frac{1}{2}$	$1\frac{9}{64}$	3.1496	$1\frac{17}{32}$	1.4961	0.591	$\frac{1}{2}$
$\frac{15}{16}$	UCFS305-015D1												
1	UCFS305-100D1												
30	UCFS306D1	125	95	10	16	8	15	32	90	44	43	17	M14
$1\frac{1}{16}$	UCFS306-101D1												
$1\frac{1}{8}$	UCFS306-102D1	$4\frac{29}{32}$	$3\frac{47}{64}$	$\frac{25}{64}$	$\frac{5}{8}$	$\frac{5}{16}$	$\frac{19}{32}$	$1\frac{17}{64}$	3.5433	$1\frac{47}{64}$	1.6929	0.669	$\frac{1}{2}$
$1\frac{3}{16}$	UCFS306-103D1												
35	UCFS307D1	135	100	11	19	9	16	36	100	49	48	19	M16
$1\frac{1}{4}$	UCFS307-104D1												
$1\frac{5}{16}$	UCFS307-105D1												
$1\frac{3}{8}$	UCFS307-106D1	$5\frac{5}{16}$	$3\frac{15}{16}$	$\frac{7}{16}$	$\frac{3}{4}$	$\frac{23}{64}$	$\frac{5}{8}$	$1\frac{13}{32}$	3.9370	$1\frac{59}{64}$	1.8898	0.748	$\frac{5}{8}$
$1\frac{7}{16}$	UCFS307-107D1												
40	UCFS308D1	150	112	13	19	10	17	40	115	56	52	19	M16
$1\frac{1}{2}$	UCFS308-108D1												
$1\frac{9}{16}$	UCFS308-109D1	$5\frac{29}{32}$	$4\frac{13}{32}$	$\frac{33}{64}$	$\frac{3}{4}$	$\frac{25}{64}$	$\frac{21}{32}$	$1\frac{9}{16}$	4.5276	$2\frac{13}{64}$	2.0472	0.748	$\frac{5}{8}$
45	UCFS309D1	160	125	14	19	11	18	44	125	60	57	22	M16
$1\frac{5}{8}$	UCFS309-110D1												
$1\frac{11}{16}$	UCFS309-111D1	$6\frac{5}{16}$	$4\frac{59}{64}$	$\frac{35}{64}$	$\frac{3}{4}$	$\frac{7}{16}$	$\frac{23}{32}$	$1\frac{47}{64}$	4.9213	$2\frac{23}{64}$	2.2441	0.866	$\frac{5}{8}$
$1\frac{3}{4}$	UCFS309-112D1												
50	UCFS310D1	175	132	16	23	12	19	48	140	67	61	22	M20
$1\frac{13}{16}$	UCFS310-113D1												
$1\frac{7}{8}$	UCFS310-114D1	$6\frac{7}{8}$	$5\frac{13}{64}$	$\frac{5}{8}$	$\frac{29}{32}$	$\frac{15}{32}$	$\frac{3}{4}$	$1\frac{57}{64}$	5.5118	$2\frac{41}{64}$	2.4016	0.866	$\frac{3}{4}$
$1\frac{15}{16}$	UCFS310-115D1												

Note (1) These numbers indicate relubricatable type. If maintenance free type is needed, please order without suffix "D1".

Remarks Please refer to page A21 for size of grease fitting.

Bearing number	Housing number	Unit number (1) cast dust cover type	Nominal dimensions		Mass of unit	
			mm inch	A ₅	kg lb	UCFS C(CM)
			t max.			
UC305D1	FS305D1	C(CM)-UCFS305D1	2	56	1.2	1.4
UC305-013D1	FS305D1	C(CM)-UCFS305-013D1				
UC305-014D1	FS305D1	C(CM)-UCFS305-014D1	$\frac{5}{64}$	$2\frac{13}{64}$	2.6	3.1
UC305-015D1	FS305D1	C(CM)-UCFS305-015D1				
UC305-100D1	FS305D1	C(CM)-UCFS305-100D1				
UC306D1	FS306D1	C(CM)-UCFS306D1	2	60	1.8	2.2
UC306-101D1	FS306D1	C(CM)-UCFS306-101D1				
UC306-102D1	FS306D1	C(CM)-UCFS306-102D1	$\frac{5}{64}$	$2\frac{29}{64}$	4.0	4.9
UC306-103D1	FS306D1	C(CM)-UCFS306-103D1				
UC307D1	FS307D1	C(CM)-UCFS307D1	3	67	2.3	2.8
UC307-104D1	FS307D1	C(CM)-UCFS307-104D1				
UC307-105D1	FS307D1	C(CM)-UCFS307-105D1	$\frac{1}{8}$	$2\frac{41}{64}$	5.1	6.2
UC307-106D1	FS307D1	C(CM)-UCFS307-106D1				
UC307-107D1	FS307D1	C(CM)-UCFS307-107D1				
UC308D1	FS308D1	C(CM)-UCFS308D1	3	76	3.1	3.6
UC308-108D1	FS308D1	C(CM)-UCFS308-108D1	$\frac{1}{8}$	$2\frac{63}{64}$	6.8	7.9
UC308-109D1	FS308D1	C(CM)-UCFS308-109D1				
UC309D1	FS309D1	C(CM)-UCFS309D1	3	80	3.8	4.7
UC309-110D1	FS309D1	C(CM)-UCFS309-110D1				
UC309-111D1	FS309D1	C(CM)-UCFS309-111D1	$\frac{1}{8}$	$3\frac{5}{32}$	8.4	10
UC309-112D1	FS309D1	C(CM)-UCFS309-112D1				
UC310D1	FS310D1	C(CM)-UCFS310D1	3	88	5.0	6.2
UC310-113D1	FS310D1	C(CM)-UCFS310-113D1				
UC310-114D1	FS310D1	C(CM)-UCFS310-114D1	$\frac{1}{8}$	$3\frac{15}{32}$	11	14
UC310-115D1	FS310D1	C(CM)-UCFS310-115D1				

Square flanged unit, cast housing with spigot joint Set screw type

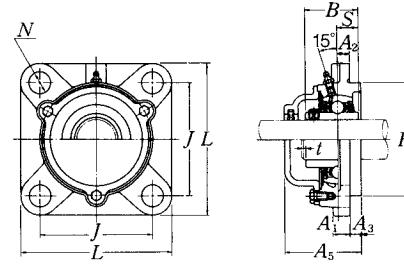
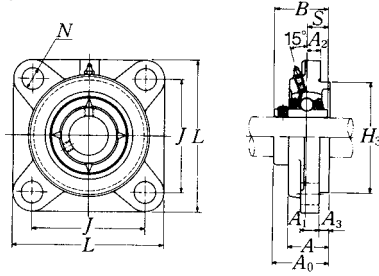

Cast dust cover type
Open end **C-UCFS...D1**
Closed end **CM-UCFS...D1**

Shaft dia. mm inch	Unit number (1)	Nominal dimensions										Bolt size mm inch	
		mm inch											
		L	J	A ₂	N	A ₃	A ₁	A	H ₃	A ₀	B	S	
55	UCFS311D1	185	140	17	23	13	20	52	150	71	66	25	M20
2	UCFS311-200D1												
2 1/16	UCFS311-201D1	7 9/32	5 33/64	43/64	29/32	33/64	25/32	2 3/64	5.9055	2 51/64	2.5984	0.984	3/4
2 1/8	UCFS311-202D1												
2 3/16	UCFS311-203D1												
60	UCFS312D1	195	150	19	23	14	22	56	160	78	71	26	M20
2 1/4	UCFS312-204D1												
2 5/16	UCFS312-205D1	7 11/16	5 29/32	3/4	29/32	35/64	7/8	2 13/64	6.2992	3 5/64	2.7953	1.024	3/4
2 3/8	UCFS312-206D1												
2 7/16	UCFS312-207D1												
65	UCFS313D1	208	166	15	23	18	22	58	175	78	75	30	M20
2 1/2	UCFS313-208D1												
2 9/16	UCFS313-209D1	8 3/16	6 17/32	19/32	29/32	45/64	7/8	2 9/32	6.8898	3 5/64	2.9528	1.181	3/4
70	UCFS314D1	226	178	18	25	18	25	61	185	81	78	33	M22
2 5/8	UCFS314-210D1												
2 11/16	UCFS314-211D1	8 29/32	7 1/64	45/64	63/64	45/64	31/32	2 13/32	7.2835	3 3/16	3.0709	1.299	7/8
2 3/4	UCFS314-212D1												
75	UCFS315D1	236	184	21	25	18	25	66	200	89	82	32	M22
2 13/16	UCFS315-213D1												
2 7/8	UCFS315-214D1	9 9/32	7 1/4	53/64	63/64	45/64	31/32	2 19/32	7.8740	3 1/2	3.2283	1.260	7/8
2 15/16	UCFS315-215D1												
3	UCFS315-300D1												
80	UCFS316D1	250	196	18	31	20	27	68	210	90	86	34	M27
3 1/16	UCFS316-301D1												
3 1/8	UCFS316-302D1	9 27/32	7 29/32	45/64	1 7/32	25/32	1 1/16	2 13/64	8.2677	3 35/64	3.3858	1.339	1
3 3/16	UCFS316-303D1												

Note (1) These numbers indicate relubricatable type. If maintenance free type is needed, please order without suffix "D1".
Remarks Please refer to page A21 for size of grease fitting.

Bearing number	Housing number	Unit number (1) cast dust cover type	Nominal dimensions		Mass of unit	
			mm inch	A ₅	UCFS	C(CM)
			t max.		kg	lb
UC311D1	FS311D1	C(CM)-UCFS311D1	4	93	5.9	7.2
UC311-200D1	FS311D1	C(CM)-UCFS311-200D1				
UC311-201D1	FS311D1	C(CM)-UCFS311-201D1	5/32	3 21/32	13	16
UC311-202D1	FS311D1	C(CM)-UCFS311-202D1				
UC311-203D1	FS311D1	C(CM)-UCFS311-203D1				
UC312D1	FS312D1	C(CM)-UCFS312D1	4	100	7.0	8.4
UC312-204D1	FS312D1	C(CM)-UCFS312-204D1				
UC312-205D1	FS312D1	C(CM)-UCFS312-205D1	5/32	3 15/16	15	19
UC312-206D1	FS312D1	C(CM)-UCFS312-206D1				
UC312-207D1	FS312D1	C(CM)-UCFS312-207D1				
UC313D1	FS313D1	C(CM)-UCFS313D1	4	103	8.6	10
UC313-208D1	FS313D1	C(CM)-UCFS313-208D1				
UC313-209D1	FS313D1	C(CM)-UCFS313-209D1	5/32	4 1/16	19	22
UC314D1	FS314D1	C(CM)-UCFS314D1	4	106	10	12
UC314-210D1	FS314D1	C(CM)-UCFS314-210D1				
UC314-211D1	FS314D1	C(CM)-UCFS314-211D1	5/32	4 11/64	22	26
UC314-212D1	FS314D1	C(CM)-UCFS314-212D1				
UC315D1	FS315D1	C(CM)-UCFS315D1	4	114	12	14
UC315-213D1	FS315D1	C(CM)-UCFS315-213D1				
UC315-214D1	FS315D1	C(CM)-UCFS315-214D1	5/32	4 31/64	26	31
UC315-215D1	FS315D1	C(CM)-UCFS315-215D1				
UC315-300D1	FS315D1	C(CM)-UCFS315-300D1				
UC316D1	FS316D1	C(CM)-UCFS316D1	4	116	14	17
UC316-301D1	FS316D1	C(CM)-UCFS316-301D1				
UC316-302D1	FS316D1	C(CM)-UCFS316-302D1	5/32	4 9/16	31	37
UC316-303D1	FS316D1	C(CM)-UCFS316-303D1				

Square flanged unit, cast housing with spigot joint Set screw type

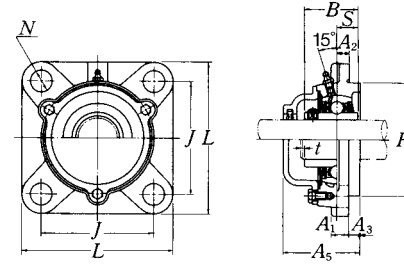
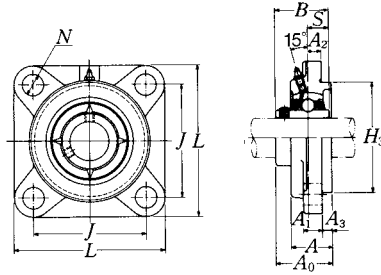

Cast dust cover type
Open end **C-UCFS...D1**
Closed end **CM-UCFS...D1**

Shaft dia. mm inch	Unit number (1)	Nominal dimensions											Bolt size mm inch
		mm inch											
		L	J	A ₂	N	A ₃	A ₁	A	H ₃	A ₀	B	S	
85 3 1/4	UCFS317D1	260	204	24	31	20	27	74	220	100	96	40	M27
3 5/16	UCFS317-304D1	10 1/4	8 1/32	15/16	1 7/32	25/32	1 1/16	2 29/32	8.6614	3 15/16	3.7795	1.575	1
3 7/16	UCFS317-305D1												
3 7/16	UCFS317-307D1												
90 3 7/16	UCFS318D1	280	216	24	35	20	30	76	240	100	96	40	M30
3 7/16	UCFS318-307D1	11 1/32	8 1/2	15/16	1 3/8	25/32	1 3/16	2 63/64	9.4488	3 15/16	3.7795	1.575	1 1/8
3 1/2	UCFS318-308D1												
95 3 5/8	UCFS319D1	290	228	39	35	20	30	94	250	121	103	41	M30
3 5/8	UCFS319-310D1												
3 11/16	UCFS319-311D1	11 13/32	8 31/32	1 17/32	1 3/8	25/32	1 3/16	3 15/64	9.8425	4 49/64	4.0551	1.614	1 1/8
3 3/4	UCFS319-312D1												
100 3 13/16	UCFS320D1	310	242	39	38	20	32	94	260	125	108	42	M33
3 13/16	UCFS320-313D1												
3 7/8	UCFS320-314D1												
3 15/16	UCFS320-315D1	12 7/32	9 17/32	1 17/32	1 1/2	25/32	1 1/4	3 45/64	10.2362	4 59/64	4.2520	1.654	1 1/4
4	UCFS320-400D1												
105	UCFS321D1	310	242	39	38	20	32	94	260	127	112	44	M33
110	UCFS322D1	340	266	35	41	25	35	96	300	131	117	46	M36
120	UCFS324D1	370	290	35	41	30	40	110	330	140	126	51	M36
130	UCFS326D1	410	320	35	41	30	45	115	360	146	135	54	M36
140	UCFS328D1	450	350	45	41	30	55	125	400	161	145	59	M36

Note (1) These numbers indicate relubricatable type. If maintenance free type is needed, please order without suffix "D1".

Remarks Please refer to page A21 for size of grease fitting.

Bearing number	Housing number	Unit number (1) cast dust cover type	Nominal dimensions		Mass of unit	
			mm inch		kg lb	
			t max.	A ₅	UCFS	C(CM)
UC317D1	FS317D1	C(CM)-UCFS317D1	5	129	17	20
UC317-304D1	FS317D1	C(CM)-UCFS317-304D1				
UC317-305D1	FS317D1	C(CM)-UCFS317-305D1	13/64	5 5/64	37	44
UC317-307D1	FS317D1	C(CM)-UCFS317-307D1				
UC318D1	FS318D1	C(CM)-UCFS318D1	5	129	20	24
UC318-307D1	FS318D1	C(CM)-UCFS318-307D1				
UC318-308D1	FS318D1	C(CM)-UCFS318-308D1	13/64	5 5/64	44	53
UC319D1	FS319D1	C(CM)-UCFS319D1	5	149	24	28
UC319-310D1	FS319D1	C(CM)-UCFS319-310D1				
UC319-311D1	FS319D1	C(CM)-UCFS319-311D1	13/64	5 55/64	53	62
UC319-312D1	FS319D1	C(CM)-UCFS319-312D1				
UC320D1	FS320D1	C(CM)-UCFS320D1	5	154	29	34
UC320-313D1	FS320D1	C(CM)-UCFS320-313D1				
UC320-314D1	FS320D1	C(CM)-UCFS320-314D1				
UC320-315D1	FS320D1	C(CM)-UCFS320-315D1	13/64	6 1/16	64	75
UC320-400D1	FS320D1	C(CM)-UCFS320-400D1				
UC321D1	FS321D1	C(CM)-UCFS321D1	5	156	28	33
UC322D1	FS322D1	C(CM)-UCFS322D1	5	160	38	45
UC324D1	FS324D1	C(CM)-UCFS324D1	5	172	52	59
UC326D1	FS326D1	C(CM)-UCFS326D1	6	178	69	77
UC328D1	FS328D1	C(CM)-UCFS328D1	6	192	98	109

Round flanged unit, cast housing with spigot joint Set screw type

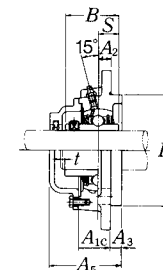
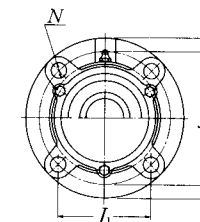
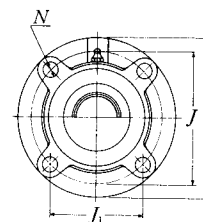
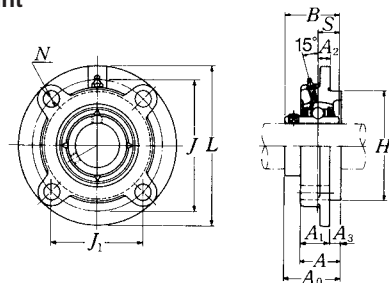

Pressed steel dust cover type
Open end **Z-UCFC...D1**
Closed end **ZM-UCFC...D1**

Cast dust cover type
Open end **C-UCFC...D1**
Closed end **CM-UCFC...D1**

Shaft dia. mm inch	Unit number (1)	Nominal dimensions													Bolt size mm inch
		mm inch													
		L	J	(J ₁)	A ₂	N	A ₃	A ₁	A	H ₃	A ₀	B	S		
12 1/2	UCFC201D1 UCFC201-008D1	100 3 15/16	78 3 5/8	55.2 2 11/64	10 25/64	12 15/32	5 13/64	20.5 13/16	25.5 1	62 2.4409	33.3 1 15/16	31 1.2205	12.7 0.500	M10 3/8	
15 9/16 5/8	UCFC202D1 UCFC202-009D1 UCFC202-010D1	100 3 15/16	78 3 5/8	55.2 2 11/64	10 25/64	12 15/32	5 13/64	20.5 13/16	25.5 1	62 2.4409	33.3 1 15/16	31 1.2205	12.7 0.500	M10 3/8	
17 13/16	UCFC203D1 UCFC203-011D1	100 3 15/16	78 3 5/8	55.2 2 11/64	10 25/64	12 15/32	5 13/64	20.5 13/16	25.5 1	62 2.4409	33.3 1 15/16	31 1.2205	12.7 0.500	M10 3/8	
20 3/4	UCFC204D1 UCFC204-012D1	100 3 15/16	78 3 5/8	55.2 2 11/64	10 25/64	12 15/32	5 13/64	20.5 13/16	25.5 1	62 2.4409	33.3 1 15/16	31 1.2205	12.7 0.500	M10 3/8	
25 13/16 7/8 15/16	UCFC205D1 UCFC205-013D1 UCFC205-014D1 UCFC205-015D1 UCFC205-100D1	115 4 17/32	90 3 35/64	63.6 2 1/2	10 25/64	12 15/32	6 15/64	21 13/16	27 1 1/16	70 2.7559	35.8 1 13/32	34.1 1.3425	14.3 0.563	M10 3/8	
30 1 1/16 1 1/8 1 3/16 1 1/4	UCFC206D1 UCFC206-101D1 UCFC206-102D1 UCFC206-103D1 UCFC206-104D1	125 4 23/32	100 3 15/16	70.7 2 25/32	10 25/64	12 15/32	8 5/16	23 29/32	31 1 7/32	80 3.1496	40.2 1 37/64	38.1 1.5000	15.9 0.629	M10 3/8	
35 1 1/4 1 5/16 1 3/8 1 7/16	UCFC207D1 UCFC207-104D1 UCFC207-105D1 UCFC207-106D1 UCFC207-107D1	135 5 5/16	110 4 21/64	77.8 3 3/16	11 7/16	14 35/64	8 5/16	26 1 1/32	34 1 11/32	90 3.5433	44.4 1 3/4	42.9 1.6890	17.5 0.689	M12 7/16	
40 1 1/2 1 9/16	UCFC208D1 UCFC208-108D1 UCFC208-109D1	145 5 23/32	120 4 23/32	84.9 3 11/32	11 7/16	14 35/64	10 25/64	26 1 1/32	36 1 27/64	100 3.9370	51.2 2 1/64	49.2 1.9370	19 0.748	M12 7/16	
45 1 5/8 1 11/16 1 3/4	UCFC209D1 UCFC209-110D1 UCFC209-111D1 UCFC209-112D1	160 6 5/16	132 5 13/64	93.3 3 43/64	10 25/64	16 5/8	12 15/32	26 1 1/32	38 1 1/2	105 4.1339	52.2 2 3/64	49.2 1.9370	19 0.748	M14 1/2	

Note (1) These numbers indicate relubricatable type. If maintenance free type is needed, please order without suffix "D1".

Remarks Please refer to page A21 for size of grease fitting.

Bearing number	Housing number	Unit number (1) pressed steel dust cover type	Unit number (1) cast dust cover type	Nominal dimensions				Mass of unit		
				mm inch				kg lb		
				t max.	A ₄	A _{1C}	A ₅	UCFC	Z(ZM)	C(CM)
UC201D1	FC204D1	Z(ZM)-UCFC201D1	C(CM)-UCFC201D1	2	38	20.5	46	0.8	0.8	0.9
UC201-008D1	FC204D1	Z(ZM)-UCFC201-008D1	C(CM)-UCFC201-008D1	5/64	1 1/2	13/16	1 13/16	1.8	1.8	2.0
UC202D1	FC204D1	Z(ZM)-UCFC202D1	C(CM)-UCFC202D1	2	38	20.5	46	0.8	0.8	0.9
UC202-009D1	FC204D1	Z(ZM)-UCFC202-009D1	C(CM)-UCFC202-009D1	5/64	1 1/2	13/16	1 13/16	1.8	1.8	2.0
UC202-010D1	FC204D1	Z(ZM)-UCFC202-010D1	C(CM)-UCFC202-010D1							
UC203D1	FC204D1	Z(ZM)-UCFC203D1	C(CM)-UCFC203D1	2	38	20.5	46	0.8	0.8	0.9
UC203-011D1	FC204D1	Z(ZM)-UCFC203-011D1	C(CM)-UCFC203-011D1	5/64	1 1/2	13/16	1 13/16	1.8	1.8	2.0
UC204D1	FC204D1	Z(ZM)-UCFC204D1	C(CM)-UCFC204D1	2	38	20.5	46	0.7	0.7	0.9
UC204-012D1	FC204D1	Z(ZM)-UCFC204-012D1	C(CM)-UCFC204-012D1	5/64	1 1/2	13/16	1 13/16	1.5	1.5	2.0
UC205D1	FC205D1	Z(ZM)-UCFC205D1	C(CM)-UCFC205D1	2	40	22	51	1.0	1.0	1.2
UC205-013D1	FC205D1	Z(ZM)-UCFC205-013D1	C(CM)-UCFC205-013D1							
UC205-014D1	FC205D1	Z(ZM)-UCFC205-014D1	C(CM)-UCFC205-014D1							
UC205-015D1	FC205D1	Z(ZM)-UCFC205-015D1	C(CM)-UCFC205-015D1	5/64	1 19/32	7/8	2	2.2	2.2	2.6
UC205-100D1	FC205D1	Z(ZM)-UCFC205-100D1	C(CM)-UCFC205-100D1							
UC206D1	FC206D1	Z(ZM)-UCFC206D1	C(CM)-UCFC206D1	2	45	24.5	56	1.3	1.4	1.6
UC206-101D1	FC206D1	Z(ZM)-UCFC206-101D1	C(CM)-UCFC206-101D1							
UC206-102D1	FC206D1	Z(ZM)-UCFC206-102D1	C(CM)-UCFC206-102D1							
UC206-103D1	FC206D1	Z(ZM)-UCFC206-103D1	C(CM)-UCFC206-103D1	5/64	1 3/4	31/32	2 13/64	2.9	3.1	3.5
UC206-104D1	FC206D1	—	C(CM)-UCFC206-104D1							
UC207D1	FC207D1	Z(ZM)-UCFC207D1	C(CM)-UCFC207D1	3	49	26	59	1.6	1.7	1.9
UC207-104D1	FC207D1	Z(ZM)-UCFC207-104D1	C(CM)-UCFC207-104D1							
UC207-105D1	FC207D1	Z(ZM)-UCFC207-105D1	C(CM)-UCFC207-105D1							
UC207-106D1	FC207D1	Z(ZM)-UCFC207-106D1	C(CM)-UCFC207-106D1	1/8	1 15/16	1 1/32	2 21/64	3.5	3.7	4.2
UC207-107D1	FC207D1	—	C(CM)-UCFC207-107D1							
UC208D1	FC208D1	Z(ZM)-UCFC208D1	C(CM)-UCFC208D1	3	56	27.5	66	2.0	2.1	2.4
UC208-108D1	FC208D1	Z(ZM)-UCFC208-108D1	C(CM)-UCFC208-108D1							
UC208-109D1	FC208D1	Z(ZM)-UCFC208-109D1	C(CM)-UCFC208-109D1	1/8	2 3/16	1 5/64	2 19/32	4.4	4.6	5.3
UC209D1	FC209D1	Z(ZM)-UCFC209D1	C(CM)-UCFC209D1	3	57	28	70	2.7	2.7	3.2
UC209-110D1	FC209D1	Z(ZM)-UCFC209-110D1	C(CM)-UCFC209-110D1							
UC209-111D1	FC209D1	Z(ZM)-UCFC209-111D1	C(CM)-UCFC209-111D1	1/8	2 1/4	1 7/64	2 3/4	6.0	6.0	7.1
UC209-112D1	FC209D1	Z(ZM)-UCFC209-112D1	C(CM)-UCFC209-112D1							

Round flanged unit, cast housing with spigot joint Set screw type

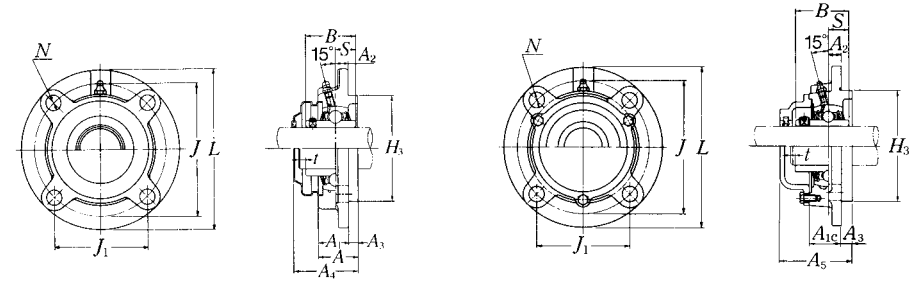
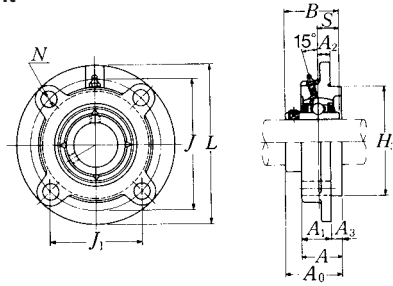

Pressed steel dust cover type
Open end **Z-UCFC...D1**
Closed end **ZM-UCFC...D1**

Cast dust cover type
Open end **C-UCFC...D1**
Closed end **CM-UCFC...D1**

Shaft dia. mm inch	Unit number ⁽¹⁾	Nominal dimensions												Bolt size mm inch
		mm inch												
		L	J	(J ₁)	A ₂	N	A ₃	A ₁	A	H ₃	A ₀	B	S	
85	UCFC217D1	250	208	147.1	18	23	18	45	63	180	87.6	85.7	34.1	M20
3 1/4	UCFC217-304D1													
3 5/16	UCFC217-305D1	9 27/32	8 3/16	5 51/64	45/64	29/32	45/64	1 25/32	2 31/64	7.0866	3 29/64	3.3740	1.343	3/4
3 7/16	UCFC217-307D1													
90	UCFC218D1	265	220	155.6	22	23	18	50	68	190	96.3	96	39.7	M20
3 1/2	UCFC218-308D1	10 7/16	8 21/32	6 1/8	55/64	29/32	45/64	1 31/32	2 43/64	7.4803	3 51/64	3.7795	1.563	3/4

Bearing number	Housing number	Unit number ⁽¹⁾ pressed steel dust cover type	Unit number ⁽¹⁾ cast dust cover type	Nominal dimensions				Mass of unit		
				mm inch				kg lb		
				t max.	A ₄	A _{1C}	A ₅	UCFC	Z(ZM)	C(CM)
UC217D1	FC217D1	—	C(CM)-UCFC217D1	5	—	45.5	114	11	—	12
UC217-304D1	FC217D1		C(CM)-UCFC217-304D1							
UC217-305D1	FC217D1	—	C(CM)-UCFC217-305D1	13/64	—	1 51/64	4 31/64	24	—	26
UC217-307D1	FC217D1		C(CM)-UCFC217-307D1							
UC218D1	FC218D1	—	C(CM)-UCFC218D1	5	—	50	122	13	—	15
UC218-308D1	FC218D1	—	C(CM)-UCFC218-308D1	13/64	—	1 31/32	4 51/64	29	—	33

Note ⁽¹⁾ These numbers indicate relubricatable type. If maintenance free type is needed, please order without suffix "D1".
Remarks Please refer to page A21 for size of grease fitting.

Round flanged unit, cast housing with spigot joint Set screw type

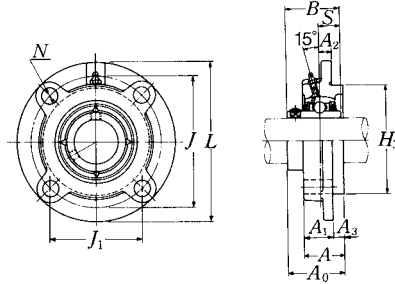

Shaft dia. mm inch	Unit number ⁽¹⁾	Nominal dimensions												Bolt size mm inch
		mm inch												
		L	J	(J ₁)	A ₂	N	A ₃	A ₁	A	H ₃	A ₀	B	S	
25 1 3/16	UCFCX05D1	111	92	65.1	10	9.5	6	24	30	76	38.2	38.1	15.9	M8
	UCFCX05-013D1													
	UCFCX05-014D1	4 3/8	3 5/8	2 9/16	25/64	3/8	1/4	15/16	1 3/16	2.9921	1 1/2	1.5000	0.626	5/16
	UCFCX05-015D1													
1 1 1/16	UCFCX05-100D1													
30 1 1/8	UCFCX06D1	127	105	74.2	8	12	9.5	22.5	32	85	42.9	42.9	17.5	M10
	UCFCX06-101D1													
	UCFCX06-102D1	5	4 9/64	2 59/64	5/16	15/32	3/8	7/8	1 27/64	3.3465	1 11/16	1.6890	0.689	3/8
	UCFCX06-103D1													
	UCFCX06-104D1													
35 1 5/16	UCFCX07D1	133	111	78.5	9	12	11	26	37	92	50.2	49.2	19	M10
	UCFCX07-105D1													
	UCFCX07-106D1	5 1/4	4 3/8	3 3/32	23/64	15/32	7/16	1 1/32	1 29/64	3.6220	1 31/32	1.9370	0.748	3/8
	UCFCX07-107D1													
40 1 1/2	UCFCX08D1	133	111	78.5	9	12	11	26	37	92	50.2	49.2	19	M10
	UCFCX08-108D1													
	UCFCX08-109D1	5 1/4	4 3/8	3 3/32	23/64	15/32	7/16	1 1/32	1 29/64	3.6220	1 31/32	1.9370	0.748	3/8
45 1 5/8	UCFCX09D1	155	130	91.9	8	14	12	25	37	108	52.6	51.6	19	M12
	UCFCX09-110D1													
	UCFCX09-111D1	6 3/32	5 1/8	3 5/8	5/16	35/64	15/32	31/32	1 29/64	4.2520	2 5/64	2.0315	0.748	7/16
	UCFCX09-112D1													
	UCFCX09-113D1													
50 1 7/8	UCFCX10D1	162	136	96.2	7	14	16	25	41	118	56.4	55.6	22.2	M12
	UCFCX10-114D1													
	UCFCX10-115D1	6 3/8	5 23/64	3 25/32	9/32	35/64	5/8	31/32	1 39/64	4.6457	2 7/32	2.1890	0.874	7/16
2 1 15/16	UCFCX10-200D1													

Note (1) These numbers indicate relubricatable type. If maintenance free type is needed, please order without suffix "D1".

Remarks Please refer to page A21 for size of grease fitting.

Bearing number	Housing number ⁽¹⁾	Mass of unit kg lb
UCX05D1	FCX05D1	1.2
UCX05-013D1	FCX05D1	
UCX05-014D1	FCX05D1	2.6
UCX05-015D1	FCX05D1	
UCX05-100D1	FCX05D1	
UCX06D1	FCX06D1	1.7
UCX06-101D1	FCX06D1	
UCX06-102D1	FCX06D1	3.7
UCX06-103D1	FCX06D1	
UC207-104D1	FCX06D1	
UCX07D1	FCX07D1	1.9
UCX07-105D1	FCX07D1	
UCX07-106D1	FCX07D1	4.2
UCX07-107D1	FCX07D1	
UCX08D1	FCX08D1	2.0
UCX08-108D1	FCX08D1	4.4
UCX08-109D1	FCX08D1	
UCX09D1	FCX09D1	2.6
UCX09-110D1	FCX09D1	
UCX09-111D1	FCX09D1	5.7
UCX09-112D1	FCX09D1	
UC210-113D1	FCX09D1	
UCX10D1	FCX10D1	3.1
UCX10-114D1	FCX10D1	
UCX10-115D1	FCX10D1	6.8
UC211-200D1	FCX10D1	

Round flanged unit, cast housing with spigot joint Set screw type

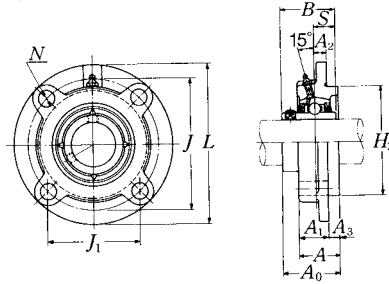

Shaft dia. mm inch	Unit number (1)	Nominal dimensions											Bolt size mm inch	
		mm inch												
		L	J	(J ₁)	A ₂	N	A ₃	A ₁	A	H ₃	A ₀	B	S	
55 2 1/16 2 1/8	UCFCX11D1 UCFCX11-201D1 UCFCX11-202D1	180	152	107.5	4	16	22	26	48	127	65.7	65.1	25.4	M14
2 3/16 2 1/4 2 5/16	UCFCX11-203D1 UCFCX11-204D1 UCFCX11-205D1	7 3/32	5 53/64	4 15/64	5/32	5/8	55/64	1 1/32	1 57/64	5.0000	2 19/32	2.5630	1.000	1/2
60 2 3/8 2 7/16	UCFCX12D1 UCFCX12-206D1 UCFCX12-207D1	194	165	116.7	11	16	20	33	53	140	70.7	65.1	25.4	M14
		7 5/8	6 1/2	4 19/32	7/16	5/8	25/32	1 5/16	2 5/64	5.5118	2 25/32	2.5630	1.000	1/2
65 2 1/2 2 9/16	UCFCX13D1 UCFCX13-208D1 UCFCX13-209D1	194	165	116.7	11	16	20	33	53	140	75.4	74.6	30.2	M14
		7 5/8	6 1/2	4 19/32	7/16	5/8	25/32	1 5/16	2 5/64	5.5118	2 31/32	2.9370	1.189	1/2
70 2 5/8 2 11/16 2 3/4	UCFCX14D1 UCFCX14-210D1 UCFCX14-211D1 UCFCX14-212D1	222	190	134.4	14	19	20	36	56	164	78.5	77.8	33.3	M16
		8 3/4	7 31/64	5 9/32	35/64	3/4	25/32	1 13/32	2 13/64	6.4567	3 3/32	3.0630	1.311	5/8
75 2 13/16 2 7/8 2 15/16 3	UCFCX15D1 UCFCX15-213D1 UCFCX15-214D1 UCFCX15-215D1 UCFCX15-300D1	222	190	134.4	12	19	22	35	57	164	83.3	82.6	33.3	M16
		8 3/4	7 31/64	5 9/32	15/32	3/4	55/64	1 3/8	2 1/4	6.4567	3 9/32	3.2520	1.311	5/8
80 3 1/16 3 1/8 3 3/16 3 1/4	UCFCX16D1 UCFCX16-301D1 UCFCX16-302D1 UCFCX16-303D1 UCFCX16-304D1	260	219	154.9	10	23	25	36	61	186	86.6	85.7	34.1	M20
		10 1/4	8 5/8	6 3/32	25/64	29/32	63/64	1 13/32	2 13/32	7.3228	3 13/32	3.3740	1.343	3/4
85 3 5/16 3 7/16	UCFCX17D1 UCFCX17-305D1 UCFCX17-307D1	260	219	154.9	10	23	25	36	61	186	91.3	96	39.7	M20
		10 1/4	8 5/8	6 3/32	25/64	29/32	63/64	1 13/32	2 13/32	7.3228	3 19/32	3.7795	1.563	3/4

Note (1) These numbers indicate relubricatable type. If maintenance free type is needed, please order without suffix "D1".

Remarks Please refer to page A21 for size of grease fitting.

Bearing number	Housing (1) number	Mass of unit kg lb
UCX11D1	FCX11D1	4.2
UCX11-201D1	FCX11D1	
UCX11-202D1	FCX11D1	
UCX11-203D1	FCX11D1	9.3
UC212-204D1	FCX11D1	
UC212-205D1	FCX11D1	
UCX12D1	FCX12D1	5.5
UCX12-206D1	FCX12D1	
UCX12-207D1	FCX12D1	12
UCX13D1	FCX13D1	5.7
UCX13-208D1	FCX13D1	
UCX13-209D1	FCX13D1	13
UCX14D1	FCX14D1	7.3
UCX14-210D1	FCX14D1	
UCX14-211D1	FCX14D1	16
UCX14-212D1	FCX14D1	
UCX15D1	FCX15D1	8.0
UCX15-213D1	FCX15D1	
UCX15-214D1	FCX15D1	
UCX15-215D1	FCX15D1	18
UCX15-300D1	FCX15D1	
UCX16D1	FCX16D1	12
UCX16-301D1	FCX16D1	
UCX16-302D1	FCX16D1	
UCX16-303D1	FCX16D1	26
UC217-304D1	FCX16D1	
UCX17D1	FCX17D1	12
UCX17-305D1	FCX17D1	
UCX17-307D1	FCX17D1	26

Round flanged unit, cast housing with spigot joint Set screw type

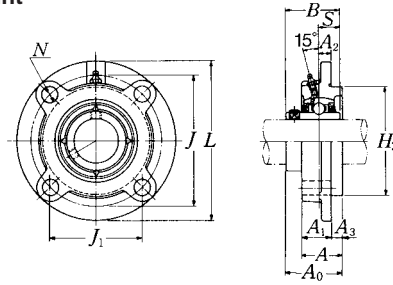

Shaft dia. mm inch	Unit number ⁽¹⁾	Nominal dimensions												Bolt size mm inch
		L	J	(J ₁)	A ₂	N	A ₃	A ₁	A	H ₃	A ₀	B	S	
90	UCFCX18D1	260	219	154.9	12	23	28	43	71	186	101.1	104	42.9	M20
3 ⁷ / ₁₆	UCFCX18-307D1	10 ¹ / ₄	8 ⁵ / ₈	6 ³ / ₃₂	15 ¹ / ₃₂	29 ²⁹ / ₃₂	1 ⁷ / ₆₄	1 ¹¹ / ₁₆	2 ⁵¹ / ₆₄	7.3228	3 ⁶³ / ₆₄	4.0945	1.689	3/4
3 ¹ / ₂	UCFCX18-308D1													
100	UCFCX20D1	276	238	168.3	22	23	28	66	94	206	118.3	117.5	49.2	M20
3 ¹³ / ₁₆	UCFCX20-313D1													
3 ⁷ / ₈	UCFCX20-314D1	10 ⁷ / ₈	9 ³ / ₈	6 ⁵ / ₈	55 ⁵⁵ / ₆₄	29 ²⁹ / ₃₂	1 ⁷ / ₆₄	2 ¹⁹ / ₃₂	3 ⁴⁵ / ₆₄	8.1102	4 ²¹ / ₃₂	4.6260	1.937	3/4
3 ¹⁵ / ₁₆	UCFCX20-315D1													
4	UCFCX20-400D1													

Note ⁽¹⁾ These numbers indicate relubricatable type. If maintenance free type is needed, please order without suffix "D1".

Remarks Please refer to page A21 for size of grease fitting.

Bearing number	Housing ⁽¹⁾ number	Mass of unit kg lb
UCX18D1	FCX18D1	12
UCX18-307D1	FCX18D1	26
UCX18-308D1	FCX18D1	
UCX20D1	FCX20D1	18
UCX20-313D1	FCX20D1	
UCX20-314D1	FCX20D1	40
UCX20-315D1	FCX20D1	
UCX20-400D1	FCX20D1	

Rhombus flanged unit, cast housing Set screw type

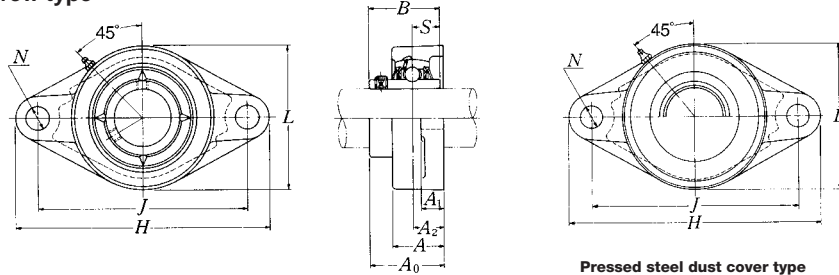

Pressed steel dust cover type
Open end **Z-UCFL...D1**
Closed end **ZM-UCFL...D1**

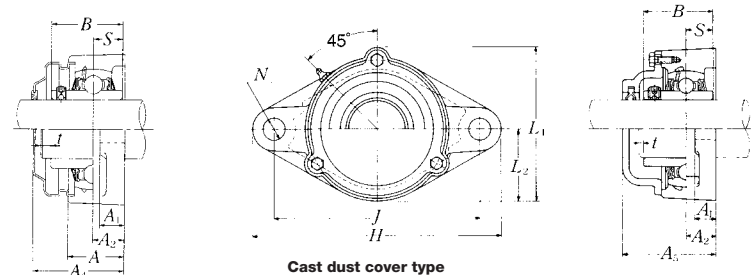

Cast dust cover type
Open end **C-UCFL...D1**
Closed end **CM-UCFL...D1**

Shaft dia. mm inch	Unit number (1)	Nominal dimensions										Bolt size mm inch	Bearing number
		mm inch											
		H	J	A ₂	A ₁	A	N	L	A ₀	B	S		
12	UCFL201D1	113	90	15	11	25.5	12	60	33.3	31	12.7	M10	UC201D1
1/2	UCFL201-008D1	4 7/16	3 35/64	19/32	7/16	1	15/32	2 3/8	1 5/16	1.2205	0.500	3/8	UC201-008D1
15	UCFL202D1	113	90	15	11	25.5	12	60	33.3	31	12.7	M10	UC202D1
9/16	UCFL202-009D1	4 7/16	3 35/64	19/32	7/16	1	15/32	2 3/8	1 5/16	1.2205	0.500	3/8	UC202-009D1
5/8	UCFL202-010D1	4 7/16	3 35/64	19/32	7/16	1	15/32	2 3/8	1 5/16	1.2205	0.500	3/8	UC202-010D1
17	UCFL203D1	113	90	15	11	25.5	12	60	33.3	31	12.7	M10	UC203D1
1 1/16	UCFL203-011D1	4 7/16	3 35/64	19/32	7/16	1	15/32	2 3/8	1 5/16	1.2205	0.500	3/8	UC203-011D1
20	UCFL204D1	113	90	15	11	25.5	12	60	33.3	31	12.7	M10	UC204D1
3/4	UCFL204-012D1	4 7/16	3 35/64	19/32	7/16	1	15/32	2 3/8	1 5/16	1.2205	0.500	3/8	UC204-012D1
25	UCFL205D1	130	99	16	13	27	16	68	35.8	34.1	14.3	M14	UC205D1
1 3/16	UCFL205-013D1												UC205-013D1
7/8	UCFL205-014D1												UC205-014D1
15/16	UCFL205-015D1	5 1/8	3 57/64	5/8	1/2	1 1/16	5/8	2 11/16	1 13/32	1.3425	0.563	1/2	UC205-015D1
1	UCFL205-100D1												UC205-100D1
30	UCFL206D1	148	117	18	13	31	16	80	40.2	38.1	15.9	M14	UC206D1
1 1/16	UCFL206-101D1												UC206-101D1
1 1/8	UCFL206-102D1												UC206-102D1
1 3/16	UCFL206-103D1	5 13/16	4 39/64	45/64	1/2	1 7/32	5/8	3 5/32	1 37/64	1.5000	0.626	1/2	UC206-103D1
1 1/4	UCFL206-104D1												UC206-104D1
35	UCFL207D1	161	130	19	15	34	16	90	44.4	42.9	17.5	M14	UC207D1
1 1/4	UCFL207-104D1												UC207-104D1
1 5/16	UCFL207-105D1												UC207-105D1
1 3/8	UCFL207-106D1	6 11/32	5 1/8	3/4	19/32	1 11/32	5/8	3 17/32	1 3/4	1.6890	0.689	1/2	UC207-106D1
1 7/16	UCFL207-107D1												UC207-107D1
40	UCFL208D1	175	144	21	15	36	16	100	51.2	49.2	19	M14	UC208D1
1 1/2	UCFL208-108D1												UC208-108D1
1 9/16	UCFL208-109D1	6 7/8	5 43/64	53/64	19/32	1 13/32	5/8	3 15/16	2 1/4	1.9370	0.748	1/2	UC208-109D1

Note (1) These numbers indicate relubricatable type. If maintenance free type is needed, please order without suffix "D1".
Remarks Please refer to page A21 for size of grease fitting.

Housing number	Unit number (1) pressed steel dust cover type	Unit number (1) cast dust cover type	Nominal dimensions					Mass of unit		
			mm inch					kg lb		
			t max.	A ₄	A ₅	L ₁	L ₂	UCFL	Z(ZM)	C(CM)
FL204D1	Z(ZM)-UCFL201D1	C(CM)-UCFL201D1	2	38	46	67	30	0.5	0.5	0.6
FL204D1	Z(ZM)-UCFL201-008D1	C(CM)-UCFL201-008D1	5/64	1 1/2	1 13/16	2 5/8	1 3/16	1.1	1.1	1.3
FL204D1	Z(ZM)-UCFL202D1	C(CM)-UCFL202D1	2	38	46	67	30	0.5	0.5	0.6
FL204D1	Z(ZM)-UCFL202-009D1	C(CM)-UCFL202-009D1	5/64	1 1/2	1 13/16	2 5/8	1 3/16	1.1	1.1	1.3
FL204D1	Z(ZM)-UCFL202-010D1	C(CM)-UCFL202-010D1	5/64	1 1/2	1 13/16	2 5/8	1 3/16	1.1	1.1	1.3
FL204D1	Z(ZM)-UCFL203D1	C(CM)-UCFL203D1	2	38	46	67	30	0.5	0.5	0.6
FL204D1	Z(ZM)-UCFL203-011D1	C(CM)-UCFL203-011D1	5/64	1 1/2	1 13/16	2 5/8	1 3/16	1.1	1.1	1.3
FL204D1	Z(ZM)-UCFL204D1	C(CM)-UCFL204D1	2	38	46	67	30	0.4	0.4	0.6
FL204D1	Z(ZM)-UCFL204-012D1	C(CM)-UCFL204-012D1	5/64	1 1/2	1 13/16	2 5/8	1 3/16	0.9	0.9	1.3
FL205D1	Z(ZM)-UCFL205D1	C(CM)-UCFL205D1	2	40	51	74	34	0.6	0.6	0.8
FL205D1	Z(ZM)-UCFL205-013D1	C(CM)-UCFL205-013D1								
FL205D1	Z(ZM)-UCFL205-014D1	C(CM)-UCFL205-014D1								
FL205D1	Z(ZM)-UCFL205-015D1	C(CM)-UCFL205-015D1	5/64	1 19/32	2	2 29/32	1 11/32	1.3	1.3	1.8
FL205D1	Z(ZM)-UCFL205-100D1	C(CM)-UCFL205-100D1								
FL206D1	Z(ZM)-UCFL206D1	C(CM)-UCFL206D1	2	45	56	85	40	0.9	0.9	1.2
FL206D1	Z(ZM)-UCFL206-101D1	C(CM)-UCFL206-101D1								
FL206D1	Z(ZM)-UCFL206-102D1	C(CM)-UCFL206-102D1								
FL206D1	Z(ZM)-UCFL206-103D1	C(CM)-UCFL206-103D1	5/64	1 3/4	2 7/32	3 11/32	1 3/16	2.0	2.0	2.6
FL206D1	—	C(CM)-UCFL206-104D1								
FL207D1	Z(ZM)-UCFL207D1	C(CM)-UCFL207D1	3	49	59	97	45	1.2	1.2	1.4
FL207D1	Z(ZM)-UCFL207-104D1	C(CM)-UCFL207-104D1								
FL207D1	Z(ZM)-UCFL207-105D1	C(CM)-UCFL207-105D1	1/8	1 15/16	2 5/16	3 13/16	1 25/32	2.6	2.6	3.1
FL207D1	Z(ZM)-UCFL207-106D1	C(CM)-UCFL207-106D1								
FL207D1	—	C(CM)-UCFL207-107D1								
FL208D1	Z(ZM)-UCFL208D1	C(CM)-UCFL208D1	3	56	66	106	50	1.5	1.5	1.9
FL208D1	Z(ZM)-UCFL208-108D1	C(CM)-UCFL208-108D1	1/8	2 3/16	2 19/32	4 3/16	1 31/32	3.3	3.3	4.2
FL208D1	Z(ZM)-UCFL208-109D1	C(CM)-UCFL208-109D1								

Rhombus flanged unit, cast housing Set screw type

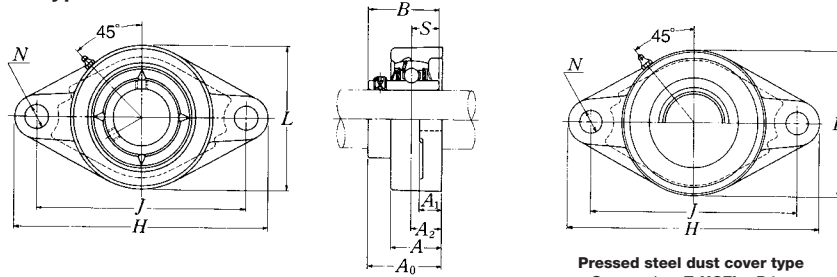

Pressed steel dust cover type
Open end **Z-UCFL...D1**
Closed end **ZM-UCFL...D1**

Shaft dia. mm inch	Unit number (1)	Nominal dimensions										Bolt size mm inch	Bearing number
		mm inch											
		H	J	A ₂	A ₁	A	N	L	A ₀	B	S		
45	UCFL209D1	188	148	22	16	38	19	108	52.2	49.2	19	M16	UC209D1
1 5/8	UCFL209-110D1												UC209-110D1
1 11/16	UCFL209-111D1	7 3/32	5 53/64	55/64	5/8	1 1/2	3/4	4 1/4	2 1/16	1.9370	0.748	5/8	UC209-111D1
1 3/4	UCFL209-112D1												UC209-112D1
50	UCFL210D1	197	157	22	16	40	19	115	54.6	51.6	19	M16	UC210D1
1 13/16	UCFL210-113D1												UC210-113D1
1 7/8	UCFL210-114D1	7 3/4	6 3/16	55/64	5/8	1 9/16	3/4	4 17/32	2 5/32	2.0315	0.748	5/8	UC210-114D1
1 15/16	UCFL210-115D1												UC210-115D1
2	UCFL210-200D1												UC210-200D1
55	UCFL211D1	224	184	25	18	43	19	130	58.4	55.6	22.2	M16	UC211D1
2	UCFL211-200D1												UC211-200D1
2 1/16	UCFL211-201D1	8 13/32	7 1/4	63/64	23/32	1 11/16	3/4	5 1/8	2 19/64	2.1890	0.874	5/8	UC211-201D1
2 1/8	UCFL211-202D1												UC211-202D1
2 13/16	UCFL211-203D1												UC211-203D1
60	UCFL212D1	250	202	29	18	48	23	140	68.7	65.1	25.4	M20	UC212D1
2 1/4	UCFL212-204D1												UC212-204D1
2 5/16	UCFL212-205D1	9 27/32	7 61/64	1 9/64	23/32	1 7/8	29/32	5 1/2	2 45/64	2.5630	1.000	3/4	UC212-205D1
2 3/8	UCFL212-206D1												UC212-206D1
2 7/16	UCFL212-207D1												UC212-207D1
65	UCFL213D1	258	210	30	22	50	23	155	69.7	65.1	25.4	M20	UC213D1
2 1/2	UCFL213-208D1	10 5/32	8 17/64	1 3/16	7/8	1 31/32	29/32	6 3/32	2 3/4	2.5630	1.000	3/4	UC213-208D1
2 9/16	UCFL213-209D1												UC213-209D1
70	UCFL214D1	265	216	31	22	54	23	160	75.4	74.6	30.2	M20	UC214D1
2 5/8	UCFL214-210D1												UC214-210D1
2 11/16	UCFL214-211D1	10 7/16	8 1/2	1 7/32	7/8	2 1/8	29/32	6 5/16	2 31/32	2.9370	1.189	3/4	UC214-211D1
2 3/4	UCFL214-212D1												UC214-212D1

Note (1) These numbers indicate relubricatable type. If maintenance free type is needed, please order without suffix "D1".

Remarks Please refer to page A21 for size of grease fitting.

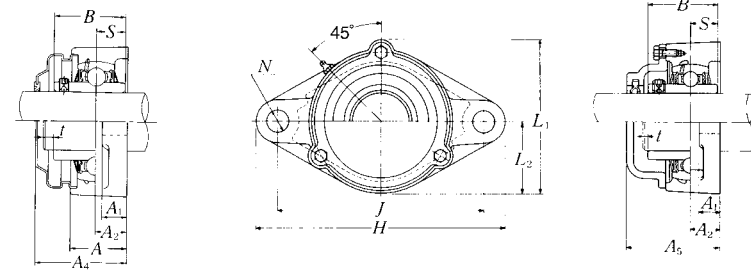

Cast dust cover type
Open end **C-UCFL...D1**
Closed end **CM-UCFL...D1**

Housing number	Unit number (1) pressed steel dust cover type	Unit number (1) cast dust cover type	Nominal dimensions					Mass of unit		
			mm inch					kg lb		
			t max.	A ₄	A ₅	L ₁	L ₂	UCFL	Z(ZM)	C(CM)
FL209D1	Z(ZM)-UCFL209D1	C(CM)-UCFL209D1	3	57	70	113	54	1.8	1.9	2.3
FL209D1	Z(ZM)-UCFL209-110D1	C(CM)-UCFL209-110D1								
FL209D1	Z(ZM)-UCFL209-111D1	C(CM)-UCFL209-111D1	1/8	2 1/4	2 3/4	4 7/16	2 1/8	4.0	4.2	5.1
FL209D1	Z(ZM)-UCFL209-112D1	C(CM)-UCFL209-112D1								
FL210D1	Z(ZM)-UCFL210D1	C(CM)-UCFL210D1	3	60	72	120	58	2.0	2.1	2.7
FL210D1	Z(ZM)-UCFL210-113D1	C(CM)-UCFL210-113D1								
FL210D1	Z(ZM)-UCFL210-114D1	C(CM)-UCFL210-114D1								
FL210D1	Z(ZM)-UCFL210-115D1	C(CM)-UCFL210-115D1	1/8	2 3/8	2 27/32	4 23/32	2 9/32	4.4	4.6	6.0
FL210D1	—	C(CM)-UCFL210-200D1								
FL211D1	Z(ZM)-UCFL211D1	C(CM)-UCFL211D1	4	64	75	133	65	2.9	3.0	3.4
FL211D1	Z(ZM)-UCFL211-200D1	C(CM)-UCFL211-200D1								
FL211D1	Z(ZM)-UCFL211-201D1	C(CM)-UCFL211-201D1								
FL211D1	Z(ZM)-UCFL211-202D1	C(CM)-UCFL211-202D1	5/32	2 1/2	2 15/16	5 1/4	2 9/16	6.4	6.6	7.5
FL211D1	Z(ZM)-UCFL211-203D1	C(CM)-UCFL211-203D1								
FL212D1	Z(ZM)-UCFL212D1	C(CM)-UCFL212D1	4	74	86	144	70	3.8	4.0	4.6
FL212D1	Z(ZM)-UCFL212-204D1	C(CM)-UCFL212-204D1								
FL212D1	Z(ZM)-UCFL212-205D1	C(CM)-UCFL212-205D1								
FL212D1	Z(ZM)-UCFL212-206D1	C(CM)-UCFL212-206D1	5/32	2 29/32	3 3/8	5 21/32	2 3/4	8.4	8.8	10
FL212D1	—	C(CM)-UCFL212-207D1								
FL213D1	Z(ZM)-UCFL213D1	C(CM)-UCFL213D1	4	76	90	157	78	4.8	4.9	5.8
FL213D1	Z(ZM)-UCFL213-208D1	C(CM)-UCFL213-208D1	5/32	3	3 17/32	6 3/16	3 1/16	11	11	13
FL213D1	Z(ZM)-UCFL213-209D1	C(CM)-UCFL213-209D1								
FL214D1	—	C(CM)-UCFL214D1	4	—	98	164	80	5.4	—	7.7
FL214D1		C(CM)-UCFL214-210D1								
FL214D1	—	C(CM)-UCFL214-211D1	5/32	—	3 27/32	6 15/32	3 5/32	12	—	17
FL214D1		C(CM)-UCFL214-212D1								

Rhombus flanged unit, cast housing Set screw type

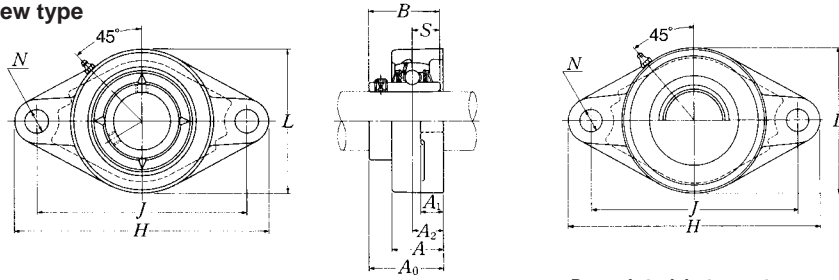

Pressed steel dust cover type
Open end **Z-UCFL...D1**
Closed end **ZM-UCFL...D1**

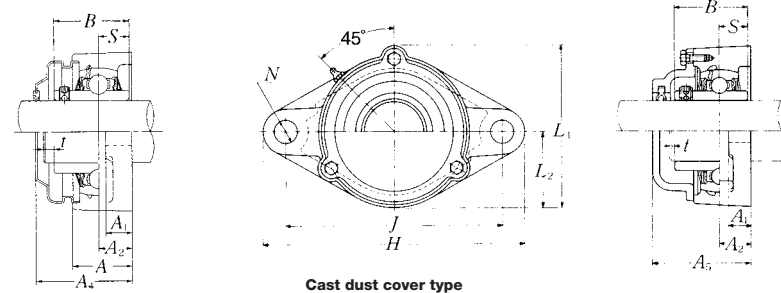

Cast dust cover type
Open end **C-UCFL...D1**
Closed end **CM-UCFL...D1**

Shaft dia. mm inch	Unit number (1)	Nominal dimensions										Bolt size mm inch	Bearing number
		mm inch											
		H	J	A ₂	A ₁	A	N	L	A ₀	B	S		
75	UCFL215D1	275	225	34	22	56	23	165	78.5	77.8	33.3	M20	UC215D1
2 ¹³ / ₁₆	UCFL215-213D1												UC215-213D1
2 ⁷ / ₈	UCFL215-214D1												UC215-214D1
2 ¹⁵ / ₁₆	UCFL215-215D1	10 ¹³ / ₁₆	8 ⁵⁵ / ₆₄	1 ¹¹ / ₃₂	7/8	2 ⁷ / ₃₂	29/32	6 ¹ / ₂	3 ³ / ₃₂	3.0630	1.311	3/4	UC215-215D1
3	UCFL215-300D1												UC215-300D1
80	UCFL216D1	290	233	34	22	58	25	180	83.3	82.6	33.3	M22	UC216D1
3 ¹ / ₁₆	UCFL216-301D1												UC216-301D1
3 ¹ / ₈	UCFL216-302D1	11 ¹³ / ₃₂	9 ¹¹ / ₆₄	1 ¹¹ / ₃₂	7/8	2 ⁹ / ₃₂	63/64	7 ³ / ₃₂	3 ⁹ / ₃₂	3.2520	1.311	7/8	UC216-302D1
3 ³ / ₁₆	UCFL216-303D1												UC216-303D1
85	UCFL217D1	305	248	36	24	63	25	190	87.6	85.7	34.1	M22	UC217D1
3 ¹ / ₄	UCFL217-304D1												UC217-304D1
3 ⁵ / ₁₆	UCFL217-305D1	12	9 ¹⁹ / ₆₄	1 ²⁷ / ₆₄	15/16	2 ¹⁵ / ₃₂	63/64	7 ¹⁵ / ₃₂	3 ²⁹ / ₆₄	3.3740	1.343	7/8	UC217-305D1
3 ⁷ / ₁₆	UCFL217-307D1												UC217-307D1
90	UCFL218D1	320	265	40	24	68	25	205	96.3	96	39.7	M22	UC218D1
3 ¹ / ₂	UCFL218-308D1	12 ¹⁹ / ₃₂	10 ⁷ / ₁₆	1 ³⁷ / ₆₄	15/16	2 ¹¹ / ₁₆	63/64	8 ¹ / ₁₆	3 ⁵¹ / ₆₄	3.7795	1.563	7/8	UC218-308D1

Note (1) These numbers indicate relubricatable type. If maintenance free type is needed, please order without suffix "D1".

Remarks Please refer to page A21 for size of grease fitting.

Housing number	Unit number pressed steel dust cover type	Unit number (1) cast dust cover type	Nominal dimensions					Mass of unit		
			mm inch					kg lb		
			t max.	A ₄	A ₅	L ₁	L ₂	UCFL	Z(ZM)	C(CM)
FL215D1	—	C(CM)-UCFL215D1	4	—	102	169	82	6.0	—	7.1
FL215D1	—	C(CM)-UCFL215-213D1								
FL215D1	—	C(CM)-UCFL215-214D1								
FL215D1	—	C(CM)-UCFL215-215D1	5 ⁵ / ₃₂	—	4 ¹ / ₃₂	6 ²¹ / ₃₂	3 ⁷ / ₃₂	13	—	16
FL215D1	—	C(CM)-UCFL215-300D1								
FL216D1	—	C(CM)-UCFL216D1	4	—	106	183	90	7.4	—	8.6
FL216D1	—	C(CM)-UCFL216-301D1								
FL216D1	—	C(CM)-UCFL216-302D1	5 ⁵ / ₃₂	—	4 ³ / ₁₆	7 ⁷ / ₃₂	3 ¹⁷ / ₃₂	16	—	19
FL216D1	—	C(CM)-UCFL216-303D1								
FL217D1	—	C(CM)-UCFL217D1	5	—	114	192	95	8.8	—	10
FL217D1	—	C(CM)-UCFL217-304D1								
FL217D1	—	C(CM)-UCFL217-305D1	13/64	—	4 ¹ / ₂	7 ⁹ / ₁₆	3 ³ / ₄	19	—	22
FL217D1	—	C(CM)-UCFL217-307D1								
FL218D1	—	C(CM)-UCFL218D1	5	—	122	205	102	11	—	13
FL218D1	—	C(CM)-UCFL218-308D1	13/64	—	4 ¹³ / ₁₆	8 ¹ / ₁₆	4 ¹ / ₃₂	24	—	29

Rhombus flanged unit, cast housing Set screw type

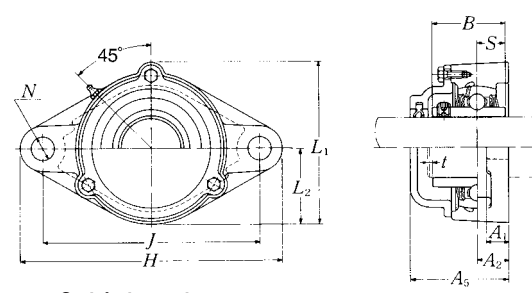
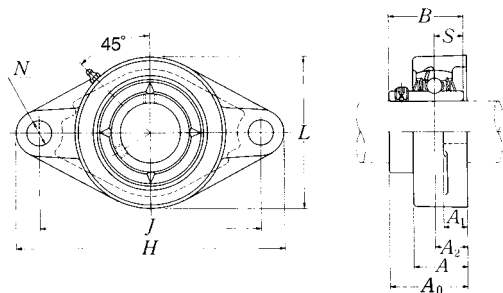

Cast dust cover type
Open end **C-UCFL...D1**
Closed end **CM-UCFL...D1**

Shaft dia. mm inch	Unit number (1)	Nominal dimensions										Bolt size mm inch
		mm inch										
		H	J	A ₂	A ₁	A	N	L	A ₀	B	S	
25	UCFL305D1	150	113	16	13	29	19	80	39	38	15	M16
$1\frac{3}{16}$	UCFL305-013D1											
$\frac{7}{8}$	UCFL305-014D1	$5\frac{29}{32}$	$4\frac{29}{64}$	$\frac{5}{8}$	$\frac{1}{2}$	$1\frac{5}{32}$	$\frac{3}{4}$	$3\frac{5}{32}$	$1\frac{17}{32}$	1.4961	0.591	$\frac{5}{8}$
$1\frac{15}{16}$	UCFL305-015D1											
1	UCFL305-100D1											
30	UCFL306D1	180	134	18	15	32	23	90	44	43	17	M20
$1\frac{1}{16}$	UCFL306-101D1											
$1\frac{1}{8}$	UCFL306-102D1	$7\frac{7}{32}$	$5\frac{9}{32}$	$\frac{45}{64}$	$\frac{19}{32}$	$1\frac{1}{4}$	$\frac{29}{32}$	$3\frac{17}{32}$	$1\frac{47}{64}$	1.6929	0.669	$\frac{3}{4}$
$1\frac{3}{16}$	UCFL306-103D1											
35	UCFL307D1	185	141	20	16	36	23	100	49	48	19	M20
$1\frac{1}{4}$	UCFL307-104D1											
$1\frac{5}{16}$	UCFL307-105D1	$7\frac{9}{32}$	$5\frac{35}{64}$	$\frac{25}{32}$	$\frac{5}{8}$	$1\frac{13}{32}$	$\frac{29}{32}$	$3\frac{15}{16}$	$1\frac{59}{64}$	1.8898	0.748	$\frac{3}{4}$
$1\frac{3}{8}$	UCFL307-106D1											
$1\frac{7}{16}$	UCFL307-107D1											
40	UCFL308D1	200	158	23	17	40	23	112	56	52	19	M20
$1\frac{1}{2}$	UCFL308-108D1	$7\frac{7}{8}$	$6\frac{7}{32}$	$\frac{29}{32}$	$\frac{21}{32}$	$1\frac{9}{16}$	$\frac{29}{32}$	$4\frac{13}{32}$	$2\frac{13}{64}$	2.0472	0.748	$\frac{3}{4}$
$1\frac{9}{16}$	UCFL308-109D1											
45	UCFL309D1	230	177	25	18	44	25	125	60	57	22	M22
$1\frac{5}{8}$	UCFL309-110D1											
$1\frac{11}{16}$	UCFL309-111D1	$9\frac{1}{16}$	$6\frac{31}{32}$	$\frac{63}{64}$	$\frac{23}{32}$	$1\frac{23}{32}$	$\frac{63}{64}$	$4\frac{29}{32}$	$2\frac{23}{64}$	2.2441	0.866	$\frac{7}{8}$
$1\frac{3}{4}$	UCFL309-112D1											
50	UCFL310D1	240	187	28	19	48	25	140	67	61	22	M22
$1\frac{13}{16}$	UCFL310-113D1											
$1\frac{7}{8}$	UCFL310-114D1	$9\frac{7}{16}$	$7\frac{23}{64}$	$1\frac{7}{64}$	$\frac{3}{4}$	$1\frac{7}{8}$	$\frac{63}{64}$	$5\frac{1}{2}$	$2\frac{41}{64}$	2.4016	0.866	$\frac{7}{8}$
$1\frac{15}{16}$	UCFL310-115D1											

Note (1) These numbers indicate relubricatable type. If maintenance free type is needed, please order without suffix "D1".
Remarks Please refer to page A21 for size of grease fitting.

Bearing number	Housing number	Unit number (1) cast dust cover type	Nominal dimensions				Mass of unit	
			mm inch				kg lb	
			t max.	A ₅	L ₁	L ₂	UCFL	C(CM)
UC305D1	FL305D1	C(CM)-UCFL305D1	2	56	86	40	0.9	1.2
UC305-013D1	FL305D1	C(CM)-UCFL305-013D1						
UC305-014D1	FL305D1	C(CM)-UCFL305-014D1	$\frac{5}{64}$	$2\frac{7}{32}$	$3\frac{3}{8}$	$1\frac{9}{16}$	2.0	2.6
UC305-015D1	FL305D1	C(CM)-UCFL305-015D1						
UC305-100D1	FL305D1	C(CM)-UCFL305-100D1						
UC306D1	FL306D1	C(CM)-UCFL306D1	2	60	101	45	1.4	1.7
UC306-101D1	FL306D1	C(CM)-UCFL306-101D1						
UC306-102D1	FL306D1	C(CM)-UCFL306-102D1	$\frac{5}{64}$	$2\frac{3}{8}$	$3\frac{31}{32}$	$1\frac{25}{32}$	3.1	3.7
UC306-103D1	FL306D1	C(CM)-UCFL306-103D1						
UC307D1	FL307D1	C(CM)-UCFL307D1	3	68	110	50	1.7	2.1
UC307-104D1	FL307D1	C(CM)-UCFL307-104D1						
UC307-105D1	FL307D1	C(CM)-UCFL307-105D1	$\frac{1}{8}$	$2\frac{11}{16}$	$4\frac{11}{32}$	$1\frac{31}{32}$	3.7	4.6
UC307-106D1	FL307D1	C(CM)-UCFL307-106D1						
UC307-107D1	FL307D1	C(CM)-UCFL307-107D1						
UC308D1	FL308D1	C(CM)-UCFL308D1	3	76	122	56	2.2	2.9
UC308-108D1	FL308D1	C(CM)-UCFL308-108D1	$\frac{1}{8}$	3	$4\frac{13}{16}$	$2\frac{7}{32}$	4.9	6.4
UC308-109D1	FL308D1	C(CM)-UCFL308-109D1						
UC309D1	FL309D1	C(CM)-UCFL309D1	3	80	135	62	3.0	3.8
UC309-110D1	FL309D1	C(CM)-UCFL309-110D1						
UC309-111D1	FL309D1	C(CM)-UCFL309-111D1	$\frac{1}{8}$	$3\frac{5}{32}$	$5\frac{5}{16}$	$2\frac{7}{16}$	6.6	8.4
UC309-112D1	FL309D1	C(CM)-UCFL309-112D1						
UC310D1	FL310D1	C(CM)-UCFL310D1	3	88	152	70	4.1	5.0
UC310-113D1	FL310D1	C(CM)-UCFL310-113D1						
UC310-114D1	FL310D1	C(CM)-UCFL310-114D1	$\frac{1}{8}$	$3\frac{15}{32}$	$5\frac{31}{32}$	$2\frac{3}{4}$	9.0	11
UC310-115D1	FL310D1	C(CM)-UCFL310-115D1						

Rhombus flanged unit, cast housing Set screw type

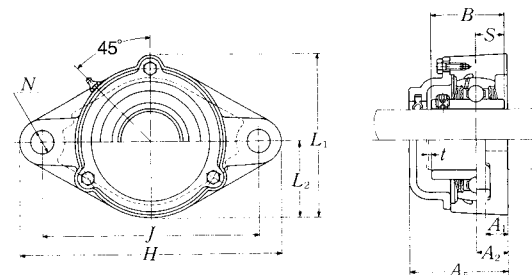
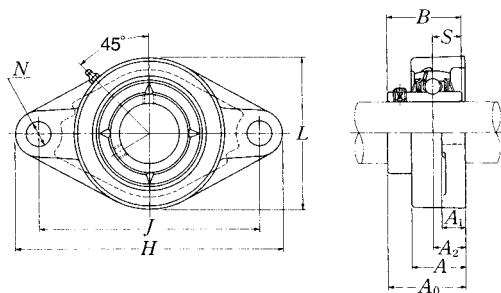

Cast dust cover type
Open end **C-UCFL...D1**
Closed end **CM-UCFL...D1**

Shaft dia. mm inch	Unit number (1)	Nominal dimensions										Bolt size mm inch
		mm inch										
		H	J	A ₂	A ₁	A	N	L	A ₀	B	S	
55	UCFL311D1	250	198	30	20	52	25	150	71	66	25	M22
2	UCFL311-200D1											
2 1/16	UCFL311-201D1	9 27/32	7 5/64	1 3/16	25/32	2 1/16	63/64	5 29/32	2 51/64	2.5984	0.984	7/8
2 1/8	UCFL311-202D1											
2 3/16	UCFL311-203D1											
60	UCFL312D1	270	212	33	22	56	31	160	78	71	26	M27
2 1/4	UCFL312-204D1											
2 5/16	UCFL312-205D1	10 5/8	8 1/32	1 19/64	7/8	2 7/32	1 7/32	6 5/16	3 5/64	2.7953	1.024	1
2 3/8	UCFL312-206D1											
2 7/16	UCFL312-207D1											
65	UCFL313D1	295	240	33	25	58	31	175	78	75	30	M27
2 1/2	UCFL313-208D1											
2 9/16	UCFL313-209D1	11 5/8	9 29/64	1 19/64	31/32	2 9/32	1 7/32	6 7/8	3 5/64	2.9528	1.181	1
70	UCFL314D1	315	250	36	28	61	35	185	81	78	33	M30
2 5/8	UCFL314-210D1											
2 11/16	UCFL314-211D1	12 13/32	9 27/32	1 27/64	1 3/32	2 13/32	1 3/8	7 9/32	3 3/16	3.0709	1.299	1 1/8
2 3/4	UCFL314-212D1											
75	UCFL315D1	320	260	39	30	66	35	195	89	82	32	M30
2 13/16	UCFL315-213D1											
2 7/8	UCFL315-214D1	12 19/32	10 15/64	1 17/32	1 3/16	2 19/32	1 3/8	7 11/16	3 1/2	3.2283	1.260	1 1/8
2 15/16	UCFL315-215D1											
3	UCFL315-300D1											
80	UCFL316D1	355	285	38	32	68	38	210	90	86	34	M33
3 1/16	UCFL316-301D1											
3 1/8	UCFL316-302D1	13 31/32	11 7/32	1 1/2	1 1/4	2 11/16	1 1/2	8 9/32	3 35/64	3.3858	1.339	1 1/4
3 3/16	UCFL316-303D1											

Note (1) These numbers indicate relubricatable type. If maintenance free type is needed, please order without suffix "D1".

Remarks Please refer to page A21 for size of grease fitting.

Bearing number	Housing number	Unit number (1) cast dust cover type	Nominal dimensions				Mass of unit	
			mm inch				kg lb	
			t max.	A ₅	L ₁	L ₂	UCFL	C(CM)
UC311D1	FL311D1	C(CM)-UCFL311D1	4	92	162	75	4.6	5.9
UC311-200D1	FL311D1	C(CM)-UCFL311-200D1						
UC311-201D1	FL311D1	C(CM)-UCFL311-201D1	5/32	3 5/8	6 3/8	2 15/16	10	13
UC311-202D1	FL311D1	C(CM)-UCFL311-202D1						
UC311-203D1	FL311D1	C(CM)-UCFL311-203D1						
UC312D1	FL312D1	C(CM)-UCFL312D1	4	100	175	80	5.7	7.7
UC312-204D1	FL312D1	C(CM)-UCFL312-204D1						
UC312-205D1	FL312D1	C(CM)-UCFL312-205D1	5/32	3 15/16	6 7/8	3 5/32	13	17
UC312-206D1	FL312D1	C(CM)-UCFL312-206D1						
UC312-207D1	FL312D1	C(CM)-UCFL312-207D1						
UC313D1	FL313D1	C(CM)-UCFL313D1	4	103	189	88	7.6	9.9
UC313-208D1	FL313D1	C(CM)-UCFL313-208D1	5/32	4 1/16	7 7/16	3 15/32	17	22
UC313-209D1	FL313D1	C(CM)-UCFL313-209D1						
UC314D1	FL314D1	C(CM)-UCFL314D1	4	106	198	92	8.6	11
UC314-210D1	FL314D1	C(CM)-UCFL314-210D1						
UC314-211D1	FL314D1	C(CM)-UCFL314-211D1	5/32	4 3/16	7 25/32	3 5/8	19	24
UC314-212D1	FL314D1	C(CM)-UCFL314-212D1						
UC315D1	FL315D1	C(CM)-UCFL315D1	4	114	210	98	9.9	12
UC315-213D1	FL315D1	C(CM)-UCFL315-213D1						
UC315-214D1	FL315D1	C(CM)-UCFL315-214D1	5/32	4 1/2	8 9/32	3 27/32	22	26
UC315-215D1	FL315D1	C(CM)-UCFL315-215D1						
UC315-300D1	FL315D1	C(CM)-UCFL315-300D1						
UC316D1	FL316D1	C(CM)-UCFL316D1	4	116	222	105	13	16
UC316-301D1	FL316D1	C(CM)-UCFL316-301D1						
UC316-302D1	FL316D1	C(CM)-UCFL316-302D1	5/32	4 9/16	8 3/4	4 1/8	29	35
UC316-303D1	FL316D1	C(CM)-UCFL316-303D1						

Rhombus flanged unit, cast housing Set screw type

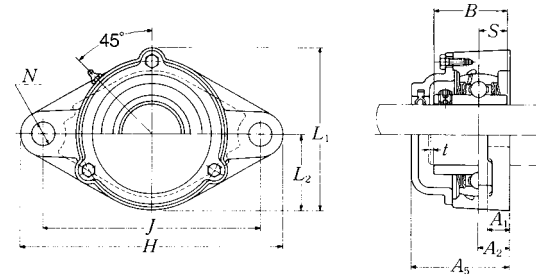
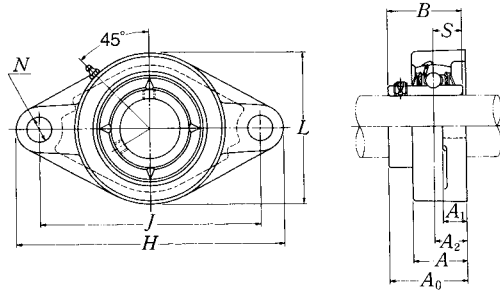

Cast dust cover type
Open end **C-UCFL...D1**
Closed end **CM-UCFL...D1**

Shaft dia. mm inch	Unit number (1)	Nominal dimensions										Bolt size mm inch
		mm inch										
		H	J	A ₂	A ₁	A	N	L	A ₀	B	S	
85 3 1/4	UCFL317D1 UCFL317-304D1	370	300	44	32	74	38	220	100	96	40	M33
3 5/16 3 7/16	UCFL317-305D1 UCFL317-307D1	14 9/16	11 13/16	1 47/64	1 1/4	2 29/32	1 1/2	8 21/32	3 15/16	3.7795	1.575	1 1/4
90 3 7/16 3 1/2	UCFL318D1 UCFL318-307D1 UCFL318-308D1	385	315	44	36	76	38	235	100	96	40	M33
3 7/16 3 1/2	UCFL318-307D1 UCFL318-308D1	15 5/32	12 13/32	1 47/64	1 13/32	3	1 1/2	9 1/4	3 15/16	3.7795	1.575	1 1/4
95 3 5/8 3 11/16 3 3/4	UCFL319D1 UCFL319-310D1 UCFL319-311D1 UCFL319-312D1	405	330	59	40	94	41	250	121	103	41	M36
3 5/8 3 11/16 3 3/4	UCFL319-310D1 UCFL319-311D1 UCFL319-312D1	15 15/16	12 83/64	2 21/64	1 9/16	3 11/16	1 39/64	9 27/32	4 49/64	4.0551	1.614	1 3/8
100 3 13/16 3 7/8 3 15/16 4	UCFL320D1 UCFL320-313D1 UCFL320-314D1 UCFL320-315D1 UCFL320-400D1	440	360	59	40	94	44	270	125	108	42	M39
3 13/16 3 7/8 3 15/16 4	UCFL320-313D1 UCFL320-314D1 UCFL320-315D1 UCFL320-400D1	17 5/16	14 11/64	2 21/64	1 9/16	3 11/16	1 47/64	10 5/8	4 59/64	4.2520	1.654	1 1/2
105	UCFL321D1	440	360	59	40	94	44	270	127	112	44	M39
110	UCFL322D1	470	390	60	42	96	44	300	131	117	46	M39
120	UCFL324D1	520	430	65	48	110	47	330	140	126	51	M42
130	UCFL326D1	550	460	65	50	115	47	360	146	135	54	M42
140	UCFL328D1	600	500	75	60	125	51	400	161	145	59	M45

Note (1) These numbers indicate relubricatable type. If maintenance free type is needed, please order without suffix "D1".

Remarks Please refer to page A21 for size of grease fitting.

Bearing number	Housing number	Unit number (1) cast dust cover type	Nominal dimensions				Mass of unit	
			mm inch				kg lb	
			t max.	A ₅	L ₁	L ₂	UCFL	C(CM)
UC317D1	FL317D1	C(CM)-UCFL317D1	5	127	234	110	15	18
UC317-304D1	FL317D1	C(CM)-UCFL317-304D1						
UC317-305D1	FL317D1	C(CM)-UCFL317-305D1	13/64	5	9 7/32	4 11/32	33	40
UC317-307D1	FL317D1	C(CM)-UCFL317-307D1						
UC318D1	FL318D1	C(CM)-UCFL318D1	5	129	247	118	17	21
UC318-307D1	FL318D1	C(CM)-UCFL318-307D1						
UC318-308D1	FL318D1	C(CM)-UCFL318-308D1	13/64	5 3/32	9 23/32	4 21/32	37	46
UC319D1	FL319D1	C(CM)-UCFL319D1	5	149	260	125	22	26
UC319-310D1	FL319D1	C(CM)-UCFL319-310D1						
UC319-311D1	FL319D1	C(CM)-UCFL319-311D1	13/64	5 7/8	10 1/4	4 29/32	49	57
UC319-312D1	FL319D1	C(CM)-UCFL319-312D1						
UC320D1	FL320D1	C(CM)-UCFL320D1	5	154	280	135	26	31
UC320-313D1	FL320D1	C(CM)-UCFL320-313D1						
UC320-314D1	FL320D1	C(CM)-UCFL320-314D1						
UC320-315D1	FL320D1	C(CM)-UCFL320-315D1	13/64	6 1/16	11 1/32	5 5/16	57	68
UC320-400D1	FL320D1	C(CM)-UCFL320-400D1						
UC321D1	FL321D1	C(CM)-UCFL321D1	5	156	287	135	27	32
UC322D1	FL322D1	C(CM)-UCFL322D1	5	160	315	150	34	39
UC324D1	FL324D1	C(CM)-UCFL324D1	5	172	342	165	48	52
UC326D1	FL326D1	C(CM)-UCFL326D1	6	178	376	180	58	64
UC328D1	FL328D1	C(CM)-UCFL328D1	6	192	410	200	81	90

Rhombus flanged unit, cast housing Set screw type

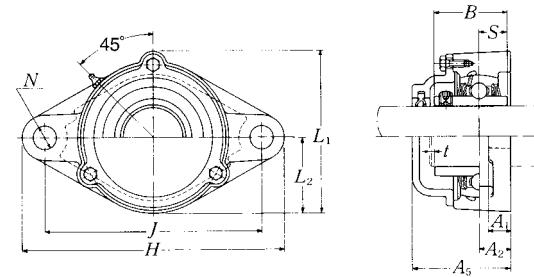
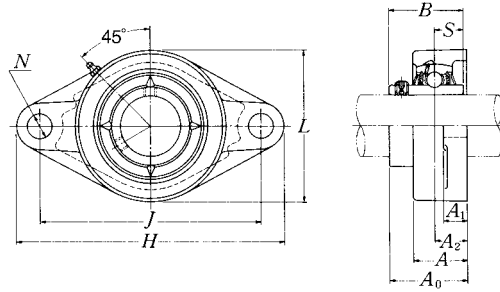

Cast dust cover type
Open end **C-UCFL...D1**
Closed end **CM-UCFL...D1**

Shaft dia. mm inch	Unit number (1)	Nominal dimensions										Bolt size mm inch
		mm inch										
		H	J	A ₂	A ₁	A	N	L	A ₀	B	S	
25	UCFLX05D1	141	117	18	13	30	12	83	40.2	38.1	15.9	M10
$1\frac{3}{16}$	UCFLX05-013D1											
$\frac{7}{8}$	UCFLX05-014D1											
$1\frac{5}{16}$	UCFLX05-015D1	$5\frac{9}{16}$	$4\frac{39}{64}$	$\frac{45}{64}$	$\frac{1}{2}$	$1\frac{3}{16}$	$\frac{15}{32}$	$3\frac{9}{32}$	$1\frac{37}{64}$	1.5000	0.626	$\frac{3}{8}$
1	UCFLX05-100D1											
30	UCFLX06D1	156	130	19	15	34	16	95	44.4	42.9	17.5	M14
$1\frac{1}{16}$	UCFLX06-101D1											
$1\frac{1}{8}$	UCFLX06-102D1											
$1\frac{3}{16}$	UCFLX06-103D1	$6\frac{5}{32}$	$5\frac{1}{8}$	$\frac{3}{4}$	$\frac{19}{32}$	$1\frac{11}{32}$	$\frac{5}{8}$	$3\frac{3}{4}$	$1\frac{3}{4}$	1.6890	0.689	$\frac{1}{2}$
$1\frac{1}{4}$	UCFLX06-104D1											
35	UCFLX07D1	171	144	21	16	38	16	105	51.2	49.2	19	M14
$1\frac{5}{16}$	UCFLX07-105D1											
$1\frac{3}{8}$	UCFLX07-106D1	$6\frac{23}{32}$	$5\frac{43}{64}$	$\frac{53}{64}$	$\frac{5}{8}$	$1\frac{1}{2}$	$\frac{5}{8}$	$4\frac{1}{8}$	$2\frac{1}{64}$	1.9370	0.748	$\frac{1}{2}$
$1\frac{7}{16}$	UCFLX07-107D1											
40	UCFLX08D1	179	148	22	16	40	16	111	52.2	49.2	19	M14
$1\frac{1}{2}$	UCFLX08-108D1											
$1\frac{9}{16}$	UCFLX08-109D1	$7\frac{1}{16}$	$5\frac{53}{64}$	$\frac{55}{64}$	$\frac{5}{8}$	$1\frac{9}{16}$	$\frac{5}{8}$	$4\frac{3}{8}$	$2\frac{1}{16}$	1.9370	0.748	$\frac{1}{2}$
45	UCFLX09D1	189	157	23	16	40	16	116	55.6	51.6	19	M14
$1\frac{5}{8}$	UCFLX09-110D1											
$1\frac{11}{16}$	UCFLX09-111D1											
$1\frac{3}{4}$	UCFLX09-112D1	$7\frac{7}{16}$	$6\frac{3}{16}$	$\frac{29}{32}$	$\frac{5}{8}$	$1\frac{9}{16}$	$\frac{5}{8}$	$4\frac{9}{16}$	$2\frac{3}{16}$	2.0315	0.748	$\frac{1}{2}$
$1\frac{13}{16}$	UCFLX09-113D1											
50	UCFLX10D1	216	184	26	18	44	19	133	59.4	55.6	22.2	M16
$1\frac{7}{8}$	UCFLX10-114D1											
$1\frac{15}{16}$	UCFLX10-115D1	$8\frac{1}{2}$	$7\frac{1}{4}$	$1\frac{1}{32}$	$\frac{23}{32}$	$1\frac{23}{32}$	$\frac{3}{4}$	$5\frac{1}{4}$	$2\frac{11}{32}$	2.1890	0.874	$\frac{5}{8}$
2	UCFLX10-200D1											

Note (1) These numbers indicate relubricatable type. If maintenance free type is needed, please order without suffix "D1".

Remarks Please refer to page A21 for size of grease fitting.

Bearing number	Housing number	Unit number (1) cast dust cover type	Nominal dimensions				Mass of unit	
			mm inch				kg lb	
			t max.	A ₅	L ₁	L ₂	UCFL	C(CM)
UCX05D1	FLX05D1	C(CM)-UCFLX05D1	2	56	86	41.5	1.0	1.2
UCX05-013D1	FLX05D1	C(CM)-UCFLX05-013D1						
UCX05-014D1	FLX05D1	C(CM)-UCFLX05-014D1						
UCX05-015D1	FLX05D1	C(CM)-UCFLX05-015D1	$\frac{5}{64}$	$2\frac{7}{32}$	$3\frac{3}{8}$	$1\frac{5}{8}$	2.2	2.6
UCX05-100D1	FLX05D1	C(CM)-UCFLX05-100D1						
UCX06D1	FLX06D1	C(CM)-UCFLX06D1	2	59	98.5	47.5	1.5	1.8
UCX06-101D1	FLX06D1	C(CM)-UCFLX06-101D1						
UCX06-102D1	FLX06D1	C(CM)-UCFLX06-102D1						
UCX06-103D1	FLX06D1	C(CM)-UCFLX06-103D1	$\frac{5}{64}$	$2\frac{5}{16}$	$3\frac{7}{8}$	$1\frac{7}{8}$	3.3	4.0
UC207-104D1	FLX06D1	C(CM)-UCFLX06-104D1						
UCX07D1	FLX07D1	C(CM)-UCFLX07D1	3	66	108.5	52.5	1.8	2.2
UCX07-105D1	FLX07D1	C(CM)-UCFLX07-105D1						
UCX07-106D1	FLX07D1	C(CM)-UCFLX07-106D1	$\frac{1}{8}$	$2\frac{19}{32}$	$4\frac{9}{32}$	$2\frac{1}{16}$	4.0	4.9
UCX07-107D1	FLX07D1	C(CM)-UCFLX07-107D1						
UCX08D1	FLX08D1	C(CM)-UCFLX08D1	3	70	114.5	55.5	2.0	2.4
UCX08-108D1	FLX08D1	C(CM)-UCFLX08-108D1						
UCX08-109D1	FLX08D1	C(CM)-UCFLX08-109D1	$\frac{1}{8}$	$2\frac{3}{4}$	$4\frac{1}{4}$	$2\frac{3}{16}$	4.4	5.3
UCX09D1	FLX09D1	C(CM)-UCFLX09D1	3	73	119.5	58	2.2	2.7
UCX09-110D1	FLX09D1	C(CM)-UCFLX09-110D1						
UCX09-111D1	FLX09D1	C(CM)-UCFLX09-111D1						
UCX09-112D1	FLX09D1	C(CM)-UCFLX09-112D1	$\frac{1}{6}$	$2\frac{7}{6}$	$4\frac{23}{32}$	$2\frac{9}{32}$	4.9	6.0
UC210-113D1	FLX09D1	C(CM)-UCFLX09-113D1						
UCX10D1	FLX10D1	C(CM)-UCFLX10D1	3	76	133.5	66.5	3.0	3.6
UCX10-114D1	FLX10D1	C(CM)-UCFLX10-114D1						
UCX10-115D1	FLX10D1	C(CM)-UCFLX10-115D1	$\frac{1}{8}$	3	$5\frac{1}{4}$	$2\frac{5}{8}$	6.6	7.9
UC211-200D1	FLX10D1	C(CM)-UCFLX10-200D1						

Modified rhombus flanged unit, cast housing Set screw type

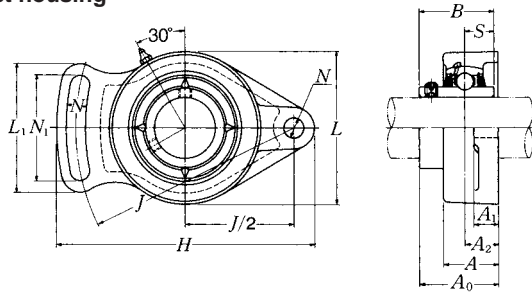

Shaft dia. mm inch	Unit number (1)	Nominal dimensions												Bolt size mm inch
		H	J	A ₂	A ₁	A	N	N ₁	L	L ₁	A ₀	B	S	
12	UCFA201D1	98	78	15	12	25.5	10	40	60	50	33.3	31	12.7	M8
1/2	UCFA201-008D1	3 ²⁷ / ₃₂	3 ¹ / ₁₆	19 ¹ / ₃₂	15 ¹ / ₃₂	1	25 ¹ / ₆₄	1 ⁹ / ₁₆	2 ³ / ₈	1 ³¹ / ₃₂	1 ⁵ / ₁₆	1.2205	0.500	5 ¹ / ₁₆
15	UCFA202D1	98	78	15	12	25.5	10	40	60	50	33.3	31	12.7	M8
9/16	UCFA202-009D1	3 ²⁷ / ₃₂	3 ¹ / ₁₆	19 ¹ / ₃₂	15 ¹ / ₃₂	1	25 ¹ / ₆₄	1 ⁹ / ₁₆	2 ³ / ₈	1 ³¹ / ₃₂	1 ⁵ / ₁₆	1.2205	0.500	5 ¹ / ₁₆
5/8	UCFA202-010D1	3 ²⁷ / ₃₂	3 ¹ / ₁₆	19 ¹ / ₃₂	15 ¹ / ₃₂	1	25 ¹ / ₆₄	1 ⁹ / ₁₆	2 ³ / ₈	1 ³¹ / ₃₂	1 ⁵ / ₁₆	1.2205	0.500	5 ¹ / ₁₆
17	UCFA203D1	98	78	15	12	25.5	10	40	60	50	33.3	31	12.7	M8
11/16	UCFA203-011D1	3 ²⁷ / ₃₂	3 ¹ / ₁₆	19 ¹ / ₃₂	15 ¹ / ₃₂	1	25 ¹ / ₆₄	1 ⁹ / ₁₆	2 ³ / ₈	1 ³¹ / ₃₂	1 ⁵ / ₁₆	1.2205	0.500	5 ¹ / ₁₆
20	UCFA204D1	98	78	15	12	25.5	10	40	60	50	33.3	31	12.7	M8
3/4	UCFA204-012D1	3 ²⁷ / ₃₂	3 ¹ / ₁₆	19 ¹ / ₃₂	15 ¹ / ₃₂	1	25 ¹ / ₆₄	1 ⁹ / ₁₆	2 ³ / ₈	1 ³¹ / ₃₂	1 ⁵ / ₁₆	1.2205	0.500	5 ¹ / ₁₆
25	UCFA205D1	124	96	15	14	26.5	13	49	70	64	34.8	34.1	14.3	M10
13/16	UCFA205-013D1													
7/8	UCFA205-014D1	4 ⁷ / ₈	3 ²⁵ / ₃₂	19 ¹ / ₃₂	9 ¹ / ₁₆	1 ¹ / ₃₂	33 ³ / ₆₄	1 ¹⁵ / ₁₆	2 ³ / ₄	2 ¹⁷ / ₃₂	1 ³ / ₈	1.3425	0.563	3 ¹ / ₈
15/16	UCFA205-015D1													
1	UCFA205-100D1													
30	UCFA206D1	141	115	18	14	31	13	53	80	68	40.2	38.1	15.9	M10
1 1/16	UCFA206-101D1													
1 1/8	UCFA206-102D1	5 ⁹ / ₁₆	4 ¹⁷ / ₃₂	45 ¹ / ₆₄	9 ¹ / ₁₆	1 ⁷ / ₃₂	33 ³ / ₆₄	2 ³ / ₃₂	3 ⁵ / ₃₂	2 ¹¹ / ₁₆	1 ³⁷ / ₆₄	1.5000	0.626	3 ¹ / ₈
1 3/16	UCFA206-103D1													
1 1/4	UCFA206-104D1													
35	UCFA207D1	155	128	20	16	34	15	60	90	75	45.4	42.9	17.5	M12
1 1/4	UCFA207-104D1													
1 5/16	UCFA207-105D1	6 ³ / ₃₂	5 ¹ / ₃₂	25 ¹ / ₃₂	5 ¹ / ₈	1 ¹¹ / ₃₂	19 ¹ / ₃₂	2 ³ / ₈	3 ¹⁷ / ₃₂	2 ¹⁵ / ₁₆	1 ²⁵ / ₃₂	1.6890	0.689	7 ¹ / ₁₆
1 3/8	UCFA207-106D1													
1 7/16	UCFA207-107D1													
40	UCFA208D1	171	142	22	16	36	15	69	100	84	52.2	49.2	19	M12
1 1/2	UCFA208-108D1	6 ²³ / ₃₂	5 ¹⁹ / ₃₂	55 ¹ / ₆₄	5 ¹ / ₈	1 ¹³ / ₃₂	19 ¹ / ₃₂	2 ²³ / ₃₂	3 ¹⁵ / ₁₆	3 ⁵ / ₁₆	2 ¹ / ₁₆	1.9370	0.748	7 ¹ / ₁₆
1 9/16	UCFA208-109D1													

Note (1) These numbers indicate relubricatable type. If maintenance free type is needed, please order without suffix "D1".

Remarks Please refer to page A21 for size of grease fitting.

Bearing number	Housing number	Mass of unit kg lb
UC201D1	FA204D1	0.5
UC201-008D1	FA204D1	1.1
UC202D1	FA204D1	0.5
UC202-009D1	FA204D1	1.1
UC202-010D1	FA204D1	1.1
UC203D1	FA204D1	0.5
UC203-011D1	FA204D1	1.1
UC204D1	FA204D1	0.5
UC204-012D1	FA204D1	1.1
UC205D1	FA205D1	0.7
UC205-013D1	FA205D1	
UC205-014D1	FA205D1	1.5
UC205-015D1	FA205D1	
UC205-100D1	FA205D1	
UC206D1	FA206D1	0.9
UC206-101D1	FA206D1	
UC206-102D1	FA206D1	2.0
UC206-103D1	FA206D1	
UC206-104D1	FA206D1	
UC207D1	FA207D1	1.2
UC207-104D1	FA207D1	
UC207-105D1	FA207D1	2.6
UC207-106D1	FA207D1	
UC207-107D1	FA207D1	
UC208D1	FA208D1	1.5
UC208-108D1	FA208D1	3.3
UC208-109D1	FA208D1	

Modified rhombus flanged unit, cast housing Set screw type

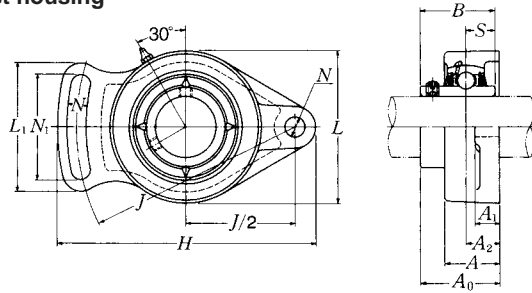

Shaft dia. mm inch	Unit number (1)	Nominal dimensions											Bolt size mm inch	
		mm inch												
		H	J	A ₂	A ₁	A	N	N ₁	L	L ₁	A ₀	B	S	
45 1 5/8	UCFA209D1	179	146	22	18	38	17	72	110	88	52.2	49.2	19	M14
1 11/16	UCFA209-110D1	7 1/16	5 3/4	55/64	23/32	1 1/2	43/64	2 27/32	4 11/32	3 15/32	2 1/16	1.9370	0.748	1/2
1 3/4	UCFA209-112D1													
50 1 13/16	UCFA210D1	189	155	22	18	40	17	75	115	92	54.6	51.6	19	M14
1 7/8	UCFA210-113D1	7 7/16	6 3/32	55/64	23/32	1 9/16	43/64	2 15/16	4 17/32	3 5/8	2 5/32	2.0315	0.748	1/2
1 15/16	UCFA210-114D1													
2	UCFA210-115D1													
2	UCFA210-200D1													
55 2	UCFA211D1	216	182	26	20	43	17	85	130	102	59.4	55.6	22.2	M14
2 1/16	UCFA211-200D1	8 1/8	7 5/32	1 1/32	25/32	1 1/16	43/64	3 11/32	5 1/8	4 1/32	2 11/32	2.1890	0.874	1/2
2 1/8	UCFA211-201D1													
2 3/8	UCFA211-202D1													
2 3/16	UCFA211-203D1													

Note (1) These numbers indicate relubricatable type. If maintenance free type is needed, please order without suffix "D1".

Remarks Please refer to page A21 for size of grease fitting.

Bearing number	Housing number	Mass of unit kg lb
UC209D1	FA209D1	1.9
UC209-110D1	FA209D1	4.2
UC209-111D1	FA209D1	4.2
UC209-112D1	FA209D1	4.2
UC210D1	FA210D1	2.2
UC210-113D1	FA210D1	4.9
UC210-114D1	FA210D1	4.9
UC210-115D1	FA210D1	4.9
UC210-200D1	FA210D1	4.9
UC211D1	FA211D1	2.9
UC211-200D1	FA211D1	6.4
UC211-201D1	FA211D1	6.4
UC211-202D1	FA211D1	6.4
UC211-203D1	FA211D1	6.4

Modified flanged unit, cast housing Set screw type

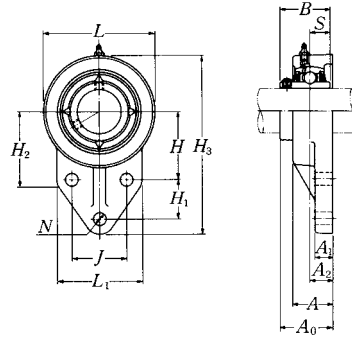

Shaft dia. mm inch	Unit number ⁽¹⁾	Nominal dimensions														
		mm inch														
		H ₃	J	A ₂	A ₁	A	N	H	H ₁	L ₁	H ₂	L	A ₀	B	S	
12 1/2	UCFH201D1 UCFH201-008D1	110 4 11/32	32 1 17/64	15 19/32	13 1/2	25.5 1	10 25/64	42 1 21/32	27 1 1/16	52 2 1/16	52 2 1/16	62 2 7/16	33.3 1 5/16	31 1.2205	12.7 0.500	
15 9/16 5/8	UCFH202D1 UCFH202-009D1 UCFH202-010D1	110 4 11/32	32 1 17/64	15 19/32	13 1/2	25.5 1	10 25/64	42 1 21/32	27 1 1/16	52 2 1/16	52 2 1/16	62 2 7/16	33.3 1 5/16	31 1.2205	12.7 0.500	
17 11/16	UCFH203D1 UCFH203-011D1	110 4 11/32	32 1 17/64	15 19/32	13 1/2	25.5 1	10 25/64	42 1 21/32	27 1 1/16	52 2 1/16	52 2 1/16	62 2 7/16	33.3 1 5/16	31 1.2205	12.7 0.500	
20 3/4	UCFH204D1 UCFH204-012D1	110 4 11/32	32 1 17/64	15 19/32	13 1/2	25.5 1	10 25/64	42 1 21/32	27 1 1/16	52 2 1/16	52 2 1/16	62 2 7/16	33.3 1 5/16	31 1.2205	12.7 0.500	
25 13/16 7/8 15/16	UCFH205D1 UCFH205-013D1 UCFH205-014D1 UCFH205-015D1	116 4 9/16	34 1 11/32	16 5/8	13 1/2	27 1 1/16	10 25/64	45 1 49/64	27 1 1/16	56 2 7/32	52 2 1/16	68 2 11/16	35.8 1 13/32	34.1 1.3425	14.3 0.563	
1 UCFH205-100D1																
30 1 1/16 1 1/8 1 3/16 1 1/4	UCFH206D1 UCFH206-101D1 UCFH206-102D1 UCFH206-103D1 UCFH206-104D1	130 5 1/8	40 1 37/64	18 45/64	13 1/2	31 1 7/32	10 25/64	50 1 31/32	29 1 9/64	65 2 9/16	55 2 5/32	78 3 1/16	40.2 1 37/64	38.1 1.5000	15.9 0.626	
35 1 1/4 1 5/16 1 3/8 1 7/16	UCFH207D1 UCFH207-104D1 UCFH207-105D1 UCFH207-106D1 UCFH207-107D1	144 5 21/32	46 1 13/16	19 3/4	15 19/32	34 1 11/32	10 25/64	55 2 1/64	32 1 17/64	70 2 3/4	62 2 7/16	90 3 17/32	44.4 1 3/4	42.9 1.6890	17.5 0.689	

Note ⁽¹⁾ These numbers indicate relubricatable type. If maintenance free type is needed, please order without suffix "D1".

Remarks Please refer to page A21 for size of grease fitting.

Bolt size mm inch	Bearing number	Housing number	Mass of unit kg lb
M8 5/16	UC201D1 UC201-008D1	FH204D1 FH204D1	0.6 1.3
M8 5/16	UC202D1 UC202-009D1 UC202-010D1	FH204D1 FH204D1 FH204D1	0.6 1.3
M8 5/16	UC203D1 UC203-011D1	FH204D1 FH204D1	0.6 1.3
M8 5/16	UC204D1 UC204-012D1	FH204D1 FH204D1	0.6 1.3
M8 5/16	UC205D1 UC205-013D1 UC205-014D1 UC205-015D1 UC205-100D1	FH205D1 FH205D1 FH205D1 FH205D1 FH205D1	0.7 1.5
M8 5/16	UC206D1 UC206-101D1 UC206-102D1 UC206-103D1 UC206-104D1	FH206D1 FH206D1 FH206D1 FH206D1 FH206D1	0.9 2.0
M8 5/16	UC207D1 UC207-104D1 UC207-105D1 UC207-106D1 UC207-107D1	FH207D1 FH207D1 FH207D1 FH207D1 FH207D1	1.3 2.9

Modified flanged unit, cast housing Set screw type

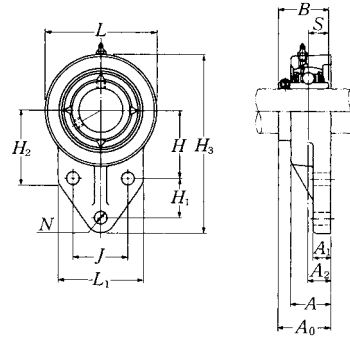

Shaft dia. mm inch	Unit number ⁽¹⁾	Nominal dimensions														
		mm inch														
		H_3	J	A_2	A_1	A	N	H	H_1	L_1	H_2	L	A_0	B	S	
40	UCFH208D1	164	50	21	16	36	12	60	41	78	72	100	51.2	49.2	19	
1 1/2	UCFH208-108D1	6 15/32	1 31/32	53/64	5/8	1 13/32	15/32	2 23/64	1 39/64	3 1/16	2 27/32	3 15/16	2 1/64	1.9370	0.748	
1 9/16	UCFH208-109D1															
45	UCFH209D1	174	54	22	18	38	12	65	43	80	76	106	52.2	49.2	19	
1 5/8	UCFH209-110D1															
1 1/16	UCFH209-111D1	6 27/32	2 1/8	55/64	23/32	1 1/2	15/32	2 9/16	1 11/16	3 5/32	3	4 3/16	2 1/16	1.9370	0.748	
1 3/4	UCFH209-112D1															
50	UCFH210D1	184	58	22	18	40	12	68	46	86	82	112	54.6	51.6	19	
1 13/16	UCFH210-113D1															
1 7/8	UCFH210-114D1	7 1/4	2 9/32	55/64	23/32	1 9/16	15/32	2 13/64	1 13/16	3 3/8	3 7/32	4 13/32	2 5/32	2.0315	0.748	
1 15/16	UCFH210-115D1															
2	UCFH210-200D1															

Note ⁽¹⁾ These numbers indicate relubricatable type. If maintenance free type is needed, please order without suffix "D1".

Remarks Please refer to page A21 for size of grease fitting.

Bolt size mm inch	Bearing number	Housing number	Mass of unit kg lb
M10	UC208D1	FH208D1	1.8
3/8	UC208-108D1	FH208D1	4.0
	UC208-109D1	FH208D1	
M10	UC209D1	FH209D1	2.1
	UC209-110D1	FH209D1	
3/8	UC209-111D1	FH209D1	4.6
	UC209-112D1	FH209D1	
M10	UC210D1	FH210D1	2.4
	UC210-113D1	FH210D1	
3/8	UC210-114D1	FH210D1	5.3
	UC210-115D1	FH210D1	
	UC210-200D1	FH210D1	

Light rhombus flanged unit, cast housing Set screw type

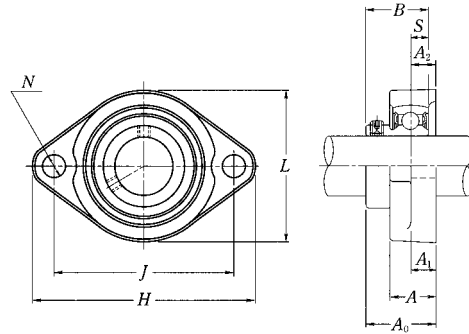

Shaft dia. mm inch	Unit number ⁽¹⁾	Nominal dimensions										Bolt size mm inch
		H	J	A ₂	A ₁	A	N	L	A ₀	B	S	
12 1/2	ASFB201 ASFB201-008	81 3 ^{3/16}	63.5 2 ^{1/2}	9.5 3/8	9.5 3/8	18 23/32	7 9/32	56 2 ^{7/32}	25.5 1	22 0.8661	6 0.236	M6 1/4
15 9/16 5/8	ASFB202 ASFB202-009 ASFB202-010	81 3 ^{3/16}	63.5 2 ^{1/2}	9.5 3/8	9.5 3/8	18 23/32	7 9/32	56 2 ^{7/32}	25.5 1	22 0.8661	6 0.236	M6 1/4
17 1/2	ASFB203 ASFB203-011	81 3 ^{3/16}	63.5 2 ^{1/2}	9.5 3/8	9.5 3/8	18 23/32	7 9/32	56 2 ^{7/32}	25.5 1	22 0.8661	6 0.236	M6 1/4
20 3/4	ASFB204 ASFB204-012	90 3 ^{17/32}	71.5 2 ^{13/16}	11 7/16	11 7/16	20 25/32	10 25/64	61 2 ^{13/32}	29 1 ^{9/64}	25 0.9843	7 0.276	M8 5/16
25 13/16 7/8 15/16 1	ASFB205 ASFB205-013 ASFB205-014 ASFB205-015 ASFB205-100	95 3 ^{3/4}	76 2 ^{63/64}	11 7/16	11 7/16	20 25/32	10 25/64	64 2 ^{17/32}	30.5 1 ^{13/64}	27 1.0630	7.5 0.295	M8 5/16
30 1 ^{1/16} 1 ^{1/8} 1 ^{3/16} 1 ^{1/4}	ASFB206 ASFB206-101 ASFB206-102 ASFB206-103 ASFB206-104	113 4 ^{7/16}	90.5 3 ^{9/16}	12 15/32	12 15/32	22.5 7/8	12 15/32	76 3	33 1 ^{19/64}	29 1.1417	8 0.315	M10 3/8
35 1 ^{1/4} 1 ^{5/16} 1 ^{3/8} 1 ^{7/16}	ASFB207 ASFB207-104 ASFB207-105 ASFB207-106 ASFB207-107	122 4 ^{13/16}	100 3 ^{15/16}	11 7/16	13 1/2	24 15/16	12 15/32	89 3 ^{1/2}	36.5 1 ^{7/16}	34 1.3386	8.5 0.335	M10 3/8

Note (1) If relubricatable type is needed, please order with suffix "D1".

Bearing number	Housing number	Mass of unit kg lb
AS201	FB201	0.3
AS201-008	FB201	0.7
AS202	FB201	0.3
AS202-009	FB201	0.7
AS202-010	FB201	0.7
AS203	FB201	0.2
AS203-011	FB201	0.4
AS204	FB204	0.3
AS204-012	FB204	0.7
AS205	FB205	0.3
AS205-013	FB205	0.7
AS205-014	FB205	0.7
AS205-015	FB205	0.7
AS205-100	FB205	0.7
AS206	FB206	0.5
AS206-101	FB206	1.1
AS206-102	FB206	1.1
AS206-103	FB206	1.1
AS206-104	FB206	1.1
AS207	FB207	0.8
AS207-104	FB207	1.8
AS207-105	FB207	1.8
AS207-106	FB207	1.8
AS207-107	FB207	1.8

Light rhombus flanged unit, cast housing Set screw type

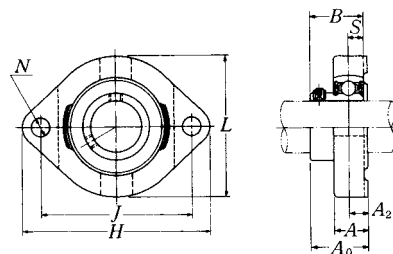

Shaft dia. mm inch	Unit number ⁽¹⁾	Nominal dimensions									Bolt size mm inch
		H	J	A ₂	A	N	L	A ₀	B	S	
12 1/2	ASFD201 ASFD201-008	81 3 3/16	63 2 31/64	8.5 21/64	15 19/32	7 9/32	59 2 5/16	24.5 31/32	22 0.8661	6 0.236	M6 1/4
15 9/16 5/8	ASFD202 ASFD202-009 ASFD202-010	81 3 3/16	63 2 31/64	8.5 21/64	15 19/32	7 9/32	59 2 5/16	24.5 31/32	22 0.8661	6 0.236	M6 1/4
17 11/16	ASFD203 ASFD203-011	81 3 3/16	63 2 31/64	8.5 21/64	15 19/32	7 9/32	59 2 5/16	24.5 31/32	22 0.8661	6 0.236	M6 1/4
20 3/4	ASFD204 ASFD204-012	90 3 17/32	71 2 51/64	9.5 3/8	17 21/32	10 25/64	67 2 5/8	27.5 1 5/64	25 0.9843	7 0.276	M8 5/16
25 13/16 7/8 15/16 1	ASFD205 ASFD205-013 ASFD205-014 ASFD205-015 ASFD205-100	95 3 3/4	76 2 63/64	9.5 3/8	17 21/32	10 25/64	71 2 25/32	29 1 9/64	27 1.0630	7.5 0.295	M8 5/16
30 1 1/16 1 1/8 1 3/16 1 1/4	ASFD206 ASFD206-101 ASFD206-102 ASFD206-103 ASFD206-104	113 4 7/16	90 3 35/64	12 15/32	21 13/16	12 15/32	84 3 5/16	33 1 19/64	29 1.1417	8 0.315	M10 3/8
35 1 1/4 1 5/16 1 3/8 1 7/16	ASFD207 ASFD207-104 ASFD207-105 ASFD207-106 ASFD207-107	125 4 29/32	100 3 15/16	12.5 31/64	22 7/8	12 15/32	94 3 11/16	38 1 1/2	34 1.3386	8.5 0.335	M10 3/8
40 1 1/2 1 9/16	ASFD208 ASFD208-108 ASFD208-109	148 5 13/16	119 4 11/16	14.5 37/64	25 31/32	13.5 17/32	104 4 3/32	43.5 1 23/32	38 1.4961	9 0.354	M12 9/16

Note (1) If relubricatable type is needed, please order with suffix "A-" "D1". Example: A-ASFD201D1

Bearing number	Housing number	Mass of unit kg lb
AS201	FD201	0.3
AS201-008	FD201	0.7
AS202	FD201	0.3
AS202-009	FD201	0.7
AS202-010	FD201	0.7
AS203	FD201	0.3
AS203-011	FD201	0.7
AS204	FD204	0.4
AS204-012	FD204	0.9
AS205	FD205	0.5
AS205-013	FD205	
AS205-014	FD205	1.1
AS205-015	FD205	
AS205-100	FD205	
AS206	FD206	0.8
AS206-101	FD206	
AS206-102	FD206	1.8
AS206-103	FD206	
AS206-104	FD206	
AS207	FD207	0.9
AS207-104	FD207	
AS207-105	FD207	2.0
AS207-106	FD207	
AS207-107	FD207	
AS208	FD208	1.3
AS208-108	FD208	2.9
AS208-109	FD208	

Round flanged unit, pressed steel housing Set screw type

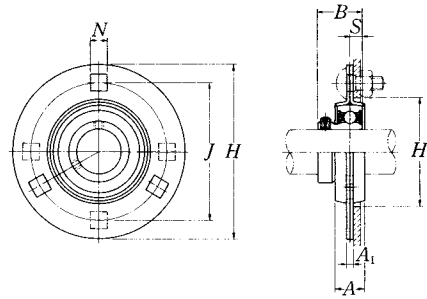

Shaft dia. mm inch	Unit number	Nominal dimensions								Bolt size mm inch
		H	J	A ₁	mm inch N ⁽¹⁾ A		B	S	H ₁ min.	
12 1/2	ASPF201 ASPF201-008	81 3 3/16	63.5 2 1/2	4 0.157	7.1 9/32	14 9/16	22 0.8661	6 0.236	49 1 15/16	M6 1/4
15 9/16 5/8	ASPF202 ASPF202-009 ASPF202-010	81 3 3/16	63.5 2 1/2	4 0.157	7.1 9/32	14 9/16	22 0.8661	6 0.236	49 1 15/16	M6 1/4
17 1 1/16	ASPF203 ASPF203-011	81 3 3/16	63.5 2 1/2	4 0.157	7.1 9/32	14 9/16	22 0.8661	6 0.236	49 1 15/16	M6 1/4
20 3/4	ASPF204 ASPF204-012	90 3 5/8	71.5 2 13/16	4 0.157	9 23/64	16 5/8	25 0.9843	7 0.276	56 2 7/32	M8 5/16
25 13/16 7/8 15/16 1	ASPF205 ASPF205-013 ASPF205-014 ASPF205-015 ASPF205-100	95 3 3/4	76 2 63/64	4 0.157	9 23/64	18 23/32	27 1.0630	7.5 0.295	60 2 3/8	M8 5/16
30 1 1/16 1 1/8 1 3/16 1 1/4	ASPF206 ASPF206-101 ASPF206-102 ASPF206-103 ASPF206-104	113 4 1/16	90.5 3 9/16	5.2 0.205	11 7/16	18 23/32	29 1.1417	8 0.315	71 2 13/16	M10 3/8
35 1 1/4 1 5/16 1 3/8 1 7/16	ASPF207 ASPF207-104 ASPF207-105 ASPF207-106 ASPF207-107	122 4 13/16	100 3 15/16	5.2 0.205	11 7/16	20 25/32	34 1.3386	8.5 0.335	81 3 3/16	M10 3/8
40 1 1/2 1 9/16	ASPF208 ASPF208-108 ASPF208-109	148 5 13/16	119 4 11/16	6.8 0.268	13.5 17/32	21 13/16	38 1.4961	9 0.354	91 3 19/32	M12 1/2

Notes (1) ASPF208 has four bolt holes.

(2) The permissible load only applies in applications where the load is stable and the speed is 2400 min⁻¹ or less.

Max. load ⁽²⁾ recommended		Bearing number	Housing number	Mass of unit kg lb
N lbf				
radial	axial			
2 700 600	1 350 300	AS201 AS201-008	PF203 PF203	0.2 0.4
2 700 600	1 350 300	AS202 AS202-009 AS202-010	PF203 PF203 PF203	0.2 0.4
2 700 600	1 350 300	AS203 AS203-011	PF203 PF203	0.2 0.4
3 000 660	1 500 330	AS204 AS204-012	PF204 PF204	0.2 0.4
4 000 880	2 000 440	AS205 AS205-013 AS205-014 AS205-015 AS205-100	PF205 PF205 PF205 PF205 PF205	0.3 0.7
5 000 1 100	2 500 550	AS206 AS206-101 AS206-102 AS206-103 AS206-104	PF206 PF206 PF206 PF206 PF206	0.4 0.9
6 000 1 300	3 000 650	AS207 AS207-104 AS207-105 AS207-106 AS207-107	PF207 PF207 PF207 PF207 PF207	0.6 1.3
7 000 1 500	3 500 750	AS208 AS208-108 AS208-109	PF208 PF208 PF208	0.9 2.0

Round flanged unit, pressed steel housing with rubber ring Set screw type

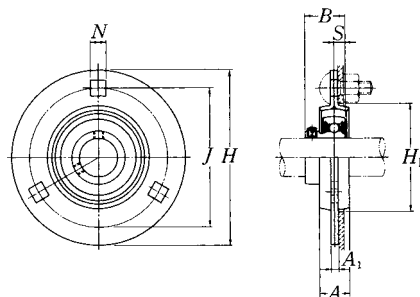

Shaft dia. mm inch	Unit number	Nominal dimensions								Bolt size mm inch
		H	J	A ₁	N	A	B	S	H ₁ min.	
12 1/2	ASRPF201 ASRPF201-008	90 3 ³⁵ / ₆₄	71.5 2 ¹³ / ₁₆	4 0.157	9 23/ ₆₄	16 5/ ₈	22 0.8661	6 0.236	56 2 ⁷ / ₃₂	M8 5/ ₁₆
15 9/ ₁₆ 5/ ₈	ASRPF202 ASRPF202-009 ASRPF202-010	90 3 ³⁵ / ₆₄	71.5 2 ¹³ / ₁₆	4 0.157	9 23/ ₆₄	16 5/ ₈	22 0.8661	6 0.236	56 2 ⁷ / ₃₂	M8 5/ ₁₆
17 11/ ₁₆	ASRPF203 ASRPF203-011	90 3 ³⁵ / ₆₄	71.5 2 ¹³ / ₁₆	4 0.157	9 23/ ₆₄	16 5/ ₈	22 0.8661	6 0.236	56 2 ⁷ / ₃₂	M8 5/ ₁₆
20 3/ ₄	ASRPF204 ASRPF204-012	95 3 ³ / ₄	76 2 ⁶³ / ₆₄	4 0.157	9 23/ ₆₄	18 23/ ₃₂	25 0.9843	7 0.276	60 2 ³ / ₈	M8 5/ ₁₆
25 13/ ₁₆ 7/ ₈ 15/ ₁₆ 1	ASRPF205 ASRPF205-013 ASRPF205-014 ASRPF205-015 ASRPF205-100	113 4 ⁷ / ₁₆	90.5 3 ⁹ / ₁₆	5.2 0.205	11 7/ ₁₆	18 23/ ₃₂	27 1.0630	7.5 0.295	71 2 ¹³ / ₁₆	M10 3/ ₈
30 1 ¹ / ₁₆ 1 ¹ / ₈ 1 ³ / ₁₆ 1 ¹ / ₄	ASRPF206 ASRPF206-101 ASRPF206-102 ASRPF206-103 ASRPF206-104	122 4 ¹³ / ₁₆	100 3 ¹⁵ / ₁₆	5.2 0.205	11 7/ ₁₆	20 25/ ₃₂	29 1.1417	8 0.315	81 3 ³ / ₁₆	M10 3/ ₈

Note (1) The permissible load only applies in applications where the load is stable and the speed is 2400 min⁻¹ or less.
Remarks When an anti-vibration rubber ring is used, the self alignment capability will be reduce.

Max. load (1) recommended		Bearing number	Housing number		Mass of unit kg lb
N lbf			rubber ring	steel	
1 000 220	200 40	AS201 AS201-008	R201 R201	PF204 PF204	0.2 0.4
1 000 220	200 40	AS202 AS202-009 AS202-010	R201 R201	PF204 PF204	0.2 0.4
1 000 220	200 40	AS203 AS203-011	R201 R201	PF204 PF204	0.2 0.4
1 150 250	200 40	AS204 AS204-012	R204 R204	PF205 PF205	0.2 0.4
1 300	200	AS205 AS205-013 AS205-014 AS205-015 AS205-100	R205 R205 R205 R205	PF206 PF206 PF206 PF206	0.3 0.7
1 500	200	AS206 AS206-101 AS206-102 AS206-103 AS206-104	R206 R206 R206 R206	PF207 PF207 PF207 PF207	0.5 1.1

Rhombus flanged unit, pressed steel housing Set screw type

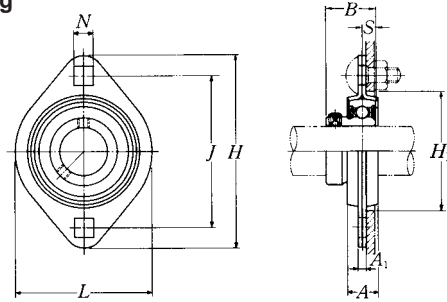

Shaft dia. mm inch	Unit number	Nominal dimensions										Bolt size mm inch
		H	J	A ₁	N	mm		L	B	S	H ₁ min.	
						A	L					
12 1/2	ASPFL201	81	63.5	4	7.1	14	59	22	6	49	M6	
	ASPFL201-008	3 3/16	2 1/2	0.157	9/32	9/16	2 5/16	0.8661	0.236	1 15/16	1/4	
15 9/16 5/8	ASPFL202	81	63.5	4	7.1	14	59	22	6	49	M6	
	ASPFL202-009 ASPFL202-010	3 3/16	2 1/2	0.157	9/32	9/16	2 5/16	0.8661	0.236	1 15/16	1/4	
17 11/16	ASPFL203	81	63.5	4	7.1	14	59	22	6	49	M6	
	ASPFL203-011	3 3/16	2 1/2	0.157	9/32	9/16	2 5/16	0.8661	0.236	1 15/16	1/4	
20 3/4	ASPFL204	90	71.5	4	9	16	67	25	7	56	M8	
	ASPFL204-012	3 5/8	2 13/16	0.157	23/64	5/8	2 5/8	0.9843	0.276	2 7/32	5/16	
25 13/16 7/8 15/16 1	ASPFL205	95	76	4	9	18	71	27	7.5	60	M8	
	ASPFL205-013	3 3/4	2 63/64	0.157	23/64	23/32	2 25/32	1.0630	0.295	2 3/8	5/16	
	ASPFL205-014											
	ASPFL205-015											
ASPFL205-100												
30 1 1/16 1 1/8 1 3/16 1 1/4	ASPFL206	113	90.5	5.2	11	18	84	29	8	71	M10	
	ASPFL206-101	4 7/16	3 9/16	0.205	7/16	23/32	3 5/16	1.1417	0.315	2 13/16	3/8	
	ASPFL206-102											
	ASPFL206-103											
ASPFL206-104												
35 1 1/4 1 5/16 1 3/8 1 7/16	ASPFL207	122	100	5.2	11	20	94	34	8.5	81	M10	
	ASPFL207-104	4 13/16	3 15/16	0.205	7/16	25/32	3 11/16	1.3386	0.335	3 3/16	3/8	
	ASPFL207-105											
	ASPFL207-106											
ASPFL207-107												
40 1 1/2 1 9/16	ASPFL208	148	119	6.8	13.5	21	100	38	9	91	M12	
	ASPFL208-108 ASPFL208-109	5 53/64	4 11/16	0.268	17/32	53/64	3 15/16	1.4961	0.354	3 19/32	1/2	

Note (1) The permissible load only applies in applications where the load is stable and the speed is 2400 min⁻¹ or less.

Max. load (1)		Bearing number	Housing number	Mass of unit
N lbf				
radial	axial			kg lb
2 700	1 350	AS201	PFL203	0.2
600	300	AS201-008	PFL203	0.4
2 700	1 350	AS202	PFL203	0.2
600	300	AS202-009 AS202-010	PFL203 PFL203	0.4
2 700	1 350	AS203	PFL203	0.2
600	300	AS203-011	PFL203	0.4
3 000	1 500	AS204	PFL204	0.2
660	330	AS204-012	PFL204	0.4
4 000	2 000	AS205	PFL205	0.3
880	440	AS205-013	PFL205	0.7
		AS205-014	PFL205	
		AS205-015 AS205-100	PFL205 PFL205	
5 000	2 500	AS206	PFL206	0.4
1 100	550	AS206-101	PFL206	0.9
		AS206-102	PFL206	
		AS206-103 AS206-104	PFL206 PFL206	
6 000	3 000	AS207	PFL207	0.6
1 300	650	AS207-104	PFL207	1.3
		AS207-105	PFL207	
		AS207-106 AS207-107	PFL207 PFL207	
6 000	3 000	AS208	PFL208	0.8
1 300	650	AS208-108 AS208-109	PFL208 PFL208	1.8

UCHB2

Hanger unit, cast housing Set screw type

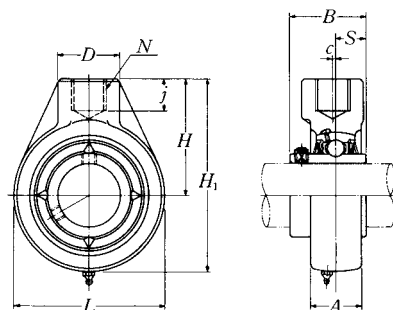

Shaft dia. mm inch	Unit number (1)	Nominal dimensions									
		mm inch									
		L	H ₁	c	A	H	N	D	j	B	S
12 1/2	UCHB201D1	64	96	0	21	64	Rp 3/4	40	19	31	12.7
	UCHB201-008D1	2 17/32	3 25/32	0	13/16	2 33/64	Rp 3/4	1 9/16	3/4	1.2205	0.500
15 9/16 5/8	UCHB202D1	64	96	0	21	64	Rp 3/4	40	19	31	12.7
	UCHB202-009D1 UCHB202-010D1	2 17/32	3 25/32	0	13/16	2 33/64	Rp 3/4	1 9/16	3/4	1.2205	0.500
17 11/16	UCHB203D1	64	96	0	21	64	Rp 3/4	40	19	31	12.7
	UCHB203-011D1	2 17/32	3 25/32	0	13/16	2 33/64	Rp 3/4	1 9/16	3/4	1.2205	0.500
20 3/4	UCHB204D1	64	96	0	21	64	Rp 3/4	40	19	31	12.7
	UCHB204-012D1	2 17/32	3 25/32	0	13/16	2 33/64	Rp 3/4	1 9/16	3/4	1.2205	0.500
25 13/16 7/8 15/16 1	UCHB205D1	78	103	0	24	64	Rp 3/4	40	19	34.1	14.3
	UCHB205-013D1										
	UCHB205-014D1	3 1/16	4 1/16	0	1 5/16	2 33/64	Rp 3/4	1 9/16	3/4	1.3425	0.563
	UCHB205-015D1 UCHB205-100D1										
30 1 1/16 1 1/8 1 3/16 1 1/4	UCHB206D1	78	103	0	28	64	Rp 3/4	40	19	38.1	15.9
	UCHB206-101D1										
	UCHB206-102D1	3 1/16	4 1/16	0	1 3/32	2 33/64	Rp 3/4	1 9/16	3/4	1.5000	0.626
	UCHB206-103D1 UCHB206-104D1										
35 1 1/4 1 5/16 1 3/8 1 7/16	UCHB207D1	92	116	0	30	70	Rp 3/4	40	19	42.9	17.5
	UCHB207-104D1										
	UCHB207-105D1	3 5/8	4 9/16	0	1 3/16	2 3/4	Rp 3/4	1 9/16	3/4	1.6890	0.689
	UCHB207-106D1 UCHB207-107D1										
40 1 1/2 1 9/16	UCHB208D1	96	121	2	33	73	Rp 3/4	40	19	49.2	19
	UCHB208-108D1 UCHB208-109D1	3 25/32	4 3/4	3/32	1 5/16	2 7/8	Rp 3/4	1 9/16	3/4	1.9370	0.748

Note (1) These numbers indicate relubricatable type. If maintenance free type is needed, please order without suffix "D1".
Remarks Please refer to page A21 for size of grease fitting.

Nominal Designation of Thread N	Nominal dimensions mm				
	Major Diameter of Internal Thread	Pitch Diameter	Minor Diameter of Internal Thread	Tolerances	Mounting Bolt size
Rp 3/4 (PS 3/4)	26.441	25.279	24.117	±0.142	R 3/4 (PT 3/4)
Rp 1 (PS 1)	33.249	31.770	30.291	±0.181	R 1 (PT 1)
Rp 1 1/4 (PS 1 1/4)	41.910	40.431	38.952	±0.181	R 1 1/4 (PT 1 1/4)
Rp 1 1/2 (PS 1 1/2)	47.803	46.324	44.845	±0.181	R 1 1/2 (PT 1 1/2)

Bearing number	Housing number	Mass of unit kg lb
UC201D1	HB204D1	1.0
UC201-008D1	HB204D1	2.2
UC202D1	HB204D1	0.9
UC202-009D1	HB204D1	2.0
UC202-010D1	HB204D1	
UC203D1	HB204D1	0.9
UC203-011D1	HB204D1	2.0
UC204D1	HB204D1	0.9
UC204-012D1	HB204D1	2.0
UC205D1	HB205D1	0.9
UC205-013D1	HB205D1	
UC205-014D1	HB205D1	2.0
UC205-015D1	HB205D1	
UC205-100D1	HB205D1	
UC206D1	HB206D1	0.8
UC206-101D1	HB206D1	
UC206-102D1	HB206D1	1.8
UC206-103D1	HB206D1	
UC206-104D1	HB206D1	
UC207D1	HB207D1	1.2
UC207-104D1	HB207D1	
UC207-105D1	HB207D1	2.6
UC207-106D1	HB207D1	
UC207-107D1	HB207D1	
UC208D1	HB208D1	1.3
UC208-108D1	HB208D1	2.9
UC208-109D1	HB208D1	

UCHB2

Hanger unit, cast housing Set screw type

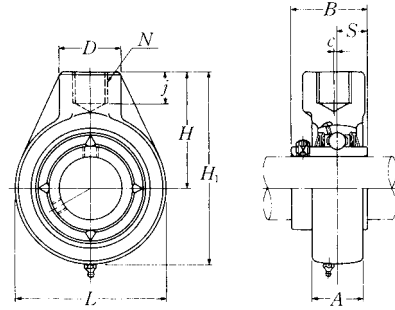

Shaft dia. mm inch	Unit number (*)	Nominal dimensions									
		mm inch									
		L	H ₁	c	A	H	N	D	j	B	S
45	UCHB209D1	108	136	5	35	82	Rp1	48	21	49.2	19
1 5/8	UCHB209-110D1										
1 1/16	UCHB209-111D1	4 1/4	5 11/32	3/16	1 3/8	3 15/64	Rp1	1 7/8	13/16	1.9370	0.748
1 3/4	UCHB209-112D1										
50	UCHB210D1	118	142	5	37	83	Rp1	48	21	51.6	19
1 13/16	UCHB210-113D1										
1 7/8	UCHB210-114D1	4 21/32	5 19/32	3/16	1 15/32	3 17/64	Rp1	1 7/8	13/16	2.0315	0.748
1 5/16	UCHB210-115D1										
2	UCHB210-200D1										
55	UCHB211D1	126	158	7	38	95	Rp1 1/4	60	25	55.6	22.2
2	UCHB211-200D1										
2 1/16	UCHB211-201D1	4 31/32	6 7/32	9/32	1 1/2	3 47/64	Rp1 1/4	2 3/8	31/32	2.1890	0.874
2 1/8	UCHB211-202D1										
2 3/16	UCHB211-203D1										
60	UCHB212D1	142	173	9	42	102	Rp1 1/4	60	28	65.1	25.4
2 1/4	UCHB212-204D1										
2 5/16	UCHB212-205D1	5 19/32	6 13/16	11/32	1 21/32	4 1/64	Rp1 1/4	2 3/8	1 3/32	2.5630	1.000
2 3/8	UCHB212-206D1										
2 7/16	UCHB212-207D1										
65	UCHB213D1	166	200	9.5	44	117	Rp1 1/2	70	32	65.1	25.4
2 1/2	UCHB213-208D1	6 17/32	7 7/8	3/8	1 23/32	4 39/64	Rp1 1/2	2 3/4	1 1/4	2.5630	1.000

Note (*) These numbers indicate relubricatable type. If maintenance free type is needed, please order without suffix "D1".

Remarks Please refer to page A21 for size of grease fitting.

Nominal Designation of Thread N	Nominal dimensions mm				
	Major Diameter of Internal Thread	Pitch Diameter	Minor Diameter of Internal Thread	Tolerances	Mounting Bolt size
Rp 3/4 (PS 3/4)	26.441	25.279	24.117	±0.142	R 3/4 (PT 3/4)
Rp1 (PS1)	33.249	31.770	30.291	±0.181	R1 (PT1)
Rp1 1/4 (PS1 1/4)	41.910	40.431	38.952	±0.181	R1 1/4 (PT1 1/4)
Rp1 1/2 (PS1 1/2)	47.803	46.324	44.845	±0.181	R1 1/2 (PT1 1/2)

Bearing number	Housing number	Mass of unit kg lb
UC209D1	HB209D1	1.8
UC209-110D1	HB209D1	
UC209-111D1	HB209D1	4.0
UC209-112D1	HB209D1	
UC210D1	HB210D1	2.2
UC210-113D1	HB210D1	
UC210-114D1	HB210D1	4.9
UC210-115D1	HB210D1	
UC210-200D1	HB210D1	
UC211D1	HB211D1	2.8
UC211-200D1	HB211D1	
UC211-201D1	HB211D1	6.2
UC211-202D1	HB211D1	
UC211-203D1	HB211D1	
UC212D1	HB212D1	3.7
UC212-204D1	HB212D1	
UC212-205D1	HB212D1	8.2
UC212-206D1	HB212D1	
UC212-207D1	HB212D1	
UC213D1	HB213D1	5.7
UC213-208D1	HB213D1	13

Take-up unit, cast housing Set screw type

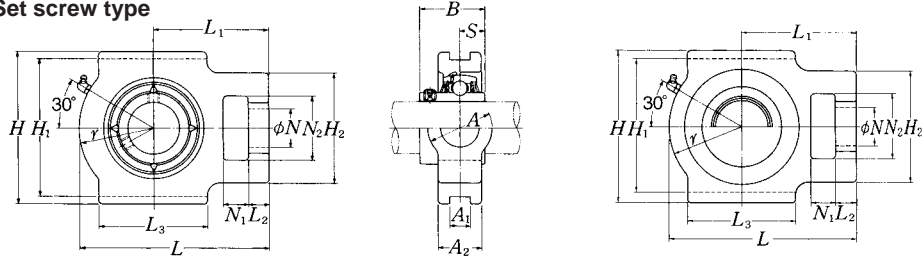

Pressed steel dust cover type
Open end **Z-UCT...D1**
Closed end **ZM-UCT...D1**

Shaft dia. mm inch	Unit number (1)	Nominal dimensions															
		mm inch															
		N_1	L_2	H_2	N_2	N	L_3	A_1	H_1	H	L	A_2	A	r	L_1	B	S
12 1/2	UCT201D1 UCT201-008D1	16 5/8	12 15/32	51 2	32 1 1/4	19 3/4	51 2	12 0.472	76 2 63/64	89 3 1/2	94 3 11/16	21 13/16	32 1 1/4	33 1 5/16	61 2 13/32	31 1.2205	12.7 0.500
15 9/16 5/8	UCT202D1 UCT202-009D1 UCT202-010D1	16 5/8	12 15/32	51 2	32 1 1/4	19 3/4	51 2	12 0.472	76 2 63/64	89 3 1/2	94 3 11/16	21 13/16	32 1 1/4	33 1 5/16	61 2 13/32	31 1.2205	12.7 0.500
17 1 1/16	UCT203D1 UCT203-011D1	16 5/8	12 15/32	51 2	32 1 1/4	19 3/4	51 2	12 0.472	76 2 63/64	89 3 1/2	94 3 11/16	21 13/16	32 1 1/4	33 1 5/16	61 2 13/32	31 1.2205	12.7 0.500
20 3/4	UCT204D1 UCT204-012D1	16 5/8	12 15/32	51 2	32 1 1/4	19 3/4	51 2	12 0.472	76 2 63/64	89 3 1/2	94 3 11/16	21 13/16	32 1 1/4	33 1 5/16	61 2 13/32	31 1.2205	12.7 0.500
25 13/16 7/8 15/16 1	UCT205D1 UCT205-013D1 UCT205-014D1 UCT205-015D1 UCT205-100D1	16 5/8	12 15/32	51 2	32 1 1/4	19 3/4	51 2	12 0.472	76 2 63/64	89 3 1/2	97 3 3/4	24 15/16	32 1 1/4	35 1 3/8	62 2 7/16	34.1 1.3425	14.3 0.563
30 1 1/16 1 1/8 1 3/16 1 1/4	UCT206D1 UCT206-101D1 UCT206-102D1 UCT206-103D1 UCT206-104D1	16 5/8	12 15/32	56 2 7/32	37 1 15/32	22 7/8	57 2 1/4	12 0.472	89 3 1/2	102 4 1/32	113 4 7/16	28 1 3/32	37 1 15/32	43 1 11/16	70 2 3/4	38.1 1.5000	15.9 0.626
35 1 1/4 1 5/16 1 3/8 1 1/2	UCT207D1 UCT207-104D1 UCT207-105D1 UCT207-106D1 UCT207-107D1	16 5/8	15 19/32	64 2 17/32	37 1 15/32	22 7/8	64 2 17/32	12 0.472	89 3 1/2	102 4 1/32	129 5 3/32	30 1 3/16	37 1 15/32	51 2	78 3 1/16	42.9 1.6890	17.5 0.689
40 1 1/2 1 5/8	UCT208D1 UCT208-108D1 UCT208-109D1	19 3/4	18 23/32	83 3 9/32	49 1 15/16	29 1 5/32	83 3 9/32	16 0.630	102 4 1/4	114 4 1/2	144 5 21/32	33 1 5/16	49 1 15/16	56 2 7/32	88 3 15/32	49.2 1.9370	19 0.748

Note (1) These numbers indicate relubricatable type. If maintenance free type is needed, please order without suffix "D1".
Remarks Please refer to page A21 for size of grease fitting.

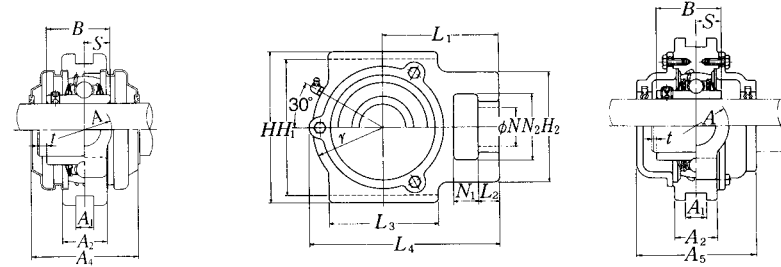

Cast dust cover type
Open end **C-UCT...D1**
Closed end **CM-UCT...D1**

Bearing number	Housing number	Unit number (1) pressed steel dust cover type	Unit number (1) cast dust cover type	Nominal dimensions				Mass of unit		
				mm inch				kg lb		
				t max.	A_4	L_4	A_5	UCT	Z(ZM)	C(CM)
UC201D1 UC201-008D1	T204D1 T204D1	Z(ZM)-UCT201D1 Z(ZM)-UCT201-008D1	C(CM)-UCT201D1 C(CM)-UCT201-008D1	2 5/64	45 1 25/32	97 3 13/16	62 2 7/16	0.6 1.3	0.8 1.8	1.1 2.4
UC202D1 UC202-009D1 UC202-010D1	T204D1 T204D1 T204D1	Z(ZM)-UCT202D1 Z(ZM)-UCT202-009D1 Z(ZM)-UCT202-010D1	C(CM)-UCT202D1 C(CM)-UCT202-009D1 C(CM)-UCT202-010D1	2 5/64	45 1 25/32	97 3 13/16	62 2 7/16	0.6 1.3	0.8 1.8	1.1 2.4
UC203D1 UC203-011D1	T204D1 T204D1	Z(ZM)-UCT203D1 Z(ZM)-UCT203-011D1	C(CM)-UCT203D1 C(CM)-UCT203-011D1	2 5/64	45 1 35/32	97 3 13/16	62 2 7/16	0.6 1.3	0.8 1.8	1.0 2.2
UC204D1 UC204-012D1	T204D1 T204D1	Z(ZM)-UCT204D1 Z(ZM)-UCT204-012D1	C(CM)-UCT204D1 C(CM)-UCT204-012D1	2 5/64	45 1 25/32	97 3 13/16	62 2 7/16	0.6 1.3	0.8 1.8	1.0 2.2
UC205D1 UC205-013D1 UC205-014D1 UC205-015D1 UC205-100D1	T205D1 T205D1 T205D1 T205D1 T205D1	Z(ZM)-UCT205D1 Z(ZM)-UCT205-013D1 Z(ZM)-UCT205-014D1 Z(ZM)-UCT205-015D1 Z(ZM)-UCT205-100D1	C(CM)-UCT205D1 C(CM)-UCT205-013D1 C(CM)-UCT205-014D1 C(CM)-UCT205-015D1 C(CM)-UCT205-100D1	2 5/64	48 1 29/32	100.5 3 31/32	70 2 3/4	0.8 1.8	0.9 2.0	1.1 2.4
UC206D1 UC206-101D1 UC206-102D1 UC206-103D1 UC206-104D1	T206D1 T206D1 T206D1 T206D1 T206D1	Z(ZM)-UCT206D1 Z(ZM)-UCT206-101D1 Z(ZM)-UCT206-102D1 Z(ZM)-UCT206-103D1 —	C(CM)-UCT206D1 C(CM)-UCT206-101D1 C(CM)-UCT206-102D1 C(CM)-UCT206-103D1 C(CM)-UCT206-104D1	2 5/64	53 2 3/32	113.5 4 15/32	75 2 15/16	1.3 2.9	1.3 2.9	1.7 3.7
UC207D1 UC207-104D1 UC207-105D1 UC207-106D1 UC207-107D1	T207D1 T207D1 T207D1 T207D1 T207D1	Z(ZM)-UCT207D1 Z(ZM)-UCT207-104D1 Z(ZM)-UCT207-105D1 Z(ZM)-UCT207-106D1 —	C(CM)-UCT207D1 C(CM)-UCT207-104D1 C(CM)-UCT207-105D1 C(CM)-UCT207-106D1 C(CM)-UCT207-107D1	3 1/8	60 2 1 1/2	129 5 3/32	80 3 5/32	1.6 3.5	1.7 3.7	2.1 4.6
UC208D1 UC208-108D1 UC208-109D1	T208D1 T208D1 T208D1	Z(ZM)-UCT208D1 Z(ZM)-UCT208-108D1 Z(ZM)-UCT208-109D1	C(CM)-UCT208D1 C(CM)-UCT208-108D1 C(CM)-UCT208-109D1	3 1/8	69 2 23/32	144 5 21/32	90 3 17/32	2.4 5.3	2.5 5.5	3.1 6.8

Take-up unit, cast housing Set screw type

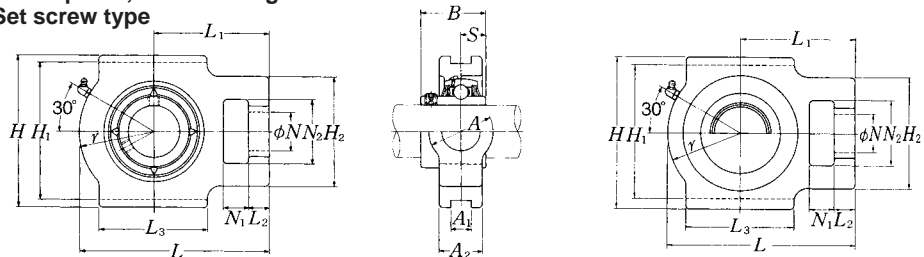

Pressed steel dust cover type
Open end **Z-UCT...D1**
Closed end **ZM-UCT...D1**

Shaft dia. mm inch	Unit number (1)	Nominal dimensions															
		mm inch															
		N_1	L_2	H_2	N_2	N	L_3	A_1	H_1	H	L	A_2	A	r	L_1	B	S
45	UCT209D1	19	18	83	49	29	83	16	102	117	145	35	49	57	88	49.2	19
$1\frac{5}{8}$	UCT209-110D1																
$1\frac{1}{16}$	UCT209-111D1	$\frac{3}{4}$	$\frac{23}{32}$	$3\frac{9}{32}$	$1\frac{15}{16}$	$1\frac{5}{32}$	$3\frac{9}{32}$	0.630	$4\frac{1}{64}$	$4\frac{19}{32}$	$5\frac{23}{32}$	$1\frac{1}{8}$	$1\frac{15}{16}$	$2\frac{1}{4}$	$3\frac{15}{32}$	1.9370	0.748
$1\frac{3}{4}$	UCT209-112D1																
50	UCT210D1	19	18	83	49	29	86	16	102	117	151	37	49	59	92	51.6	19
$1\frac{3}{16}$	UCT210-113D1																
$1\frac{7}{8}$	UCT210-114D1	$\frac{3}{4}$	$\frac{23}{32}$	$3\frac{9}{32}$	$1\frac{15}{16}$	$1\frac{5}{32}$	$3\frac{3}{8}$	0.630	$4\frac{1}{64}$	$4\frac{19}{32}$	$5\frac{15}{16}$	$1\frac{1}{32}$	$1\frac{15}{16}$	$2\frac{5}{16}$	$3\frac{5}{8}$	2.0315	0.748
$1\frac{1}{16}$	UCT210-115D1																
2	UCT210-200D1																
55	UCT211D1	25	21	102	64	35	95	22	130	146	171	38	64	65	106	55.6	22.2
2	UCT211-200D1																
$2\frac{1}{16}$	UCT211-201D1	$\frac{31}{32}$	$\frac{13}{16}$	$4\frac{1}{32}$	$2\frac{17}{32}$	$1\frac{3}{8}$	$3\frac{3}{4}$	0.866	$5\frac{1}{8}$	$5\frac{3}{4}$	$6\frac{23}{32}$	$1\frac{1}{2}$	$2\frac{17}{32}$	$2\frac{9}{16}$	$4\frac{3}{16}$	2.1890	0.874
$2\frac{1}{8}$	UCT211-202D1																
$2\frac{3}{16}$	UCT211-203D1																
60	UCT212D1	32	21	102	64	35	102	22	130	146	194	42	64	75	119	65.1	25.4
$2\frac{3}{4}$	UCT212-204D1																
$2\frac{5}{16}$	UCT212-205D1	$1\frac{1}{4}$	$\frac{13}{16}$	$4\frac{1}{32}$	$2\frac{17}{32}$	$1\frac{3}{8}$	$4\frac{1}{32}$	0.866	$5\frac{1}{8}$	$5\frac{3}{4}$	$7\frac{5}{8}$	$1\frac{21}{32}$	$2\frac{17}{32}$	$2\frac{15}{16}$	$4\frac{11}{16}$	2.5630	1.000
$2\frac{3}{8}$	UCT212-206D1																
$2\frac{7}{16}$	UCT212-207D1																
65	UCT213D1	32	23	111	70	41	121	26	151	167	224	44	70	87	137	65.1	25.4
$2\frac{1}{2}$	UCT213-208D1																
$2\frac{7}{16}$	UCT213-209D1	$1\frac{1}{4}$	$\frac{29}{32}$	$4\frac{3}{8}$	$2\frac{3}{4}$	$1\frac{5}{8}$	$4\frac{3}{4}$	1.024	$5\frac{15}{16}$	$6\frac{9}{16}$	$8\frac{13}{16}$	$1\frac{23}{32}$	$2\frac{3}{4}$	$3\frac{7}{16}$	$5\frac{13}{32}$	2.5630	1.000
70	UCT214D1	32	23	111	70	41	121	26	151	167	224	46	70	87	137	74.6	30.2
$2\frac{5}{8}$	UCT214-210D1																
$2\frac{1}{16}$	UCT214-211D1	$1\frac{1}{4}$	$\frac{29}{32}$	$4\frac{3}{8}$	$2\frac{3}{4}$	$1\frac{5}{8}$	$4\frac{3}{4}$	1.024	$5\frac{15}{16}$	$6\frac{9}{16}$	$8\frac{13}{16}$	$1\frac{1}{16}$	$2\frac{3}{4}$	$3\frac{7}{16}$	$5\frac{13}{32}$	2.9370	1.189
$2\frac{3}{4}$	UCT214-212D1																

Note (1) These numbers indicate relubricatable type. If maintenance free type is needed, please order without suffix "D1".

Remarks Please refer to page A21 for size of grease fitting.

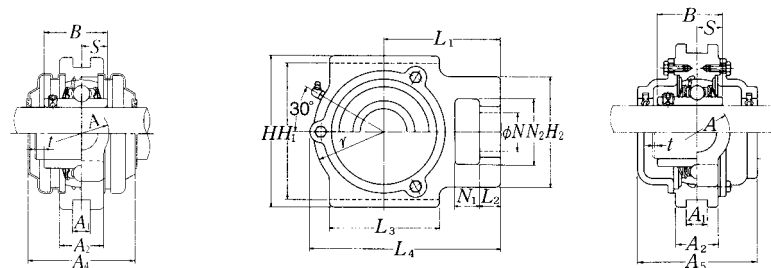

Cast dust cover type
Open end **C-UCT...D1**
Closed end **CM-UCT...D1**

Bearing number	Housing number	Unit number (1) pressed steel dust cover type	Unit number (1) cast dust cover type	Nominal dimensions					Mass of unit		
				mm inch					kg lb		
				t max.	A_4	L_4	A_5	UCT	Z(ZM)	C(CM)	
UC209D1	T209D1	Z(ZM)-UCT209D1	C(CM)-UCT209D1	3	69	145.5	95	2.4	2.5	3.3	
UC209-110D1	T209D1	Z(ZM)-UCT209-110D1	C(CM)-UCT209-110D1								
UC209-111D1	T209D1	Z(ZM)-UCT209-111D1	C(CM)-UCT209-111D1	$\frac{1}{8}$	$2\frac{23}{32}$	$5\frac{23}{32}$	$3\frac{3}{4}$	5.3	5.5	7.3	
UC209-112D1	T209D1	Z(ZM)-UCT209-112D1	C(CM)-UCT209-112D1								
UC210D1	T210D1	Z(ZM)-UCT210D1	C(CM)-UCT210D1	3	76	152	100	2.6	2.7	3.6	
UC210-113D1	T210D1	Z(ZM)-UCT210-113D1	C(CM)-UCT210-113D1								
UC210-114D1	T210D1	Z(ZM)-UCT210-114D1	C(CM)-UCT210-114D1	$\frac{1}{8}$	3	$5\frac{31}{32}$	$3\frac{15}{16}$	5.7	6.0	7.9	
UC210-115D1	T210D1	Z(ZM)-UCT210-115D1	C(CM)-UCT210-115D1								
UC210-200D1	T210D1	—	C(CM)-UCT210-200D1								
UC211D1	T211D1	Z(ZM)-UCT211D1	C(CM)-UCT211D1	4	77	171.5	100	3.9	4.1	5.0	
UC211-200D1	T211D1	Z(ZM)-UCT211-200D1	C(CM)-UCT211-200D1								
UC211-201D1	T211D1	Z(ZM)-UCT211-201D1	C(CM)-UCT211-201D1	$\frac{5}{32}$	$3\frac{1}{32}$	$6\frac{3}{4}$	$3\frac{15}{16}$	8.6	9.0	11	
UC211-202D1	T211D1	Z(ZM)-UCT211-202D1	C(CM)-UCT211-202D1								
UC211-203D1	T211D1	Z(ZM)-UCT211-203D1	C(CM)-UCT211-203D1								
UC212D1	T212D1	Z(ZM)-UCT212D1	C(CM)-UCT212D1	4	89	194	115	4.8	5.1	6.1	
UC212-204D1	T212D1	Z(ZM)-UCT212-204D1	C(CM)-UCT212-204D1								
UC212-205D1	T212D1	Z(ZM)-UCT212-205D1	C(CM)-UCT212-205D1	$\frac{5}{32}$	$3\frac{1}{2}$	$7\frac{5}{8}$	$4\frac{17}{32}$	11	11	13	
UC212-206D1	T212D1	Z(ZM)-UCT212-206D1	C(CM)-UCT212-206D1								
UC212-207D1	T212D1	—	C(CM)-UCT212-207D1								
UC213D1	T213D1	Z(ZM)-UCT213D1	C(CM)-UCT213D1	4	91	224	120	7.0	7.3	8.4	
UC213-208D1	T213D1	Z(ZM)-UCT213-208D1	C(CM)-UCT213-208D1	$\frac{5}{32}$	$3\frac{19}{32}$	$8\frac{13}{16}$	$4\frac{23}{32}$	15	16	19	
UC213-209D1	T213D1	Z(ZM)-UCT213-209D1	C(CM)-UCT213-209D1								
UC214D1	T214D1	—	C(CM)-UCT214D1	4	—	224	135	7.0	—	9.1	
UC214-210D1	T214D1	—	C(CM)-UCT214-201D1								
UC214-211D1	T214D1	—	C(CM)-UCT214-211D1	$\frac{5}{32}$	—	$8\frac{13}{16}$	$5\frac{5}{16}$	15	—	20	
UC214-212D1	T214D1	—	C(CM)-UCT214-212D1								

Take-up unit, cast housing Set screw type

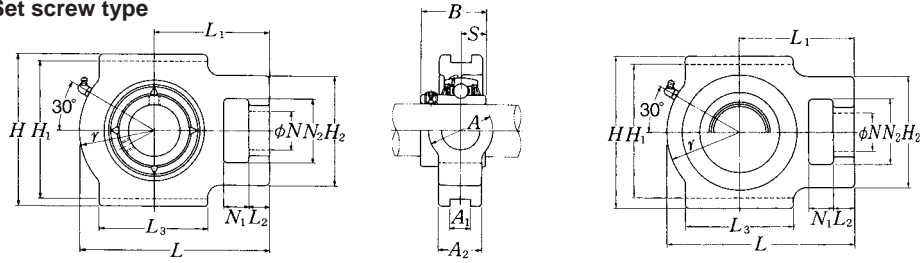

Pressed steel dust cover type
Open end **Z-UCT...D1**
Closed end **ZM-UCT...D1**

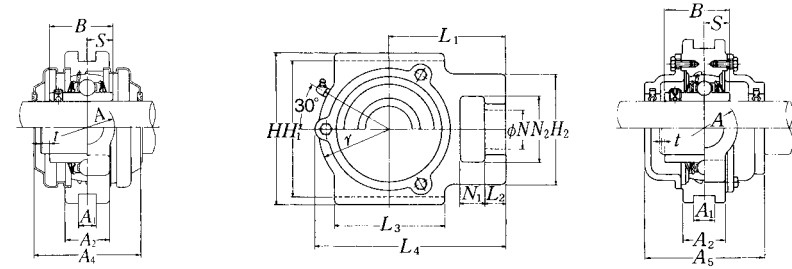

Cast dust cover type
Open end **C-UCT...D1**
Closed end **CM-UCT...D1**

Shaft dia. mm inch	Unit number (1)	Nominal dimensions															
		mm inch															
		N_1	L_2	H_2	N_2	N	L_3	A_1	H_1	H	L	A_2	A	r	L_1	B	S
75 2 ³ / ₁₆ 2 ⁷ / ₈ 2 ⁵ / ₁₆ 3	UCT215D1 UCT215-213D1 UCT215-214D1 UCT215-215D1 UCT215-300D1	32	23	111	70	41	121	26	151	167	232	48	70	92	140	77.8	33.3
		1 ¹ / ₄	²⁹ / ₃₂	4 ³ / ₈	2 ³ / ₄	1 ⁵ / ₈	4 ³ / ₄	1.024	5 ¹⁵ / ₁₆	6 ⁹ / ₁₆	9 ¹ / ₈	1 ⁷ / ₈	2 ³ / ₄	3 ⁵ / ₈	5 ¹ / ₂	3.0630	1.311
80 3 ¹ / ₁₆ 3 ¹ / ₈ 3 ³ / ₁₆	UCT216D1 UCT216-301D1 UCT216-302D1 UCT216-303D1	32	23	111	70	41	121	26	165	184	235	51	70	95	140	82.6	33.3
		1 ¹ / ₄	²⁹ / ₃₂	4 ³ / ₈	2 ³ / ₄	1 ⁵ / ₈	4 ³ / ₄	1.024	6 ¹ / ₂	7 ¹ / ₄	9 ¹ / ₄	2	2 ³ / ₄	3 ³ / ₄	5 ¹ / ₂	3.2520	1.311
85 3 ¹ / ₄ 3 ⁵ / ₁₆ 3 ⁷ / ₁₆	UCT217D1 UCT217-304D1 UCT217-305D1 UCT217-307D1	38	31	124	73	48	157	30	173	198	260	54	73	98	162	85.7	34.1
		1 ¹ / ₂	1 ⁷ / ₃₂	4 ⁷ / ₈	2 ⁷ / ₈	1 ⁷ / ₈	6 ³ / ₁₆	1.181	6 ¹³ / ₁₆	7 ²⁵ / ₃₂	10 ¹ / ₄	2 ¹ / ₈	2 ⁷ / ₈	3 ²⁷ / ₃₂	6 ³ / ₈	3.3740	1.343

Note (1) These numbers indicate relubricatable type. If maintenance free type is needed, please order without suffix "D1".
Remarks Please refer to page A21 for size of grease fitting.

Bearing number	Housing number	Unit number (1) pressed steel dust cover type	Unit number (1) cast dust cover type	Nominal dimensions					Mass of unit		
				mm inch					kg lb		
				t max.	A_4	L_4	A_5	UCT	Z(ZM)	C(CM)	
UC215D1	T215D1	—	C(CM)-UCT215D1	4	—	232	135	7.4	—	9.8	
UC215-213D1	T215D1	—	C(CM)-UCT215-213D1	—	—	—	—	—	—	—	
UC215-214D1	T215D1	—	C(CM)-UCT215-214D1	⁵ / ₃₂	—	9 ¹ / ₈	5 ⁵ / ₁₆	16	—	22	
UC215-215D1	T215D1	—	C(CM)-UCT215-215D1	—	—	—	—	—	—	—	
UC215-300D1	T215D1	—	C(CM)-UCT215-300D1	—	—	—	—	—	—	—	
UC216D1	T216D1	—	C(CM)-UCT216D1	4	—	235	145	8.2	—	11	
UC216-301D1	T216D1	—	C(CM)-UCT216-301D1	—	—	—	—	—	—	—	
UC216-302D1	T216D1	—	C(CM)-UCT216-302D1	⁵ / ₃₂	—	9 ¹ / ₄	5 ²³ / ₃₂	18	—	24	
UC216-303D1	T216D1	—	C(CM)-UCT216-303D1	—	—	—	—	—	—	—	
UC217D1	T217D1	—	C(CM)-UCT217D1	5	—	260	155	11	—	14	
UC217-304D1	T217D1	—	C(CM)-UCT217-304D1	—	—	—	—	—	—	—	
UC217-305D1	T217D1	—	C(CM)-UCT217-305D1	¹³ / ₆₄	—	10 ¹ / ₄	6 ³ / ₃₂	24	—	31	
UC217-307D1	T217D1	—	C(CM)-UCT217-307D1	—	—	—	—	—	—	—	

Take-up unit, cast housing Set screw type

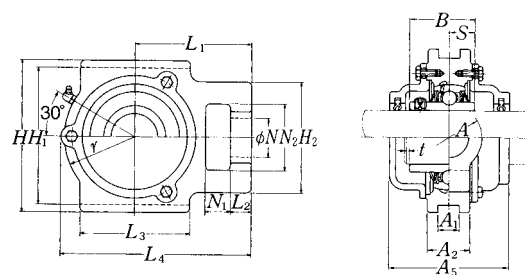
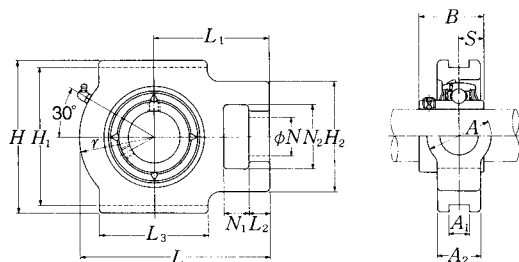

Cast dust cover type
Open end **C-UCT...D1**
Closed end **CM-UCT...D1**

Shaft dia. mm inch	Unit number (1)	Nominal dimensions															
		mm inch															
		N_1	L_2	H_2	N_2	N	L_3	A_1	H_1	H	L	A_2	A	r	L_1	B	S
25 1 3/16 7/8 15/16 1	UCT305D1 UCT305-013D1 UCT305-014D1 UCT305-015D1 UCT305-100D1	16	14	62	36	26	65	12	80	89	122	26	36	46	76	38	15
		5/8	9/16	2 7/16	1 13/32	1 1/32	2 9/16	0.472	3 5/32	3 1/2	4 13/16	1 1/32	1 13/16	1 13/16	3	1.4961	0.591
30 1 1/16 1 1/8 1 3/16	UCT306D1 UCT306-101D1 UCT306-102D1 UCT306-103D1	18	16	70	41	28	74	16	90	100	137	28	41	52	85	43	17
		23/32	5/8	2 3/4	1 5/8	1 3/32	2 29/32	0.630	3 35/64	3 15/16	5 13/32	1 3/32	1 5/8	2 1/16	3 11/32	1.6929	0.669
35 1 1/4 1 5/16 1 3/8 1 7/16	UCT307D1 UCT307-104D1 UCT307-105D1 UCT307-106D1 UCT307-107D1	20	17	75	45	30	80	16	100	111	150	32	45	56	94	48	19
		25/32	21/32	2 15/16	1 25/32	1 3/16	3 5/32	0.630	3 15/16	4 3/8	5 29/32	1 1/4	1 25/32	2 7/32	3 11/16	1.8898	0.748
40 1 1/2 1 9/16	UCT308D1 UCT308-108D1 UCT308-109D1	22	19	83	50	32	89	18	112	124	162	34	50	62	100	52	19
		7/8	3/4	3 9/32	1 31/32	1 1/4	3 1/2	0.709	4 13/32	4 7/8	6 3/8	1 11/32	1 31/32	2 7/16	3 15/16	2.0472	0.748
45 1 5/8 1 11/16 1 3/4	UCT309D1 UCT309-110D1 UCT309-111D1 UCT309-112D1	24	20	90	55	34	97	18	125	138	178	38	55	68	110	57	22
		15/16	25/32	3 17/32	2 5/32	1 11/32	3 13/16	0.709	4 59/64	5 7/16	7	1 1/2	2 5/32	2 11/16	4 11/32	2.2441	0.866
50 1 3/16 1 1/8 1 15/16	UCT310D1 UCT310-113D1 UCT310-114D1 UCT310-115D1	27	22	98	61	37	106	20	140	151	192	40	61	74	118	61	22
		1 1/16	7/8	3 27/32	2 13/32	1 15/32	4 3/16	0.787	5 33/64	5 15/16	7 7/16	1 9/16	2 13/32	2 29/32	4 21/32	2.4016	0.866

Note (1) These numbers indicate relubricatable type. If maintenance free type is needed, please order without suffix "D1".

Remarks Please refer to page A21 for size of grease fitting.

Bearing number	Housing number	Unit number (1) cast dust cover type	Nominal dimensions			Mass of unit	
			mm inch			kg lb	
			t max.	L_4	A_5	UCT	C(CM)
UC305D1	T305D1	C(CM)-UCT305D1	2	122	80	1.4	1.7
UC305-013D1	T305D1	C(CM)-UCT305-013D1					
UC305-014D1	T305D1	C(CM)-UCT305-014D1					
UC305-015D1	T305D1	C(CM)-UCT305-015D1	5/64	4 13/16	3 5/32	3.1	3.7
UC305-100D1	T305D1	C(CM)-UCT305-100D1					
UC306D1	T306D1	C(CM)-UCT306D1	2	139	85	1.8	2.4
UC306-101D1	T306D1	C(CM)-UCT306-101D1					
UC306-102D1	T306D1	C(CM)-UCT306-102D1	5/64	5 15/32	3 11/32	4.0	5.3
UC306-103D1	T306D1	C(CM)-UCT306-103D1					
UC307D1	T307D1	C(CM)-UCT307D1	3	152	95	2.3	3.2
UC307-104D1	T307D1	C(CM)-UCT307-104D1					
UC307-105D1	T307D1	C(CM)-UCT307-105D1					
UC307-106D1	T307D1	C(CM)-UCT307-106D1	1/8	5 31/32	3 3/4	5.1	7.1
UC307-107D1	T307D1	C(CM)-UCT307-107D1					
UC308D1	T308D1	C(CM)-UCT308D1	3	164	105	3.0	4.2
UC308-108D1	T308D1	C(CM)-UCT308-108D1	1/8	6 15/32	4 1/8	6.6	9.3
UC308-109D1	T308D1	C(CM)-UCT308-109D1					
UC309D1	T309D1	C(CM)-UCT309D1	3	181	110	4.0	5.4
UC309-110D1	T309D1	C(CM)-UCT309-110D1					
UC309-111D1	T309D1	C(CM)-UCT309-111D1	1/8	7 1/8	4 11/32	8.8	12
UC309-112D1	T309D1	C(CM)-UCT309-112D1					
UC310D1	T310D1	C(CM)-UCT310D1	3	197	120	5.0	7.0
UC310-113D1	T310D1	C(CM)-UCT310-113D1					
UC310-114D1	T310D1	C(CM)-UCT310-114D1	1/8	7 3/4	4 23/32	11	15
UC310-115D1	T310D1	C(CM)-UCT310-115D1					

Take-up unit, cast housing Set screw type

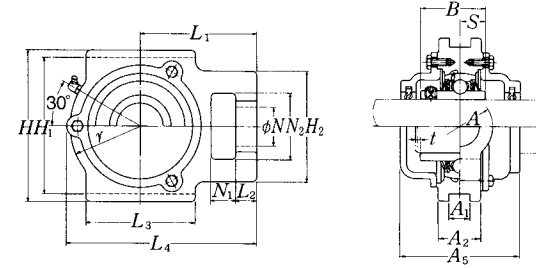
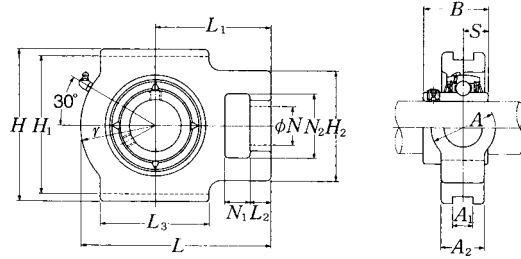

Cast dust cover type
Open end **C-UCT...D1**
Closed end **CM-UCT...D1**

Shaft dia. mm inch	Unit number (1)	Nominal dimensions															
		mm inch															
		N_1	L_2	H_2	N_2	N	L_3	A_1	H_1	H	L	A_2	A	r	L_1	B	S
55 2 2 1/16 2 1/8 2 3/16	UCT311D1 UCT311-200D1 UCT311-201D1 UCT311-202D1 UCT311-203D1	29	23	105	66	39	115	22	150	163	207	44	66	80	127	66	25
		1 5/32	29/32	4 1/8	2 19/32	1 17/32	4 17/32	0.866	5 29/32	6 13/32	8 5/32	1 23/32	2 19/32	3 5/32	5	2.5984	0.984
60 2 1/4 2 5/16 2 3/8 2 7/16	UCT312D1 UCT312-204D1 UCT312-205D1 UCT312-206D1 UCT312-207D1	31	25	113	71	41	123	22	160	178	220	46	71	85	135	71	26
		1 7/32	31/32	4 7/16	2 25/32	1 5/8	4 27/32	0.866	6 19/64	7	8 21/32	1 13/16	2 25/32	3 11/32	5 9/16	2.7953	1.024
65 2 1/2 2 5/16	UCT313D1 UCT313-208D1 UCT313-209D1	32	27	116	70	43	134	26	170	190	238	50	80	92	146	75	30
		1 1/4	1 1/16	4 9/16	2 3/4	1 11/16	5 9/32	1.024	6 11/16	7 15/32	9 3/8	1 31/32	3 5/32	3 5/8	5 3/4	2.9528	1.181
70 2 5/8 2 11/16 2 3/4	UCT314D1 UCT314-210D1 UCT314-211D1 UCT314-212D1	36	27	130	85	46	140	26	180	202	252	52	90	97	155	78	33
		1 13/32	1 1/16	5 1/8	3 11/32	1 13/16	5 1/2	1.024	7 3/32	7 15/16	9 29/32	2 1/16	3 17/32	3 13/16	6 3/32	3.0709	1.299
75 2 3/16 2 7/8 2 5/16 3	UCT315D1 UCT315-213D1 UCT315-214D1 UCT315-215D1 UCT315-300D1	36	27	132	85	46	150	26	192	216	262	55	90	102	160	82	32
		1 13/32	1 1/16	5 3/16	3 11/32	1 13/16	5 29/32	1.024	7 9/16	8 1/2	10 5/16	2 5/32	3 17/32	4 1/32	6 5/16	3.2283	1.260
80 3 1/16 3 1/8 3 3/16	UCT316D1 UCT316-301D1 UCT316-302D1 UCT316-303D1	42	30	150	98	53	160	30	204	230	282	60	102	108	174	86	34
		1 21/32	1 3/16	5 29/32	3 27/32	2 3/32	6 5/16	1.181	8 1/32	9 1/16	11 3/32	2 3/8	4 1/32	4 1/4	6 27/32	3.3858	1.339

Note (1) These numbers indicate relubricatable type. If maintenance free type is needed, please order without suffix "D1".
Remarks Please refer to page A21 for size of grease fitting.

Bearing number	Housing number	Unit number (1) cast dust cover type	Nominal dimensions			Mass of unit	
			mm inch			kg lb	
			t max.	L_4	A_5	UCT	C(CM)
UC311D1	T311D1	C(CM)-UCT311D1	4	211	125	6.3	8.4
UC311-200D1	T311D1	C(CM)-UCT311-200D1					
UC311-201D1	T311D1	C(CM)-UCT311-201D1					
UC311-202D1	T311D1	C(CM)-UCT311-202D1	5/32	8 5/16	4 29/32	14	19
UC311-203D1	T311D1	C(CM)-UCT311-203D1					
UC312D1	T312D1	C(CM)-UCT312D1	4	227	135	7.6	10
UC312-204D1	T312D1	C(CM)-UCT312-204D1					
UC312-205D1	T312D1	C(CM)-UCT312-205D1					
UC312-206D1	T312D1	C(CM)-UCT312-206D1	5/32	8 15/16	5 5/16	17	22
UC312-207D1	T312D1	C(CM)-UCT312-207D1					
UC313D1	T313D1	C(CM)-UCT313D1	4	244	140	9.4	12
UC313-208D1	T313D1	C(CM)-UCT313-208D1					
UC313-209D1	T313D1	C(CM)-UCT313-209D1	5/32	9 19/32	5 1/2	21	26
UC314D1	T314D1	C(CM)-UCT314D1	4	258	140	11	14
UC314-210D1	T314D1	C(CM)-UCT314-210D1					
UC314-211D1	T314D1	C(CM)-UCT314-211D1					
UC314-212D1	T314D1	C(CM)-UCT314-212D1	5/32	10 5/32	5 1/2	24	31
UC315D1	T315D1	C(CM)-UCT315D1	4	268	150	13	17
UC315-213D1	T315D1	C(CM)-UCT315-213D1					
UC315-214D1	T315D1	C(CM)-UCT315-214D1					
UC315-215D1	T315D1	C(CM)-UCT315-215D1	5/32	10 9/16	5 29/32	29	37
UC315-300D1	T315D1	C(CM)-UCT315-300D1					
UC316D1	T316D1	C(CM)-UCT316D1	4	287	155	16	20
UC316-301D1	T316D1	C(CM)-UCT316-301D1					
UC316-302D1	T316D1	C(CM)-UCT316-302D1					
UC316-303D1	T316D1	C(CM)-UCT316-303D1	5/32	11 5/16	6 3/32	35	44

UCT3

Take-up unit, cast housing Set screw type

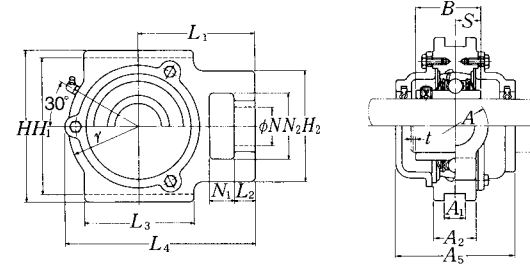
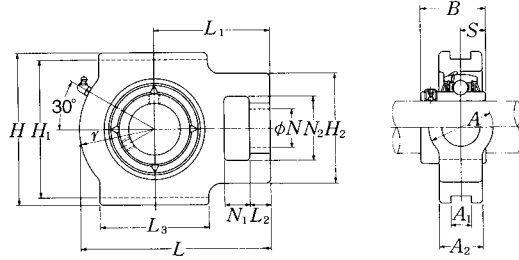

Cast dust cover type
Open end **C-UCT...D1**
Closed end **CM-UCT...D1**

Shaft dia. mm inch	Unit number (1)	Nominal dimensions															
		mm inch															
		N_1	L_2	H_2	N_2	N	L_3	A_1	H_1	H	L	A_2	A	r	L_1	B	S
85 3 1/4 3 5/16 3 7/16	UCT317D1 UCT317-304D1 UCT317-305D1 UCT317-307D1	42	32	152	98	53	170	32	214	240	298	64	102	115	183	96	40
		1 21/32	1 1/4	5 31/32	3 27/32	2 3/32	6 11/16	1.260	8 27/64	9 7/16	11 23/32	2 17/32	4 1/2	4 17/32	7 7/32	3.7795	1.575
90 3 7/16 3 1/2	UCT318D1 UCT318-307D1 UCT318-308D1	46	32	160	106	57	175	32	228	255	312	66	110	120	192	96	40
		1 13/16	1 1/4	6 5/16	4 3/16	2 1/4	6 7/8	1.260	8 31/32	10 1/32	12 9/32	2 19/32	4 11/32	4 29/32	7 9/16	3.7795	1.575
95 3 5/8 3 11/16 3 3/4	UCT319D1 UCT319-310D1 UCT319-311D1 UCT319-312D1	46	33	165	106	57	180	35	240	270	322	72	110	125	197	103	41
		1 13/16	1 5/16	6 1/2	4 3/16	2 1/4	7 3/32	1.378	9 29/64	10 5/8	12 11/16	2 27/32	4 11/32	4 29/32	7 3/4	4.0551	1.614
100 3 13/16 3 7/8 3 15/16 4	UCT320D1 UCT320-313D1 UCT320-314D1 UCT320-315D1 UCT320-400D1	48	34	175	115	59	200	35	260	290	345	75	120	135	210	108	42
		1 7/8	1 11/32	6 7/8	4 17/32	2 5/16	7 7/8	1.378	10 15/64	11 13/32	13 19/32	2 15/16	4 23/32	5 5/16	8 9/32	4.2520	1.654
105	UCT321D1	48	34	175	115	59	200	35	260	290	347	75	120	135	212	112	44
110	UCT322D1	52	40	185	125	65	215	38	285	320	385	80	130	150	235	117	46
120	UCT324D1	60	44	210	140	70	230	45	320	355	432	90	140	165	267	126	51
130	UCT326D1	65	47	220	150	75	240	50	350	385	465	100	150	180	285	135	54
140	UCT328D1	70	52	230	160	80	255	50	380	415	515	100	155	200	315	145	59

Note (1) These numbers indicate relubricatable type. If maintenance free type is needed, please order without suffix "D1".
Remarks Please refer to page A21 for size of grease fitting.

Bearing number	Housing number	Unit number (1) cast dust cover type	Nominal dimensions			Mass of unit	
			mm inch			kg lb	
			t max.	L_4	A_3	UCT	C(CM)
UC317D1	T317D1	C(CM)-UCT317D1	5	303	170	19	25
UC317-304D1	T317D1	C(CM)-UCT317-304D1					
UC317-305D1	T317D1	C(CM)-UCT317-305D1	13/64	11 15/16	6 11/16	42	55
UC317-307D1	T317D1	C(CM)-UCT317-307D1					
UC318D1	T318D1	C(CM)-UCT318D1	5	317	170	21	27
UC318-307D1	T318D1	C(CM)-UCT318-307D1					
UC318-308D1	T318D1	C(CM)-UCT318-308D1	13/64	12 15/32	6 11/16	46	60
UC319D1	T319D1	C(CM)-UCT319D1	5	327	180	24	31
UC319-310D1	T319D1	C(CM)-UCT319-310D1					
UC319-311D1	T319D1	C(CM)-UCT319-311D1	13/64	12 7/8	7 3/32	53	68
UC319-312D1	T319D1	C(CM)-UCT319-312D1					
UC320D1	T320D1	C(CM)-UCT320D1	5	350	190	30	38
UC320-313D1	T320D1	C(CM)-UCT320-313D1					
UC320-314D1	T320D1	C(CM)-UCT320-314D1					
UC320-315D1	T320D1	C(CM)-UCT320-315D1	13/64	13 25/32	7 15/32	66	84
UC320-400D1	T320D1	C(CM)-UCT320-400D1					
UC321D1	T321D1	C(CM)-UCT321D1	5	359	195	32	43
UC322D1	T322D1	C(CM)-UCT322D1	5	395	200	40	55
UC324D1	T324D1	C(CM)-UCT324D1	5	439	215	55	71
UC326D1	T326D1	C(CM)-UCT326D1	6	476	225	69	92
UC328D1	T328D1	C(CM)-UCT328D1	6	519	235	84	111

Take-up unit, cast housing Set screw type

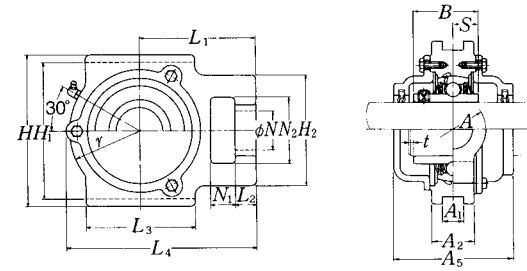
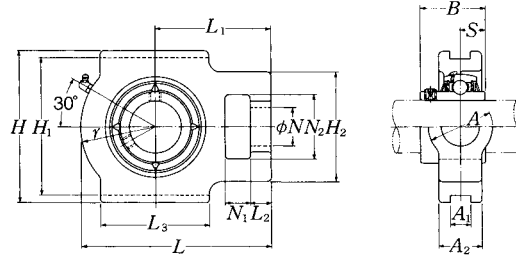

Cast dust cover type
Open end **C-UCT...D1**
Closed end **CM-UCT...D1**

Shaft dia. mm inch	Unit number (1)	Nominal dimensions															
		mm inch															
		N_1	L_2	H_2	N_2	N	L_3	A_1	H_1	H	L	A_2	A	r	L_1	B	S
25 1 13/16 7/8 15/16 1	UCTX05D1 UCTX05-013D1 UCTX05-014D1 UCTX05-015D1 UCTX05-100D1	16	12	56	37	22	57	12	89	102	113	28	37	43	70	38.1	15.9
		5/8	15/32	2 7/32	1 15/32	7/8	2 1/4	0.472	3 1/2	4 1/32	4 7/16	1 3/32	1 15/32	1 11/16	2 3/4	1.5000	0.626
30 1 1/16 1 1/8 1 3/16 1 1/4	UCTX06D1 UCTX06-101D1 UCTX06-102D1 UCTX06-103D1 UCTX06-104D1	16	15	64	37	22	64	12	89	102	129	30	37	51	78	42.9	17.5
		5/8	19/32	2 17/32	1 15/32	7/8	2 17/32	0.472	3 1/2	4 1/32	5 3/32	1 3/16	1 15/32	2	3 1/16	1.6890	0.689
35 1 5/16 1 3/8 1 7/16	UCTX07D1 UCTX07-105D1 UCTX07-106D1 UCTX07-107D1	19	17	83	49	29	83	16	102	114	144	36	49	56	88	49.2	19
		3/4	21/32	3 9/32	1 15/16	1 5/32	3 9/32	0.630	4 1/64	4 1/2	5 21/32	1 13/32	1 15/16	2 7/32	3 5/32	1.9370	0.748
40 1 1/2 1 9/16	UCTX08D1 UCTX08-108D1 UCTX08-109D1	19	17	83	49	29	83	16	102	117	144	36	49	57	87	49.2	19
		3/4	21/32	3 9/32	1 15/16	1 5/32	3 9/32	0.630	4 1/64	4 19/32	5 21/32	1 13/32	1 15/16	2 1/4	3 7/16	1.9370	0.748
45 1 5/8 1 11/16 1 3/4 1 13/16	UCTX09D1 UCTX09-110D1 UCTX09-111D1 UCTX09-112D1 UCTX09-113D1	19	18	83	49	29	86	16	102	117	151	38	49	59	92	51.6	19
		3/4	23/32	3 9/32	1 15/16	1 5/32	3 3/8	0.630	4 1/64	4 19/32	5 15/16	1 1/2	1 15/16	2 5/16	3 5/8	2.0315	0.748
50 1 7/8 1 15/16 2	UCTX10D1 UCTX10-114D1 UCTX10-115D1 UCTX10-200D1	25	21	102	64	35	95	22	130	146	171	42	64	65	106	55.6	22.2
		31/32	13/16	4 1/32	2 17/32	1 3/8	3 3/4	0.866	5 1/8	5 3/4	6 23/32	1 21/32	2 17/32	2 9/16	4 3/16	2.1890	0.874

Note (1) These numbers indicate relubricatable type. If maintenance free type is needed, please order without suffix "D1".

Remarks Please refer to page A21 for size of grease fitting.

Bearing number	Housing number	Unit number (1) cast dust cover type	Nominal dimensions			Mass of unit	
			mm inch			kg lb	
			t max.	L_4	A_5	UCT	C(CM)
UCX05D1 UCX05-013D1 UCX05-014D1 UCX05-015D1 UCX05-100D1	TX05D1 TX05D1 TX05D1 TX05D1 TX05D1	C(CM)-UCTX05D1 C(CM)-UCTX05-013D1 C(CM)-UCTX05-014D1 C(CM)-UCTX05-015D1 C(CM)-UCTX05-100D1	2 5/64	113.5 4 15/32	75 2 15/16	1.4 3.1	1.8 4.0
UCX06D1 UCX06-101D1 UCX06-102D1 UCX06-103D1 UC207-104D1	TX06D1 TX06D1 TX06D1 TX06D1 TX06D1	C(CM)-UCTX06D1 C(CM)-UCTX06-101D1 C(CM)-UCTX06-102D1 C(CM)-UCTX06-103D1 C(CM)-UCTX06-104D1	2 5/64	129 5 3/32	80 3 5/32	1.8 4.0	2.3 5.1
UCX07D1 UCX07-105D1 UCX07-106D1 UCX07-107D1	TX07D1 TX07D1 TX07D1 TX07D1	C(CM)-UCTX07D1 C(CM)-UCTX07-105D1 C(CM)-UCTX07-106D1 C(CM)-UCTX07-107D1	3 1/8	144 5 21/32	90 3 17/32	2.6 5.7	3.5 7.7
UCX08D1 UCX08-108D1 UCX08-109D1	TX08D1 TX08D1 TX08D1	C(CM)-UCTX08D1 C(CM)-UCTX08-108D1 C(CM)-UCTX08-109D1	3 1/8	144.5 5 11/16	95 3 3/4	2.6 5.7	3.5 7.7
UCX09D1 UCX09-110D1 UCX09-111D1 UCX09-112D1 UC210-113D1	TX09D1 TX09D1 TX09D1 TX09D1 TX09D1	C(CM)-UCTX09D1 C(CM)-UCTX09-110D1 C(CM)-UCTX09-111D1 C(CM)-UCTX09-112D1 C(CM)-UCTX09-113D1	3 1/8	152 5 31/32	100 3 15/16	2.7 6.0	3.7 8.2
UCX10D1 UCX10-114D1 UCX10-115D1 UC211-200D1	TX10D1 TX10D1 TX10D1 TX10D1	C(CM)-UCTX10D1 C(CM)-UCTX10-114D1 C(CM)-UCTX10-115D1 C(CM)-UCTX10-200D1	3 1/8	171.5 6 3/4	100 3 15/16	4.2 9.3	5.4 12

Take-up unit, cast housing Set screw type

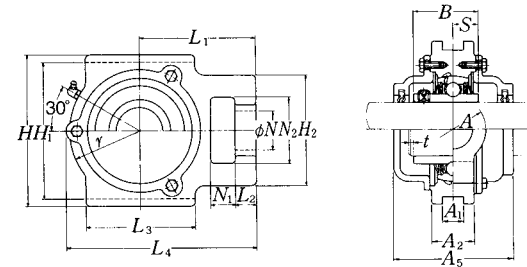
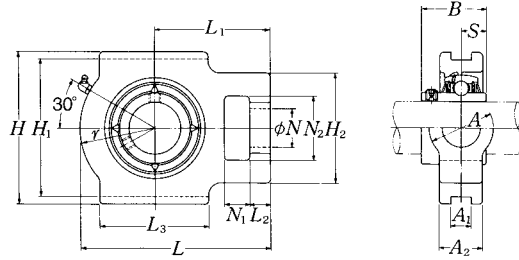

Cast dust cover type
Open end **C-UCT...D1**
Closed end **CM-UCT...D1**

Shaft dia. mm inch	Unit number (1)	Nominal dimensions															
		mm inch															
		N_1	L_2	H_2	N_2	N	L_3	A_1	H_1	H	L	A_2	A	r	L_1	B	S
55 2 1/16 2 1/8 2 3/16 2 1/4 2 5/16	UCTX11D1 UCTX11-201D1 UCTX11-202D1 UCTX11-203D1 UCTX11-204D1 UCTX11-205D1	32	21	102	64	35	102	22	130	146	194	44	64	75	119	65.1	25.4
60 2 3/8 2 7/16	UCTX12D1 UCTX12-206D1 UCTX12-207D1	32	23	111	70	41	121	26	151	167	224	48	70	87	137	65.1	25.4
65 2 1/2 2 5/8	UCTX13D1 UCTX13-208D1 UCTX13-209D1	32	23	111	70	41	121	26	151	167	224	48	70	87	137	74.6	30.2
70 2 5/8 2 11/16 2 3/4	UCTX14D1 UCTX14-210D1 UCTX14-211D1 UCTX14-212D1	32	23	111	70	41	121	26	151	167	232	48	70	92	140	77.8	33.3
75 2 13/16 2 7/8 2 15/16 3	UCTX15D1 UCTX15-213D1 UCTX15-214D1 UCTX15-215D1 UCTX15-300D1	32	23	111	70	41	121	28	165	184	235	48	70	95	140	82.6	33.3
80 3 1/16 3 1/8 3 3/16 3 1/4	UCTX16D1 UCTX16-301D1 UCTX16-302D1 UCTX16-303D1 UCTX16-304D1	38	30	124	73	48	157	28	173	198	260	54	73	98	162	85.7	34.1
85 3 5/16 3 7/16	UCTX17D1 UCTX17-305D1 UCTX17-307D1	38	30	124	73	48	157	28	173	198	260	54	73	98	162	96	39.7

Note (1) These numbers indicate relubricatable type. If maintenance free type is needed, please order without suffix "D1".

Remarks Please refer to page A21 for size of grease fitting.

Bearing number	Housing number	Unit number (1) cast dust cover type	Nominal dimensions			Mass of unit	
			mm inch			kg lb	
			t max.	L_4	A_5	UCT	C(CM)
UCX11D1 UCX11-201D1 UCX11-202D1 UCX11-203D1 UC212-204D1 UC212-205D1	TX11D1 TX11D1 TX11D1 TX11D1 TX11D1 TX11D1	C(CM)-UCTX11D1 C(CM)-UCTX11-201D1 C(CM)-UCTX11-202D1 C(CM)-UCTX11-203D1 C(CM)-UCTX11-204D1 C(CM)-UCTX11-205D1	4 5/32	194 7 5/8	115 4 17/32	5.2 11	6.7 15
UCX12D1 UCX12-206D1 UCX12-207D1	TX12D1 TX12D1 TX12D1	C(CM)-UCTX12D1 C(CM)-UCTX12-206D1 C(CM)-UCTX12-207D1	4 5/32	224 8 13/16	120 4 23/32	7.2 16	9.0 20
UCX13D1 UCX13-208D1 UCX13-209D1	TX13D1 TX13D1 TX13D1	C(CM)-UCTX13D1 C(CM)-UCTX13-208D1 C(CM)-UCTX13-209D1	4 5/32	224 8 13/16	135 5 5/16	7.5 17	9.8 22
UCX14D1 UCX14-210D1 UCX14-211D1 UCX14-212D1	TX14D1 TX14D1 TX14D1 TX14D1	C(CM)-UCTX14D1 C(CM)-UCTX14-210D1 C(CM)-UCTX14-211D1 C(CM)-UCTX14-212D1	4 5/32	232 9 1/8	135 5 5/16	7.7 17	10 22
UCX15D1 UCX15-213D1 UCX15-214D1 UCX15-215D1 UCX15-300D1	TX15D1 TX15D1 TX15D1 TX15D1 TX15D1	C(CM)-UCTX15D1 C(CM)-UCTX15-213D1 C(CM)-UCTX15-214D1 C(CM)-UCTX15-215D1 C(CM)-UCTX15-300D1	4 5/32	235 9 1/4	145 5 23/32	8.3 18	11 24
UCX16D1 UCX16-301D1 UCX16-302D1 UCX16-303D1 UC217-304D1	TX16D1 TX16D1 TX16D1 TX16D1 TX16D1	C(CM)-UCTX16D1 C(CM)-UCTX16-301D1 C(CM)-UCTX16-302D1 C(CM)-UCTX16-303D1 C(CM)-UCTX16-304D1	4 5/32	260 10 1/4	155 6 3/32	11 24	14 31
UCX17D1 UCX17-305D1 UCX17-307D1	TX17D1 TX17D1 TX17D1	C(CM)-UCTX17D1 C(CM)-UCTX17-305D1 C(CM)-UCTX17-307D1	5 13/64	262 10 5/16	165 6 1/2	11 24	15 33

Take-up stretcher units™ Set screw type

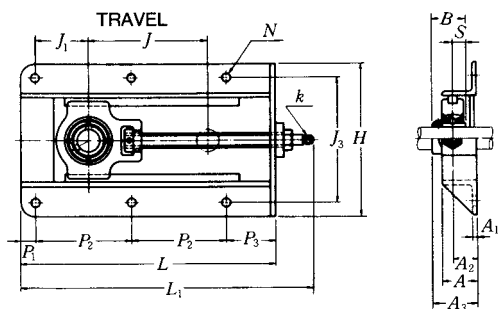

Shaft dia. mm	Unit number ⁽¹⁾	Nominal dimensions																
		mm																
		L	H	J	J ₁	J ₃	A ₁	A ₂	A	P ₁	P ₂	P ₃	N	L ₁	A ₃	B	S	k square
12	UCT201-15	317	199	150	69	154	6	30	50	19	117	64	12	370	48.3	31	12.7	9
15	UCT202-15	317	199	150	69	154	6	30	50	19	117	64	12	370	48.3	31	12.7	9
17	UCT203-15	317	199	150	69	154	6	30	50	19	117	64	12	370	48.3	31	12.7	9
20	UCT204-15	317	199	150	69	154	6	30	50	19	117	64	12	370	48.3	31	12.7	9
25	UCT205-15	317	199	150	68	154	6	30	50	19	117	64	12	370	49.8	34.1	14.3	9
30	UCT206-15	337	212	150	73	166	6	32	50	19	127	64	12	393	54.2	38.1	15.9	10
35	UCT207-23	429	212	230	80	166	6	32	50	19	173	64	12	485	57.4	42.9	17.5	10
40	UCT208-30	520	233	300	88	192	6	32	50	22	217	64	12	596	62.2	49.2	19	15
45	UCT209-30	520	233	300	88	192	6	32	50	22	217	64	12	596	62.2	49.2	19	15
50	UCT210-30	524	233	300	92	192	6	35	50	22	219	64	15	599	67.6	51.6	19	15
55	UCT211-30	542	285	300	93	240	8	38	65	22	230	60	15	630	71.4	55.6	22.2	17
60	UCT212-30	568	285	300	103	240	8	38	65	22	243	60	15	657	77.7	65.1	25.4	17
65	UCT213-30	606	306	300	125	260	8	43	65	22	260	64	15	705	82.7	65.1	25.4	23

Notes ⁽¹⁾ If relubricatable type is needed, please order with suffix "D1".

⁽²⁾ The Stretcher Units is designed to only take a horizontal radial load, in line with the adjustment direction. Axial loads or vertical radial loads can deform or break the housing.

Adjustment screw size	Bolt size	Max. load ⁽²⁾ recommended N	Bearing number	Mass of unit kg
TM16 × 3	M10	7 650	UC201D1	5.0
TM16 × 3	M10	7 650	UC202D1	5.0
TM16 × 3	M10	7 650	UC203D1	5.0
TM16 × 3	M10	7 650	UC204D1	5.0
TM16 × 3	M10	7 850	UC205D1	5.0
TM18 × 4	M10	9 810	UC206D1	5.7
TM18 × 4	M10	12 750	UC207D1	6.8
TM25 × 5	M10	15 690	UC208D1	11
TM25 × 5	M10	15 690	UC209D1	11
TM25 × 5	M12	16 670	UC210D1	11
TM30 × 6	M12	19 610	UC211D1	18
TM30 × 6	M12	21 570	UC212D1	20
TM30 × 6	M12	23 530	UC213D1	23

Take-up type L stretcher units™ Set screw type

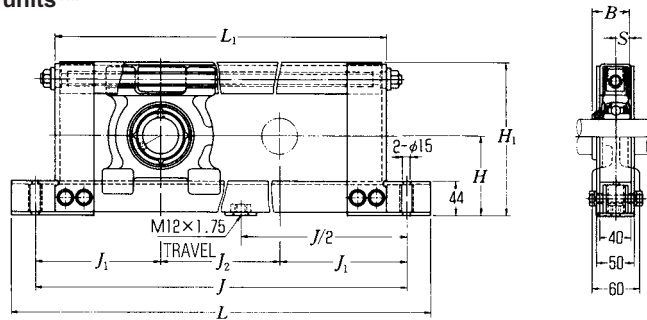

Shaft dia. mm	Unit number ⁽¹⁾	Nominal dimensions									Bolt size	Max. load ⁽²⁾ recommended N
		H	L	J	J ₂	mm		H ₁	B	S		
20	UCL204-10	77	430	370	100	320	135	146	31	12.7	M12	1 960
	UCL204-20	77	530	470	200	420	135	146	31	12.7	M12	1 960
	UCL204-30	77	630	570	300	520	135	146	31	12.7	M12	1 960
	UCL204-40	77	730	670	400	620	135	146	31	12.7	M12	1 960
25	UCL205-10	82	440	380	100	330	140	156	34.1	14.3	M12	2 250
	UCL205-20	82	540	480	200	430	140	156	34.1	14.3	M12	2 250
	UCL205-30	82	640	580	300	530	140	156	34.1	14.3	M12	2 250
	UCL205-40	82	740	680	400	630	140	156	34.1	14.3	M12	2 250
30	UCL206-10	87	450	390	100	340	145	166	38.1	15.9	M12	3 230
	UCL206-20	87	550	490	200	440	145	166	38.1	15.9	M12	3 230
	UCL206-30	87	650	590	300	540	145	166	38.1	15.9	M12	3 230
	UCL206-40	87	750	690	400	640	145	166	38.1	15.9	M12	3 230
35	UCL207-10	92	460	400	100	350	150	176	42.9	17.5	M12	4 210
	UCL207-20	92	560	500	200	450	150	176	42.9	17.5	M12	4 210
	UCL207-30	92	660	600	300	550	150	176	42.9	17.5	M12	4 210
	UCL207-40	92	760	700	400	650	150	176	42.9	17.5	M12	4 210
40	UCL208-10	97	470	410	100	360	155	186	49.2	19	M12	4 500
	UCL208-20	97	570	510	200	460	155	186	49.2	19	M12	4 500
	UCL208-30	97	670	610	300	560	155	186	49.2	19	M12	4 500
	UCL208-40	97	770	710	400	660	155	186	49.2	19	M12	4 500
45	UCL209-10	100	480	420	100	370	160	192	49.2	19	M12	4 500
	UCL209-20	100	580	520	200	470	160	192	49.2	19	M12	4 500
	UCL209-30	100	680	620	300	570	160	192	49.2	19	M12	4 500
	UCL209-40	100	780	720	400	670	160	192	49.2	19	M12	4 500

Bearing number	Mass of unit kg
UC204D1	6.3
UC204D1	7.0
UC204D1	7.7
UC204D1	8.4
UC205D1	6.8
UC205D1	7.5
UC205D1	8.2
UC205D1	8.9
UC206D1	7.3
UC206D1	8.0
UC206D1	8.7
UC206D1	9.4
UC207D1	7.8
UC207D1	8.5
UC207D1	9.2
UC207D1	9.9
UC208D1	8.3
UC208D1	9.0
UC208D1	9.7
UC208D1	10
UC209D1	8.7
UC209D1	9.4
UC209D1	10
UC209D1	11

Notes ⁽¹⁾ If relubricatable type is needed, please order with suffix "D1".

⁽²⁾ The Stretcher Units is designed to only take a horizontal radial load, in line with the adjustment direction. Axial loads or vertical radial loads can deform or break the housing.

Take-up type M stretcher units™ Set screw type

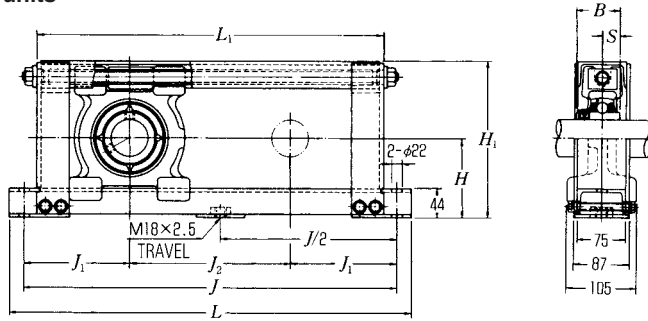

Shaft dia. mm	Unit number ⁽¹⁾	Nominal dimensions mm								Bolt size	Max. load ⁽²⁾ recommended N	
		H	L	J	J ₂	L ₁	J ₁	H ₁	B			S
40	UCM208-50	97	870	810	500	760	155	190	49.2	19	M18	5 190
	UCM208-60	97	970	910	600	860	155	190	49.2	19	M18	5 190
	UCM208-70	97	1070	1010	700	960	155	190	49.2	19	M18	5 190
	UCM208-80	97	1170	1110	800	1060	155	190	49.2	19	M18	5 190
	UCM208-90	97	1270	1210	900	1160	155	190	49.2	19	M18	5 190
45	UCM209-50	102	880	820	500	770	160	200	49.2	19	M18	5 880
	UCM209-60	102	980	920	600	870	160	200	49.2	19	M18	5 880
	UCM209-70	102	1080	1020	700	970	160	200	49.2	19	M18	5 880
	UCM209-80	102	1180	1120	800	1070	160	200	49.2	19	M18	5 880
	UCM209-90	102	1280	1220	900	1170	160	200	49.2	19	M18	5 880
50	UCM210-50	107	890	830	500	780	165	210	51.6	19	M18	6 460
	UCM210-60	107	990	930	600	880	165	210	51.6	19	M18	6 460
	UCM210-70	107	1090	1030	700	980	165	210	51.6	19	M18	6 460
	UCM210-80	107	1190	1130	800	1080	165	210	51.6	19	M18	6 460
	UCM210-90	107	1290	1230	900	1180	165	210	51.6	19	M18	6 460
55	UCM211-50	115	910	850	500	800	175	230	55.6	22.2	M18	6 460
	UCM211-60	115	1010	950	600	900	175	230	55.6	22.2	M18	6 460
	UCM211-70	115	1110	1050	700	1000	175	230	55.6	22.2	M18	6 460
	UCM211-80	115	1210	1150	800	1100	175	230	55.6	22.2	M18	6 460
	UCM211-90	115	1310	1250	900	1200	175	230	55.6	22.2	M18	6 460
60	UCM212-50	120	920	860	500	810	180	240	65.1	25.4	M18	6 460
	UCM212-60	120	1020	960	600	910	180	240	65.1	25.4	M18	6 460
	UCM212-70	120	1120	1060	700	1010	180	240	65.1	25.4	M18	6 460
	UCM212-80	120	1220	1160	800	1110	180	240	65.1	25.4	M18	6 460
	UCM212-90	120	1320	1260	900	1210	180	240	65.1	25.4	M18	6 460
65	UCM213-50	125	940	880	500	830	190	250	65.1	25.4	M18	6 460
	UCM213-60	125	1040	980	600	930	190	250	65.1	25.4	M18	6 460
	UCM213-70	125	1140	1080	700	1030	190	250	65.1	25.4	M18	6 460
	UCM213-80	125	1240	1180	800	1130	190	250	65.1	25.4	M18	6 460
	UCM213-90	125	1340	1280	900	1230	190	250	65.1	25.4	M18	6 460

Bearing number	Mass of unit kg
UC208D1	20
UC208D1	22
UC208D1	23
UC208D1	24
UC208D1	30
UC209D1	21
UC209D1	23
UC209D1	24
UC209D1	30
UC209D1	32
UC210D1	23
UC210D1	24
UC210D1	30
UC210D1	32
UC210D1	33
UC211D1	25
UC211D1	27
UC211D1	32
UC211D1	34
UC211D1	36
UC212D1	28
UC212D1	29
UC212D1	35
UC212D1	36
UC212D1	38
UC213D1	30
UC213D1	31
UC213D1	36
UC213D1	38
UC213D1	40

Notes ⁽¹⁾ If relubricatable type is needed, please order with suffix "D1".

⁽²⁾ The Stretcher Units is designed to only take a horizontal radial load, in line with the adjustment direction. Axial loads or vertical radial loads can deform or break the housing.

Take-up type M stretcher units™
Set screw type

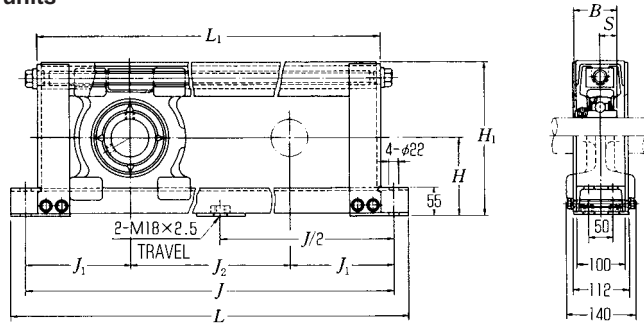

Shaft dia. mm	Unit number (¹)	Nominal dimensions mm									Bolt size	Max. load (²) recommended N	Bearing number	Mass of unit kg
		H	L	J	J ₂	L ₁	J ₁	H ₁	B	S				
65	UCM313-50	145	940	880	500	830	190	285	75	30	M18	16 260	UC313D1	47
	UCM313-60	145	1040	980	600	930	190	285	75	30	M18	16 260	UC313D1	50
	UCM313-70	145	1140	1080	700	1030	190	285	75	30	M18	16 260	UC313D1	53
	UCM313-80	145	1240	1180	800	1130	190	285	75	30	M18	16 260	UC313D1	55
	UCM313-90	145	1340	1280	900	1230	190	285	75	30	M18	16 260	UC313D1	58
70	UCM314-50	150	960	900	500	850	200	295	78	33	M18	19 600	UC314D1	49
	UCM314-60	150	1060	1000	600	950	200	295	78	33	M18	19 600	UC314D1	52
	UCM314-70	150	1160	1100	700	1050	200	295	78	33	M18	19 600	UC314D1	55
	UCM314-80	150	1260	1200	800	1150	200	295	78	33	M18	19 600	UC314D1	58
	UCM314-90	150	1360	1300	900	1250	200	295	78	33	M18	19 600	UC314D1	61
75	UCM315-50	155	980	920	500	870	210	305	82	32	M18	19 600	UC315D1	52
	UCM315-60	155	1080	1020	600	970	210	305	82	32	M18	19 600	UC315D1	55
	UCM315-70	155	1180	1120	700	1070	210	305	82	32	M18	19 600	UC315D1	58
	UCM315-80	155	1280	1220	800	1170	210	305	82	32	M18	19 600	UC315D1	60
	UCM315-90	155	1380	1320	900	1270	210	305	82	32	M18	19 600	UC315D1	63
80	UCM316-50	160	1000	940	500	890	220	315	86	34	M18	19 600	UC316D1	54
	UCM316-60	160	1100	1040	600	990	220	315	86	34	M18	19 600	UC316D1	57
	UCM316-70	160	1200	1140	700	1090	220	315	86	34	M18	19 600	UC316D1	60
	UCM316-80	160	1300	1240	800	1190	220	315	86	34	M18	19 600	UC316D1	63
	UCM316-90	160	1400	1340	900	1290	220	315	86	34	M18	19 600	UC316D1	66
85	UCM317-50	165	1020	960	500	910	230	325	96	40	M18	19 600	UC317D1	60
	UCM317-60	165	1120	1060	600	1010	230	325	96	40	M18	19 600	UC317D1	63
	UCM317-70	165	1220	1160	700	1110	230	325	96	40	M18	19 600	UC317D1	65
	UCM317-80	165	1320	1260	800	1210	230	325	96	40	M18	19 600	UC317D1	68
	UCM317-90	165	1420	1360	900	1310	230	325	96	40	M18	19 600	UC317D1	71

Notes (¹) If relubricatable type is needed, please order with suffix "D1".
(²) The Stretcher Units is designed to only take a horizontal radial load, in line with the adjustment direction. Axial loads or vertical radial loads can deform or break the housing.

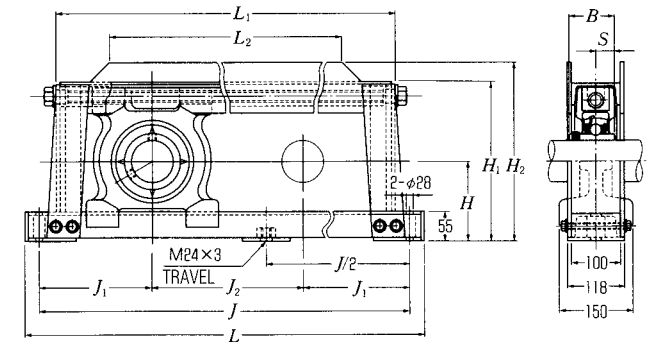

Shaft dia. mm	Unit number (¹)	Nominal dimensions mm											Bolt size	Max. load (²) recommended N	Bearing number	Mass of unit kg
		H	L	J	J ₂	L ₁	L ₂	J ₁	H ₁	H ₂	B	S				
90	UCM318-50	170	1050	990	500	940	—	245	335	—	96	40	M18	19 600	UC318D1	65
	UCM318-60	170	1150	1090	600	1040	—	245	335	—	96	40	M18	19 600	UC318D1	68
	UCM318-70	170	1250	1190	700	1140	—	245	335	—	96	40	M18	19 600	UC318D1	71
	UCM318-80	170	1350	1290	800	1240	—	245	335	—	96	40	M18	19 600	UC318D1	74
	UCM318-90	170	1450	1390	900	1340	—	245	335	—	96	40	M18	19 600	UC318D1	77
95	UCM319-50	185	1180	1100	500	1021	775	300	377	400	103	41	M24	19 600	UC319D1	105
	UCM319-60	185	1280	1200	600	1121	875	300	377	400	103	41	M24	19 600	UC319D1	109
	UCM319-70	185	1380	1300	700	1221	975	300	377	400	103	41	M24	19 600	UC319D1	112
	UCM319-80	185	1480	1400	800	1321	1075	300	377	400	103	41	M24	19 600	UC319D1	116
	UCM319-90	185	1580	1500	900	1421	1175	300	377	400	103	41	M24	19 600	UC319D1	120
100	UCM320-50	200	1220	1140	500	1063	809	320	403	430	108	42	M24	19 600	UC320D1	111
	UCM320-60	200	1320	1240	600	1163	909	320	403	430	108	42	M24	19 600	UC320D1	116
	UCM320-70	200	1420	1340	700	1263	1009	320	403	430	108	42	M24	19 600	UC320D1	120
	UCM320-80	200	1520	1440	800	1363	1109	320	403	430	108	42	M24	19 600	UC320D1	124
	UCM320-90	200	1620	1540	900	1463	1209	320	403	430	108	42	M24	19 600	UC320D1	129

Notes (¹) If relubricatable type is needed, please order with suffix "D1".
(²) The Stretcher Units is designed to only take a horizontal radial load, in line with the adjustment direction. Axial loads or vertical radial loads can deform or break the housing.

ASPT2 -

Take-up mini stretcher units™

Set screw type

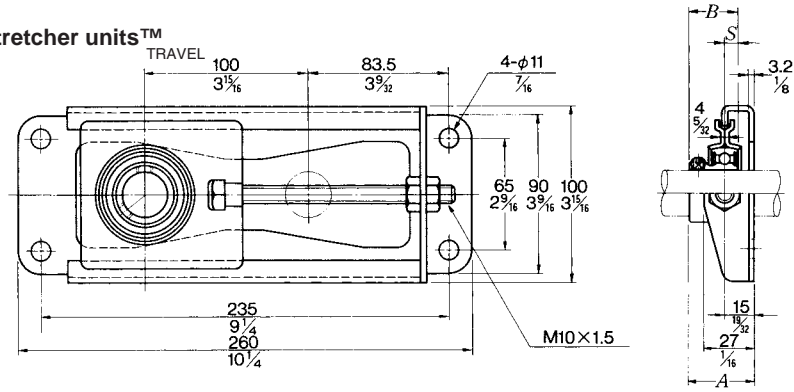

Shaft dia. mm inch	Unit number	Nominal dimensions			Bolt size mm inch	Max. load (1) recommended N lbf
		A	B	S		
12 1/2	ASPT201-10	31	22	6	M10	3 430
	ASPT201-008-10	1 7/32	0.8661	0.236	3/8	770
15 9/16 5/8	ASPT202-10	31	22	6	M10	3 430
	ASPT202-009-10 ASPT202-010-10	1 7/32	0.8661	0.236	3/8	770
17 11/16	ASPT203-10	31	22	6	M10	3 430
	ASPT203-011-10	1 7/32	0.8661	0.236	3/8	770
20 3/4	ASPT204-10	33	25	7	M10	3 430
	ASPT204-012-10	1 19/64	0.9843	0.276	3/8	770
25 13/16 7/8 15/16 1	ASPT205-10	34.5	27	7.5	M10	3 430
	ASPT205-013-10					
	ASPT205-014-10					
	ASPT205-015-10 ASPT205-100-10	1 23/64	1.0630	0.295	3/8	770

Note (1) The Stretcher Units is designed to only take a horizontal radial load, in line with the adjustment direction. Axial loads or vertical radial loads can deform or break the housing.

Bearing number	Mass of unit kg lb
AS201	1.1
AS201-008	2.4
AS202	1.1
AS202-009 AS202-010	2.4
AS203	1.1
AS203-011	2.4
AS204	1.1
AS204-012	2.4
AS205	1.1
AS205-013 AS205-014 AS205-015 AS205-100	2.4

Cartridge unit, cast housing Set screw type

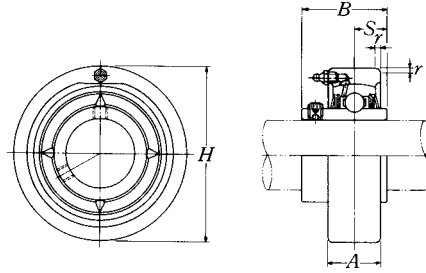

Shaft dia. mm inch	Unit number (1)	Nominal dimensions mm inch					Bearing number	Housing number	Mass of unit kg lb
		H	A	r	B	S			
12 1/2	UCC201D1	72	20	2	31	12.7	UC201D1	C204D1	0.5
	UCC201-008D1	2.8346	25/32	0.079	1.2205	0.500	UC201-008D1	C204D1	1.1
15 9/16 5/8	UCC202D1	72	20	2	31	12.7	UC202D1	C204D1	0.5
	UCC202-009D1 UCC202-010D1	2.8346	25/32	0.079	1.2205	0.500	UC202-009D1 UC202-010D1	C204D1 C204D1	1.1
17 11/16	UCC203D1	72	20	2	31	12.7	UC203D1	C204D1	0.5
	UCC203-011D1	2.8346	25/32	0.079	1.2205	0.500	UC203-011D1	C204D1	1.1
20 3/4	UCC204D1	72	20	2	31	12.7	UC204D1	C204D1	0.5
	UCC204-012D1	2.8346	25/32	0.079	1.2205	0.500	UC204-012D1	C204D1	1.1
25 13/16 7/8 15/16 1	UCC205D1	80	22	2	34.1	14.3	UC205D1	C205D1	0.6
	UCC205-013D1	3.1496	55/64	0.079	1.3425	0.563	UC205-013D1	C205D1	1.3
	UCC205-014D1						UC205-014D1	C205D1	
	UCC205-015D1						UC205-015D1	C205D1	
UCC205-100D1	UC205-100D1						C205D1		
30 1 1/16 1 1/8 1 3/16 1 1/4	UCC206D1	85	27	2	38.1	15.9	UC206D1	C206D1	0.8
	UCC206-101D1	3.3465	1 1/16	0.079	1.5000	0.626	UC206-101D1	C206D1	1.8
	UCC206-102D1						UC206-102D1	C206D1	
	UCC206-103D1						UC206-103D1	C206D1	
UCC206-104D1	UC206-104D1						C206D1		
35 1 1/4 1 5/16 1 3/8 1 1/2	UCC207D1	90	28	2	42.9	17.5	UC207D1	C207D1	0.9
	UCC207-104D1	3.5433	1 7/64	0.079	1.6890	0.689	UC207-104D1	C207D1	2.0
	UCC207-105D1						UC207-105D1	C207D1	
	UCC207-106D1						UC207-106D1	C207D1	
UCC207-107D1	UC207-107D1						C207D1		

Note (1) These numbers indicate relubricatable type. If maintenance free type is needed, please order without suffix "D1".
Remarks Please refer to page A21 for size of grease fitting.

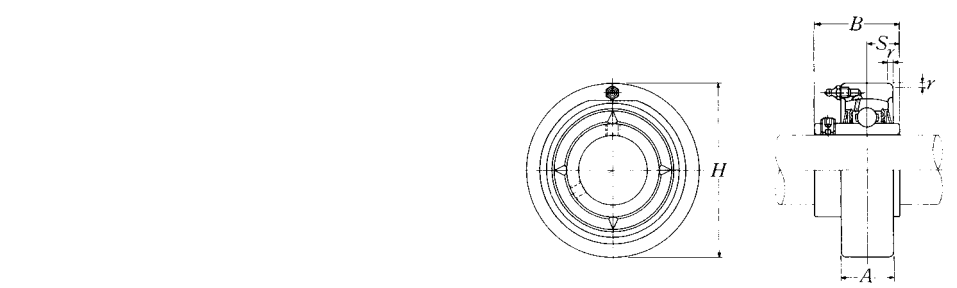

Shaft dia. mm inch	Unit number (1)	Nominal dimensions mm inch					Bearing number	Housing number	Mass of unit kg lb
		H	A	r	B	S			
40 1 1/2 1 9/16	UCC208D1	100	30	2.5	49.2	19	UC208D1	C208D1	1.2
	UCC208-108D1 UCC208-109D1	3.9370	1 3/16	0.098	1.9370	0.748	UC208-108D1 UC208-109D1	C208D1 C208D1	2.6
45 1 5/8 1 11/16 1 3/4	UCC209D1	110	31	2.5	49.2	19	UC209D1	C209D1	1.5
	UCC209-110D1 UCC209-111D1 UCC209-112D1	4.3307	1 7/32	0.098	1.9370	0.748	UC209-110D1 UC209-111D1 UC209-112D1	C209D1 C209D1 C209D1	3.3
50 1 13/16 1 7/8 1 15/16 2	UCC210D1	120	33	2.5	51.6	19	UC210D1	C210D1	1.9
	UCC210-113D1	4.7244	1 19/64	0.098	2.0315	0.748	UC210-113D1	C210D1	4.2
	UCC210-114D1						UC210-114D1	C210D1	
	UCC210-115D1						UC210-115D1	C210D1	
UCC210-200D1	UC210-200D1						C210D1		
55 2 2 1/16 2 1/8 2 3/16	UCC211D1	125	35	2.5	55.6	22.2	UC211D1	C211D1	2.1
	UCC211-200D1	4.9213	1 3/8	0.098	2.1890	0.874	UC211-200D1	C211D1	4.6
	UCC211-201D1						UC211-201D1	C211D1	
	UCC211-202D1						UC211-202D1	C211D1	
UCC211-203D1	UC211-203D1						C211D1		
60 2 1/4 2 5/16 2 3/8 2 7/16	UCC212D1	130	38	2.5	65.1	25.4	UC212D1	C212D1	2.5
	UCC212-204D1	5.1181	1 1/2	0.098	2.5630	1.000	UC212-204D1	C212D1	5.5
	UCC212-205D1						UC212-205D1	C212D1	
	UCC212-206D1						UC212-206D1	C212D1	
UCC212-207D1	UC212-207D1						C212D1		
65 2 1/2 2 9/16	UCC213D1	140	40	3	65.1	25.4	UC213D1	C213D1	3.0
	UCC213-208D1 UCC213-209D1	5.5118	1 37/64	0.118	2.5630	1.000	UC213-208D1 UC213-209D1	C213D1 C213D1	6.6

Note (1) These numbers indicate relubricatable type. If maintenance free type is needed, please order without suffix "D1".
Remarks Please refer to page A21 for size of grease fitting.

Cartridge unit, cast housing Set screw type

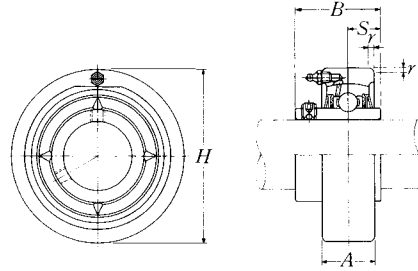

Shaft dia. mm inch	Unit number (1)	Nominal dimensions					Bearing number	Housing number	Mass of unit kg lb
		mm inch							
		H	A	r	B	S			
25	UCC305D1	90	26	2.5	38	15	UC305D1	C305D1	1.0
$\frac{13}{16}$	UCC305-013D1						UC305-013D1	C305D1	
$\frac{7}{8}$	UCC305-014D1	3.5433	$1\frac{1}{32}$	0.098	1.4961	0.591	UC305-014D1	C305D1	2.2
$\frac{15}{16}$	UCC305-015D1						UC305-015D1	C305D1	
1	UCC305-100D1						UC305-100D1	C305D1	
30	UCC306D1	100	28	2.5	43	17	UC306D1	C306D1	1.3
$1\frac{1}{16}$	UCC306-101D1						UC306-101D1	C306D1	
$1\frac{1}{8}$	UCC306-102D1	3.9370	$1\frac{7}{64}$	0.098	1.6929	0.669	UC306-102D1	C306D1	2.9
$1\frac{3}{16}$	UCC306-103D1						UC306-103D1	C306D1	
35	UCC307D1	110	32	3	48	19	UC307D1	C307D1	1.7
$1\frac{1}{4}$	UCC307-104D1						UC307-104D1	C307D1	
$1\frac{5}{16}$	UCC307-105D1	4.3307	$1\frac{17}{64}$	0.118	1.8898	0.748	UC307-105D1	C307D1	3.7
$1\frac{3}{8}$	UCC307-106D1						UC307-106D1	C307D1	
$1\frac{7}{16}$	UCC307-107D1						UC307-107D1	C307D1	
40	UCC308D1	120	34	3	52	19	UC308D1	C308D1	2.1
$1\frac{1}{2}$	UCC308-108D1						UC308-108D1	C308D1	
$1\frac{9}{16}$	UCC308-109D1	4.7244	$1\frac{11}{32}$	0.118	2.0472	0.748	UC308-109D1	C308D1	4.6
45	UCC309D1	130	38	3.5	57	22	UC309D1	C309D1	2.7
$1\frac{5}{8}$	UCC309-110D1						UC309-110D1	C309D1	
$1\frac{11}{16}$	UCC309-111D1	5.1181	$1\frac{1}{2}$	0.138	2.2441	0.866	UC309-111D1	C309D1	6.0
$1\frac{3}{4}$	UCC309-112D1						UC309-112D1	C309D1	
50	UCC310D1	140	40	3.5	61	22	UC310D1	C310D1	3.3
$1\frac{13}{16}$	UCC310-113D1						UC310-113D1	C310D1	
$1\frac{7}{8}$	UCC310-114D1	5.5118	$1\frac{37}{64}$	0.138	2.4016	0.866	UC310-114D1	C310D1	7.3
$1\frac{15}{16}$	UCC310-115D1						UC310-115D1	C310D1	

Note (1) These numbers indicate relubricatable type. If maintenance free type is needed, please order without suffix "D1".

Remarks Please refer to page A21 for size of grease fitting.

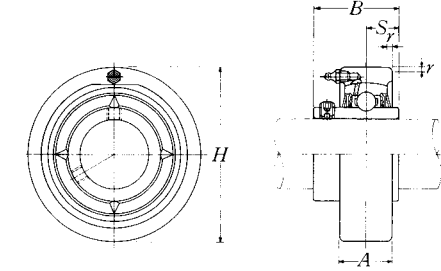

Shaft dia. mm inch	Unit number (1)	Nominal dimensions					Bearing number	Housing number	Mass of unit kg lb
		mm inch							
		H	A	r	B	S			
55	UCC311D1	150	44	3.5	66	25	UC311D1	C311D1	4.0
2	UCC311-200D1						UC311-200D1	C311D1	
$2\frac{1}{16}$	UCC311-201D1	5.9055	$1\frac{47}{64}$	0.138	2.5984	0.984	UC311-201D1	C311D1	8.8
$2\frac{1}{8}$	UCC311-202D1						UC311-202D1	C311D1	
$2\frac{3}{16}$	UCC311-203D1						UC311-203D1	C311D1	
60	UCC312D1	160	46	3.5	71	26	UC312D1	C312D1	4.8
$2\frac{1}{4}$	UCC312-204D1						UC312-204D1	C312D1	
$2\frac{5}{16}$	UCC312-205D1	6.2992	$1\frac{13}{16}$	0.138	2.7953	1.024	UC312-205D1	C312D1	11
$2\frac{3}{8}$	UCC312-206D1						UC312-206D1	C312D1	
$2\frac{7}{16}$	UCC312-207D1						UC312-207D1	C312D1	
65	UCC313D1	170	50	3.5	75	30	UC313D1	C313D1	5.8
$2\frac{1}{2}$	UCC313-208D1						UC313-208D1	C313D1	
$2\frac{9}{16}$	UCC313-209D1	6.6929	$1\frac{31}{32}$	0.138	2.9528	1.181	UC313-209D1	C313D1	13
70	UCC314D1	180	52	4	78	33	UC314D1	C314D1	6.8
$2\frac{5}{8}$	UCC314-210D1						UC314-210D1	C314D1	
$2\frac{11}{16}$	UCC314-211D1	7.0866	$2\frac{3}{64}$	0.157	3.0709	1.299	UC314-211D1	C314D1	15
$2\frac{3}{4}$	UCC314-212D1						UC314-212D1	C314D1	
75	UCC315D1	190	55	4	82	32	UC315D1	C315D1	7.9
$2\frac{13}{16}$	UCC315-213D1						UC315-213D1	C315D1	
$2\frac{7}{8}$	UCC315-214D1	7.4803	$2\frac{11}{64}$	0.157	3.2283	1.260	UC315-214D1	C315D1	17
$2\frac{15}{16}$	UCC315-215D1						UC315-215D1	C315D1	
3	UCC315-300D1						UC315-300D1	C315D1	
80	UCC316D1	200	60	4	86	34	UC316D1	C316D1	9.3
$3\frac{1}{16}$	UCC316-301D1						UC316-301D1	C316D1	
$3\frac{1}{8}$	UCC316-302D1	7.8740	$2\frac{23}{64}$	0.157	3.3858	1.339	UC316-302D1	C316D1	21
$3\frac{3}{16}$	UCC316-303D1						UC316-303D1	C316D1	

Note (1) These numbers indicate relubricatable type. If maintenance free type is needed, please order without suffix "D1".

Remarks Please refer to page A21 for size of grease fitting.

Cartridge unit, cast housing Set screw type

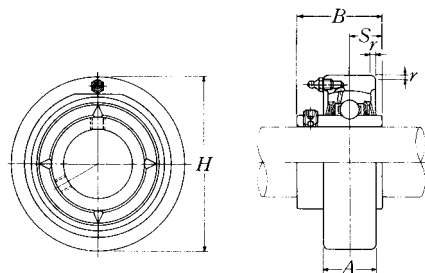

Shaft dia. mm inch	Unit number (1)	Nominal dimensions					Bearing number	Housing number	Mass of unit kg lb
		H	A	r	B	S			
85	UCC317D1	215	64	4	96	40	UC317D1	C317D1	11
3 1/4	UCC317-304D1	8.4646	2 33/64	0.157	3.7795	1.575	UC317-304D1	C317D1	24
3 5/16	UCC317-305D1						UC317-305D1	C317D1	
3 7/16	UCC317-307D1						UC317-307D1	C317D1	
90	UCC318D1	225	66	4	96	40	UC318D1	C318D1	13
3 1/2	UCC318-308D1	8.8583	2 19/32	0.157	3.7795	1.575	UC318-308D1	C318D1	29
95	UCC319D1	240	72	4	103	41	UC319D1	C319D1	16
3 5/8	UCC319-310D1	9.4488	2 53/64	0.157	4.0551	1.614	UC319-310D1	C319D1	35
3 11/16	UCC319-311D1						UC319-311D1	C319D1	
3 3/4	UCC319-312D1						UC319-312D1	C319D1	
100	UCC320D1	260	75	4	108	42	UC320D1	C320D1	20
3 13/16	UCC320-313D1	10.2362	2 61/64	0.157	4.2520	1.654	UC320-313D1	C320D1	44
3 7/8	UCC320-314D1						UC320-314D1	C320D1	
3 15/16	UCC320-315D1						UC320-315D1	C320D1	
4	UCC320-400D1						UC320-400D1	C320D1	
105	UCC321D1	260	75	4	112	44	UC321D1	C321D1	19
110	UCC322D1	300	80	5	117	46	UC322D1	C322D1	29
120	UCC324D1	320	90	5	126	51	UC324D1	C324D1	36
130	UCC326D1	340	100	5	135	54	UC326D1	C326D1	43
140	UCC328D1	360	100	5	145	59	UC328D1	C328D1	50

Note (1) These numbers indicate relubricatable type. If maintenance free type is needed, please order without suffix "D1".

Remarks Please refer to page **A21** for size of grease fitting.

Cartridge unit, cast housing Set screw type

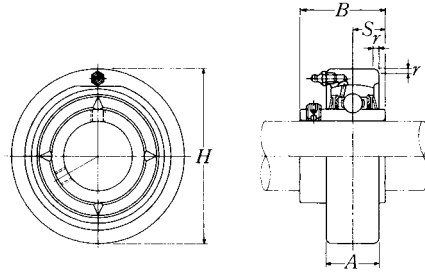

Shaft dia. mm inch	Unit number (1)	Nominal dimensions					Bearing number	Housing number	Mass of unit kg lb
		H	A	r	B	S			
25	UCCX05D1	90	27	2	38.1	15.9	UCX05D1	CX05D1	1.1
$\frac{13}{16}$	UCCX05-013D1	3.5433	$1\frac{1}{16}$	0.079	1.5000	0.626	UCX05-013D1	CX05D1	2.4
$\frac{7}{8}$	UCCX05-014D1						UCX05-014D1	CX05D1	
$\frac{15}{16}$	UCCX05-015D1						UCX05-015D1	CX05D1	
1	UCCX05-100D1						UCX05-100D1	CX05D1	
30	UCCX06D1	100	30	2.5	42.9	17.5	UCX06D1	CX06D1	1.6
$1\frac{1}{16}$	UCCX06-101D1	3.9370	$1\frac{3}{16}$	0.098	1.6890	0.689	UCX06-101D1	CX06D1	3.5
$1\frac{1}{8}$	UCCX06-102D1						UCX06-102D1	CX06D1	
$1\frac{3}{8}$	UCCX06-103D1						UCX06-103D1	CX06D1	
$1\frac{1}{4}$	UCCX06-104D1						UC207-104D1	CX06D1	
35	UCCX07D1	110	34	2.5	49.2	19	UCX07D1	CX07D1	1.8
$1\frac{5}{16}$	UCCX07-105D1	4.3307	$1\frac{11}{32}$	0.098	1.9370	0.748	UCX07-105D1	CX07D1	4.0
$1\frac{3}{8}$	UCCX07-106D1						UCX07-106D1	CX07D1	
$1\frac{7}{16}$	UCCX07-107D1						UCX07-107D1	CX07D1	
40	UCCX08D1	120	38	2.5	49.2	19	UCX08D1	CX08D1	2.5
$1\frac{1}{2}$	UCCX08-108D1	4.7244	$1\frac{1}{2}$	0.098	1.9370	0.748	UCX08-108D1	CX08D1	5.5
$1\frac{9}{16}$	UCCX08-109D1						UCX08-109D1	CX08D1	
45	UCCX09D1	120	38	2.5	51.6	19	UCX09D1	CX09D1	2.2
$1\frac{5}{8}$	UCCX09-110D1	4.7244	$1\frac{1}{2}$	0.098	2.0315	0.748	UCX09-110D1	CX09D1	4.9
$1\frac{11}{16}$	UCCX09-111D1						UCX09-111D1	CX09D1	
$1\frac{3}{4}$	UCCX09-112D1						UCX09-112D1	CX09D1	
$1\frac{13}{16}$	UCCX09-113D1						UC210-113D1	CX09D1	
50	UCCX10D1	130	40	2.5	55.6	22.2	UCX10D1	CX10D1	2.7
$1\frac{7}{8}$	UCCX10-114D1	5.1181	$1\frac{37}{64}$	0.098	2.1890	0.874	UCX10-114D1	CX10D1	6.0
$1\frac{15}{16}$	UCCX10-115D1						UCX10-115D1	CX10D1	
2	UCCX10-200D1						UC211-200D1	CX10D1	

Note (1) These numbers indicate relubricatable type. If maintenance free type is needed, please order without suffix "D1".

Remarks Please refer to page A21 for size of grease fitting.

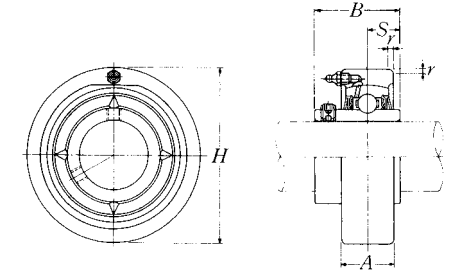

Shaft dia. mm inch	Unit number (1)	Nominal dimensions					Bearing number	Housing number	Mass of unit kg lb
		H	A	r	B	S			
55	UCCX11D1	150	42	3	65.1	25.4	UCX11D1	CX11D1	4.1
$2\frac{1}{16}$	UCCX11-201D1	5.9055	$1\frac{21}{32}$	0.118	2.5630	1.000	UCX11-201D1	CX11D1	9.0
$2\frac{1}{8}$	UCCX11-202D1						UCX11-202D1	CX11D1	
$2\frac{3}{16}$	UCCX11-203D1						UCX11-203D1	CX11D1	
$2\frac{1}{4}$	UCCX11-204D1						UC212-204D1	CX11D1	
$2\frac{5}{16}$	UCCX11-205D1						UC212-205D1	CX11D1	
60	UCCX12D1	160	44	3	65.1	25.4	UCX12D1	CX12D1	3.9
$2\frac{3}{8}$	UCCX12-206D1	6.2992	$1\frac{47}{64}$	0.118	2.5630	1.000	UCX12-206D1	CX12D1	8.6
$2\frac{7}{16}$	UCCX12-207D1						UCX12-207D1	CX12D1	

Note (1) These numbers indicate relubricatable type. If maintenance free type is needed, please order without suffix "D1".

Remarks Please refer to page A21 for size of grease fitting.

Pillow block unit, cast housing Eccentric locking collar type

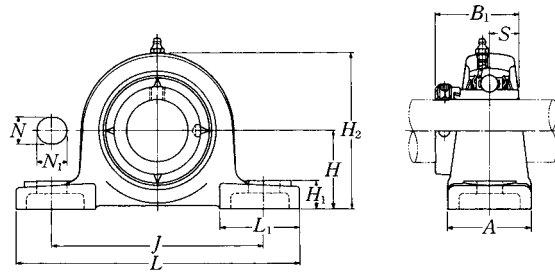

Shaft dia. mm inch	Unit number (1)	Nominal dimensions											Bolt size mm inch	
		mm inch												
		H	L	J	A	N	N ₁	H ₁	H ₂	L ₁	B ₁	S		
20 3/4	UEL204D1W3	33.3	127	95	38	13	16	14	65	42	43.7	17.1	M10	
	UEL204-012D1W3	1 5/16	5	3 3/4	1 1/2	1/2	5/8	9/16	2 9/16	1 21/32	1.720	0.673	3/8	
25 13/16 7/8 15/16	UEL205D1W3	36.5	140	105	38	13	16	15	71	42	44.4	17.45	M10	
	UEL205-013D1W3	1 7/16	5 1/2	4 1/8	1 1/2	1/2	5/8	19/32	2 25/32	1 21/32	1.748	0.687	3/8	
	UEL205-014D1W3													
	UEL205-015D1W3													
1	UEL205-100D1W3													
30 1 1/16 1 1/8 1 3/16 1 1/4	UEL206D1W3	42.9	165	121	48	17	20	17	83	54	48.4	18.25	M14	
	UEL206-101D1W3	1 11/16	6 1/2	4 3/4	1 7/8	21/32	25/32	21/32	3 9/32	2 1/8	1.906	0.719	1/2	
	UEL206-102D1W3													
	UEL206-103D1W3													
1 1/4	UEL206-104D1W3													
35 1 1/4 1 5/16 1 3/8 1 7/16	UEL207D1W3	47.6	167	127	48	17	20	18	93	54	51.1	18.8	M14	
	UEL207-104D1W3	1 7/8	6 9/16	5	1 7/8	21/32	25/32	23/32	3 21/32	2 1/8	2.012	0.740	1/2	
	UEL207-105D1W3													
	UEL207-106D1W3													
1 7/16	UEL207-107D1W3													
40 1 1/2 1 9/16	UEL208D1W3	49.2	184	137	54	17	20	18	98	52	56.3	21.4	M14	
	UEL208-108D1W3	1 15/16	7 1/4	5 13/32	2 1/8	21/32	25/32	23/32	3 27/32	2 1/16	2.217	0.843	1/2	
	UEL208-109D1W3													
45 1 5/8 1 11/16 1 3/4	UEL209D1W3	54	190	146	54	17	20	20	106	60	56.3	21.4	M14	
	UEL209-110D1W3	2 1/8	7 15/32	5 3/4	2 1/8	21/32	25/32	25/32	4 3/16	2 3/8	2.217	0.843	1/2	
	UEL209-111D1W3													
	UEL209-112D1W3													
1 3/4	UEL209-112D1W3													
50 1 13/16 1 7/8 1 15/16 2	UEL210D1W3	57.2	206	159	60	20	23	21	114	65	62.7	24.6	M16	
	UEL210-113D1W3	2 1/4	8 1/8	6 1/4	2 3/8	25/32	29/32	13/16	4 1/2	2 9/16	2.469	0.969	5/8	
	UEL210-114D1W3													
	UEL210-115D1W3													
	UEL210-200D1W3													

Note (1) These numbers indicate relubricatable type. If maintenance free type is needed, please order without suffix "D1".

Remarks Please refer to page A21 for size of grease fitting.

Bearing number	Housing number	Mass of unit kg lb
UEL204D1W3	P204D1	0.8
UEL204-012D1W3	P204D1	1.8
UEL205D1W3	P205D1	0.9
UEL205-013D1W3	P205D1	2.0
UEL205-014D1W3	P205D1	
UEL205-015D1W3	P205D1	
UEL205-100D1W3	P205D1	
UEL206D1W3	P206D1	1.5
UEL206-101D1W3	P206D1	3.3
UEL206-102D1W3	P206D1	
UEL206-103D1W3	P206D1	
UEL206-104D1W3	P206D1	
UEL207D1W3	P207D1	1.8
UEL207-104D1W3	P207D1	4.0
UEL207-105D1W3	P207D1	
UEL207-106D1W3	P207D1	
UEL207-107D1W3	P207D1	
UEL208D1W3	P208D1	2.1
UEL208-108D1W3	P208D1	4.6
UEL208-109D1W3	P208D1	
UEL209D1W3	P209D1	2.3
UEL209-110D1W3	P209D1	5.1
UEL209-111D1W3	P209D1	
UEL209-112D1W3	P209D1	
UEL210D1W3	P210D1	2.9
UEL210-113D1W3	P210D1	6.4
UEL210-114D1W3	P210D1	
UEL210-115D1W3	P210D1	
UEL210-200D1W3	P210D1	

Pillow block unit, cast housing Eccentric locking collar type

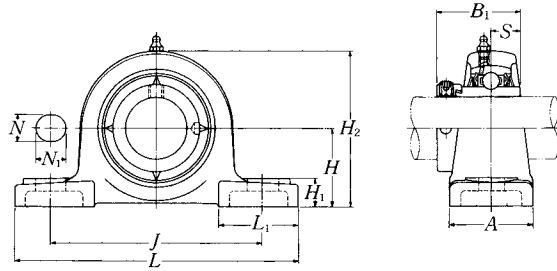

Shaft dia. mm inch	Unit number (1)	Nominal dimensions											Bolt size mm inch
		mm inch											
		H	L	J	A	N	N ₁	H ₁	H ₂	L ₁	B ₁	S	
55	UELP211D1W3	63.5	219	171	60	20	23	23	126	65	71.4	27.75	M16
2	UELP211-200D1W3	2½	8 5/8	6 23/32	2 3/8	25 1/32	29 1/32	29 1/32	4 31/32	2 9/16	2.811	1.093	5/8
2 1/16	UELP211-201D1W3												
2 1/8	UELP211-202D1W3												
2 3/16	UELP211-203D1W3												
60	UELP212D1W3	69.8	241	184	70	20	23	25	138	70	77.8	30.95	M16
2 1/4	UELP212-204D1W3	2 3/4	9 1/2	7 1/4	2 3/4	25 1/32	29 1/32	31 1/32	5 7/16	2 3/4	3.063	1.219	5/8
2 5/16	UELP212-205D1W3												
2 3/8	UELP212-206D1W3												
2 7/16	UELP212-207D1W3												
65	UELP213D1W3	76.2	265	203	70	25	28	27	151	77	85.7	34.15	M20
2 1/2	UELP213-208D1W3	3	10 7/16	8	2 3/4	31 1/32	1 3/32	1 1/16	5 15/16	3 1/32	3.374	1.344	3/4
2 9/16	UELP213-209D1W3												
70	UELP214D1W3	79.4	266	210	72	25	28	27	157	77	85.7	34.15	M20
2 5/8	UELP214-210D1W3	3 1/8	10 15/32	8 9/32	2 27/32	31 1/32	1 3/32	1 1/16	6 3/16	3 1/32	3.374	1.344	3/4
2 11/16	UELP214-211D1W3												
2 3/4	UELP214-212D1W3												
75	UELP215D1W3	82.6	275	217	74	25	28	28	163	80	92	37.3	M20
2 13/16	UELP215-213D1W3	3 1/4	10 13/16	8 17/32	2 29/32	31 1/32	1 3/32	1 3/32	6 13/32	3 5/32	3.622	1.469	3/4
2 7/8	UELP215-214D1W3												
2 15/16	UELP215-215D1W3												
3	UELP215-300D1W3												

Note (1) These numbers indicate relubricatable type. If maintenance free type is needed, please order without suffix "D1".
Remarks Please refer to page A21 for size of grease fitting.

Bearing number	Housing number	Mass of unit kg lb
UEL211D1W3	P211D1	3.7
UEL211-200D1W3	P211D1	8.2
UEL211-201D1W3	P211D1	
UEL211-202D1W3	P211D1	
UEL211-203D1W3	P211D1	
UEL212D1W3	P212D1	5.0
UEL212-204D1W3	P212D1	11
UEL212-205D1W3	P212D1	
UEL212-206D1W3	P212D1	
UEL212-207D1W3	P212D1	
UEL213D1W3	P213D1	6.2
UEL213-208D1W3	P213D1	14
UEL213-209D1W3	P213D1	
UEL214D1W3	P214D1	6.9
UEL214-210D1W3	P214D1	15
UEL214-211D1W3	P214D1	
UEL214-212D1W3	P214D1	
UEL215D1W3	P215D1	7.6
UEL215-213D1W3	P215D1	17
UEL215-214D1W3	P215D1	
UEL215-215D1W3	P215D1	
UEL215-300D1W3	P215D1	

Pillow block unit, cast housing Eccentric locking collar type

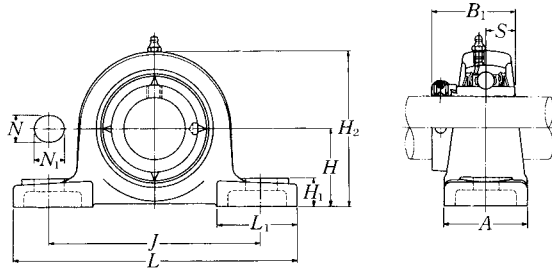

Shaft dia. mm inch	Unit number ⁽¹⁾	Nominal dimensions											Bolt size mm inch
		mm inch											
		H	L	J	A	N	N ₁	H ₁	H ₂	L ₁	B ₁	S	
25 1 3/16 7/8 15/16 1	UELP305D1W3 UELP305-013D1W3 UELP305-014D1W3 UELP305-015D1W3 UELP305-100D1W3	45 1 49/64	175 6 7/8	132 5 3/16	45 1 25/32	17 21/32	20 25/32	15 19/32	85 3 11/32	54 2 1/8	46.8 1.843	16.7 0.657	M14 1/2
30 1 1/16 1 1/8 1 3/16	UELP306D1W3 UELP306-101D1W3 UELP306-102D1W3 UELP306-103D1W3	50 1 31/32	180 7 3/32	140 5 1/2	50 1 31/32	17 21/32	20 25/32	18 23/32	95 3 3/4	54 2 1/8	50 1.969	17.5 0.689	M14 1/2
35 1 1/4 1 5/16 1 3/8 1 7/16	UELP307D1W3 UELP307-104D1W3 UELP307-105D1W3 UELP307-106D1W3 UELP307-107D1W3	56 2 13/64	210 8 9/32	160 6 5/16	56 2 7/32	17 21/32	25 31/32	20 25/32	106 4 3/16	60 2 3/8	51.6 2.031	18.3 0.720	M14 1/2
40 1 1/2 1 9/16	UELP308D1W3 UELP308-108D1W3 UELP308-109D1W3	60 2 23/64	220 8 21/32	170 6 11/16	60 2 3/8	17 21/32	27 1 1/16	22 7/8	116 4 9/16	60 2 3/8	57.1 2.248	19.8 0.780	M14 1/2
45 1 5/8 1 11/16 1 3/4	UELP309D1W3 UELP309-110D1W3 UELP309-111D1W3 UELP309-112D1W3	67 2 41/64	245 9 21/32	190 7 15/32	67 2 5/8	20 25/32	30 1 3/16	24 15/16	129 5 3/32	65 2 9/16	58.7 2.311	19.8 0.780	M16 5/8
50 1 3/16 1 7/8 1 5/16	UELP310D1W3 UELP310-113D1W3 UELP310-114D1W3 UELP310-115D1W3	75 2 61/64	275 10 13/16	212 8 1/32	75 2 15/16	20 25/32	35 1 3/8	27 1 1/16	143 5 5/8	75 2 15/16	66.6 2.622	24.6 0.969	M16 5/8

Note ⁽¹⁾ These numbers indicate relubricatable type. If maintenance free type is needed, please order without suffix "D1".

Remarks Please refer to page A21 for size of grease fitting.

Bearing number	Housing number	Mass of unit kg lb
UEL305D1W3	P305D1	1.5
UEL305-013D1W3	P305D1	3.3
UEL305-014D1W3	P305D1	
UEL305-015D1W3	P305D1	
UEL305-100D1W3	P305D1	
UEL306D1W3	P306D1	1.9
UEL306-101D1W3	P306D1	4.2
UEL306-102D1W3	P306D1	
UEL306-103D1W3	P306D1	
UEL307D1W3	P307D1	2.6
UEL307-104D1W3	P307D1	5.7
UEL307-105D1W3	P307D1	
UEL307-106D1W3	P307D1	
UEL307-107D1W3	P307D1	
UEL308D1W3	P308D1	3.2
UEL308-108D1W3	P308D1	7.1
UEL308-109D1W3	P308D1	
UEL309D1W3	P309D1	4.2
UEL309-110D1W3	P309D1	9.3
UEL309-111D1W3	P309D1	
UEL309-112D1W3	P309D1	
UEL310D1W3	P310D1	5.8
UEL310-113D1W3	P310D1	13
UEL310-114D1W3	P310D1	
UEL310-115D1W3	P310D1	

Pillow block unit, cast housing Eccentric locking collar type

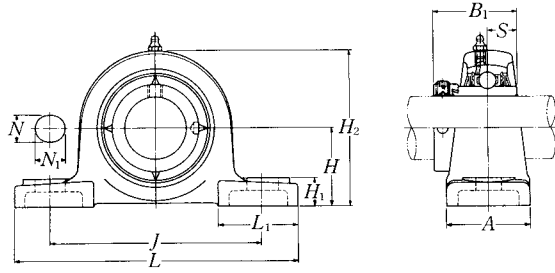

Shaft dia. mm inch	Unit number (1)	Nominal dimensions											Bolt size mm inch
		mm inch											
		H	L	J	A	N	N ₁	H ₁	H ₂	L ₁	B ₁	S	
55 2 2 1/16 2 1/8 2 3/16	UELP311D1W3 UELP311-200D1W3 UELP311-201D1W3 UELP311-202D1W3 UELP311-203D1W3	80	310	236	80	20	38	30	154	85	73	27.8	M16
		3 5/32	12 7/32	9 9/32	3 5/32	25/32	1 1/2	1 3/16	6 1/16	3 11/32	2.874	1.094	5/8
60 2 1/4 2 5/16 2 3/8 2 7/16	UELP312D1W3 UELP312-204D1W3 UELP312-205D1W3 UELP312-206D1W3 UELP312-207D1W3	85	330	250	85	25	38	32	165	95	79.4	30.95	M20
		3 11/32	13	9 27/32	3 11/32	31/32	1 1/2	1 1/4	6 1/2	3 3/4	3.126	1.219	3/4
65 2 1/2 2 9/16	UELP313D1W3 UELP313-208D1W3 UELP313-209D1W3	90	340	260	90	25	38	33	176	105	85.7	32.55	M20
		3 35/64	13 3/8	10 1/4	3 17/32	31/32	1 1/2	1 5/16	6 15/16	4 1/8	3.374	1.281	3/4
70 2 5/8 2 11/16 2 3/4	UELP314D1W3 UELP314-210D1W3 UELP314-211D1W3 UELP314-212D1W3	95	360	280	90	27	40	35	187	105	92.1	34.15	M22
		3 47/64	14 3/16	11 1/2	3 17/32	1 1/16	1 9/16	1 3/8	7 3/8	4 1/8	3.626	1.344	7/8
75 2 3/16 2 7/8 2 15/16 3	UELP315D1W3 UELP315-213D1W3 UELP315-214D1W3 UELP315-215D1W3 UELP315-300D1W3	100	380	290	100	27	40	35	198	110	100	37.3	M22
		3 15/16	14 31/32	11 13/32	3 15/16	1 1/16	1 9/16	1 3/8	7 25/32	4 11/32	3.937	1.469	7/8
80 3 1/16 3 1/8 3 3/16	UELP316D1W3 UELP316-301D1W3 UELP316-302D1W3 UELP316-303D1W3	106	400	300	110	27	40	40	210	110	106.4	40.5	M22
		4 11/64	15 3/4	11 13/16	4 11/32	1 1/16	1 9/16	1 9/16	8 9/32	4 11/32	4.189	1.594	7/8

Note (1) These numbers indicate relubricatable type. If maintenance free type is needed, please order without suffix "D1".
Remarks Please refer to page A21 for size of grease fitting.

Bearing number	Housing number	Mass of unit kg lb
UEL311D1W3	P311D1	7.6
UEL311-200D1W3	P311D1	17
UEL311-201D1W3	P311D1	
UEL311-202D1W3	P311D1	
UEL311-203D1W3	P311D1	
UEL312D1W3	P312D1	9.7
UEL312-204D1W3	P312D1	21
UEL312-205D1W3	P312D1	
UEL312-206D1W3	P312D1	
UEL312-207D1W3	P312D1	
UEL313D1W3	P313D1	11
UEL313-208D1W3	P313D1	24
UEL313-209D1W3	P313D1	
UEL314D1W3	P314D1	12
UEL314-210D1W3	P314D1	26
UEL314-211D1W3	P314D1	
UEL314-212D1W3	P314D1	
UEL315D1W3	P315D1	15
UEL315-213D1W3	P315D1	33
UEL315-214D1W3	P315D1	
UEL315-215D1W3	P315D1	
UEL315-300D1W3	P315D1	
UEL316D1W3	P316D1	18
UEL316-301D1W3	P316D1	40
UEL316-302D1W3	P316D1	
UEL316-303D1W3	P316D1	

Pillow block unit, cast housing Eccentric locking collar type

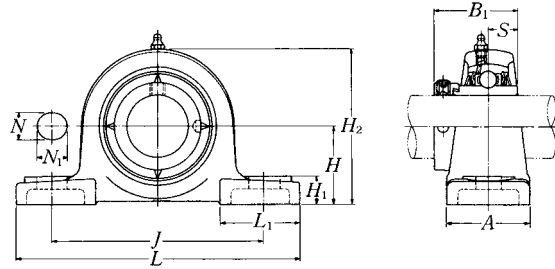

Shaft dia. mm inch	Unit number ⁽¹⁾	Nominal dimensions											Bolt size mm inch
		mm inch											
		H	L	J	A	N	N ₁	H ₁	H ₂	L ₁	B ₁	S	
85 3 1/4 3 5/16 3 7/16	UEL317D1W3 UEL317-304D1W3 UEL317-305D1W3 UEL317-307D1W3	112	420	320	110	33	45	40	220	120	109.5	42.05	M27
		4 13/32	16 17/32	12 19/32	4 11/32	1 5/16	1 25/32	1 9/16	8 21/32	4 23/32	4.311	1.656	1
90 3 7/16 3 1/2	UEL318D1W3 UEL318-307D1W3 UEL318-308D1W3	118	430	330	110	33	45	45	235	120	115.9	43.65	M27
		4 41/64	16 15/16	13	4 11/32	1 5/16	1 25/32	1 25/32	9 1/4	4 23/32	4.563	1.719	1
95 3 5/8 3 11/16 3 3/4	UEL319D1W3 UEL319-310D1W3 UEL319-311D1W3 UEL319-312D1W3	125	470	360	120	36	50	45	250	125	122.3	38.9	M30
		4 59/64	18 1/2	14 3/16	4 23/32	1 13/32	1 31/32	1 25/32	9 27/32	4 29/32	4.815	1.531	1 1/8
100 3 13/16 3 7/8 3 15/16 4	UEL320D1W3 UEL320-313D1W3 UEL320-314D1W3 UEL320-315D1W3 UEL320-400D1W3	140	490	380	120	36	50	50	275	130	128.6	50	M30
		5 33/64	19 9/32	14 31/32	4 23/32	1 13/32	1 31/32	1 31/32	10 13/16	5 1/8	5.063	1.969	1 1/8
105	UEL321D1W3	140	490	380	120	36	50	50	280	130	139.7	48.4	M30
110	UEL322D1W3	150	520	400	140	40	55	55	300	135	141.3	49.2	M33

Note ⁽¹⁾ These numbers indicate relubricatable type. If maintenance free type is needed, please order without suffix "D1".
Remarks Please refer to page A21 for size of grease fitting.

Bearing number	Housing number	Mass of unit kg lb
UEL317D1W3	P317D1	21
UEL317-304D1W3	P317D1	46
UEL317-305D1W3	P317D1	
UEL317-307D1W3	P317D1	
UEL318D1W3	P318D1	23
UEL318-307D1W3	P318D1	51
UEL318-308D1W3	P318D1	
UEL319D1W3	P319D1	28
UEL319-310D1W3	P319D1	62
UEL319-311D1W3	P319D1	
UEL319-312D1W3	P319D1	
UEL320D1W3	P320D1	35
UEL320-313D1W3	P320D1	77
UEL320-314D1W3	P320D1	
UEL320-315D1W3	P320D1	
UEL320-400D1W3	P320D1	
UEL321D1W3	P321D1	37
UEL322D1W3	P322D1	46

Pillow block unit, cast housing low center height Eccentric locking collar type

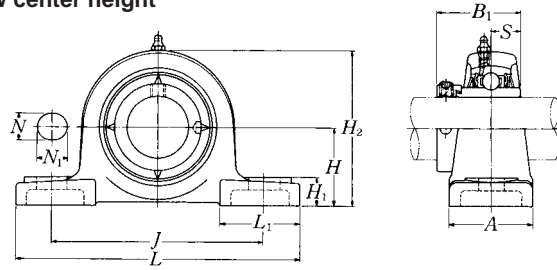

Shaft dia. mm inch	Unit number ⁽¹⁾ (²)(³)	Nominal dimensions											Bolt size mm inch
		H	L	J	A	N	N ₁	H ₁	H ₂	L ₁	B ₁	S	
20 3/4	UELPL204D1W3	31.75	127	95	38	13	16	14	64	42	43.7	17.1	M10
	UELPL204-012D1W3	1 1/4	5	3 3/4	1 1/2	1/2	5/8	9/16	2 17/32	1 21/32	1.720	0.673	3/8
25 1 3/16 7/8 15/16	UELPL205D1W3	33.34	140	105	38	13	16	15	68	42	44.4	17.45	M10
	UELPL205-013D1W3												
	UELPL205-014D1W3												
	UELPL205-015D1W3	1 5/16	5 1/2	4 1/8	1 1/2	1/2	5/8	19/32	2 11/16	1 21/32	1.748	0.687	3/8
1	UELPL205-100D1W3												
30 1 1/16 1 1/8 1 3/16 1 1/4	UELPL206D1W3	39.69	165	121	48	17	20	17	80	54	48.4	18.25	M14
	UELPL206-101D1W3												
	UELPL206-102D1W3	1 9/16	6 1/2	4 3/4	1 7/8	21/32	25/32	21/32	3 5/32	2 1/8	1.906	0.719	1/2
	UELPL206-103D1W3												
1 1/4	UELPL206-104D1W3												
35 1 1/4 1 5/16 1 3/8 1 7/16	UELPL207D1W3	46.04	167	127	48	17	20	18	91	54	51.1	18.8	M14
	UELPL207-104D1W3												
	UELPL207-105D1W3	1 13/16	6 9/16	5	1 7/8	21/32	25/32	23/32	3 19/32	2 1/8	2.012	0.740	1/2
	UELPL207-106D1W3												
1 7/16	UELPL207-107D1W3												
45 1 5/8 1 11/16 1 3/4	UELPL209D1W3	52.39	190	146	54	17	20	20	104	60	56.3	21.4	M14
	UELPL209-110D1W3												
	UELPL209-111D1W3	2 1/16	7 15/32	5 3/4	2 1/8	21/32	25/32	25/32	4 3/32	2 3/8	2.217	0.843	1/2
	UELPL209-112D1W3												
50 1 13/16 1 7/8 1 15/16	UELPL210D1W3	55.56	206	159	60	20	23	21	112	65	62.7	24.6	M16
	UELPL210-113D1W3												
	UELPL210-114D1W3	2 3/16	8 1/8	6 1/4	2 3/8	25/32	29/32	13/16	4 13/32	2 9/16	2.469	0.969	5/8
	UELPL210-115D1W3												
2	UELPL210-200D1W3												

Notes (1) These numbers indicate relubricatable type. If maintenance free type is needed, please order without suffix "D1".

(2) UELPL204 and UELPL205 has solid bases.

(3) UELPL208 has the same dimension as UELP208 shown in page B148.

Remarks Please refer to page A21 for size of grease fitting.

Bearing number	Housing number	Mass of unit kg lb
UEL204D1W3	PL204D1	0.8
UEL204-012D1W3	PL204D1	1.8
UEL205D1W3	PL205D1	0.9
UEL205-013D1W3	PL205D1	
UEL205-014D1W3	PL205D1	2.0
UEL205-015D1W3	PL205D1	
UEL205-100D1W3	PL205D1	
UEL206D1W3	PL206D1	1.4
UEL206-101D1W3	PL206D1	
UEL206-102D1W3	PL206D1	3.1
UEL206-103D1W3	PL206D1	
UEL206-104D1W3	PL206D1	
UEL207D1W3	PL207D1	1.7
UEL207-104D1W3	PL207D1	
UEL207-105D1W3	PL207D1	3.7
UEL207-106D1W3	PL207D1	
UEL207-107D1W3	PL207D1	
UEL209D1W3	PL209D1	2.3
UEL209-110D1W3	PL209D1	
UEL209-111D1W3	PL209D1	5.1
UEL209-112D1W3	PL209D1	
UEL210D1W3	PL210D1	3.0
UEL210-113D1W3	PL210D1	
UEL210-114D1W3	PL210D1	6.6
UEL210-115D1W3	PL210D1	
UEL210-200D1W3	PL210D1	

UELPL2

Pillow block unit, cast housing low center height Eccentric locking collar type

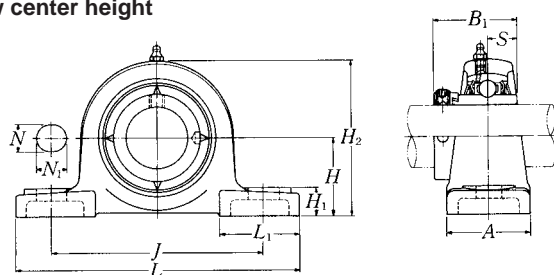

Shaft dia. mm inch	Unit number ⁽¹⁾	Nominal dimensions											Bolt size mm inch
		mm inch											
		H	L	J	A	N	N ₁	H ₁	H ₂	L ₁	B ₁	S	
55	UELPL211D1W3	61.91	219	171	60	20	23	23	124	65	71.4	27.75	M16
2	UELPL211-200D1W3												
2 1/16	UELPL211-201D1W3												
2 1/8	UELPL211-202D1W3	2 7/16	8 5/8	6 23/32	2 3/8	25/32	29/32	29/32	4 7/8	2 9/16	2.811	1.093	5/8
2 3/16	UELPL211-203D1W3												
60	UELPL212D1W3	68.26	241	184	70	20	23	25	136	70	77.8	30.95	M16
2 1/4	UELPL212-204D1W3												
2 5/16	UELPL212-205D1W3												
2 3/8	UELPL212-206D1W3	2 11/16	9 1/2	7 1/4	2 3/4	25/32	29/32	31/32	5 11/32	2 3/4	3.063	1.219	5/8
2 7/16	UELPL212-207D1W3												

Note ⁽¹⁾ These numbers indicate relubricatable type. If maintenance free type is needed, please order without suffix "D1".

Remarks Please refer to page A21 for size of grease fitting.

Bearing number	Housing number	Mass of unit kg lb
UEL211D1W3	PL211D1	3.7
UEL211-200D1W3	PL211D1	
UEL211-201D1W3	PL211D1	8.2
UEL211-202D1W3	PL211D1	
UEL211-203D1W3	PL211D1	
UEL212D1W3	PL212D1	5.0
UEL212-204D1W3	PL212D1	
UEL212-205D1W3	PL212D1	11
UEL212-206D1W3	PL212D1	
UEL212-207D1W3	PL212D1	

Pillow block unit, cast housing high center height Eccentric locking collar type

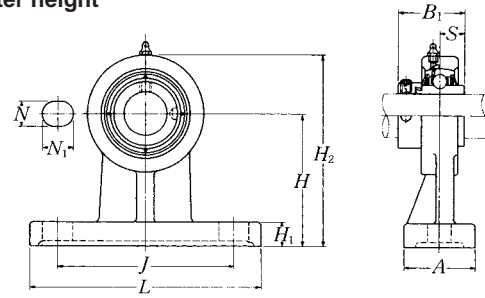

Shaft dia. mm inch	Unit number (1)	Nominal dimensions										Bolt size mm inch
		mm inch										
		H	L	J	A	N	N ₁	H ₁	H ₂	B ₁	S	
20 3/4	UELHP204D1W3	70	127	95	40	13	19	13	101	43.7	17.1	M10
	UELHP204-012D1W3	2 3/4	5	3 3/4	1 9/16	1/2	3/4	1/2	3 31/32	1.720	0.673	3/8
25 13/16 7/8 15/16	UELHP205D1W3	80	142	105	50	13	19	13	114	44.4	17.45	M10
	UELHP205-013D1W3											
	UELHP205-014D1W3											
	UELHP205-015D1W3	3 5/32	5 19/32	4 1/8	1 31/32	1/2	3/4	1/2	4 1/2	1.748	0.687	3/8
1	UELHP205-100D1W3											
30 1 1/16 1 1/8 1 3/16 1 1/4	UELHP206D1W3	90	165	120	50	17	21	16	130	48.4	18.25	M14
	UELHP206-101D1W3											
	UELHP206-102D1W3											
	UELHP206-103D1W3	3 35/64	6 1/2	4 23/32	1 31/32	2 1/32	1 3/16	5/8	5 1/8	1.906	0.719	1/2
1 1/4	UELHP206-104D1W3											
35 1 1/4 1 5/16 1 3/8 1 7/16	UELHP207D1W3	95	166	127	60	17	21	18	140	51.1	18.8	M14
	UELHP207-104D1W3											
	UELHP207-105D1W3											
	UELHP207-106D1W3	3 47/64	6 17/32	5	2 3/8	2 1/32	1 3/16	23/32	5 1/2	2.012	0.740	1/2
1 7/16	UELHP207-107D1W3											
40 1 1/2 1 9/16	UELHP208D1W3	100	184	136	70	17	21	20	150	56.3	21.4	M14
	UELHP208-108D1W3											
	UELHP208-109D1W3	3 15/16	7 1/4	5 11/32	2 3/4	2 1/32	1 3/16	25/32	5 29/32	2.217	0.843	1/2
45 1 5/8 1 11/16 1 3/4	UELHP209D1W3	105	190	146	70	17	22	20	158	56.3	21.4	M14
	UELHP209-110D1W3											
	UELHP209-111D1W3											
	UELHP209-112D1W3	4 9/64	7 15/32	5 3/4	2 3/4	2 1/32	7/8	25/32	6 7/32	2.217	0.843	1/2
50 1 13/16 1 7/8 1 15/16 2	UELHP210D1W3	110	206	159	70	20	22	22	165	62.7	24.6	M16
	UELHP210-113D1W3											
	UELHP210-114D1W3											
	UELHP210-115D1W3	4 21/64	8 1/8	6 1/4	2 3/4	2 5/32	7/8	7/8	6 1/2	2.469	0.969	5/8
2	UELHP210-200D1W3											

Note (1) These numbers indicate relubricatable type. If maintenance free type is needed, please order without suffix "D1".

Remarks Please refer to page A21 for size of grease fitting.

Bearing number	Housing number	Mass of unit kg lb
UEL204D1W3	HP204D1	0.9
UEL204-012D1W3	HP204D1	2.0
UEL205D1W3	HP205D1	1.3
UEL205-013D1W3	HP205D1	
UEL205-014D1W3	HP205D1	2.9
UEL205-015D1W3	HP205D1	
UEL205-100D1W3	HP205D1	
UEL206D1W3	HP206D1	1.9
UEL206-101D1W3	HP206D1	
UEL206-102D1W3	HP206D1	4.2
UEL206-103D1W3	HP206D1	
UEL206-104D1W3	HP206D1	
UEL207D1W3	HP207D1	2.4
UEL207-104D1W3	HP207D1	
UEL207-105D1W3	HP207D1	5.3
UEL207-106D1W3	HP207D1	
UEL207-107D1W3	HP207D1	
UEL208D1W3	HP208D1	3.3
UEL208-108D1W3	HP208D1	7.3
UEL208-109D1W3	HP208D1	
UEL209D1W3	HP209D1	3.7
UEL209-110D1W3	HP209D1	
UEL209-111D1W3	HP209D1	8.2
UEL209-112D1W3	HP209D1	
UEL210D1W3	HP210D1	4.1
UEL210-113D1W3	HP210D1	
UEL210-114D1W3	HP210D1	9.0
UEL210-115D1W3	HP210D1	
UEL210-200D1W3	HP210D1	

Narrow pillow block unit, cast housing Eccentric locking collar type

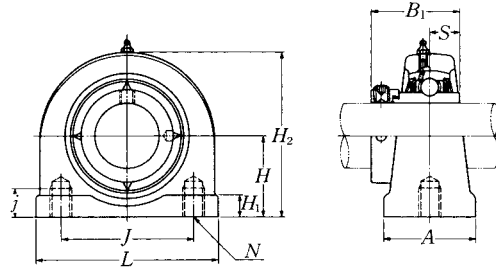

Shaft dia. mm inch	Unit number (1)	Nominal dimensions									
		mm inch									
		H	L	J	A	j	H ₁	H ₂	B ₁	S	N
20 3/4	UELUP204D1W3	30.2	76	52	38	13	11	62	43.7	17.1	M10×1.5
	UELUP204-012D1W3	1 ³ / ₁₆	3	2 ¹ / ₁₆	1 ¹ / ₂	1/2	7/16	2 ⁷ / ₁₆	1.720	0.673	M10×1.5
25 13/16 7/8 15/16	UELUP205D1W3	36.5	84	56	38	15	12	72	44.4	17.45	M10×1.5
	UELUP205-013D1W3										
	UELUP205-014D1W3										
	UELUP205-015D1W3	1 ⁷ / ₁₆	3 ⁵ / ₁₆	2 ⁷ / ₃₂	1 ¹ / ₂	19/32	15/32	2 ²⁷ / ₃₂	1.748	0.687	M10×1.5
1	UELUP205-100D1W3										
30 1 1/16 1 1/8 1 3/16 1 1/4	UELUP206D1W3	42.9	94	66	48	18	12	84	48.4	18.25	M14×2
	UELUP206-101D1W3										
	UELUP206-102D1W3										
	UELUP206-103D1W3	1 ¹¹ / ₁₆	3 ¹¹ / ₁₆	2 ¹⁹ / ₃₂	1 ⁷ / ₈	23/32	15/32	3 ⁵ / ₁₆	1.906	0.719	M14×2
1 1/4	UELUP206-104D1W3										
35 1 1/4 1 5/16 1 3/8 1 7/16	UELUP207D1W3	47.6	110	80	48	20	13	95	51.1	18.8	M14×2
	UELUP207-104D1W3										
	UELUP207-105D1W3										
	UELUP207-106D1W3	1 ⁷ / ₈	4 ¹¹ / ₃₂	3 ⁵ / ₃₂	1 ⁷ / ₈	25/32	1/2	3 ³ / ₄	2.012	0.740	M14×2
1 7/16	UELUP207-107D1W3										
40 1 1/2 1 9/16	UELUP208D1W3	49.2	116	84	54	20	13	100	56.3	21.4	M14×2
	UELUP208-108D1W3										
	UELUP208-109D1W3	1 ¹⁵ / ₁₆	4 ⁹ / ₁₆	3 ⁵ / ₁₆	2 ¹ / ₈	25/32	1/2	3 ¹⁵ / ₁₆	2.217	0.843	M14×2
45 1 5/8 1 11/16 1 3/4	UELUP209D1W3	54.2	120	90	54	25	13	108	56.3	21.4	M14×2
	UELUP209-110D1W3										
	UELUP209-111D1W3										
	UELUP209-112D1W3	2 ⁹ / ₆₄	4 ²³ / ₃₂	3 ¹⁷ / ₃₂	2 ¹ / ₈	31/32	1/2	4 ¹ / ₄	2.217	0.843	M14×2
50 1 13/16 1 7/8 1 15/16 2	UELUP210D1W3	57.2	130	94	60	25	14	116	62.7	24.6	M16×2
	UELUP210-113D1W3										
	UELUP210-114D1W3										
	UELUP210-115D1W3	2 ¹ / ₄	5 ¹ / ₈	3 ¹¹ / ₁₆	2 ³ / ₈	31/32	9/16	4 ⁹ / ₁₆	2.469	0.969	M16×2
	UELUP210-200D1W3										

Note (1) These numbers indicate relubricatable type. If maintenance free type is needed, please order without suffix "D1".

Remarks Please refer to page A21 for size of grease fitting.

Bearing number	Housing number	Mass of unit kg lb
UEL204D1W3	UP204D1	0.6
UEL204-012D1W3	UP204D1	1.3
UEL205D1W3	UP205D1	0.8
UEL205-013D1W3	UP205D1	
UEL205-014D1W3	UP205D1	1.8
UEL205-015D1W3	UP205D1	
UEL205-100D1W3	UP205D1	
UEL206D1W3	UP206D1	1.3
UEL206-101D1W3	UP206D1	
UEL206-102D1W3	UP206D1	2.9
UEL206-103D1W3	UP206D1	
UEL206-104D1W3	UP206D1	
UEL207D1W3	UP207D1	1.7
UEL207-104D1W3	UP207D1	
UEL207-105D1W3	UP207D1	3.7
UEL207-106D1W3	UP207D1	
UEL207-107D1W3	UP207D1	
UEL208D1W3	UP208D1	2.0
UEL208-108D1W3	UP208D1	4.4
UEL208-109D1W3	UP208D1	
UEL209D1W3	UP209D1	2.3
UEL209-110D1W3	UP209D1	
UEL209-111D1W3	UP209D1	5.1
UEL209-112D1W3	UP209D1	
UEL210D1W3	UP210D1	2.8
UEL210-113D1W3	UP210D1	
UEL210-114D1W3	UP210D1	6.2
UEL210-115D1W3	UP210D1	
UEL210-200D1W3	UP210D1	

Pillow block unit, cast housing low center height Eccentric locking collar type

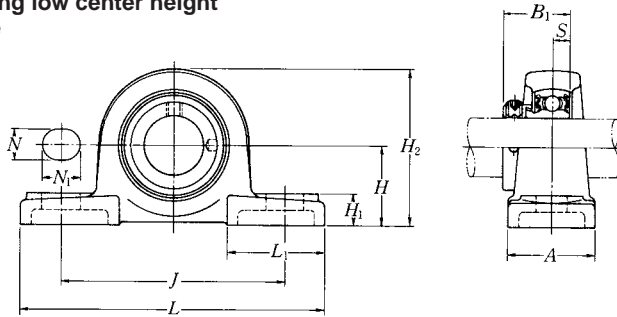

Shaft dia. mm inch	Unit number ⁽¹⁾ (²)	Nominal dimensions											Bolt size mm inch
		H	L	J	A	N	N ₁	H ₁	H ₂	L ₁	B ₁	S	
12 1/2	AELPL201W3	26.99	121	89	35	11	14	13	54	40	28.6	6.5	M10
	AELPL201-008W3	1 1/16	4 3/4	3 1/2	1 3/8	7/16	9/16	1/2	2 1/8	1 9/16	1.126	0.256	3/8
15 9/16 5/8	AELPL202W3	26.99	121	89	35	11	14	13	54	40	28.6	6.5	M10
	AELPL202-009W3	1 1/16	4 3/4	3 1/2	1 3/8	7/16	9/16	1/2	2 1/8	1 9/16	1.126	0.256	3/8
	AELPL202-010W3	1 1/16	4 3/4	3 1/2	1 3/8	7/16	9/16	1/2	2 1/8	1 9/16	1.126	0.256	3/8
17 11/16	AELPL203W3	26.99	121	89	35	11	14	13	54	40	28.6	6.5	M10
	AELPL203-011W3	1 1/16	4 3/4	3 1/2	1 3/8	7/16	9/16	1/2	2 1/8	1 9/16	1.126	0.256	3/8
20 3/4	AELPL204W3	31.75	127	95	38	13	16	14	64	42	31	7.5	M10
	AELPL204-012W3	1 1/4	5	3 3/4	1 1/2	1/2	5/8	9/16	2 17/32	1 21/32	1.220	0.295	3/8
25 13/16 7/8 15/16 1	AELPL205W3	33.34	140	105	38	13	16	15	68	42	31	7.5	M10
	AELPL205-013W3												
	AELPL205-014W3	1 5/16	5 1/2	4 1/8	1 1/2	1/2	5/8	19/32	2 1/16	1 21/32	1.220	0.295	3/8
	AELPL205-015W3												
30 1 1/16 1 1/8 1 3/16 1 1/4	AELPL206W3	39.69	165	121	48	17	20	17	80	54	35.7	9	M14
	AELPL206-101W3												
	AELPL206-102W3	1 9/16	6 1/2	4 3/4	1 7/8	21/32	25/32	21/32	3 5/32	2 1/8	1.406	0.354	1/2
	AELPL206-104W3												
35 1 1/4 1 5/16 1 3/8 1 7/16	AELPL207W3	46.04	167	127	48	17	20	18	91	54	38.9	9.5	M14
	AELPL207-104W3												
	AELPL207-105W3	1 13/16	6 9/16	5	1 7/8	21/32	25/32	23/32	3 19/32	2 1/8	1.531	0.374	1/2
	AELPL207-107W3												

Notes ⁽¹⁾ AELPL201 to AELPL205 has solid base.

⁽²⁾ If relubricatable type is needed, please order with suffix "D1".

Bearing number	Housing number	Mass of unit kg lb
AEL201W3	PL201	0.5
AEL201-008W3	PL201	1.1
AEL202W3	PL201	0.5
AEL202-009W3	PL201	1.1
AEL202-010W3	PL201	1.1
AEL203W3	PL201	0.5
AEL203-011W3	PL201	1.1
AEL204W3	PL204	0.7
AEL204-012W3	PL204	1.5
AEL205W3	PL205	0.8
AEL205-013W3	PL205	
AEL205-014W3	PL205	1.8
AEL205-015W3	PL205	
AEL205-100W3	PL205	
AEL206W3	PL206	1.3
AEL206-101W3	PL206	
AEL206-102W3	PL206	2.9
AEL206-103W3	PL206	
AEL206-104W3	PL206	
AEL207W3	PL207	1.6
AEL207-104W3	PL207	
AEL207-105W3	PL207	3.5
AEL207-106W3	PL207	
AEL207-107W3	PL207	

Pillow block unit, cast housing low center height Eccentric locking collar type

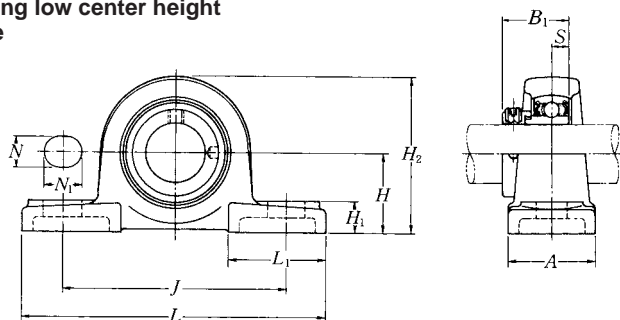

Shaft dia. mm inch	Unit number ⁽¹⁾ (²)	Nominal dimensions												Bolt size mm inch
		mm inch												
		H	L	J	A	N	N ₁	H ₁	H ₂	L ₁	B ₁	S		
12 1/2	JELPL201W3	26.99	121	89	35	11	14	13	54	40	28.6	6.5	M10	
	JELPL201-008W3	1 1/16	4 3/4	3 1/2	1 3/8	7/16	9/16	1/2	2 1/8	1 9/16	1.126	0.256	3/8	
15 9/16 5/8	JELPL202W3	26.99	121	89	35	11	14	13	54	40	28.6	6.5	M10	
	JELPL202-009W3 JELPL202-010W3	1 1/16	4 3/4	3 1/2	1 3/8	7/16	9/16	1/2	2 1/8	1 9/16	1.126	0.256	3/8	
17 11/16	JELPL203W3	26.99	121	89	35	11	14	13	54	40	28.6	6.5	M10	
	JELPL203-011W3	1 1/16	4 3/4	3 1/2	1 3/8	7/16	9/16	1/2	2 1/8	1 9/16	1.126	0.256	3/8	
20 3/4	JELPL204W3	31.75	127	95	38	13	16	14	64	42	31	7.5	M10	
	JELPL204-012W3	1 1/4	5	3 3/4	1 1/2	1/2	5/8	9/16	2 17/32	1 21/32	1.220	0.295	3/8	
25 13/16 7/8 15/16 1	JELPL205W3	33.34	140	105	38	13	16	15	68	42	31	7.5	M10	
	JELPL205-013W3													
	JELPL205-014W3	1 5/16	5 1/2	4 1/8	1 1/2	1/2	5/8	19/32	2 11/16	1 21/32	1.220	0.295	3/8	
	JELPL205-015W3 JELPL205-100W3													
30 1 1/16 1 1/8 1 3/16 1 1/4	JELPL206W3	39.69	165	121	48	17	20	17	80	54	35.7	9	M14	
	JELPL206-101W3													
	JELPL206-102W3	1 9/16	6 1/2	4 3/4	1 7/8	21/32	25/32	21/32	3 5/32	2 1/8	1.406	0.354	1/2	
	JELPL206-103W3 JELPL206-104W3													
35 1 1/4 1 5/16 1 3/8 1 7/16	JELPL207W3	46.04	167	127	48	17	20	18	91	54	38.9	9.5	M14	
	JELPL207-104W3													
	JELPL207-105W3	1 13/16	6 9/16	5	1 7/8	21/32	25/32	23/32	3 19/32	2 1/8	1.531	0.374	1/2	
	JELPL207-106W3 JELPL207-107W3													

Notes ⁽¹⁾ JELPL201 to JELPL205 have solid bases.
⁽²⁾ If relubricatable type is needed, please order with suffix "D1".

Bearing number	Housing number	Mass of unit kg lb
JEL201W3	PL201	0.5
JEL201-008W3	PL201	1.1
JEL202W3	PL201	0.5
JEL202-009W3	PL201	1.1
JEL202-010W3	PL201	1.1
JEL203W3	PL201	0.5
JEL203-011W3	PL201	1.1
JEL204W3	PL204	0.7
JEL204-012W3	PL204	1.5
JEL205W3	PL205	0.8
JEL205-013W3	PL205	1.8
JEL205-014W3	PL205	1.8
JEL205-015W3	PL205	1.8
JEL205-100W3	PL205	1.8
JEL206W3	PL206	1.3
JEL206-101W3	PL206	2.9
JEL206-102W3	PL206	2.9
JEL206-103W3	PL206	2.9
JEL206-104W3	PL206	2.9
JEL207W3	PL207	1.6
JEL207-104W3	PL207	3.5
JEL207-105W3	PL207	3.5
JEL207-106W3	PL207	3.5
JEL207-107W3	PL207	3.5

Pillow block unit, pressed steel housing Eccentric locking collar type

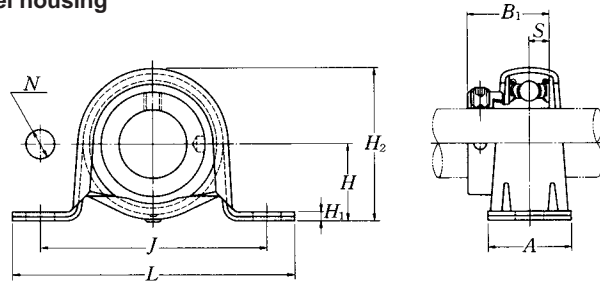

Shaft dia. mm inch	Unit number	Nominal dimensions										Bolt size mm inch
		mm inch										
		H	L	J	A	N	H ₁	H ₂	B ₁	S		
12 1/2	AELPP201W3 AELPP201-008W3	22.2 7/8	86 3 3/8	68 2 11/16	25 31/32	9.5 3/8	3.2 0.126	43.8 1 23/32	28.6 1.126	6.5 0.256	M8 5/16	
15 9/16 5/8	AELPP202W3 AELPP202-009W3 AELPP202-010W3	22.2 7/8	86 3 3/8	68 2 11/16	25 31/32	9.5 3/8	3.2 0.126	43.8 1 23/32	28.6 1.126	6.5 0.256	M8 5/16	
17 11/16	AELPP203W3 AELPP203-011W3	22.2 7/8	86 3 3/8	68 2 11/16	25 31/32	9.5 3/8	3.2 0.126	43.8 1 23/32	28.6 1.126	6.5 0.256	M8 5/16	
20 3/4	AELPP204W3 AELPP204-012W3	25.4 1	98 3 27/32	76 3	32 1 1/4	9.5 3/8	3.2 0.126	50.5 2	31 1.220	7.5 0.295	M8 5/16	
25 13/16 7/8 15/16 1	AELPP205W3 AELPP205-013W3 AELPP205-014W3 AELPP205-015W3 AELPP205-100W3	28.6 1 1/8	108 4 1/4	86 3 3/8	32 1 1/4	11.5 29/64	4 0.157	56.6 2 7/32	31 1.220	7.5 0.295	M10 3/8	
30 1 1/16 1 1/8 1 3/16 1 1/4	AELPP206W3 AELPP206-101W3 AELPP206-102W3 AELPP206-103W3 AELPP206-104W3	33.3 1 5/16	117 4 19/32	95 3 3/4	38 1 1/2	11.5 29/64	4 0.157	66.3 2 5/8	35.7 1.406	9 0.354	M10 3/8	
35 1 1/4 1 5/16 1 3/8 1 7/16	AELPP207W3 AELPP207-104W3 AELPP207-105W3 AELPP207-106W3 AELPP207-107W3	39.7 1 9/16	129 5 3/32	106 4 3/16	42 1 21/32	11.5 29/64	4.6 0.181	78 3 1/16	38.9 1.531	9.5 0.374	M10 3/8	

Note (1) The permissible load only applies in applications where the load is stable and the speed is 2400 min⁻¹ or less.
The mounting surface should be flat.

Max. load (1) recommended N lbf		Bearing number	Housing number	Mass of unit kg lb
radial	axial			
2 000 440	800 160	AEL201W3 AEL201-008W3	PP203 PP203	0.2 0.4
2 000 440	800 160	AEL202W3 AEL202-009W3 AEL202-010W3	PP203 PP203 PP203	0.2 0.4
2 000 440	800 160	AEL203W3 AEL203-011W3	PP203 PP203	0.2 0.4
2 500 550	1 000 200	AEL204W3 AEL204-012W3	PP204 PP204	0.3 0.7
3 500	1 400	AEL205W3 AEL205-013W3 AEL205-014W3 AEL205-015W3 AEL205-100W3	PP205 PP205 PP205 PP205 PP205	0.3 0.7
4 000	1 600	AEL206W3 AEL206-101W3 AEL206-102W3 AEL206-103W3 AEL206-104W3	PP206 PP206 PP206 PP206 PP206	0.5 1.1
4 500	1 800	AEL207W3 AEL207-104W3 AEL207-105W3 AEL207-106W3 AEL207-107W3	PP207 PP207 PP207 PP207 PP207	0.8 1.8

Pillow block unit, pressed steel housing with rubber ring Eccentric locking collar type

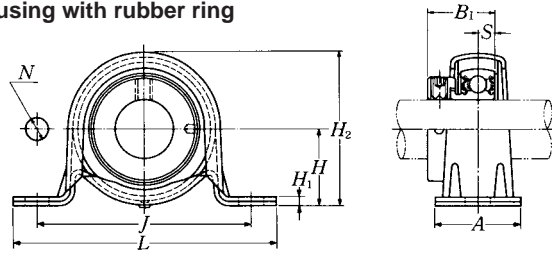

Shaft dia. mm inch	Unit number	Nominal dimensions										Bolt size mm inch
		mm inch										
		H	L	J	A	N	H ₁	H ₂	B ₁	S		
12 1/2	AELRPP201W3	25.4	98	76	32	9.5	3.2	50.5	28.6	6.5	M8	
	AELRPP201-008W3	1	3 ²⁷ / ₃₂	3	1 ¹ / ₄	³ / ₈	0.126	2	1.126	0.256	⁵ / ₁₆	
15 9/16 5/8	AELRPP202W3	25.4	98	76	32	9.5	3.2	50.5	28.6	6.5	M8	
	AELRPP202-009W3	1	3 ²⁷ / ₃₂	3	1 ¹ / ₄	³ / ₈	0.126	2	1.126	0.256	⁵ / ₁₆	
	AELRPP202-010W3											
17 11/16	AELRPP203W3	25.4	98	76	32	9.5	3.2	50.5	28.6	6.5	M8	
	AELRPP203-011W3	1	3 ²⁷ / ₃₂	3	1 ¹ / ₄	³ / ₈	0.126	2	1.126	0.256	⁵ / ₁₆	
20 3/4	AELRPP204W3	28.6	108	86	32	11.5	4	56.6	31	7.5	M10	
	AELRPP204-012W3	1 ¹ / ₈	4 ¹ / ₄	3 ³ / ₈	1 ¹ / ₄	²⁹ / ₆₄	0.157	2 ⁷ / ₃₂	1.220	0.295	³ / ₈	
25 13/16 7/8 15/16 1	AELRPP205W3	33.3	117	95	38	11.5	4	66.3	31	7.5	M10	
	AELRPP205-013W3											
	AELRPP205-014W3	1 ⁵ / ₁₆	4 ¹⁹ / ₃₂	3 ³ / ₄	1 ¹ / ₂	²⁹ / ₆₄	0.157	2 ⁵ / ₈	1.220	0.295	³ / ₈	
	AELRPP205-015W3											
	AELRPP205-100W3											
30 1 1/16 1 1/8 1 3/16 1 1/4	AELRPP206W3	39.7	129	106	42	11.5	4.6	78	35.7	9	M10	
	AELRPP206-101W3											
	AELRPP206-102W3	1 ⁹ / ₁₆	5 ³ / ₃₂	4 ³ / ₁₆	1 ²¹ / ₃₂	²⁹ / ₆₄	0.181	3 ¹ / ₁₆	1.406	0.354	³ / ₈	
	AELRPP206-103W3											
	AELRPP206-104W3											

Note (1) The permissible load only applies in applications where the load is stable and the speed is 2400 min⁻¹ or less.
The mounting surface should be flat.

Remarks When an anti-vibration rubber ring is used, the self alignment capability will be reduce.

Max. load (1) recommended N lbf		Bearing number	Housing number		Mass of unit kg lb
radial	axial		rubber ring	steel	
1 000 220	200 40	AEL201W3	R201	PP204	0.2
		AEL201-008W3	R201	PP204	0.4
1 000 220	200 40	AEL202W3	R202	PP204	0.2
		AEL202-009W3	R202	PP204	0.4
1 000 220	200 40	AEL203W3	R203	PP204	0.2
		AEL203-011W3	R203	PP204	0.4
1 150 250	200 40	AEL204W3	R204	PP205	0.3
		AEL204-012W3	R204	PP205	0.7
1 300 280	200 40	AEL205W3	R205	PP206	0.4
		AEL205-013W3	R205	PP206	0.9
1 500 330	200 40	AEL206W3	R206	PP207	0.6
		AEL206-101W3	R206	PP207	1.3

Square flanged unit, cast housing Eccentric locking collar type

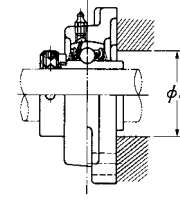
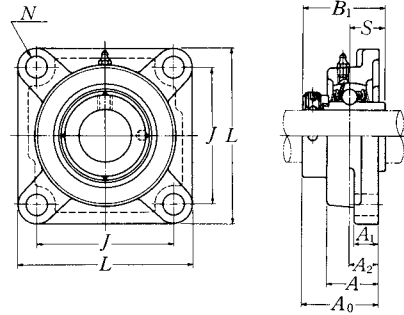

Shaft dia. mm inch	Unit number ⁽¹⁾	Nominal dimensions										Bolt size mm inch
		L	J	A ₂	A ₁	A	N	A ₀	B ₁	S	F min.	
20 3/4	UELF204D1W3	86	64	15	11	25.5	12	41.6	43.7	17.1	34	M10
	UELF204-012D1W3	3 3/8	2 33/64	19/32	7/16	1	15/32	1 41/64	1.720	0.673	1.339	3/8
25 13/16 7/8 15/16 1	UELF205D1W3	95	70	16	13	27	12	42.95	44.4	17.45	38	M10
	UELF205-013D1W3											
	UELF205-014D1W3	3 3/4	2 3/4	5/8	1/2	1 1/16	15/32	1 11/16	1.748	0.687	1.496	3/8
	UELF205-015D1W3											
30 1 1/16 1 1/8 1 3/16 1 1/4	UELF206D1W3	108	83	18	13	31	12	48.15	48.4	18.25	45	M10
	UELF206-101D1W3											
	UELF206-102D1W3	4 1/4	3 17/64	45/64	1/2	1 7/32	15/32	1 57/64	1.906	0.719	1.772	3/8
	UELF206-103D1W3											
35 1 1/4 1 5/16 1 3/8 1 7/16	UELF207D1W3	117	92	19	15	34	14	51.3	51.1	18.8	51	M12
	UELF207-104D1W3											
	UELF207-105D1W3	4 19/32	3 5/8	3/4	19/32	1 11/32	35/64	2 1/64	2.012	0.740	2.008	7/16
	UELF207-106D1W3											
40 1 1/2 1 9/16	UELF208D1W3	130	102	21	15	36	16	55.9	56.3	21.4	57	M14
	UELF208-108D1W3	5 1/8	4 1/64	53/64	19/32	1 13/32	5/8	2 13/64	2.217	0.843	2.244	1/2
	UELF208-109D1W3											
45 1 5/8 1 11/16 1 3/4	UELF209D1W3	137	105	22	16	38	16	56.9	56.3	21.4	62	M14
	UELF209-110D1W3											
	UELF209-111D1W3	5 13/32	4 9/64	55/64	5/8	1 1/2	5/8	2 15/64	2.217	0.843	2.441	1/2
	UELF209-112D1W3											
50 1 13/16 1 7/8 1 15/16 2	UELF210D1W3	143	111	22	16	40	16	60.1	62.7	24.6	67	M14
	UELF210-113D1W3											
	UELF210-114D1W3	5 5/8	4 3/8	55/64	5/8	1 9/16	5/8	2 23/64	2.469	0.969	2.638	1/2
	UELF210-115D1W3											
2	UELF210-200D1W3											

Note ⁽¹⁾ These numbers indicate relubricatable type. If maintenance free type is needed, please order without suffix "D1".

Remarks Please refer to page A21 for size of grease fitting

Bearing number	Housing number	Mass of unit kg lb
UEL204D1W3	F204D1	0.6
UEL204-012D1W3	F204D1	1.3
UEL205D1W3	F205D1	0.9
UEL205-013D1W3	F205D1	
UEL205-014D1W3	F205D1	2.0
UEL205-015D1W3	F205D1	
UEL205-100D1W3	F205D1	
UEL206D1W3	F206D1	1.2
UEL206-101D1W3	F206D1	
UEL206-102D1W3	F206D1	2.6
UEL206-103D1W3	F206D1	
UEL206-104D1W3	F206D1	
UEL207D1W3	F207D1	1.6
UEL207-104D1W3	F207D1	
UEL207-105D1W3	F207D1	3.5
UEL207-106D1W3	F207D1	
UEL207-107D1W3	F207D1	
UEL208D1W3	F208D1	1.9
UEL208-108D1W3	F208D1	4.2
UEL208-109D1W3	F208D1	
UEL209D1W3	F209D1	2.3
UEL209-110D1W3	F209D1	
UEL209-111D1W3	F209D1	5.1
UEL209-112D1W3	F209D1	
UEL210D1W3	F210D1	2.7
UEL210-113D1W3	F210D1	
UEL210-114D1W3	F210D1	6.0
UEL210-115D1W3	F210D1	
UEL210-200D1W3	F210D1	

Square flanged unit, cast housing Eccentric locking collar type

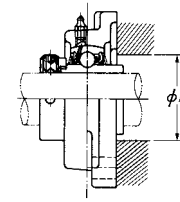
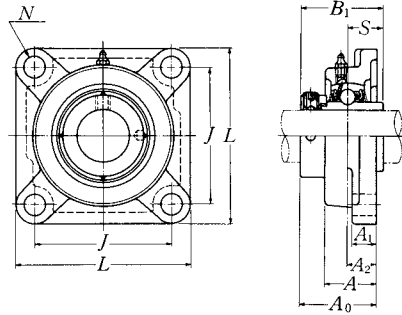

Shaft dia. mm inch	Unit number (1)	Nominal dimensions										Bolt size mm inch
		mm inch										
		L	J	A ₂	A ₁	A	N	A ₀	B ₁	S	F min.	
55 2 2 1/16 2 3/8 2 3/16	UELF211D1W3 UELF211-200D1W3 UELF211-201D1W3 UELF211-202D1W3 UELF211-203D1W3	162	130	25	18	43	19	68.65	71.4	27.75	73	M16 5/8
60 2 1/4 2 5/16 2 3/8 2 7/16	UELF212D1W3 UELF212-204D1W3 UELF212-205D1W3 UELF212-206D1W3 UELF212-207D1W3	175	143	29	18	48	19	75.85	77.8	30.95	81	M16 5/8
65 2 1/2 2 3/16	UELF213D1W3 UELF213-208D1W3 UELF213-209D1W3	187	149	30	22	50	19	81.55	85.7	34.15	87	M16 5/8
70 2 5/8 2 11/16 2 3/4	UELF214D1W3 UELF214-210D1W3 UELF214-211D1W3 UELF214-212D1W3	193	152	31	22	54	19	82.55	85.7	34.15	91	M16 5/8
75 2 9/16 2 7/8 2 15/16 3	UELF215D1W3 UELF215-213D1W3 UELF215-214D1W3 UELF215-215D1W3 UELF215-300D1W3	200	159	34	22	56	19	88.7	92	37.3	97	M16 5/8

Note (1) These numbers indicate relubricatable type. If maintenance free type is needed, please order without suffix "D1".
Remarks Please refer to page A21 for size of grease fitting.

Bearing number	Housing number	Mass of unit kg lb
UEL211D1W3	F211D1	3.6
UEL211-200D1W3	F211D1	7.9
UEL211-201D1W3	F211D1	
UEL211-202D1W3	F211D1	
UEL211-203D1W3	F211D1	
UEL212D1W3	F212D1	4.2
UEL212-204D1W3	F212D1	9.3
UEL212-205D1W3	F212D1	
UEL212-206D1W3	F212D1	
UEL212-207D1W3	F212D1	
UEL213D1W3	F213D1	6.1
UEL213-208D1W3	F213D1	13
UEL213-209D1W3	F213D1	
UEL214D1W3	F214D1	6.6
UEL214-210D1W3	F214D1	15
UEL214-211D1W3	F214D1	
UEL214-212D1W3	F214D1	
UEL215D1W3	F215D1	6.9
UEL215-213D1W3	F215D1	15
UEL215-214D1W3	F215D1	
UEL215-215D1W3	F215D1	
UEL215-300D1W3	F215D1	

Square flanged unit, cast housing Eccentric locking collar type

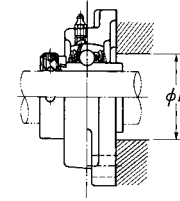
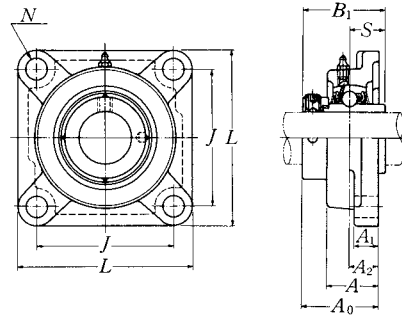

Shaft dia. mm inch	Unit number ⁽¹⁾ (²)	Nominal dimensions										Bolt size mm inch
		mm inch										
		L	J	A ₂	A ₁	A	N	A ₀	B ₁	S	F min.	
25 1 3/16 7/8 15/16 1	UELF305D1W3 UELF305-013D1W3 UELF305-014D1W3 UELF305-015D1W3 UELF305-100D1W3	110 4 11/32	80 3 5/32	16 5/8	13 1/2	29 1 5/32	16 5/8	46.1 1 13/16	46.8	16.7 0.657	41 1.614	M14 1/2
30 1 1/16 1 1/8 1 3/16	UELF306D1W3 UELF306-101D1W3 UELF306-102D1W3 UELF306-103D1W3	125 4 29/32	95 3 47/64	18 45/64	15 19/32	32 1 1/4	16 5/8	50.5 1 63/64	50	17.5 0.689	49 1.929	M14 1/2
35 1 1/4 1 5/16 1 3/8 1 7/16	UELF307D1W3 UELF307-104D1W3 UELF307-105D1W3 UELF307-106D1W3 UELF307-107D1W3	135 5 5/16	100 3 15/16	20 25/32	16 5/8	36 1 13/32	19 3/4	53.3 2 3/32	51.6	18.3 0.720	—	M16 5/8
40 1 1/2 1 9/16	UELF308D1W3 UELF308-108D1W3 UELF308-109D1W3	150 5 29/32	112 4 13/32	23 29/32	17 21/32	40 1 9/16	19 3/4	60.3 2 3/8	57.1	19.8 0.780	—	M16 5/8
45 1 5/8 1 11/16 1 3/4	UELF309D1W3 UELF309-110D1W3 UELF309-111D1W3 UELF309-112D1W3	160 6 5/16	125 4 59/64	25 63/64	18 23/32	44 1 23/32	19 3/4	63.9 2 33/64	58.7	19.8 0.780	—	M16 5/8
50 1 13/16 1 7/8 1 15/16	UELF310D1W3 UELF310-113D1W3 UELF310-114D1W3 UELF310-115D1W3	175 6 7/8	132 5 13/64	28 1 7/64	19 3/4	48 1 7/8	23 29/32	70 2 3/4	66.6	24.6 0.969	—	M20 3/4

Notes ⁽¹⁾ These numbers indicate relubricatable type. If maintenance free type is needed, please order without suffix "D1".

⁽²⁾ Inner race face does not protrude from the housing face except UELF305 and UELF316.

Remarks Please refer to page A21 for size of grease fitting

Bearing number	Housing number	Mass of unit kg lb
UELF305D1W3	F305D1	1.2
UELF305-013D1W3	F305D1	2.6
UELF305-014D1W3	F305D1	
UELF305-015D1W3	F305D1	
UELF305-100D1W3	F305D1	
UELF306D1W3	F306D1	1.8
UELF306-101D1W3	F306D1	4.0
UELF306-102D1W3	F306D1	
UELF306-103D1W3	F306D1	
UELF307D1W3	F307D1	2.2
UELF307-104D1W3	F307D1	4.9
UELF307-105D1W3	F307D1	
UELF307-106D1W3	F307D1	
UELF307-107D1W3	F307D1	
UELF308D1W3	F308D1	2.9
UELF308-108D1W3	F308D1	6.4
UELF308-109D1W3	F308D1	
UELF309D1W3	F309D1	3.6
UELF309-110D1W3	F309D1	7.9
UELF309-111D1W3	F309D1	
UELF309-112D1W3	F309D1	
UELF310D1W3	F310D1	4.6
UELF310-113D1W3	F310D1	10
UELF310-114D1W3	F310D1	
UELF310-115D1W3	F310D1	

Square flanged unit, cast housing Eccentric locking collar type

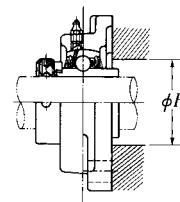
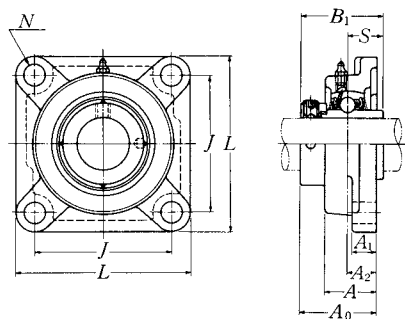

Shaft dia. mm inch	Unit number ⁽¹⁾⁽²⁾	Nominal dimensions										Bolt size mm inch
		L	J	A ₂	A ₁	mm		inch		A ₀	B ₁	
55	UELF311D1W3	185	140	30	20	52	23	75.2	73	27.8	—	M20
2	UELF311-200D1W3											
2 1/16	UELF311-201D1W3											
2 1/8	UELF311-202D1W3	7 9/32	5 33/64	1 3/16	25/32	2 1/16	29/32	2 61/64	2.874	1.094	—	3/4
2 3/16	UELF311-203D1W3											
60	UELF312D1W3	195	150	33	22	56	23	81.45	79.4	30.95	—	M20
2 1/4	UELF312-204D1W3											
2 5/16	UELF312-205D1W3											
2 3/8	UELF312-206D1W3	7 11/16	5 29/32	1 19/64	7/8	2 7/32	29/32	3 13/64	3.126	1.219	—	3/4
2 7/16	UELF312-207D1W3											
65	UELF313D1W3	208	166	33	22	58	23	86.15	85.7	32.55	93	M20
2 1/2	UELF313-208D1W3											
2 9/16	UELF313-209D1W3	8 3/16	6 17/32	1 19/64	7/8	2 9/32	29/32	3 25/64	3.374	1.281	3.661	3/4
70	UELF314D1W3	226	178	36	25	61	25	93.95	92.1	34.15	—	M22
2 5/8	UELF314-210D1W3											
2 11/16	UELF314-211D1W3											
2 3/4	UELF314-212D1W3	8 29/32	6 1/64	1 27/64	31/32	2 13/32	63/64	3 45/64	3.626	1.344	—	7/8
75	UELF315D1W3	236	184	39	25	66	25	101.7	100	37.3	106	M22
2 13/16	UELF315-213D1W3											
2 7/8	UELF315-214D1W3											
2 15/16	UELF315-215D1W3	9 9/32	7 1/4	1 17/32	31/32	2 19/32	63/64	4	3.937	1.469	4.173	7/8
3	UELF315-300D1W3											
80	UELF316D1W3	250	196	38	27	68	31	103.9	106.4	40.5	112	M27
3 1/16	UELF316-301D1W3											
3 1/8	UELF316-302D1W3	9 27/32	7 23/32	1 1/2	1 1/16	2 11/16	1 7/32	4 3/32	4.189	1.594	4.409	1
3 3/16	UELF316-303D1W3											

Bearing number	Housing number	Mass of unit kg lb
UELF311D1W3	F311D1	5.6
UELF311-200D1W3	F311D1	
UELF311-201D1W3	F311D1	12
UELF311-202D1W3	F311D1	
UELF311-203D1W3	F311D1	
UELF312D1W3	F312D1	6.7
UELF312-204D1W3	F312D1	
UELF312-205D1W3	F312D1	15
UELF312-206D1W3	F312D1	
UELF312-207D1W3	F312D1	
UELF313D1W3	F313D1	8.4
UELF313-208D1W3	F313D1	19
UELF313-209D1W3	F313D1	
UELF314D1W3	F314D1	10
UELF314-210D1W3	F314D1	
UELF314-211D1W3	F314D1	22
UELF314-212D1W3	F314D1	
UELF315D1W3	F315D1	12
UELF315-213D1W3	F315D1	
UELF315-214D1W3	F315D1	26
UELF315-215D1W3	F315D1	
UELF315-300D1W3	F315D1	
UELF316D1W3	F316D1	15
UELF316-301D1W3	F316D1	
UELF316-302D1W3	F316D1	33
UELF316-303D1W3	F316D1	

Notes (1) These numbers indicate relubricatable type. If maintenance free type is needed, please order without suffix "D1".

(2) Inner race face does not protrude from the housing face except UELF305 and UELF316.

Remarks Please refer to page A21 for size of grease fitting

UELF3

Square flanged unit, cast housing
Eccentric locking collar type

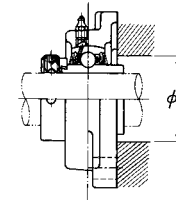
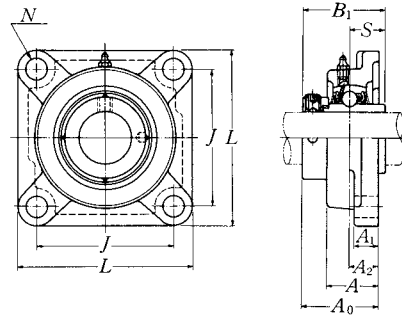

Shaft dia. mm inch	Unit number ⁽¹⁾⁽²⁾	Nominal dimensions										Bolt size mm inch
		L	J	A ₂	A ₁	mm inch		A ₀	B ₁	S	F min.	
85 3 1/4	UELF317D1W3	260	204	44	27	74	31	111.45	109.5	42.05	119	M27
3 7/16	UELF317-304D1W3	10 1/4	8 1/2	1 47/64	1 1/16	2 29/32	1 1/32	4 25/64	4.311	1.656	4.685	1
3 5/16	UELF317-305D1W3											
3 7/16	UELF317-307D1W3											
90 3 7/16	UELF318D1W3	280	216	44	30	76	35	116.25	115.9	43.65	125	M30
3 1/2	UELF318-307D1W3	11 1/2	8 1/2	1 47/64	1 3/16	3	1 3/8	4 37/64	4.563	1.719	4.921	1 1/8
	UELF318-308D1W3											
95 3 5/8	UELF319D1W3	290	228	59	30	94	35	142.4	122.3	38.9	—	M30
3 11/16	UELF319-310D1W3	11 13/32	8 31/32	2 21/64	1 3/16	3 11/16	1 3/8	5 39/64	4.815	1.531	—	1 1/8
3 3/4	UELF319-311D1W3											
	UELF319-312D1W3											
100 3 3/16	UELF320D1W3	310	242	59	32	94	38	137.6	128.6	50	—	M33
3 7/8	UELF320-313D1W3	12 7/32	9 7/32	2 21/64	1 1/4	3 11/16	1 1/2	5 27/64	5.063	1.969	—	1 1/4
3 15/16	UELF320-314D1W3											
4	UELF320-315D1W3											
	UELF320-400D1W3											
105	UELF321D1W3	310	242	59	32	94	38	150.3	139.7	48.4	—	M33
110	UELF322D1W3	340	266	60	35	96	41	152.1	141.3	49.2	—	M36

Notes (1) These numbers indicate relubricatable type. If maintenance free type is needed, please order without suffix "D1".

(2) Inner race face does not protrude from the housing face except UELF305 and UELF316.

Remarks Please refer to page A21 for size of grease fitting

Bearing number	Housing number	Mass of unit kg lb
UEL317D1W3	F317D1	16
UEL317-304D1W3	F317D1	35
UEL317-305D1W3	F317D1	35
UEL317-307D1W3	F317D1	35
UEL318D1W3	F318D1	20
UEL318-308D1W3	F318D1	44
UEL318-308D1W3	F318D1	44
UEL319D1W3	F319D1	24
UEL319-310D1W3	F319D1	53
UEL319-311D1W3	F319D1	53
UEL319-312D1W3	F319D1	53
UEL320D1W3	F320D1	29
UEL320-313D1W3	F320D1	64
UEL320-314D1W3	F320D1	64
UEL320-315D1W3	F320D1	64
UEL320-400D1W3	F320D1	64
UEL321D1W3	F321D1	28
UEL322D1W3	F322D1	37

Square flanged unit, cast housing Eccentric locking collar type

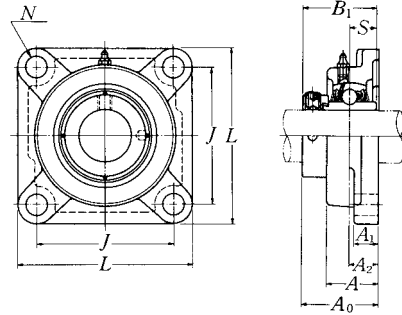

Shaft dia. mm inch	Unit number (1)	Nominal dimensions									Bolt size mm inch
		L	J	A ₂	A ₁	A	N	A ₀	B ₁	S	
20 3/4	UEL204D1W3	86	63.5	19	15	29.5	11.5	45.6	43.7	17.1	M10
	UEL204-012D1W3	3 3/8	2 1/2	3/4	19/32	1 5/32	29/64	1 51/64	1.720	0.673	3/8
25 13/16 7/8 15/16	UEL205D1W3	96	70	19	15	30	11.5	45.95	44.4	17.45	M10
	UEL205-013D1W3	3 25/32	2 3/4	3/4	19/32	1 3/16	29/64	1 13/16	1.748	0.687	3/8
	UEL205-014D1W3										
	UEL205-015D1W3										
1	UEL205-100D1W3										
30 1 1/16 1 1/8 1 3/16 1 1/4	UEL206D1W3	109	82.5	20	16	33	11.5	50.15	48.4	18.25	M10
	UEL206-101D1W3	4 9/32	3 1/4	25/32	5/8	1 5/16	29/64	1 31/32	1.906	0.719	3/8
	UEL206-102D1W3										
	UEL206-103D1W3										
1 1/4	UEL206-104D1W3										
35 1 1/4 1 5/16 1 3/8 1 7/16	UEL207D1W3	118	92	21	17	36	14	53.3	51.1	18.8	M12
	UEL207-104D1W3	4 21/32	3 5/8	53/64	21/32	1 13/32	35/64	2 3/32	2.012	0.740	1/2
	UEL207-105D1W3										
	UEL207-106D1W3										
1 7/16	UEL207-107D1W3										
40 1 1/2 1 9/16	UEL208D1W3	131	101.5	24	17	39	14	58.9	56.3	21.4	M12
	UEL208-108D1W3	5 5/32	4	15/16	21/32	1 17/32	35/64	2 5/16	2.217	0.843	1/2
	UEL208-109D1W3										
45 1 5/8 1 11/16 1 3/4	UEL209D1W3	137	105	24	18	40	16	58.9	56.3	21.4	M14
	UEL209-110D1W3	5 13/32	4 9/64	15/16	23/32	1 9/16	5/8	2 5/16	2.217	0.843	1/2
	UEL209-111D1W3										
	UEL209-112D1W3										
1 3/4	UEL209-112D1W3										
50 1 13/16 1 7/8 1 15/16 2	UEL210D1W3	144	111	28	20	46	18	66.1	62.7	24.6	M16
	UEL210-113D1W3	5 21/32	4 3/8	1 7/64	25/32	1 13/16	45/64	2 39/64	2.469	0.969	5/8
	UEL210-114D1W3										
	UEL210-115D1W3										
2	UEL210-200D1W3										

Note (1) These numbers indicate relubricatable type. If maintenance free type is needed, please order without suffix "D1".

Remarks Please refer to page A21 for size of grease fitting.

Bearing number	Housing number	Mass of unit kg lb
UEL204D1W3	FU204D1	0.8
UEL204-012D1W3	FU204D1	1.8
UEL205D1W3	FU205D1	1.0
UEL205-013D1W3	FU205D1	2.2
UEL205-014D1W3	FU205D1	
UEL205-015D1W3	FU205D1	
UEL205-100D1W3	FU205D1	
UEL206D1W3	FU206D1	1.4
UEL206-101D1W3	FU206D1	3.1
UEL206-102D1W3	FU206D1	
UEL206-103D1W3	FU206D1	
UEL206-104D1W3	FU206D1	
UEL207D1W3	FU207D1	1.7
UEL207-104D1W3	FU207D1	3.7
UEL207-105D1W3	FU207D1	
UEL207-106D1W3	FU207D1	
UEL207-107D1W3	FU207D1	
UEL208D1W3	FU208D1	2.2
UEL208-108D1W3	FU208D1	4.9
UEL208-109D1W3	FU208D1	
UEL209D1W3	FU209D1	2.4
UEL209-110D1W3	FU209D1	5.3
UEL209-111D1W3	FU209D1	
UEL209-112D1W3	FU209D1	
UEL210D1W3	FU210D1	2.9
UEL210-113D1W3	FU210D1	6.4
UEL210-114D1W3	FU210D1	
UEL210-115D1W3	FU210D1	
UEL210-200D1W3	FU210D1	

Square flanged unit, cast housing Eccentric locking collar type

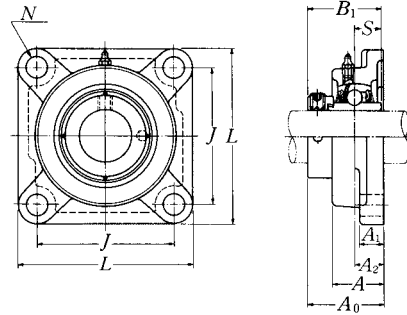

Shaft dia. mm inch	Unit number (1)	Nominal dimensions									Bolt size mm inch
		mm inch									
		L	J	A ₂	A ₁	A	N	A ₀	B ₁	S	
55	UELFU211D1W3	163	130	31	21	49	18	74.65	71.4	27.75	M16
2	UELFU211-200D1W3										
2 1/16	UELFU211-201D1W3	6 13/32	5 1/8	1 7/32	13/16	1 15/16	45/64	2 15/16	2.811	1.093	5/8
2 1/8	UELFU211-202D1W3										
2 3/16	UELFU211-203D1W3										
60	UELFU212D1W3	175	143	34	21	53	18	80.85	77.8	30.95	M16
2 1/4	UELFU212-204D1W3										
2 5/16	UELFU212-205D1W3	6 7/8	5 5/8	1 11/32	13/16	2 3/32	45/64	3 3/16	3.063	1.219	5/8
2 3/8	UELFU212-206D1W3										
2 7/16	UELFU212-207D1W3										
65	UELFU213D1W3	187	149	38	22	59	20.5	89.55	85.7	34.15	M18
2 1/2	UELFU213-208D1W3										
2 5/16	UELFU213-209D1W3	7 3/8	5 55/64	1 1/2	7/8	2 5/16	13/16	3 17/32	3.374	1.344	5/8
70	UELFU214D1W3	193	152	38	22	62	20.5	89.55	85.7	34.15	M18
2 5/8	UELFU214-210D1W3										
2 11/16	UELFU214-211D1W3	7 19/32	5 63/64	1 1/2	7/8	2 7/16	13/16	3 17/32	3.374	1.344	5/8
2 3/4	UELFU214-212D1W3										
75	UELFU215D1W3	200	159	41	22	64	20.5	95.7	92	37.3	M18
2 13/16	UELFU215-213D1W3										
2 7/8	UELFU215-214D1W3	7 7/8	6 17/64	1 39/64	7/8	2 33/64	13/16	3 49/64	3.622	1.469	5/8
2 15/16	UELFU215-215D1W3										
3	UELFU215-300D1W3										

Note (1) These numbers indicate relubricatable type. If maintenance free type is needed, please order without suffix "D1".
Remarks Please refer to page A21 for size of grease fitting.

Bearing number	Housing number	Mass of unit kg lb
UEL211D1W3	FU211D1	3.9
UEL211-200D1W3	FU211D1	
UEL211-201D1W3	FU211D1	8.6
UEL211-202D1W3	FU211D1	
UEL211-203D1W3	FU211D1	
UEL212D1W3	FU212D1	4.7
UEL212-204D1W3	FU212D1	
UEL212-205D1W3	FU212D1	10
UEL212-206D1W3	FU212D1	
UEL212-207D1W3	FU212D1	
UEL213D1W3	FU213D1	6.3
UEL213-208D1W3	FU213D1	14
UEL213-209D1W3	FU213D1	
UEL214D1W3	FU214D1	6.7
UEL214-210D1W3	FU214D1	
UEL214-211D1W3	FU214D1	15
UEL214-212D1W3	FU214D1	
UEL215D1W3	FU215D1	7.0
UEL215-213D1W3	FU215D1	
UEL215-214D1W3	FU215D1	15
UEL215-215D1W3	FU215D1	
UEL215-300D1W3	FU215D1	

Square flanged unit, cast housing with spigot joint Eccentric locking collar type

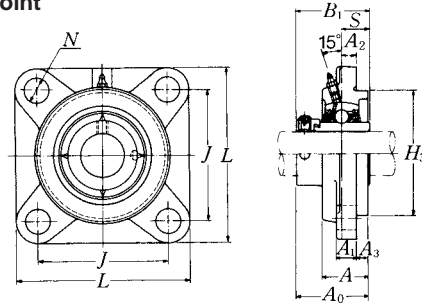

Shaft dia. mm inch	Unit number (1)	Nominal dimensions											Bolt size mm inch
		mm inch											
		L	J	A ₂	N	A ₃	A ₁	A	H ₃	A ₀	B ₁	S	
25	UELFS305D1W3	110	80	9	16	7	13	29	80	46.1	46.8	16.7	M14
$\frac{13}{16}$	UELFS305-013D1W3												
$\frac{7}{8}$	UELFS305-014D1W3	$4\frac{11}{32}$	$3\frac{5}{32}$	$\frac{23}{64}$	$\frac{5}{8}$	$\frac{9}{32}$	$\frac{1}{2}$	$1\frac{9}{64}$	3.1496	$1\frac{19}{16}$	1.843	0.657	$\frac{1}{2}$
$\frac{15}{16}$	UELFS305-015D1W3												
1	UELFS305-100D1W3												
30	UELFS306D1W3	125	95	10	16	8	15	32	90	50.5	50	17.5	M14
$1\frac{1}{16}$	UELFS306-101D1W3												
$1\frac{1}{8}$	UELFS306-102D1W3	$4\frac{29}{32}$	$3\frac{47}{64}$	$\frac{25}{64}$	$\frac{5}{8}$	$\frac{5}{16}$	$\frac{19}{32}$	$1\frac{17}{64}$	3.5433	$1\frac{69}{64}$	1.969	0.689	$\frac{1}{2}$
$1\frac{3}{16}$	UELFS306-103D1W3												
35	UELFS307D1W3	135	100	11	19	9	16	36	100	53.3	51.6	18.3	M16
$1\frac{1}{4}$	UELFS307-104D1W3												
$1\frac{5}{16}$	UELFS307-105D1W3	$5\frac{5}{16}$	$3\frac{15}{16}$	$\frac{7}{16}$	$\frac{3}{4}$	$\frac{23}{64}$	$\frac{5}{8}$	$1\frac{13}{32}$	3.9370	$2\frac{3}{32}$	2.031	0.720	$\frac{5}{8}$
$1\frac{3}{8}$	UELFS307-106D1W3												
$1\frac{7}{16}$	UELFS307-107D1W3												
40	UELFS308D1W3	150	112	13	19	10	17	40	115	60.3	57.1	19.8	M16
$1\frac{1}{2}$	UELFS308-108D1W3												
$1\frac{9}{16}$	UELFS308-109D1W3	$5\frac{29}{32}$	$4\frac{13}{32}$	$\frac{33}{64}$	$\frac{3}{4}$	$\frac{25}{64}$	$\frac{21}{32}$	$1\frac{9}{16}$	4.5276	$2\frac{3}{8}$	2.248	0.780	$\frac{5}{8}$
45	UELFS309D1W3	160	125	14	19	11	18	44	125	63.9	58.7	19.8	M16
$1\frac{5}{8}$	UELFS309-110D1W3												
$1\frac{11}{16}$	UELFS309-111D1W3	$6\frac{5}{16}$	$4\frac{59}{64}$	$\frac{35}{64}$	$\frac{3}{4}$	$\frac{7}{16}$	$\frac{23}{32}$	$1\frac{47}{64}$	4.9213	$2\frac{33}{64}$	2.311	0.780	$\frac{5}{8}$
$1\frac{3}{4}$	UELFS309-112D1W3												
50	UELFS310D1W3	175	132	16	23	12	19	48	140	70	66.6	24.6	M20
$1\frac{3}{16}$	UELFS310-113D1W3												
$1\frac{7}{8}$	UELFS310-114D1W3	$6\frac{7}{8}$	$5\frac{19}{64}$	$\frac{5}{8}$	$\frac{29}{32}$	$\frac{15}{32}$	$\frac{3}{4}$	$1\frac{57}{64}$	5.5118	$2\frac{3}{4}$	2.622	0.969	$\frac{3}{4}$
$1\frac{15}{16}$	UELFS310-115D1W3												

Note (1) These numbers indicate relubricatable type. If maintenance free type is needed, please order without suffix "D1".

Remarks Please refer to page A21 for size of grease fitting.

Bearing number	Housing number	Mass of unit kg lb
UEL305D1W3	FS305D1	1.3
UEL305-013D1W3	FS305D1	
UEL305-014D1W3	FS305D1	2.9
UEL305-015D1W3	FS305D1	
UEL305-100D1W3	FS305D1	
UEL306D1W3	FS306D1	1.9
UEL306-101D1W3	FS306D1	
UEL306-102D1W3	FS306D1	4.2
UEL306-103D1W3	FS306D1	
UEL307D1W3	FS307D1	2.3
UEL307-104D1W3	FS307D1	
UEL307-105D1W3	FS307D1	5.1
UEL307-106D1W3	FS307D1	
UEL307-107D1W3	FS307D1	
UEL308D1W3	FS308D1	3.3
UEL308-108D1W3	FS308D1	
UEL308-109D1W3	FS308D1	7.3
UEL309D1W3	FS309D1	4.0
UEL309-110D1W3	FS309D1	
UEL309-111D1W3	FS309D1	8.8
UEL309-112D1W3	FS309D1	
UEL310D1W3	FS310D1	5.2
UEL310-113D1W3	FS310D1	
UEL310-114D1W3	FS310D1	11
UEL310-115D1W3	FS310D1	

Square flanged unit, cast housing with spigot joint Eccentric locking collar type

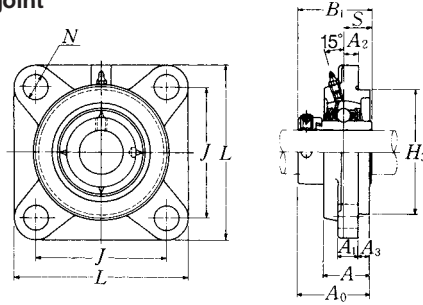

Shaft dia. mm inch	Unit number (1)	Nominal dimensions											Bolt size mm inch
		mm inch											
		L	J	A ₂	N	A ₃	A ₁	A	H ₃	A ₀	B ₁	S	
55 2 2 1/16 2 1/8 2 3/16	UELFS311D1W3 UELFS311-200D1W3 UELFS311-201D1W3 UELFS311-202D1W3 UELFS311-203D1W3	185 7 9/32	140 5 33/64	17 43/64	23 29/32	13 33/64	20 25/32	52 2 3/64	150 5.9055	75.2 2 61/64	73 2.874	27.8 1.094	M20 3/4
60 2 1/4 2 5/16 2 3/8 2 7/16	UELFS312D1W3 UELFS312-204D1W3 UELFS312-205D1W3 UELFS312-206D1W3 UELFS312-207D1W3	195 7 11/16	150 5 29/32	19 3/4	23 29/32	14 35/64	22 7/8	56 2 13/16	160 6.2992	81.45 3 13/64	79.4 3.126	30.95 1.219	M20 3/4
65 2 1/2 2 9/16	UELFS313D1W3 UELFS313-208D1W3 UELFS313-209D1W3	208 8 3/16	166 6 17/32	15 19/32	23 29/32	18 45/64	22 7/8	58 2 9/32	175 6.8898	86.15 3 25/64	85.7 3.374	32.55 1.281	M20 3/4
70 2 5/8 2 11/16 2 3/4	UELFS314D1W3 UELFS314-210D1W3 UELFS314-211D1W3 UELFS314-212D1W3	226 8 29/32	178 7 1/64	18 45/64	25 63/64	18 45/64	25 31/32	61 2 13/32	185 7.2835	93.95 3 45/64	92.1 3.626	34.15 1.344	M22 7/8
75 2 3/16 2 7/8 2 9/16 3	UELFS315D1W3 UELFS315-213D1W3 UELFS315-214D1W3 UELFS315-215D1W3 UELFS315-300D1W3	236 9 9/32	184 7 1/4	21 53/64	25 63/64	18 45/64	25 31/32	66 2 19/32	200 7.8740	101.7 4	100 3.937	37.3 1.469	M22 7/8
80 3 1/16 3 1/8 3 3/16	UELFS316D1W3 UELFS316-301D1W3 UELFS316-302D1W3 UELFS316-303D1W3	250 9 27/32	196 7 23/32	18 45/64	31 1 7/32	20 25/32	27 1 1/16	68 2 43/64	210 8.2677	103.9 4 3/32	106.4 4.189	40.5 1.594	M27 1

Note (1) These numbers indicate relubricatable type. If maintenance free type is needed, please order without suffix "D1".
Remarks Please refer to page A21 for size of grease fitting.

Bearing number	Housing number	Mass of unit kg lb
UEL311D1W3	FS311D1	6.2
UEL311-200D1W3	FS311D1	14
UEL311-201D1W3	FS311D1	
UEL311-202D1W3	FS311D1	
UEL311-203D1W3	FS311D1	
UEL312D1W3	FS312D1	7.4
UEL312-204D1W3	FS312D1	16
UEL312-205D1W3	FS312D1	
UEL312-206D1W3	FS312D1	
UEL312-207D1W3	FS312D1	
UEL313D1W3	FS313D1	9.0
UEL313-208D1W3	FS313D1	20
UEL313-209D1W3	FS313D1	
UEL314D1W3	FS314D1	11
UEL314-210D1W3	FS314D1	24
UEL314-211D1W3	FS314D1	
UEL314-212D1W3	FS314D1	
UEL315D1W3	FS315D1	13
UEL315-213D1W3	FS315D1	29
UEL315-214D1W3	FS315D1	
UEL315-215D1W3	FS315D1	
UEL315-300D1W3	FS315D1	
UEL316D1W3	FS316D1	16
UEL316-301D1W3	FS316D1	35
UEL316-302D1W3	FS316D1	
UEL316-303D1W3	FS316D1	

Square flanged unit, cast housing with spigot joint Eccentric locking collar type

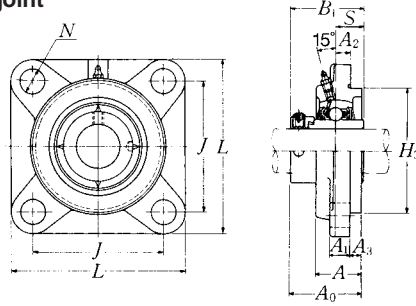

Shaft dia. mm inch	Unit number (1)	Nominal dimensions											Bolt size mm inch
		mm inch											
		L	J	A ₂	N	A ₃	A ₁	A	H ₃	A ₀	B ₁	S	
85 3 1/4	UELFS317D1W3	260	204	24	31	20	27	74	220	111.45	109.5	42.05	M27
3 7/16	UELFS317-304D1W3	10 1/4	8 1/32	15/16	1 1/32	25/32	1 1/16	2 29/32	8.6614	4 25/64	4.311	1.656	1
3 7/16	UELFS317-305D1W3												
3 7/16	UELFS317-307D1W3												
90 3 7/16	UELFS318D1W3	280	216	24	35	20	30	76	240	116.25	115.9	43.65	M30
3 1/2	UELFS318-307D1W3	11 1/32	8 1/2	15/16	1 3/8	25/32	1 3/16	2 63/64	9.4488	4 37/64	4.563	1.719	1 1/8
3 1/2	UELFS318-308D1W3												
95 3 5/8	UELFS319D1W3	290	228	39	35	20	30	94	250	142.4	122.3	38.9	M30
3 11/16	UELFS319-310D1W3	11 13/32	8 31/32	1 17/32	1 3/8	25/32	1 3/16	3 45/64	9.8425	5 39/64	4.815	1.531	1 1/8
3 3/4	UELFS319-311D1W3												
3 3/4	UELFS319-312D1W3												
100 3 13/16	UELFS320D1W3	310	242	39	38	20	32	94	260	137.6	128.6	50	M33
3 7/8	UELFS320-313D1W3	12 7/32	9 17/32	1 17/32	1 1/2	25/32	1 1/4	3 45/64	10.2362	5 27/64	5.063	1.969	1 1/4
3 15/16	UELFS320-314D1W3												
4	UELFS320-315D1W3												
4	UELFS320-400D1W3												
105	UELFS321D1W3	310	242	39	38	20	32	94	260	150.3	139.7	48.4	M33
110	UELFS322D1W3	340	266	35	41	25	35	96	300	152.1	141.3	49.2	M36

Note (1) These numbers indicate relubricatable type. If maintenance free type is needed, please order without suffix "D1".
Remarks Please refer to page A21 for size of grease fitting.

Bearing number	Housing number	Mass of unit kg lb
UEL317D1W3	FS317D1	18
UEL317-304D1W3	FS317D1	40
UEL317-305D1W3	FS317D1	40
UEL317-307D1W3	FS317D1	40
UEL318D1W3	FS318D1	22
UEL318-307D1W3	FS318D1	49
UEL318-308D1W3	FS318D1	49
UEL319D1W3	FS319D1	26
UEL319-310D1W3	FS319D1	57
UEL319-311D1W3	FS319D1	57
UEL319-312D1W3	FS319D1	57
UEL320D1W3	FS320D1	31
UEL320-313D1W3	FS320D1	68
UEL320-314D1W3	FS320D1	68
UEL320-315D1W3	FS320D1	68
UEL320-400D1W3	FS320D1	68
UEL321D1W3	FS321D1	31
UEL322D1W3	FS322D1	41

Round flanged unit, cast housing with spigot joint Eccentric locking collar type

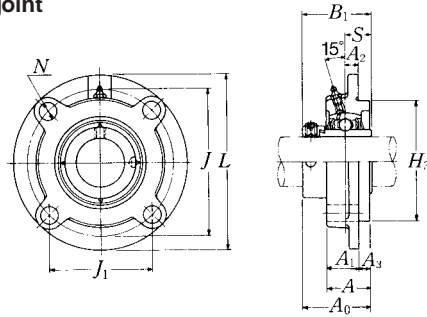

Shaft dia. mm inch	Unit number (1)	Nominal dimensions													Bolt size mm inch
		mm inch													
		L	J	(J ₁)	A ₂	N	A ₃	A ₁	A	H ₃	A ₀	B ₁	S		
20 3/4	UELFC204D1W3	100	78	55.2	10	12	5	20.5	25.5	62	41.6	43.7	17.1	M10	
	UELFC204-012D1W3	3 ¹⁵ / ₁₆	3 ⁵ / ₆₄	2 ¹¹ / ₆₄	25 ²⁵ / ₆₄	15 ¹³ / ₃₂	13 ¹³ / ₆₄	13 ¹³ / ₁₆	1	2.4409	1 ⁴¹ / ₆₄	1.720	0.673	3/8	
25 13/16 7/8 15/16 1	UELFC205D1W3	115	90	63.6	10	12	6	21	27	70	42.95	44.4	17.45	M10	
	UELFC205-013D1W3														
	UELFC205-014D1W3	4 ¹⁷ / ₃₂	3 ³⁵ / ₆₄	2 1/2	25 ²⁵ / ₆₄	15 ¹⁵ / ₃₂	15 ¹⁵ / ₆₄	13 ¹³ / ₁₆	1 1/16	2.7559	1 ¹¹ / ₁₆	1.748	0.687	3/8	
	UELFC205-015D1W3														
	UELFC205-100D1W3														
30 1 1/16 1 1/8 1 3/16 1 1/4	UELFC206D1W3	125	100	70.7	10	12	8	23	31	80	48.15	48.4	18.25	M10	
	UELFC206-101D1W3														
	UELFC206-102D1W3	4 ²⁹ / ₃₂	3 ¹⁵ / ₁₆	2 ²⁵ / ₃₂	25 ²⁵ / ₆₄	15 ¹⁵ / ₃₂	5 ⁵ / ₁₆	29 ²⁹ / ₃₂	1 7/32	3.1496	1 ⁵⁷ / ₆₄	1.906	0.719	3/8	
	UELFC206-103D1W3														
	UELFC206-104D1W3														
35 1 1/4 1 5/16 1 3/8 1 7/16	UELFC207D1W3	135	110	77.8	11	14	8	26	34	90	51.3	51.1	18.8	M12	
	UELFC207-104D1W3														
	UELFC207-105D1W3	5 ⁵ / ₁₆	4 ²¹ / ₆₄	3 1/16	7 ⁷ / ₁₆	35 ³⁵ / ₆₄	5 ⁵ / ₁₆	1 1/32	1 ¹¹ / ₃₂	3.5433	2 ¹ / ₆₄	2.012	0.740	7/16	
	UELFC207-106D1W3														
	UELFC207-107D1W3														
40 1 1/2 1 9/16	UELFC208D1W3	145	120	84.9	11	14	10	26	36	100	55.9	56.3	21.4	M12	
	UELFC208-108D1W3	5 ²³ / ₃₂	4 ²³ / ₃₂	3 ¹¹ / ₃₂	7 ⁷ / ₁₆	35 ³⁵ / ₆₄	25 ²⁵ / ₆₄	1 1/32	1 ²⁷ / ₆₄	3.9370	2 ¹³ / ₆₄	2.217	0.843	7/16	
	UELFC208-109D1W3														
45 1 5/8 1 11/16 1 3/4	UELFC209D1W3	160	132	93.3	10	16	12	26	38	105	56.9	56.3	21.4	M14	
	UELFC209-110D1W3														
	UELFC209-111D1W3	6 ⁵ / ₁₆	5 ¹³ / ₆₄	3 ⁴³ / ₆₄	25 ²⁵ / ₆₄	5 ⁵ / ₈	15 ¹⁵ / ₃₂	1 1/32	1 1/2	4.1339	2 ¹⁵ / ₆₄	2.217	0.843	1/2	
	UELFC209-112D1W3														
50 1 13/16 1 7/8 1 15/16 2	UELFC210D1W3	165	138	97.6	10	16	12	28	40	110	60.1	62.7	24.6	M14	
	UELFC210-113D1W3														
	UELFC210-114D1W3	6 1/2	5 ⁷ / ₁₆	3 ²⁷ / ₃₂	25 ²⁵ / ₆₄	5 ⁵ / ₈	15 ¹⁵ / ₃₂	1 3/32	1 ³⁷ / ₆₄	4.3307	2 ²³ / ₆₄	2.469	0.969	1/2	
	UELFC210-115D1W3														
	UELFC210-200D1W3														

Note (1) These numbers indicate relubricatable type. If maintenance free type is needed, please order without suffix "D1".

Remarks Please refer to page A21 for size of grease fitting.

Bearing number	Housing number	Mass of unit kg lb
UEL204D1W3	FC204D1	0.8
UEL204-012D1W3	FC204D1	1.8
UEL205D1W3	FC205D1	1.1
UEL205-013D1W3	FC205D1	
UEL205-014D1W3	FC205D1	2.4
UEL205-015D1W3	FC205D1	
UEL205-100D1W3	FC205D1	
UEL206D1W3	FC206D1	1.4
UEL206-101D1W3	FC206D1	
UEL206-102D1W3	FC206D1	3.1
UEL206-103D1W3	FC206D1	
UEL206-104D1W3	FC206D1	
UEL207D1W3	FC207D1	1.8
UEL207-104D1W3	FC207D1	
UEL207-105D1W3	FC207D1	4.0
UEL207-106D1W3	FC207D1	
UEL207-107D1W3	FC207D1	
UEL208D1W3	FC208D1	2.1
UEL208-108D1W3	FC208D1	4.6
UEL208-109D1W3	FC208D1	
UEL209D1W3	FC209D1	2.8
UEL209-110D1W3	FC209D1	
UEL209-111D1W3	FC209D1	6.2
UEL209-112D1W3	FC209D1	
UEL210D1W3	FC210D1	3.1
UEL210-113D1W3	FC210D1	
UEL210-114D1W3	FC210D1	6.8
UEL210-115D1W3	FC210D1	
UEL210-200D1W3	FC210D1	

Round flanged unit, cast housing with spigot joint Eccentric locking collar type

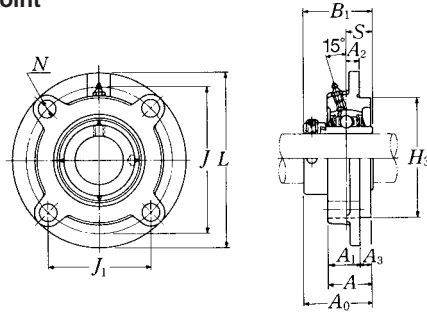

Shaft dia. mm inch	Unit number (1)	Nominal dimensions												Bolt size mm inch
		mm inch												
		L	J	(J ₁)	A ₂	N	A ₃	A ₁	A	H ₃	A ₀	B ₁	S	
55	UELFC211D1W3	185	150	106.1	13	19	12	31	43	125	68.65	71.4	27.75	M16
2	UELFC211-200D1W3													
2 1/16	UELFC211-201D1W3													
2 1/8	UELFC211-202D1W3	7 9/32	5 29/32	4 11/64	33/64	3/4	15/32	1 7/32	1 11/16	4.9213	2 45/64	2.811	1.093	5/8
2 3/16	UELFC211-203D1W3													
60	UELFC212D1W3	195	160	113.1	17	19	12	36	48	135	75.85	77.8	30.95	M16
2 1/4	UELFC212-204D1W3													
2 5/16	UELFC212-205D1W3													
2 3/8	UELFC212-206D1W3	7 11/16	6 19/64	4 29/64	43/64	3/4	15/32	1 13/32	1 57/64	5.3150	2 63/64	3.063	1.219	5/8
2 7/16	UELFC212-207D1W3													
65	UELFC213D1W3	205	170	120.2	16	19	14	36	50	145	81.55	85.7	34.15	M16
2 1/2	UELFC213-208D1W3													
2 5/16	UELFC213-209D1W3	8 1/16	6 11/16	4 47/64	5/8	3/4	35/64	1 13/32	1 31/32	5.7087	3 13/64	3.374	1.344	5/8
70	UELFC214D1W3	215	177	125.2	17	19	14	40	54	150	82.55	85.7	34.15	M16
2 5/8	UELFC214-210D1W3													
2 11/16	UELFC214-211D1W3													
2 3/4	UELFC214-212D1W3	8 15/32	6 31/32	4 59/64	43/64	3/4	35/64	1 37/64	2 1/8	5.9055	3 1/4	3.374	1.344	5/8
75	UELFC215D1W3	220	184	130.1	18	19	16	40	56	160	88.7	92	37.3	M16
2 13/16	UELFC215-213D1W3													
2 7/8	UELFC215-214D1W3													
2 15/16	UELFC215-215D1W3	8 21/32	7 1/4	5 1/8	45/64	3/4	5/8	1 37/64	2 13/64	6.2992	3 31/64	3.622	1.469	5/8
3	UELFC215-300D1W3													

Note (1) These numbers indicate relubricatable type. If maintenance free type is needed, please order without suffix "D1".
Remarks Please refer to page A21 for size of grease fitting.

Bearing number	Housing number	Mass of unit kg lb
UEL211D1W3	FC211D1	4.3
UEL211-200D1W3	FC211D1	
UEL211-201D1W3	FC211D1	9.5
UEL211-202D1W3	FC211D1	
UEL211-203D1W3	FC211D1	
UEL212D1W3	FC212D1	5.2
UEL212-204D1W3	FC212D1	
UEL212-205D1W3	FC212D1	11
UEL212-206D1W3	FC212D1	
UEL212-207D1W3	FC212D1	
UEL213D1W3	FC213D1	6.5
UEL213-208D1W3	FC213D1	14
UEL213-209D1W3	FC213D1	
UEL214D1W3	FC214D1	7.4
UEL214-210D1W3	FC214D1	
UEL214-211D1W3	FC214D1	16
UEL214-212D1W3	FC214D1	
UEL215D1W3	FC215D1	7.8
UEL215-213D1W3	FC215D1	
UEL215-214D1W3	FC215D1	17
UEL215-215D1W3	FC215D1	
UEL215-300D1W3	FC215D1	

Rhombus flanged unit, cast housing Eccentric locking collar type

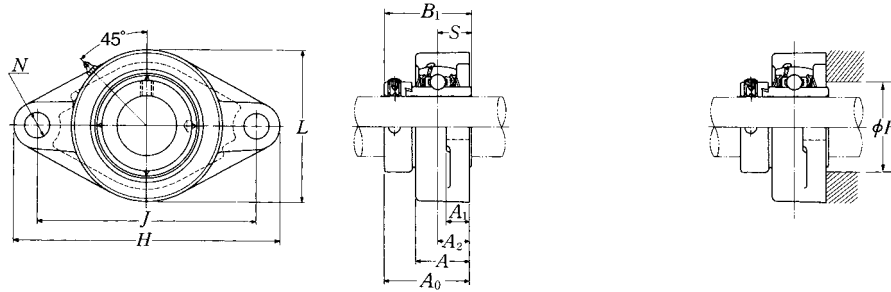

Shaft dia. mm inch	Unit number (1)	Nominal dimensions											Bolt size mm inch
		mm inch											
		H	J	A ₂	A ₁	A	N	L	A ₀	B ₁	S	F min.	
20 3/4	UELFL204D1W3	113	90	15	11	25.5	12	60	41.6	43.7	17.1	34	M10
	UELFL204-012D1W3	4 7/16	3 5/8	19/32	7/16	1	15/32	2 3/8	1 1/4	1.720	0.673	1.339	3/8
25 13/16 7/8 15/16	UELFL205D1W3	130	99	16	13	27	16	68	42.95	44.4	17.45	38	M14
	UELFL205-013D1W3												
	UELFL205-014D1W3												
	UELFL205-015D1W3	5 1/8	3 57/64	5/8	1/2	1 1/16	5/8	2 11/16	1 11/16	1.748	0.687	1.496	1/2
1	UELFL205-100D1W3												
30 1 1/16 1 1/8 1 3/16 1 1/4	UELFL206D1W3	148	117	18	13	31	16	80	48.15	48.4	18.25	45	M14
	UELFL206-101D1W3												
	UELFL206-102D1W3												
	UELFL206-103D1W3	5 13/16	4 39/64	45/64	1/2	1 7/32	5/8	3 5/32	1 57/64	1.906	0.719	1.772	1/2
1 1/4	UELFL206-104D1W3												
35 1 1/4 1 5/16 1 3/8 1 7/16	UELFL207D1W3	161	130	19	15	34	16	90	51.3	51.1	18.8	51	M14
	UELFL207-104D1W3												
	UELFL207-105D1W3												
	UELFL207-106D1W3	6 11/32	5 1/8	3/4	19/32	1 11/32	5/8	3 17/32	2 1/4	2.012	0.740	2.008	1/2
1 7/16	UELFL207-107D1W3												
40 1 1/2 1 9/16	UELFL208D1W3	175	144	21	15	36	16	100	55.9	56.3	21.4	57	M14
	UELFL208-108D1W3												
	UELFL208-109D1W3	6 7/8	5 43/64	53/64	19/32	1 13/32	5/8	3 15/16	2 13/64	2.217	0.843	2.244	1/2
45 1 5/8 1 11/16 1 3/4	UELFL209D1W3	188	148	22	16	38	19	108	56.9	56.3	21.4	62	M16
	UELFL209-110D1W3												
	UELFL209-111D1W3												
	UELFL209-112D1W3	7 13/32	5 53/64	55/64	5/8	1 1/2	3/4	4 1/4	2 15/64	2.217	0.843	2.441	5/8
50 1 13/16 1 7/8 1 15/16 2	UELFL210D1W3	197	157	22	16	40	19	115	60.1	62.7	24.6	67	M16
	UELFL210-113D1W3												
	UELFL210-114D1W3												
	UELFL210-115D1W3	7 3/4	6 3/16	55/64	5/8	1 9/16	3/4	4 17/32	2 23/64	2.469	0.969	2.638	5/8
2	UELFL210-200D1W3												

Note (1) These numbers indicate relubricatable type. If maintenance free type is needed, please order without suffix "D1".

Remarks Please refer to page A21 for size of grease fitting.

Bearing number	Housing number	Mass of unit kg lb
UEL204D1W3	FL204D1	0.5
UEL204-012D1W3	FL204D1	1.1
UEL205D1W3	FL205D1	0.7
UEL205-013D1W3	FL205D1	
UEL205-014D1W3	FL205D1	1.5
UEL205-015D1W3	FL205D1	
UEL205-100D1W3	FL205D1	
UEL206D1W3	FL206D1	1.0
UEL206-101D1W3	FL206D1	
UEL206-102D1W3	FL206D1	2.2
UEL206-103D1W3	FL206D1	
UEL206-104D1W3	FL206D1	
UEL207D1W3	FL207D1	1.3
UEL207-104D1W3	FL207D1	
UEL207-105D1W3	FL207D1	2.9
UEL207-106D1W3	FL207D1	
UEL207-107D1W3	FL207D1	
UEL208D1W3	FL208D1	1.6
UEL208-108D1W3	FL208D1	3.5
UEL208-109D1W3	FL208D1	
UEL209D1W3	FL209D1	2.0
UEL209-110D1W3	FL209D1	
UEL209-111D1W3	FL209D1	4.4
UEL209-112D1W3	FL209D1	
UEL210D1W3	FL210D1	2.2
UEL210-113D1W3	FL210D1	
UEL210-114D1W3	FL210D1	4.9
UEL210-115D1W3	FL210D1	
UEL210-200D1W3	FL210D1	

Rhombus flanged unit, cast housing Eccentric locking collar type

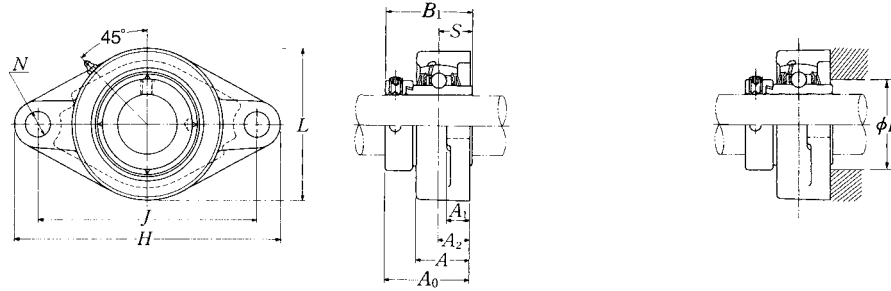

Shaft dia. mm inch	Unit number (1)	Nominal dimensions											Bolt size mm inch
		H	J	A ₂	A ₁	A	N	L	A ₀	B ₁	S	F _{min.}	
55 2 2 1/16 2 1/8 2 3/16	UELFL211D1W3 UELFL211-200D1W3 UELFL211-201D1W3 UELFL211-202D1W3 UELFL211-203D1W3	224	184	25	18	43	19	130	68.65	71.4	27.75	73	M16
		8 13/16	7 1/4	63/64	23/32	1 11/16	3/4	5 1/8	2 45/64	2.811	1.093	2.874	5/8
60 2 1/4 2 5/16 2 3/8 2 7/16	UELFL212D1W3 UELFL212-204D1W3 UELFL212-205D1W3 UELFL212-206D1W3 UELFL212-207D1W3	250	202	29	18	48	23	140	75.85	77.8	30.95	81	M20
		9 27/32	7 61/64	1 9/64	23/32	1 7/8	29/32	5 1/2	2 63/64	3.063	1.219	3.189	3/4
65 2 1/2 2 9/16	UELFL213D1W3 UELFL213-208D1W3 UELFL213-209D1W3	258	210	30	22	50	23	155	81.55	85.7	34.15	87	M20
		10 5/32	8 17/64	1 3/16	7/8	1 31/32	29/32	6 3/32	3 13/64	3.374	1.344	3.425	3/4
70 2 5/8 2 11/16 2 3/4	UELFL214D1W3 UELFL214-210D1W3 UELFL214-211D1W3 UELFL214-212D1W3	265	216	31	22	54	23	160	82.55	85.7	34.15	91	M20
		10 7/16	8 1/2	1 7/32	7/8	2 1/8	29/32	6 5/16	3 1/4	3.374	1.344	3.583	3/4
75 2 13/16 2 7/8 2 15/16 3	UELFL215D1W3 UELFL215-213D1W3 UELFL215-214D1W3 UELFL215-215D1W3 UELFL215-300D1W3	275	225	34	22	56	23	165	88.7	92	37.3	97	M20
		10 13/16	8 55/64	1 11/32	7/8	2 7/32	29/32	6 1/2	3 31/64	3.622	1.469	3.819	3/4

Note (1) These numbers indicate relubricatable type. If maintenance free type is needed, please order without suffix "D1".
Remarks Please refer to page A21 for size of grease fitting.

Bearing number	Housing number	Mass of unit kg lb
UEL211D1W3	FL211D1	3.2
UEL211-200D1W3	FL211D1	7.1
UEL211-201D1W3	FL211D1	
UEL211-202D1W3	FL211D1	
UEL211-203D1W3	FL211D1	
UEL212D1W3	FL212D1	4.1
UEL212-204D1W3	FL212D1	9.0
UEL212-205D1W3	FL212D1	
UEL212-206D1W3	FL212D1	
UEL212-207D1W3	FL212D1	
UEL213D1W3	FL213D1	5.5
UEL213-208D1W3	FL213D1	12
UEL213-209D1W3	FL213D1	
UEL214D1W3	FL214D1	5.8
UEL214-210D1W3	FL214D1	13
UEL214-211D1W3	FL214D1	
UEL214-212D1W3	FL214D1	
UEL215D1W3	FL215D1	6.3
UEL215-213D1W3	FL215D1	14
UEL215-214D1W3	FL215D1	
UEL215-215D1W3	FL215D1	
UEL215-300D1W3	FL215D1	

Rhombus flanged unit, cast housing Eccentric locking collar type

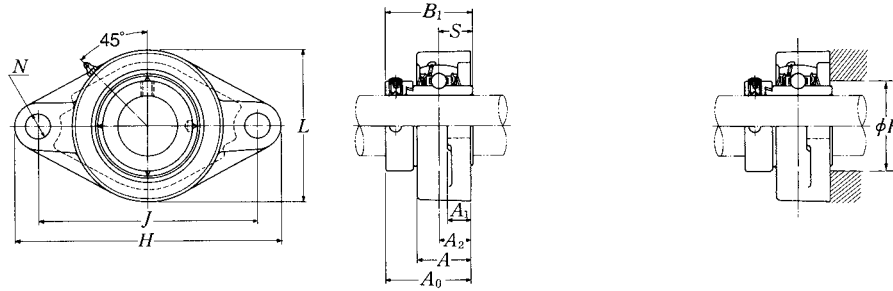

Shaft dia. mm inch	Unit number ⁽¹⁾⁽²⁾	Nominal dimensions											Bolt size mm inch
		H	J	A ₂	A ₁	A	N	L	A ₀	B ₁	S	F min.	
25 1 3/16 7/8 15/16 1	UELFL305D1W3 UELFL305-013D1W3 UELFL305-014D1W3 UELFL305-015D1W3 UELFL305-100D1W3	150	113	16	13	29	19	80	46.1	46.8	16.7	41	M16 5/8
30 1 1/16 1 1/8 1 3/16	UELFL306D1W3 UELFL306-101D1W3 UELFL306-102D1W3 UELFL306-103D1W3	180	134	18	15	32	23	90	50.5	50	17.5	49	M20 3/4
35 1 1/4 1 5/16 1 3/8 1 7/16	UELFL307D1W3 UELFL307-104D1W3 UELFL307-105D1W3 UELFL307-106D1W3 UELFL307-107D1W3	185	141	20	16	36	23	100	53.3	51.6	18.3	—	M20 3/4
40 1 1/2 1 9/16	UELFL308D1W3 UELFL308-108D1W3 UELFL308-109D1W3	200	158	23	17	40	23	112	60.3	57.1	19.8	—	M20 3/4
45 1 5/8 1 11/16 1 3/4	UELFL309D1W3 UELFL309-110D1W3 UELFL309-111D1W3 UELFL309-112D1W3	230	177	25	18	44	25	125	63.9	58.7	19.8	—	M22 7/8
50 1 3/16 1 7/8 1 5/16	UELFL310D1W3 UELFL310-113D1W3 UELFL310-114D1W3 UELFL310-115D1W3	240	187	28	19	48	25	140	70	66.6	24.6	—	M22 7/8

Notes ⁽¹⁾ These numbers indicate relubricatable type. If maintenance free type is needed, please order without suffix "D1".

⁽²⁾ Inner race face does not protrude from the housing face except UELFL305 and UELFL316.

Remarks Please refer to page A21 for size of grease fitting.

Bearing number	Housing number	Mass of unit kg lb
UEL305D1W3 UEL305-013D1W3 UEL305-014D1W3 UEL305-015D1W3 UEL305-100D1W3	FL305D1 FL305D1 FL305D1 FL305D1 FL305D1	1.0 2.2
UEL306D1W3 UEL306-101D1W3 UEL306-102D1W3 UEL306-103D1W3	FL306D1 FL306D1 FL306D1 FL306D1	1.6 3.5
UEL307D1W3 UEL307-104D1W3 UEL307-105D1W3 UEL307-106D1W3 UEL307-107D1W3	FL307D1 FL307D1 FL307D1 FL307D1 FL307D1	1.8 4.0
UEL308D1W3 UEL308-108D1W3 UEL308-109D1W3	FL308D1 FL308D1 FL308D1	2.3 5.1
UEL309D1W3 UEL309-110D1W3 UEL309-111D1W3 UEL309-112D1W3	FL309D1 FL309D1 FL309D1 FL309D1	3.1 6.8
UEL310D1W3 UEL310-113D1W3 UEL310-114D1W3 UEL310-115D1W3	FL310D1 FL310D1 FL310D1 FL310D1	4.2 9.3

Rhombus flanged unit, cast housing Eccentric locking collar type

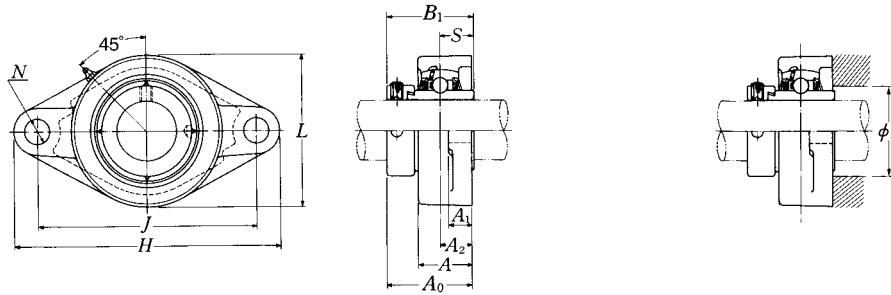

Shaft dia. mm inch	Unit number ⁽¹⁾⁽²⁾	Nominal dimensions											Bolt size mm inch
		H	J	A ₂	A ₁	A	N	L	A ₀	B ₁	S	F min.	
55 2 2 1/16 2 1/8 2 3/16	UELFL311D1W3 UELFL311-200D1W3 UELFL311-201D1W3 UELFL311-202D1W3 UELFL311-203D1W3	250	198	30	20	52	25	150	75.2	73	27.8	—	M22
		9 27/32	7 51/64	1 3/16	25/32	2 1/16	63/64	5 29/32	2 61/64	2.874	1.094	—	7/8
60 2 1/4 2 5/16 2 3/8 2 7/16	UELFL312D1W3 UELFL312-204D1W3 UELFL312-205D1W3 UELFL312-206D1W3 UELFL312-207D1W3	270	212	33	22	56	31	160	81.45	79.4	30.95	—	M27
		10 5/8	8 11/32	1 19/64	7/8	2 7/32	1 1/32	6 5/16	3 13/64	3.126	1.219	—	1
65 2 1/2 2 9/16	UELFL313D1W3 UELFL313-208D1W3 UELFL313-209D1W3	295	240	33	25	58	31	175	86.15	85.7	32.55	93	M27
		11 5/8	9 29/64	1 19/64	31/32	2 9/32	1 7/32	6 7/8	3 25/64	3.374	1.281	3.661	1
70 2 5/8 2 11/16 2 3/4	UELFL314D1W3 UELFL314-210D1W3 UELFL314-211D1W3 UELFL314-212D1W3	315	250	36	28	61	35	185	93.95	92.1	34.15	—	M30
		12 13/32	9 27/32	1 27/64	1 3/32	2 13/32	1 3/8	7 9/32	3 45/64	3.626	1.344	—	1 1/8
75 2 3/16 2 7/8 2 5/16 3	UELFL315D1W3 UELFL315-213D1W3 UELFL315-214D1W3 UELFL315-215D1W3 UELFL315-300D1W3	320	260	39	30	66	35	195	101.7	100	37.3	106	M30
		12 19/32	10 15/64	1 17/32	1 3/16	2 19/32	1 3/8	7 11/16	4	3.937	1.469	4.173	1 1/8
80 3 1/16 3 1/8 3 3/16	UELFL316D1W3 UELFL316-301D1W3 UELFL316-302D1W3 UELFL316-303D1W3	355	285	38	32	68	38	210	103.9	106.4	40.5	112	M33
		13 31/32	11 7/32	1 1/2	1 1/4	2 11/16	1 1/2	8 9/32	4 3/32	4.189	1.594	4.409	1 1/4

Notes (1) These numbers indicate relubricatable type. If maintenance free type is needed, please order without suffix "D1".

(2) Inner race face does not protrude from the housing face except UELFL305 and UELFL316.

Remarks Please refer to page A21 for size of grease fitting.

Bearing number	Housing number	Mass of unit kg lb
UEL311D1W3	FL311D1	4.9
UEL311-200D1W3	FL311D1	11
UEL311-201D1W3	FL311D1	
UEL311-202D1W3	FL311D1	
UEL311-203D1W3	FL311D1	
UEL312D1W3	FL312D1	6.1
UEL312-204D1W3	FL312D1	13
UEL312-205D1W3	FL312D1	
UEL312-206D1W3	FL312D1	
UEL312-207D1W3	FL312D1	
UEL313D1W3	FL313D1	8.0
UEL313-208D1W3	FL313D1	18
UEL313-209D1W3	FL313D1	
UEL314D1W3	FL314D1	9.2
UEL314-210D1W3	FL314D1	20
UEL314-211D1W3	FL314D1	
UEL314-212D1W3	FL314D1	
UEL315D1W3	FL315D1	10
UEL315-213D1W3	FL315D1	22
UEL315-214D1W3	FL315D1	
UEL315-215D1W3	FL315D1	
UEL315-300D1W3	FL315D1	
UEL316D1W3	FL316D1	14
UEL316-301D1W3	FL316D1	31
UEL316-302D1W3	FL316D1	
UEL316-303D1W3	FL316D1	

Rhombus flanged unit, cast housing Eccentric locking collar type

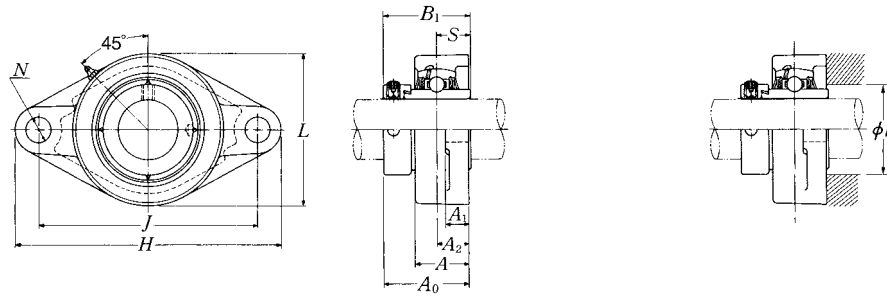

Shaft dia. mm inch	Unit number ⁽¹⁾⁽²⁾	Nominal dimensions											Bolt size mm inch
		H	J	A ₂	A ₁	A	N	L	A ₀	B ₁	S	F min.	
85 3 1/4 3 5/16 3 7/16	UELFL317D1W3 UELFL317-304D1W3 UELFL317-305D1W3 UELFL317-306D1W3	370 14 9/16	300 11 13/16	44 1 47/64	32 1 1/4	74 2 29/32	38 1 1/2	220 8 21/32	111.45 4 25/64	109.5 4.311	42.05 1.656	119 4.685	M33 1 1/4
90 3 7/16 3 1/2	UELFL318D1W3 UELFL318-307D1W3 UELFL318-308D1W3	385 15 5/32	315 12 13/32	44 1 47/64	36 1 13/32	76 3	38 1 1/2	235 9 1/4	116.25 4 37/64	115.9 4.563	43.65 1.719	125 4.921	M33 1 1/4
95 3 5/8 3 11/16 3 3/4	UELFL319D1W3 UELFL319-310D1W3 UELFL319-311D1W3 UELFL319-312D1W3	405 15 15/16	330 12 63/64	59 2 21/64	40 1 9/16	94 3 11/16	41 1 39/64	250 9 27/32	142.4 5 39/64	122.3 4.815	38.9 1.531	—	M36 1 3/8
100 3 13/16 3 7/8 3 15/16 4	UELFL320D1W3 UELFL320-313D1W3 UELFL320-314D1W3 UELFL320-315D1W3 UELFL320-400D1W3	440 17 5/16	360 14 11/64	59 2 21/64	40 1 9/16	94 3 11/16	44 1 47/64	270 10 5/8	137.6 5 27/64	128.6 5.063	50 1.969	—	M39 1 1/2
105	UELFL321D1W3	440	360	59	40	94	44	270	150.3	139.7	48.4	—	M39
110	UELFL322D1W3	470	390	60	42	96	44	300	152.1	141.3	49.2	—	M39

Notes (1) These numbers indicate relubricatable type. If maintenance free type is needed, please order without suffix "D1".

(2) Inner race face does not protrude from the housing face except UELFL305 and UELFL316.

Remarks Please refer to page A21 for size of grease fitting.

Bearing number	Housing number	Mass of unit kg lb
UEL317D1W3	FL317D1	16
UEL317-304D1W3	FL317D1	35
UEL317-305D1W3	FL317D1	35
UEL317-306D1W3	FL317D1	35
UEL318D1W3	FL318D1	19
UEL318-307D1W3	FL318D1	42
UEL318-308D1W3	FL318D1	42
UEL319D1W3	FL319D1	24
UEL319-310D1W3	FL319D1	53
UEL319-311D1W3	FL319D1	53
UEL319-312D1W3	FL319D1	53
UEL320D1W3	FL320D1	28
UEL320-313D1W3	FL320D1	62
UEL320-314D1W3	FL320D1	62
UEL320-315D1W3	FL320D1	62
UEL320-400D1W3	FL320D1	62
UEL321D1W3	FL321D1	30
UEL322D1W3	FL322D1	36

Rhombus flanged unit, cast housing Eccentric locking collar type

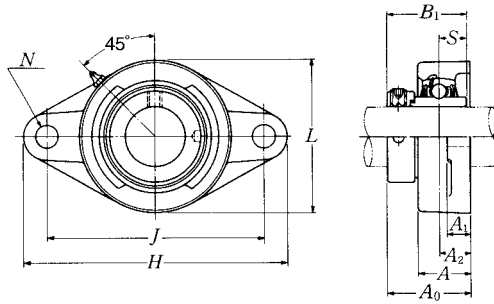

Shaft dia. mm inch	Unit number (1)	Nominal dimensions										Bolt size mm inch
		mm inch										
		H	J	A ₂	A ₁	A	N	L	A ₀	B ₁	S	
20 3/4	UELFLU204D1W3	113	90	19	15	29.5	11.5	61	45.6	43.7	17.1	M10
	UELFLU204-012D1W3	4 7/16	3 35/64	3/4	19/32	1 5/32	29/64	2 13/32	1 51/64	1.720	0.673	5/16
25 13/16 7/8 15/16	UELFLU205D1W3	125	99	19	15	30	11.5	70	45.95	44.4	17.45	M10
	UELFLU205-013D1W3	4 29/32	3 57/64	3/4	19/32	1 3/16	29/64	2 3/4	1 13/16	1.748	0.687	3/8
	UELFLU205-014D1W3											
	UELFLU205-015D1W3											
1	UELFLU205-100D1W3											
30 1 1/16 1 1/8 1 3/16 1 1/4	UELFLU206D1W3	142	116.5	20	16	33	11.5	83	50.15	48.4	18.25	M10
	UELFLU206-101D1W3	5 19/32	4 19/32	25/32	5/8	1 5/16	29/64	3 9/32	1 31/32	1.906	0.719	3/8
	UELFLU206-102D1W3											
	UELFLU206-103D1W3											
UELFLU206-104D1W3												
35 1 1/4 1 5/16 1 3/8 1 7/16	UELFLU207D1W3	156	130	21	17	36	14	96	53.3	51.1	18.8	M12
	UELFLU207-104D1W3	6 5/32	5 1/8	53/64	21/32	1 13/32	35/64	3 25/32	2 3/32	2.012	0.740	1/2
	UELFLU207-105D1W3											
	UELFLU207-106D1W3											
UELFLU207-107D1W3												
40 1 1/2 1 9/16	UELFLU208D1W3	172	143.5	24	17	39	14	105	58.9	56.3	21.4	M12
	UELFLU208-108D1W3	6 25/32	5 21/32	15/16	21/32	1 17/32	35/64	4 1/8	2 5/16	2.217	0.843	1/2
	UELFLU208-109D1W3											
45 1 5/8 1 11/16 1 3/4	UELFLU209D1W3	180	148.5	24	18	40	16	111	58.9	56.3	21.4	M14
	UELFLU209-110D1W3	7 3/32	5 27/32	15/16	23/32	1 9/16	5/8	4 3/8	2 5/16	2.217	0.843	1/2
	UELFLU209-111D1W3											
	UELFLU209-112D1W3											
UELFLU209-112D1W3												
50 1 13/16 1 7/8 1 15/16 2	UELFLU210D1W3	190	157	28	20	46	18	116	66.1	62.7	24.6	M16
	UELFLU210-113D1W3	7 15/32	6 3/16	1 7/64	25/32	1 13/16	45/64	4 9/16	2 39/64	2.469	0.969	5/8
	UELFLU210-114D1W3											
	UELFLU210-115D1W3											
UELFLU210-200D1W3												

Note (1) These numbers indicate relubricatable type. If maintenance free type is needed, please order without suffix "D1".

Remarks Please refer to page A21 for size of grease fitting.

Bearing number	Housing number	Mass of unit kg lb
UEL204D1W3	FLU204D1	0.6
UEL204-012D1W3	FLU204D1	1.3
UEL205D1W3	FLU205D1	0.7
UEL205-013D1W3	FLU205D1	1.5
UEL205-014D1W3	FLU205D1	
UEL205-015D1W3	FLU205D1	
UEL205-100D1W3	FLU205D1	
UEL206D1W3	FLU206D1	1.1
UEL206-101D1W3	FLU206D1	2.4
UEL206-102D1W3	FLU206D1	
UEL206-103D1W3	FLU206D1	
UEL206-104D1W3	FLU206D1	
UEL207D1W3	FLU207D1	1.5
UEL207-104D1W3	FLU207D1	3.3
UEL207-105D1W3	FLU207D1	
UEL207-106D1W3	FLU207D1	
UEL207-107D1W3	FLU207D1	
UEL208D1W3	FLU208D1	1.9
UEL208-108D1W3	FLU208D1	4.2
UEL208-109D1W3	FLU208D1	
UEL209D1W3	FLU209D1	2.3
UEL209-110D1W3	FLU209D1	5.1
UEL209-111D1W3	FLU209D1	
UEL209-112D1W3	FLU209D1	
UEL209-112D1W3	FLU209D1	
UEL210D1W3	FLU210D1	2.9
UEL210-113D1W3	FLU210D1	6.4
UEL210-114D1W3	FLU210D1	
UEL210-115D1W3	FLU210D1	
UEL210-200D1W3	FLU210D1	

Rhombus flanged unit, cast housing Eccentric locking collar type

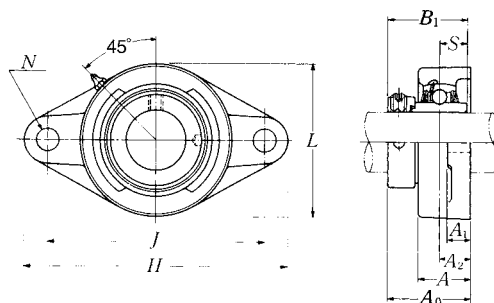

Shaft dia. mm inch	Unit number (1)	Nominal dimensions										Bolt size mm inch
		mm inch										
		H	J	A ₂	A ₁	A	N	L	A ₀	B ₁	S	
55	UELFLU211D1W3	217	184	31	21	49	18	134	74.65	71.4	27.75	M16
2	UELFLU211-200D1W3											
2 1/16	UELFLU211-201D1W3	8 17/32	7 1/4	1 7/32	1 3/16	1 15/16	45/64	5 9/32	2 15/16	2.811	1.093	5/8
2 7/8	UELFLU211-202D1W3											
2 3/16	UELFLU211-203D1W3											
60	UELFLU212D1W3	235	202	34	21	53	18	138	80.85	77.8	30.95	M16
2 1/4	UELFLU212-204D1W3											
2 5/16	UELFLU212-205D1W3	9 1/4	7 61/64	1 11/32	1 3/16	2 3/32	45/64	5 7/16	3 3/16	3.063	1.219	5/8
2 3/8	UELFLU212-206D1W3											
2 7/16	UELFLU212-207D1W3											
65	UELFLU213D1W3	248	210	38	22	59	20.5	152	89.55	85.7	34.15	M18
2 1/2	UELFLU213-208D1W3	9 3/4	8 17/64	1 1/2	7/8	2 5/16	13/16	5 31/32	3 17/32	3.374	1.344	5/8
2 9/16	UELFLU213-209D1W3											
70	UELFLU214D1W3	257	216	38	22	62	20.5	159	89.55	85.7	34.15	M18
2 5/8	UELFLU214-210D1W3											
2 1/16	UELFLU214-211D1W3	10 1/8	8 1/2	1 1/2	7/8	2 7/16	13/16	6 1/4	3 17/32	3.374	1.344	5/8
2 3/4	UELFLU214-212D1W3											
75	UELFLU215D1W3	266	225	41	22	65	20.5	165	95.7	92	37.3	M18
2 13/16	UELFLU215-213D1W3											
2 7/8	UELFLU215-214D1W3	10 15/32	8 55/64	1 39/64	7/8	2 9/16	13/16	6 1/2	3 49/64	3.622	1.469	5/8
2 9/16	UELFLU215-215D1W3											
3	UELFLU215-300D1W3											

Note (1) These numbers indicate relubricatable type. If maintenance free type is needed, please order without suffix "D1".

Remarks Please refer to page A21 for size of grease fitting.

Bearing number	Housing number	Mass of unit kg lb
UEL211D1W3	FLU211D1	3.6
UEL211-200D1W3	FLU211D1	
UEL211-201D1W3	FLU211D1	7.9
UEL211-202D1W3	FLU211D1	
UEL211-203D1W3	FLU211D1	
UEL212D1W3	FLU212D1	4.0
UEL212-204D1W3	FLU212D1	
UEL212-205D1W3	FLU212D1	8.8
UEL212-206D1W3	FLU212D1	
UEL212-207D1W3	FLU212D1	
UEL213D1W3	FLU213D1	5.6
UEL213-208D1W3	FLU213D1	12
UEL213-209D1W3	FLU213D1	
UEL214D1W3	FLU214D1	6.3
UEL214-210D1W3	FLU214D1	
UEL214-211D1W3	FLU214D1	14
UEL214-212D1W3	FLU214D1	
UEL215D1W3	FLU215D1	6.8
UEL215-213D1W3	FLU215D1	
UEL215-214D1W3	FLU215D1	15
UEL215-215D1W3	FLU215D1	
UEL215-300D1W3	FLU215D1	

Light rhombus flanged unit, cast housing Eccentric locking collar type

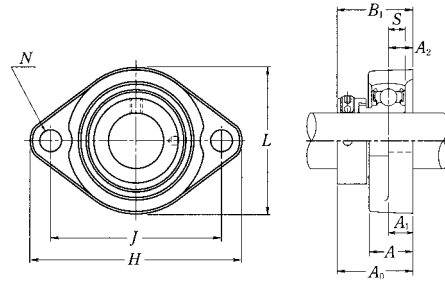

Shaft dia. mm inch	Unit number (*)	Nominal dimensions										Bolt size mm inch
		mm inch										
		H	J	A ₂	A ₁	A	N	L	A ₀	B ₁	S	
12 1/2	AELFB201W3 AELFB201-008W3	81 3 3/16	63.5 2 1/2	9.5 3/8	9.5 3/8	18 23/32	7 9/32	56 2 7/32	31.6 1 1/4	28.6 1.126	6.5 0.256	M6 1/4
15 9/16 5/8	AELFB202W3 AELFB202-009W3 AELFB202-010W3	81 3 3/16	63.5 2 1/2	9.5 3/8	9.5 3/8	18 23/32	7 9/32	56 2 7/32	31.6 1 1/4	28.6 1.126	6.5 0.256	M6 1/4
17 1 1/2	AELFB203W3 AELFB203-011W3	81 3 3/16	63.5 2 1/2	9.5 3/8	9.5 3/8	18 23/32	7 9/32	56 2 7/32	31.6 1 1/4	28.6 1.126	6.5 0.256	M6 1/4
20 3/4	AELFB204W3 AELFB204-012W3	90 3 17/32	71.5 2 13/16	11 7/16	11 7/16	20 25/32	10 25/64	61 2 13/32	34.5 1 23/64	31 1.220	7.5 0.295	M8 5/16
25 13/16 7/8 15/16 1	AELFB205W3 AELFB205-013W3 AELFB205-014W3 AELFB205-015W3 AELFB205-100W3	95 3 3/4	76 2 63/64	11 7/16	11 7/16	20 25/32	10 25/64	64 2 17/32	34.5 1 23/64	31 1.220	7.5 0.295	M8 5/16
30 1 1/16 1 1/8 1 3/16 1 1/4	AELFB206W3 AELFB206-101W3 AELFB206-102W3 AELFB206-103W3 AELFB206-104W3	113 4 7/16	90.5 3 9/16	12 15/32	12 15/32	22.5 7/8	12 15/32	76 3	38.7 1 17/32	35.7 1.406	9 5415	M10 3/8
35 1 1/4 1 5/16 1 3/8 1 1/16	AELFB207W3 AELFB207-104W3 AELFB207-105W3 AELFB207-106W3 AELFB207-107W3	122 4 13/16	100 3 15/16	11 7/16	13 1/2	24 15/16	12 15/32	89 3 1/2	40.4 1 19/32	38.9 1.531	9.5 0.374	M10 3/8

Note (*) If relubricatable type is needed, please order with suffix "D1".

Bearing number	Housing number	Mass of unit kg lb
AEL201W3	FB201	0.3
AEL201-008W3	FB201	0.7
AEL202W3	FB201	0.3
AEL202-009W3	FB201	0.7
AEL202-010W3	FB201	0.7
AEL203W3	FB201	0.3
AEL203-011W3	FB201	0.7
AEL204W3	FB204	0.4
AELB204-012W3	FB204	0.9
AEL205W3	FB205	0.4
AEL205-013W3	FB205	
AEL205-014W3	FB205	0.9
AEL205-015W3	FB205	
AEL205-100W3	FB205	
AEL206W3	FB206	0.6
AEL206-101W3	FB206	
AEL206-102W3	FB206	1.3
AEL206-103W3	FB206	
AEL206-104W3	FB206	
AEL207W3	FB207	0.9
AEL207-104W3	FB207	
AEL207-105W3	FB207	2.0
AEL207-106W3	FB207	
AEL207-107W3	FB207	

Light rhombus flanged unit, cast housing Eccentric locking collar type

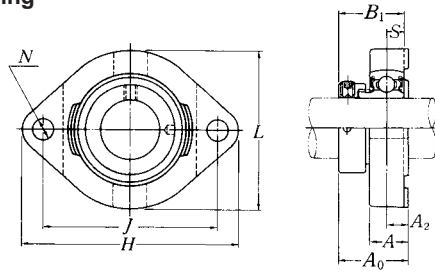

Shaft dia. mm inch	Unit number ⁽¹⁾	Nominal dimensions									Bolt size mm inch
		mm inch									
		H	J	A ₂	A	N	L	A ₀	B ₁	S	
12 1/2	AELFD201W3	81	63	8.5	15	7	59	30.6	28.6	6.5	M6
	AELFD201-008W3	3 3/16	2 31/64	21/64	19/32	9/32	2 5/16	1 13/64	1.126	0.256	1/4
15 9/16 5/8	AELFD202W3	81	63	8.5	15	7	59	30.6	28.6	6.5	M6
	AELFD202-009W3	3 3/16	2 31/64	21/64	19/32	9/32	2 5/16	1 13/64	1.126	0.256	1/4
	AELFD202-010W3										
17 11/16	AELFD203W3	81	63	8.5	15	7	59	30.6	28.6	6.5	M6
	AELFD203-011W3	3 3/16	2 31/64	21/64	19/32	9/32	2 5/16	1 13/64	1.126	0.256	1/4
20 3/4	AELFD204W3	90	71	9.5	17	10	67	33	31	7.5	M8
	AELFD204-012W3	3 17/32	2 51/64	3/8	2 1/32	25/64	2 5/8	1 13/64	1.220	0.295	5/16
25 13/16 7/8 15/16 1	AELFD205W3	95	76	9.5	17	10	71	33	31	7.5	M8
	AELFD205-013W3										
	AELFD205-014W3	3 3/4	2 63/64	3/8	2 1/32	25/64	2 25/32	1 19/64	1.220	0.295	5/16
	AELFD205-015W3										
30 1 1/16 1 1/8 1 3/16 1 1/4	AELFD206W3	113	90	12	21	12	84	38.7	35.7	9	M10
	AELFD206-101W3										
	AELFD206-102W3	4 7/16	3 35/64	15/32	13/16	15/32	3 5/16	1 17/32	1.406	0.354	3/8
	AELFD206-103W3										
35 1 1/4 1 5/16 1 3/8 1 7/16	AELFD207W3	125	100	12.5	22	12	94	41.9	38.9	9.5	M10
	AELFD207-104W3										
	AELFD207-105W3	4 29/32	3 15/16	31/64	7/8	15/32	3 11/16	1 21/32	1.531	0.374	3/8
	AELFD207-106W3										
40 1 1/2 1 9/16	AELFD208W3	148	119	14.5	25	13.5	104	47.2	43.7	11	M12
	AELFD208-108W3	5 13/16	4 11/16	37/64	31/32	17/32	4 3/32	1 27/32	1.720	0.433	7/16
	AELFD208-109W3										

Note (1) If relubricatable type is needed, please order with suffix "A-" "D1". Example: A-AELFD201D1W3

Bearing number	Housing number	Mass of unit kg lb
AEL201W3	FD201	0.3
AEL201-008W3	FD201	0.7
AEL202W3	FD201	0.3
AEL202-009W3	FD201	0.7
AEL202-010W3	FD201	
AEL203W3	FD201	0.3
AEL203-011W3	FD201	0.7
AEL204W3	FD204	0.4
AEL204-012W3	FD204	0.9
AEL205W3	FD205	0.5
AEL205-013W3	FD205	
AEL205-014W3	FD205	1.1
AEL205-015W3	FD205	
AEL205-100W3	FD205	
AEL206W3	FD206	0.8
AEL206-101W3	FD206	
AEL206-102W3	FD206	1.8
AEL206-103W3	FD206	
AEL206-104W3	FD206	
AEL207W3	FD207	1.1
AEL207-104W3	FD207	
AEL207-105W3	FD207	2.4
AEL207-106W3	FD207	
AEL207-107W3	FD207	
AEL208W3	FD208	1.5
AEL208-108W3	FD208	3.3
AEL208-109W3	FD208	

Light rhombus flanged unit, cast housing Eccentric locking collar type

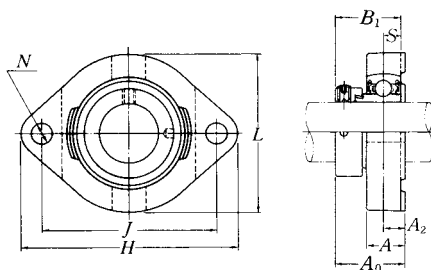

Shaft dia. mm inch	Unit number (1)	Nominal dimensions									Bolt size mm inch
		H	J	A ₂	A	N	L	A ₀	B ₁	S	
12 1/2	JELFD201W3	81	63	8.5	15	7	59	30.6	28.6	6.5	M6
	JELFD201-008W3	3 ³ / ₁₆	2 ³¹ / ₆₄	2 ¹ / ₆₄	1 ¹⁹ / ₃₂	7 ⁹ / ₃₂	2 ⁵ / ₁₆	1 ¹³ / ₆₄	1.126	0.256	1/4
15 9/16 5/8	JELFD202W3	81	63	8.5	15	7	59	30.6	28.6	6.5	M6
	JELFD202-009W3	3 ³ / ₁₆	2 ³¹ / ₆₄	2 ¹ / ₆₄	1 ¹⁹ / ₃₂	7 ⁹ / ₃₂	2 ⁵ / ₁₆	1 ¹³ / ₆₄	1.126	0.256	1/4
17 11/16	JELFD203W3	81	63	8.5	15	7	59	30.6	28.6	6.5	M6
	JELFD203-011W3	3 ³ / ₁₆	2 ³¹ / ₆₄	2 ¹ / ₆₄	1 ¹⁹ / ₃₂	7 ⁹ / ₃₂	2 ⁵ / ₁₆	1 ¹³ / ₆₄	1.126	0.256	1/4
20 3/4	JELFD204W3	90	71	9.5	17	10	67	33	31	7.5	M8
	JELFD204-012W3	3 ¹⁷ / ₃₂	2 ⁵¹ / ₆₄	3 ³ / ₈	2 ¹ / ₃₂	2 ²⁵ / ₆₄	2 ⁵ / ₈	1 ¹⁹ / ₆₄	1.220	0.295	5/16
25 13/16 7/8 15/16 1	JELFD205W3	95	76	9.5	17	10	71	33	31	7.5	M8
	JELFD205-013W3	3 ³ / ₄	2 ⁶³ / ₆₄	3 ³ / ₈	2 ¹ / ₃₂	2 ²⁵ / ₆₄	2 ²⁵ / ₃₂	1 ¹⁹ / ₆₄	1.220	0.295	5/16
	JELFD205-014W3										
	JELFD205-015W3										
JELFD205-100W3											
30 1 1/16 1 1/8 1 3/16 1 1/4	JELFD206W3	113	90	12	21	12	84	38.7	35.7	9	M10
	JELFD206-101W3	4 ⁷ / ₁₆	3 ³⁵ / ₆₄	1 ¹⁵ / ₃₂	1 ¹³ / ₁₆	1 ¹⁵ / ₃₂	3 ⁵ / ₁₆	1 ¹⁷ / ₃₂	1.406	0.354	3/8
	JELFD206-102W3										
	JELFD206-103W3										
JELFD206-104W3											
35 1 1/4 1 5/16 1 3/8 1 7/16	JELFD207W3	125	100	12.5	22	12	94	41.9	38.9	9.5	M10
	JELFD207-104W3	4 ²⁹ / ₃₂	3 ¹⁵ / ₁₆	3 ¹ / ₆₄	7/8	1 ¹⁵ / ₃₂	3 ¹¹ / ₁₆	1 ²¹ / ₃₂	1.531	0.374	3/8
	JELFD207-105W3										
	JELFD207-106W3										
JELFD207-107W3											
40 1 1/2 1 9/16	JELFD208W3	148	119	14.5	25	13.5	104	47.2	43.7	11	M12
	JELFD208-108W3	5 ¹³ / ₁₆	4 ¹¹ / ₁₆	3 ³⁷ / ₆₄	3 ¹ / ₃₂	1 ¹⁷ / ₃₂	4 ³ / ₃₂	1 ²⁷ / ₃₂	1.720	0.433	7/16
	JELFD208-109W3										

Note (1) If relubricatable type is needed, please order with suffix "A-" "D1". Example:A-JELFD201D1W3

Bearing number	Housing number	Mass of unit kg lb
JEL201W3	FD201	0.3
JEL201-008W3	FD201	0.7
JEL202W3	FD201	0.3
JEL202-009W3	FD201	0.7
JEL202-010W3	FD201	0.7
JEL203W3	FD201	0.3
JEL203-011W3	FD201	0.7
AEL204W3	FD204	0.4
JEL204-012W3	FD204	0.9
JEL205W3	FD205	0.5
JEL205-013W3	FD205	1.1
JEL205-014W3	FD205	
JEL205-015W3	FD205	
JEL205-100W3	FD205	
JEL206W3	FD206	0.8
JEL206-101W3	FD206	1.8
JEL206-102W3	FD206	
JEL206-103W3	FD206	
JEL206-104W3	FD206	
JEL207W3	FD207	1.1
JEL207-104W3	FD207	2.4
JEL207-105W3	FD207	
JEL207-106W3	FD207	
JEL207-107W3	FD207	
JEL208W3	FD208	1.5
JEL208-108W3	FD208	3.3
JEL208-109W3	FD208	

Round flanged unit, pressed steel housing Eccentric locking collar type

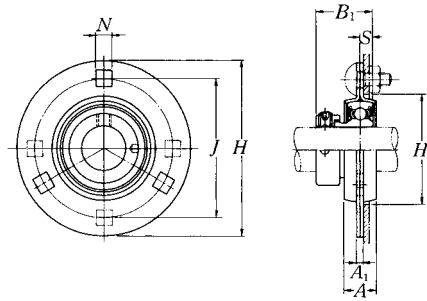

Shaft dia. mm inch	Unit number	Nominal dimensions								Bolt size mm inch
		H	J	A ₁	mm inch M ⁽¹⁾ A		B ₁	S	H ₁ min.	
12 1/2	AELPF201W3	81	63.5	4	7.1	14	28.6	6.5	49	M6
	AELPF201-008W3	3 3/16	2 1/2	0.157	9/32	9/16	1.126	0.256	1 15/16	1/4
15 9/16 5/8	AELPF202W3	81	63.5	4	7.1	14	28.6	6.5	49	M6
	AELPF202-009W3 AELPF202-010W3	3 3/16	2 1/2	0.157	9/32	9/16	1.126	0.256	1 15/16	1/4
17 11/16	AELPF203W3	81	63.5	4	7.1	14	28.6	6.5	49	M6
	AELPF203-011W3	3 3/16	2 1/2	0.157	9/32	9/16	1.126	0.256	1 15/16	1/4
20 3/4	AELPF204W3	90	71.5	4	9	16	31	7.5	56	M8
	AELPF204-012W3	3 35/64	2 13/16	0.157	23/64	5/8	1.220	0.295	2 7/32	5/16
25 13/16 7/8 15/16 1	AELPF205W3	95	76	4	9	18	31	7.5	60	M8
	AELPF205-013W3	3 3/4	2 63/64	0.157	23/64	23/32	1.220	0.295	2 3/8	5/16
	AELPF205-014W3									
	AELPF205-015W3									
AELPF205-100W3										
30 1 1/16 1 1/8 1 3/16 1 1/4	AELPF206W3	113	90.5	5.2	11	18	35.7	9	71	M10
	AELPF206-101W3	4 7/16	3 9/16	0.205	7/16	23/32	1.406	0.354	2 19/16	3/8
	AELPF206-102W3									
	AELPF206-103W3									
AELPF206-104W3										
35 1 1/4 1 5/16 1 3/8 1 7/16	AELPF207W3	122	100	5.2	11	20	38.9	9.5	81	M10
	AELPF207-104W3	4 13/16	3 15/16	0.205	7/16	25/32	1.531	0.374	3 3/16	3/8
	AELPF207-105W3									
	AELPF207-106W3									
AELPF207-107W3										
40 1 1/2 1 9/16	AELPF208W3	148	119	6.8	13.5	21	43.7	11	91	M12
	AELPF208-108W3 AELPF208-109W3	5 13/16	4 11/16	0.268	17/32	13/16	1.720	0.433	3 19/32	1/2

Notes (1) AELPF208 has four bolt holes.

(2) The permissible load only applies in applications where the load is stable and the speed is 2400 min⁻¹ or less.

Max. load ⁽²⁾ recommended		Bearing number	Housing number	Mass of unit kg lb
N lbf				
radial	axial			
2 700 600	1 350 300	AEL201W3	PF203	0.3
		AEL201-008W3	PF203	0.7
2 700 600	1 350 300	AEL202W3	PF203	0.3
		AEL202-009W3 AEL202-010W3	PF203	0.7
2 700 600	1 350 300	AEL203W3	PF203	0.3
		AEL203-011W3	PF203	0.7
3 000 660	1 500 330	AEL204W3	PF204	0.3
		AEL204-012W3	PF204	0.7
4 000 880	2 000 440	AEL205W3	PF205	0.4
		AEL205-013W3	PF205	0.9
		AEL205-014W3	PF205	
		AEL205-015W3 AEL205-100W3	PF205	
5 000 1 100	2 500 550	AEL206W3	PF206	0.6
		AEL206-101W3	PF206	1.3
		AEL206-102W3	PF206	
		AEL206-103W3 AEL206-104W3	PF206	
6 000 1 300	3 000 650	AEL207W3	PF207	0.8
		AEL207-104W3	PF207	1.8
		AEL207-105W3	PF207	
		AEL207-106W3 AEL207-107W3	PF207	
7 000 1 500	3 500 750	AEL208W3	PF208	1.4
		AEL208-108W3 AEL208-109W3	PF208	3.1

Round flanged unit, pressed steel housing Eccentric locking collar type

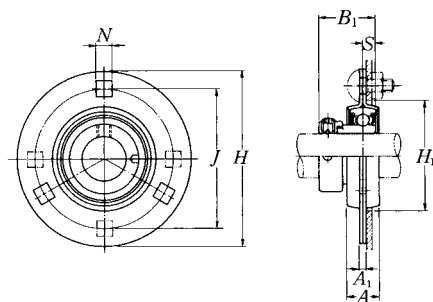

Shaft dia. mm inch	Unit number	Nominal dimensions								Bolt size mm inch
		H	J	A ₁	mm inch N ⁽¹⁾ A		B ₁	S	H ₁ min.	
12 1/2	JELPF201W3	81	63.5	4	7.1	14	28.6	6.5	49	M6
	JELPF201-008W3	3 3/16	2 1/2	0.157	9/32	9/16	1.126	0.256	1 15/16	1/4
15 9/16 5/8	JELPF202W3	81	63.5	4	7.1	14	28.6	6.5	49	M6
	JELPF202-009W3 JELPF202-010W3	3 3/16	2 1/2	0.157	9/32	9/16	1.126	0.256	1 15/16	1/4
17 11/16	JELPF203W3	81	63.5	4	7.1	14	28.6	6.5	49	M6
	JELPF203-011W3	3 3/16	2 1/2	0.157	9/32	9/16	1.126	0.256	1 15/16	1/4
20 3/4	JELPF204W3	90	71.5	4	9	16	31	7.5	56	M8
	JELPF204-012W3	3 35/64	2 13/16	0.157	23/64	5/8	1.220	0.295	2 7/32	5/16
25 13/16 7/8 15/16 1	JELPF205W3	95	76	4	9	18	31	7.5	60	M8
	JELPF205-013W3	3 3/4	2 63/64	0.157	23/64	23/32	1.220	0.295	2 3/8	5/16
	JELPF205-014W3									
	JELPF205-015W3									
JELPF205-100W3										
30 1 1/16 1 1/8 1 3/16 1 1/4	JELPF206W3	113	90.5	5.2	11	18	35.7	9	71	M10
	JELPF206-101W3	4 7/16	3 9/16	0.205	7/16	23/32	1.406	0.354	2 19/16	3/8
	JELPF206-102W3									
	JELPF206-103W3									
JELPF206-104W3										
35 1 1/4 1 5/16 1 3/8 1 7/16	JELPF207W3	122	100	5.2	11	20	38.9	9.5	81	M10
	JELPF207-104W3	4 13/16	3 15/16	0.205	7/16	25/32	1.531	0.374	3 3/16	3/8
	JELPF207-105W3									
	JELPF207-106W3									
JELPF207-107W3										
40 1 1/2 1 9/16	JELPF208W3	148	119	6.8	13.5	21	43.7	11.0	91	M12
	JELPF208-108W3 JELPF208-109W3	5 13/16	4 11/16	0.268	17/32	13/16	1.720	0.433	3 19/32	1/2

Notes (1) JELPF208 has four bolt holes.

(2) The permissible load only applies in applications where the load is stable and the speed is 2400 min⁻¹ or less.

Max. load ⁽²⁾ recommended		Bearing number	Housing number	Mass of unit kg lb
N lbf				
radial	axial			
2 700 600	1 350 300	JEL201W3	PF203	0.3
		JEL201-008W3	PF203	0.7
2 700 600	1 350 300	JEL202W3	PF203	0.3
		JEL202-009W3 JEL202-010W3	PF203	0.7
2 700 600	1 350 300	JEL203W3	PF203	0.3
		JEL203-011W3	PF203	0.7
3 000 660	1 500 330	JEL204W3	PF204	0.3
		JEL204-012W3	PF204	0.7
4 000 880	2 000 440	JEL205W3	PF205	0.4
		JEL205-013W3	PF205	0.9
		JEL205-014W3	PF205	
		JEL205-015W3 JEL205-100W3	PF205	
5 000 1 100	2 500 550	JEL206W3	PF206	
		JEL206-101W3	PF206	1.3
		JEL206-102W3	PF206	
		JEL206-103W3 JEL206-104W3	PF206	
6 000 1 300	3 000 650	JEL207W3	PF207	
		JEL207-104W3	PF207	1.8
		JEL207-105W3	PF207	
		JEL207-106W3 JEL207-107W3	PF207	
7 000 1 500	3 500 750	JEL208W3	PF208	
		JEL208-108W3 JEL208-109W3	PF208	3.1

AELRPF2

Round flanged unit, pressed steel housing with rubber ring
Eccentric locking collar type

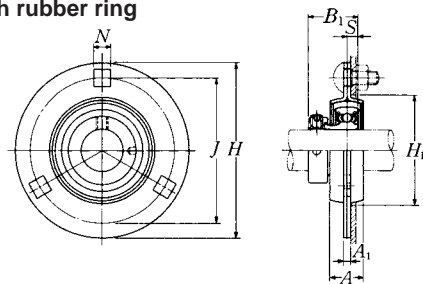

Shaft dia. mm inch	Unit number	Nominal dimensions									Bolt size mm inch
		H	J	A ₁	mm inch		N	A	B ₁	S	
12 1/2	AELRPF201W3	90	71.5	4	9	16	28.6	6.5	56	M8	
	AELRPF201-008W3	3 ³⁵ / ₆₄	2 ¹³ / ₁₆	0.157	23 ³⁵ / ₆₄	5 ⁸ / ₈	1.126	0.256	2 ⁷ / ₃₂	5 ¹⁶ / ₁₆	
15 9/16 5/8	AELRPF202W3	90	71.5	4	9	16	28.6	6.5	56	M8	
	AELRPF202-009W3 AELRPF202-010W3	3 ³⁵ / ₆₄	2 ¹³ / ₁₆	0.157	23 ³⁵ / ₆₄	5 ⁸ / ₈	1.126	0.256	2 ⁷ / ₃₂	5 ¹⁶ / ₁₆	
17 11/16	AELRPF203W3	90	71.5	4	9	16	28.6	6.5	56	M8	
	AELRPF203-011W3	3 ³⁵ / ₆₄	2 ¹³ / ₁₆	0.157	23 ³⁵ / ₆₄	5 ⁸ / ₈	1.126	0.256	2 ⁷ / ₃₂	5 ¹⁶ / ₁₆	
20 3/4	AELRPF204W3	95	76	4	9	18	31	7.5	60	M8	
	AELRPF204-012W3	3 ³ / ₄	2 ⁶³ / ₆₄	0.157	23 ³⁵ / ₆₄	23 ³² / ₃₂	1.220	0.295	2 ³ / ₈	5 ¹⁶ / ₁₆	
25 13/16 7/8 15/16 1	AELRPF205W3	113	90.5	5.2	11	18	31	7.5	71	M10	
	AELRPF205-013W3	4 ⁷ / ₁₆	3 ⁹ / ₁₆	0.205	7 ⁷ / ₁₆	23 ³² / ₃₂	1.220	0.295	2 ¹³ / ₁₆	3 ⁸ / ₈	
	AELRPF205-014W3										
	AELRPF205-015W3										
AELRPF205-100W3											
30 1 1/16 1 1/8 1 3/16 1 1/4	AELRPF206W3	122	100	5.2	11	20	35.7	9	81	M10	
	AELRPF206-101W3	4 ¹³ / ₁₆	3 ¹⁵ / ₁₆	0.205	7 ⁷ / ₁₆	25 ³² / ₃₂	1.406	0.354	3 ³ / ₁₆	3 ⁸ / ₈	
	AELRPF206-102W3										
	AELRPF206-103W3										
AELRPF206-104W3											

Note (1) The permissible load only applies in applications where the load is stable and the speed is 2400 min⁻¹ or less.
Remarks When an anti-vibration rubber ring is used, the self alignment capability will be reduce.

Max. load (1) recommended		Bearing number	Housing number		Mass of unit kg lb
N lbf			rubber ring	steel	
radial	axial				
1 000 220	200 40	AEL201W3	R201	PF204	0.3
		AEL201-008W3	R201	PF204	0.7
1 000 220	200 40	AEL202W3	R201	PF204	0.3
		AEL202-009W3 AEL202-010W3	R201	PF204	0.7
1 000 220	200 40	AEL203W3	R201	PF204	0.3
		AEL203-011W3	R201	PF204	0.7
1 150 250	200 40	AEL204W3	R204	PF205	0.4
		AEL204-012W3	R204	PF205	0.9
1 300 280	200 40	AEL205W3	R205	PF206	0.5
		AEL205-013W3	R205	PF206	1.1
		AEL205-014W3	R205	PF206	
		AEL205-015W3 AEL205-100W3	R205	PF206	
1 500 330	200 40	AEL206W3	R206	PF207	
		AEL206-101W3	R206	PF207	1.5
		AEL206-102W3	R206	PF207	
		AEL206-103W3 AEL206-104W3	R206	PF207	

Rhombus flanged unit, pressed steel housing Eccentric locking collar type

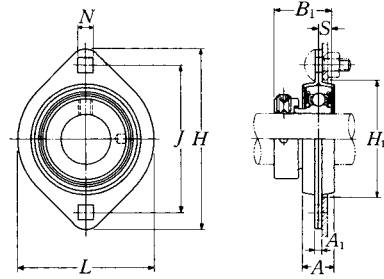

Shaft dia. mm inch	Unit number	Nominal dimensions									Bolt size mm inch
		mm inch									
		H	J	A ₁	N	A	L	B ₁	S	H ₁	
12 1/2	AELPFL201W3 AELPFL201-008W3	81 3 3/16	63.5 2 1/2	4 0.157	7.1 9/32	14 9/16	59 2 5/16	28.6 1.126	6.5 0.256	49 1 15/16	M6 1/4
15 9/16 5/8	AELPFL202W3 AELPFL202-009W3 AELPFL202-010W3	81 3 3/16	63.5 2 1/2	4 0.157	7.1 9/32	14 9/16	59 2 5/16	28.6 1.126	6.5 0.256	49 1 15/16	M6 1/4
17 11/16	AELPFL203W3 AELPFL203-011W3	81 3 3/16	63.5 2 1/2	4 0.157	7.1 9/32	14 9/16	59 2 5/16	28.6 1.126	6.5 0.256	49 1 15/16	M6 1/4
20 3/4	AELPFL204W3 AELPFL204-012W3	90 3 5/8	71.5 2 13/16	4 0.157	9 23/64	16 5/8	67 2 5/8	31 1.220	7.5 0.295	56 2 7/32	M8 5/16
25 13/16 7/8 15/16 1	AELPFL205W3 AELPFL205-013W3 AELPFL205-014W3 AELPFL205-015W3 AELPFL205-100W3	95 3 3/4	76 2 63/64	4 0.157	9 23/64	18 23/32	71 2 25/32	31 1.220	7.5 0.295	60 2 3/8	M8 5/16
30 1 1/16 1 1/8 1 3/16 1 1/4	AELPFL206W3 AELPFL206-101W3 AELPFL206-102W3 AELPFL206-103W3 AELPFL206-104W3	113 4 7/16	90.5 3 9/16	5.2 0.205	11 7/16	18 23/32	84 3 5/16	35.7 1.406	9 0.354	71 2 13/16	M10 3/8
35 1 1/4 1 5/16 1 3/8 1 7/16	AELPFL207W3 AELPFL207-104W3 AELPFL207-105W3 AELPFL207-106W3 AELPFL207-107W3	122 4 13/16	100 3 15/16	5.2 0.205	11 7/16	20 25/32	94 3 11/16	38.9 1.531	9.5 0.374	81 3 3/16	M10 3/8
40 1 1/2 1 9/16	AELPFL208W3 AELPFL208-108W3 AELPFL208-109W3	148 5 13/16	119 4 11/16	6.8 0.268	13.5 17/32	21 13/16	100 3 15/16	43.7 1.720	11 0.433	91 3 19/32	M12 1/2

Note (!) The permissible load only applies in applications where the load is stable and the speed is 2400 min⁻¹ or less.

Max. load (!)		Bearing number	Housing number	Mass of unit
N lbf				
radial	axial			kg lb
2 700	1 350	AEL201W3	PFL203W3	0.3
600	300	AEL201-008W3	PFL203W3	0.7
2 700	1 350	AEL202W3	PFL203W3	0.3
600	300	AEL202-009W3 AEL202-010W3	PFL203W3 PFL203W3	0.7
2 700	1 350	AEL203W3	PFL203W3	0.3
600	300	AEL203-011W3	PFL203W3	0.7
3 000	1 500	AEL204W3	PFL204W3	0.3
660	330	AEL204-012W3	PFL204W3	0.7
4 000	2 000	AEL205W3	PFL205W3	0.4
880	440	AEL205-013W3 AEL205-014W3 AEL205-015W3 AEL205-100W3	PFL205W3 PFL205W3 PFL205W3 PFL205W3	0.9
5 000	2 500	AEL206W3	PFL206W3	0.6
1 100	550	AEL206-101W3 AEL206-102W3 AEL206-103W3 AEL206-104W3	PFL206W3 PFL206W3 PFL206W3 PFL206W3	1.3
6 000	3 000	AEL207W3	PFL207W3	0.9
1 300	650	AEL207-104W3 AEL207-105W3 AEL207-106W3 AEL207-107W3	PFL207W3 PFL207W3 PFL207W3 PFL207W3	2.0
6 000	3 000	AEL208W3	PFL208W3	1.3
1 300	650	AEL208-108W3 AEL208-109W3	PFL208W3 PFL208W3	2.9

Rhombus flanged unit, pressed steel housing Eccentric locking collar type

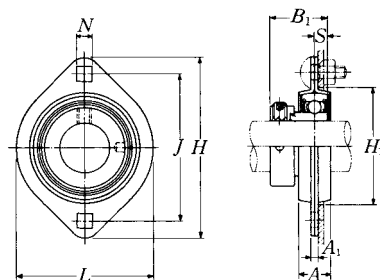

Shaft dia. mm inch	Unit number	Nominal dimensions									Bolt size mm inch
		mm inch									
		H	J	A ₁	N	A	L	B ₁	S	H ₁	
12 1/2	JELPFL201W3	81	63	4	7.1	14	59	28.6	6.5	49	M6
	JELPFL201-008W3	3 3/16	2 31/64	0.157	9/32	9/16	2 5/16	1.126	0.256	1 15/16	1/4
15 9/16 5/8	JELPFL202W3	81	63	4	7.1	14	59	28.6	6.5	49	M6
	JELPFL202-009W3 JELPFL202-010W3	3 3/16	2 31/64	0.157	9/32	9/16	2 5/16	1.126	0.256	1 15/16	1/4
17 11/16	JELPFL203W3	81	63	4	7.1	14	59	28.6	6.5	49	M6
	JELPFL203-011W3	3 3/16	2 31/64	0.157	9/32	9/16	2 5/16	1.126	0.256	1 15/16	1/4
20 3/4	JELPFL204W3	90	71	4	9	16	67	31	7.5	56	M8
	JELPFL204-012W3	3 35/64	2 51/64	0.157	23/64	5/8	2 5/8	1.220	0.295	2 7/32	5/16
25 13/16 7/8 15/16 1	JELPFL205W3	95	76	4	9	18	71	31	7.5	60	M8
	JELPFL205-013W3										
	JELPFL205-014W3	3 3/4	2 63/64	0.157	23/64	23/32	2 25/32	1.220	0.295	2 3/8	5/16
	JELPFL205-015W3 JELPFL205-100W3										
30 1 1/16 1 1/8 1 3/16 1 1/4	JELPFL206W3	113	90	5.2	11	18	84	35.7	9	71	M10
	JELPFL206-101W3										
	JELPFL206-102W3	4 7/16	3 35/64	0.205	7/16	23/32	3 5/16	1.406	0.354	2 13/16	3/8
	JELPFL206-103W3 JELPFL206-104W3										
35 1 1/4 1 5/16 1 3/8 1 7/16	JELPFL207W3	122	100	5.2	11	20	94	38.9	9.5	81	M10
	JELPFL207-104W3										
	JELPFL207-105W3	4 13/16	3 15/16	0.205	7/16	25/32	3 11/16	1.531	0.374	3 3/16	3/8
	JELPFL207-106W3 JELPFL207-107W3										
40 1 1/2 1 9/16	JELPFL208W3	148	119	6.8	13.5	21	100	43.7	11	91	M12
	JELPFL208-108W3 JELPFL208-109W3	5 13/16	4 11/16	0.268	17/32	13/16	3 15/16	1.720	0.433	3 19/32	1/2

Note (!) The permissible load only applies in applications where the load is stable and the speed is 2400 min⁻¹ or less.

Max. load (!) recommended		Bearing number	Housing number	Mass of unit kg lb
N lbf				
radial	axial			
2 700 600	1 350 300	JEL201W3	PFL203W3	0.3
		JEL201-008W3	PFL203W3	0.7
2 700 600	1 350 300	JEL202W3	PFL203W3	0.3
		JEL202-009W3 JEL202-010W3	PFL203W3 PFL203W3	0.7
2 700 600	1 350 300	JEL203W3	PFL203W3	0.3
		JEL203-011W3	PFL203W3	0.7
3 000 660	1 500 330	JEL204W3	PFL204W3	0.3
		JEL204-012W3	PFL204W3	0.7
4 000 880	2 000 440	JEL205W3	PFL205W3	0.4
		JEL205-013W3	PFL205W3	
		JEL205-014W3	PFL205W3	0.9
		JEL205-015W3 JEL205-100W3	PFL205W3 PFL205W3	
5 000 1 100	2 500 550	JEL206W3	PFL206W3	0.6
		JEL206-101W3	PFL206W3	
		JEL206-102W3	PFL206W3	1.3
		JEL206-103W3 JEL206-104W3	PFL206W3 PFL206W3	
6 000 1 300	3 000 650	JEL207W3	PFL207W3	0.9
		JEL207-104W3	PFL207W3	
		JEL207-105W3	PFL207W3	2.0
		JEL207-106W3 JEL207-107W3	PFL207W3 PFL207W3	
6 000 1 300	3 000 650	JEL208W3	PFL208W3	1.3
		JEL208-108W3 JEL208-109W3	PFL208W3 PFL208W3	2.9

Take-up unit, cast housing Eccentric locking collar type

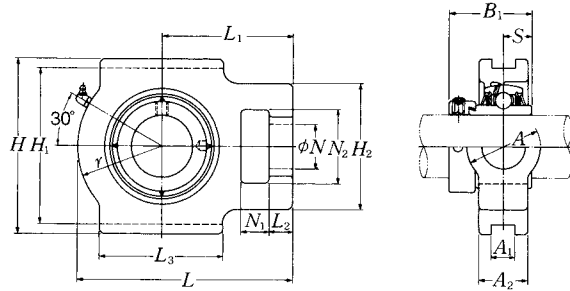

Shaft dia. mm inch	Unit number (1)	Nominal dimensions											
		mm inch											
		N_1	L_2	H_2	N_2	N	L_3	A_1	H_1	H	L	A_2	A
20 3/4	UELT204D1W3	16	12	51	32	19	51	12	76	89	94	21	32
	UELT204-012D1W3	5/8	15/32	2	1 1/4	3/4	2	0.472	2 63/64	3 1/2	3 11/16	13/16	1 1/4
25 13/16 7/8 15/16 1	UELT205D1W3	16	12	51	32	19	51	12	76	89	97	24	32
	UELT205-013D1W3												
	UELT205-014D1W3												
	UELT205-015D1W3	5/8	15/32	2	1 1/4	3/4	2	0.472	2 63/64	3 1/2	3 13/16	15/16	1 1/4
	UELT205-100D1W3												
30 1 1/16 1 1/8 1 3/16 1 1/4	UELT206D1W3	16	12	56	37	22	57	12	89	102	113	28	37
	UELT206-101D1W3												
	UELT206-102D1W3												
	UELT206-103D1W3	5/8	15/32	2 7/32	1 15/32	7/8	2 1/4	0.472	3 1/2	4 1/32	4 7/16	1 3/32	1 15/32
	UELT206-104D1W3												
35 1 1/4 1 5/16 1 3/8 1 7/16	UELT207D1W3	16	15	64	37	22	64	12	89	102	129	30	37
	UELT207-104D1W3												
	UELT207-105D1W3												
	UELT207-106D1W3	5/8	19/32	2 17/32	1 15/32	7/8	2 17/32	0.472	3 1/2	4 1/32	5 3/32	1 3/16	1 15/32
	UELT207-107D1W3												
40 1 1/2 1 9/16	UELT208D1W3	19	18	83	49	29	83	16	102	114	144	33	49
	UELT208-108D1W3												
	UELT208-109D1W3	3/4	23/32	3 9/32	1 15/16	1 5/32	3 9/32	0.630	4 1/64	4 1/2	5 21/32	1 5/16	1 15/16
45 1 5/8 1 11/16 1 3/4	UELT209D1W3	19	18	83	49	29	83	16	102	117	145	35	49
	UELT209-110D1W3												
	UELT209-111D1W3												
	UELT209-112D1W3	3/4	23/32	3 9/32	1 15/16	1 5/32	3 9/32	0.630	4 1/64	4 19/32	5 23/32	1 3/8	1 15/16
50 1 13/16 1 7/8 1 15/16 2	UELT210D1W3	19	18	83	49	29	86	16	102	117	151	37	49
	UELT210-113D1W3												
	UELT210-114D1W3												
	UELT210-115D1W3	3/4	23/32	3 9/32	1 15/16	1 5/32	3 3/8	0.630	4 1/64	4 19/32	5 15/16	1 15/32	1 15/16
	UELT210-200D1W3												

Note (1) These numbers indicate relubricatable type. If maintenance free type is needed, please order without suffix "D1".

Remarks Please refer to page A21 for size of grease fitting.

Nominal dimensions				Bearing number	Housing number	Mass of unit kg lb
mm inch						
r	L_1	B_1	S			
33	61	43.7	17.1	UELT204D1W3	T204D1	0.6
1 5/16	2 13/32	1.720	0.673	UELT204-012D1W3	T204D1	1.3
35	62	44.4	17.5	UELT205D1W3	T205D1	0.9
				UELT205-013D1W3	T205D1	
				UELT205-014D1W3	T205D1	
				UELT205-015D1W3	T205D1	2.0
				UELT205-100D1W3	T205D1	
1 3/8	2 7/16	1.748	0.687			
43	70	48.4	18.25	UELT206D1W3	T206D1	1.4
				UELT206-101D1W3	T206D1	
				UELT206-102D1W3	T206D1	
				UELT206-103D1W3	T206D1	3.1
				UELT206-104D1W3	T206D1	
1 11/16	2 3/4	1.906	0.719			
51	78	51.1	18.8	UELT207D1W3	T207D1	1.7
				UELT207-104D1W3	T207D1	
				UELT207-105D1W3	T207D1	
				UELT207-106D1W3	T207D1	3.7
				UELT207-107D1W3	T207D1	
2	3 1/16	2.012	0.740			
56	88	56.3	21.4	UELT208D1W3	T208D1	2.5
				UELT208-108D1W3	T208D1	
				UELT208-109D1W3	T208D1	5.5
2 7/32	3 15/32	2.217	0.843			
57	88	56.3	21.4	UELT209D1W3	T209D1	2.5
				UELT209-110D1W3	T209D1	
				UELT209-111D1W3	T209D1	5.5
				UELT209-112D1W3	T209D1	
2 1/4	3 15/32	2.217	0.843			
59	92	62.7	24.6	UELT210D1W3	T210D1	2.7
				UELT210-113D1W3	T210D1	
				UELT210-114D1W3	T210D1	
				UELT210-115D1W3	T210D1	6.0
				UELT210-200D1W3	T210D1	
2 5/16	3 5/8	2.469	0.969			

Take-up unit, cast housing Eccentric locking collar type

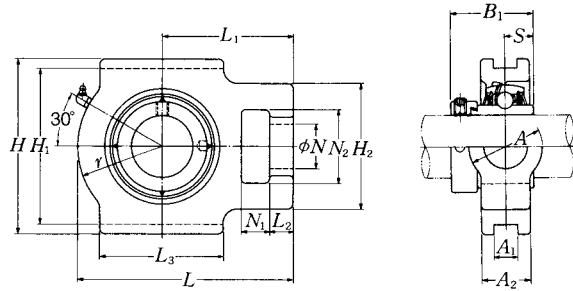

Shaft dia. mm inch	Unit number (1)	Nominal dimensions											
		mm inch											
		N_1	L_2	H_2	N_2	N	L_3	A_1	H_1	H	L	A_2	A
55 2 2 1/16 2 1/8 2 3/16	UEL211D1W3 UEL211-200D1W3 UEL211-201D1W3 UEL211-202D1W3 UEL211-203D1W3	25	21	102	64	35	95	22	130	146	171	38	64
		31/32	13/16	4 1/32	2 17/32	1 3/8	3 3/4	0.866	5 1/8	5 3/4	6 23/32	1 1/2	2 17/32
60 2 1/4 2 5/16 2 3/8 2 7/16	UEL212D1W3 UEL212-204D1W3 UEL212-205D1W3 UEL212-206D1W3 UEL212-207D1W3	32	21	102	64	35	102	22	130	146	194	42	64
		1 1/4	13/16	4 1/32	2 17/32	1 3/8	4 1/32	0.866	5 1/8	5 3/4	7 5/8	1 21/32	2 17/32
65 2 1/2 2 9/16	UEL213D1W3 UEL213-208D1W3 UEL213-209D1W3	32	23	111	70	41	121	26	151	167	224	44	70
		1 1/4	29/32	4 3/8	2 3/4	1 5/8	4 3/4	1.024	5 15/16	6 9/16	8 13/16	1 23/32	2 3/4
70 2 5/8 2 11/16 2 3/4	UEL214D1W3 UEL214-210D1W3 UEL214-211D1W3 UEL214-212D1W3	32	23	111	70	41	121	26	151	167	224	46	70
		1 1/4	29/32	4 3/8	2 3/4	1 5/8	4 3/4	1.024	5 15/16	6 9/16	8 13/16	1 13/16	2 3/4
75 2 13/16 2 7/8 2 15/16 3	UEL215D1W3 UEL215-213D1W3 UEL215-214D1W3 UEL215-215D1W3 UEL215-300D1W3	32	23	111	70	41	121	26	151	167	232	48	70
		1 1/4	29/32	4 3/8	2 3/4	1 5/8	4 3/4	1.024	5 15/16	6 9/16	9 1/8	1 7/8	2 3/4

Note (1) These numbers indicate relubricatable type. If maintenance free type is needed, please order without suffix "D1".
Remarks Please refer to page A21 for size of grease fitting.

Nominal dimensions				Bearing number	Housing number	Mass of unit kg lb
mm inch						
r	L_1	B_1	S			
65	106	71.4	27.75	UEL211D1W3 UEL211-200D1W3 UEL211-201D1W3 UEL211-202D1W3 UEL211-203D1W3	T211D1 T211D1 T211D1 T211D1 T211D1	4.2 9.3
2 9/16	4 3/16	2.811	1.093			
75	119	77.8	30.95	UEL212D1W3 UEL212-204D1W3 UEL212-205D1W3 UEL212-206D1W3 UEL212-207D1W3	T212D1 T212D1 T212D1 T212D1 T212D1	5.2 11
2 15/16	4 11/16	3.063	1.219			
87	137	85.7	34.15	UEL213D1W3 UEL213-208D1W3 UEL213-209D1W3	T213D1 T213D1 T213D1	7.7 17
3 7/16	5 13/32	3.374	1.344			
87	137	85.7	34.15	UEL214D1W3 UEL214-210D1W3 UEL214-211D1W3 UEL214-212D1W3	T214D1 T214D1 T214D1 T214D1	7.3 16
3 7/16	5 13/32	3.374	1.344			
92	140	92	37.3	UEL215D1W3 UEL215-213D1W3 UEL215-214D1W3 UEL215-215D1W3 UEL215-300D1W3	T215D1 T215D1 T215D1 T215D1 T215D1	7.8 17
3 5/8	5 1/2	3.622	1.469			

Take-up unit, cast housing Eccentric locking collar type

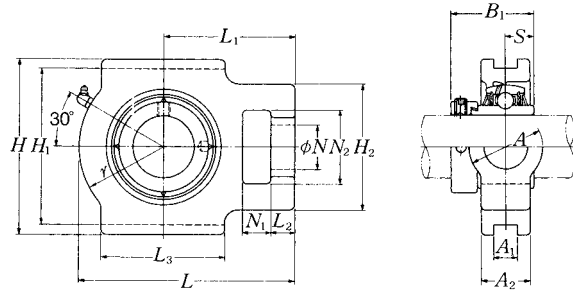

Shaft dia. mm inch	Unit number (1)	Nominal dimensions											
		mm inch											
		N_1	L_2	H_2	N_2	N	L_3	A_1	H_1	H	L	A_2	A
25 13/16 7/8 15/16 1	UELT305D1W3 UELT305-013D1W3 UELT305-014D1W3 UELT305-015D1W3 UELT305-100D1W3	16	14	62	36	26	65	12	80	89	122	26	36
		5/8	9/16	2 7/16	1 13/32	1 1/32	2 9/16	0.472	3 5/32	3 1/2	4 13/16	1 1/32	1 13/32
30 1 1/16 1 1/8 1 3/16	UELT306D1W3 UELT306-101D1W3 UELT306-102D1W3 UELT306-103D1W3	18	16	70	41	28	74	16	90	100	137	28	41
		23/32	5/8	2 3/4	1 5/8	1 3/32	2 29/32	0.630	3 5/64	3 15/16	5 13/32	1 3/32	1 5/8
35 1 1/4 1 5/16 1 3/8 1 7/16	UELT307D1W3 UELT307-104D1W3 UELT307-105D1W3 UELT307-106D1W3 UELT307-107D1W3	20	17	75	45	30	80	16	100	111	150	32	45
		25/32	21/32	2 15/16	1 25/32	1 3/16	3 5/32	0.630	3 15/16	4 3/8	5 29/32	1 1/4	1 25/32
40 1 1/2 1 9/16	UELT308D1W3 UELT308-108D1W3 UELT308-109D1W3	22	19	83	50	32	89	18	112	124	162	34	50
		7/8	3/4	3 9/32	1 31/32	1 1/4	3 1/2	0.709	4 13/32	4 7/8	6 3/6	1 11/32	1 31/32
45 1 5/8 1 11/16 1 3/4	UELT309D1W3 UELT309-110D1W3 UELT309-111D1W3 UELT309-112D1W3	24	20	90	55	34	97	18	125	138	178	38	55
		15/16	25/32	3 17/32	2 5/32	1 11/32	3 13/16	0.709	4 59/64	5 7/16	7	1 1/2	2 5/32
50 1 13/16 1 7/8 1 15/16	UELT310D1W3 UELT310-113D1W3 UELT310-114D1W3 UELT310-115D1W3	27	22	98	61	37	106	20	140	151	192	40	61
		1 1/16	7/8	3 27/32	2 13/32	1 15/32	4 3/16	0.787	5 33/64	5 15/16	7 9/16	1 9/16	2 13/32

Note (1) These numbers indicate relubricatable type. If maintenance free type is needed, please order without suffix "D1".

Remarks Please refer to page A21 for size of grease fitting.

Nominal dimensions				Bearing number	Housing number	Mass of unit kg lb
mm inch						
r	L_1	B_1	S			
46	76	46.8	16.7	UELT305D1W3 UELT305-013D1W3 UELT305-014D1W3 UELT305-015D1W3 UELT305-100D1W3	T305D1 T305D1 T305D1 T305D1	1.4 3.1
1 13/16	3	1.843	0.657			
52	85	50	17.5	UELT306D1W3 UELT306-101D1W3 UELT306-102D1W3 UELT306-103D1W3	T306D1 T306D1 T306D1	1.9 4.2
2 1/16	3 11/32	1.969	0.689			
56	94	51.6	18.3	UELT307D1W3 UELT307-104D1W3 UELT307-105D1W3 UELT307-106D1W3 UELT307-107D1W3	T307D1 T307D1 T307D1 T307D1	2.4 5.3
2 7/32	3 11/16	2.031	0.720			
62	100	57.1	19.8	UELT308D1W3 UELT308-108D1W3 UELT308-109D1W3	T308D1 T308D1 T308D1	3.1 6.8
2 7/16	3 15/16	2.248	0.780			
68	110	58.7	19.8	UELT309D1W3 UELT309-110D1W3 UELT309-111D1W3 UELT309-112D1W3	T309D1 T309D1 T309D1	4.1 9.0
2 11/16	4 11/32	2.311	0.780			
74	118	66.6	24.6	UELT310D1W3 UELT310-113D1W3 UELT310-114D1W3 UELT310-115D1W3	T310D1 T310D1 T310D1	5.2 11
2 29/32	4 21/32	2.622	0.969			

Take-up unit, cast housing Eccentric locking collar type

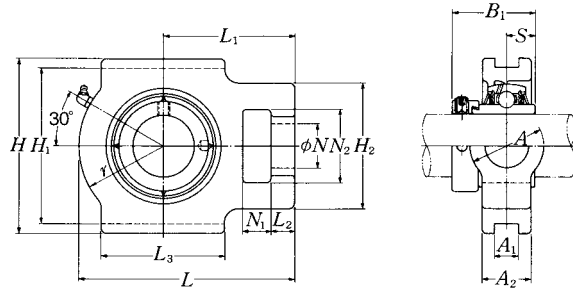

Shaft dia. mm inch	Unit number (1)	Nominal dimensions											
		mm inch											
		N_1	L_2	H_2	N_2	N	L_3	A_1	H_1	H	L	A_2	A
55 2 2 1/16 2 1/8 2 3/16	UEL311D1W3 UEL311-200D1W3 UEL311-201D1W3 UEL311-202D1W3 UEL311-203D1W3	29	23	105	66	39	115	22	150	163	207	44	66
		1 5/32	29/32	4 1/8	2 19/32	1 17/32	4 17/32	0.866	5 29/32	6 13/32	8 5/32	1 23/32	2 19/32
60 2 1/4 2 5/16 2 3/8 2 7/16	UEL312D1W3 UEL312-204D1W3 UEL312-205D1W3 UEL312-206D1W3 UEL312-207D1W3	31	25	113	71	41	123	22	160	178	220	46	71
		1 7/32	3 1/32	4 7/16	2 25/32	1 5/8	4 27/32	0.866	6 19/64	7	8 21/32	1 13/16	2 25/32
65 2 1/2 2 9/16	UEL313D1W3 UEL313-208D1W3 UEL313-209D1W3	32	27	116	70	43	134	26	170	190	238	50	80
		1 1/4	1 1/16	4 9/16	2 3/4	1 11/16	5 9/32	1.024	6 11/16	7 15/32	9 3/8	1 31/32	3 5/32
70 2 5/8 2 11/16 2 3/4	UEL314D1W3 UEL314-210D1W3 UEL314-211D1W3 UEL314-212D1W3	36	27	130	85	46	140	26	180	202	252	52	90
		1 13/32	1 1/16	5 1/8	3 11/32	1 13/16	5 1/2	1.024	7 3/32	7 15/16	9 29/32	2 1/16	3 17/32
75 2 13/16 2 7/8 2 15/16 3	UEL315D1W3 UEL315-213D1W3 UEL315-214D1W3 UEL315-215D1W3 UEL315-300D1W3	36	27	132	85	46	150	26	192	216	262	55	90
		1 13/32	1 1/16	5 3/16	3 11/32	1 13/16	5 29/32	1.024	7 9/16	8 1/2	10 5/16	2 5/32	3 17/32
80 3 1/16 3 1/8 3 3/16	UEL316D1W3 UEL316-301D1W3 UEL316-302D1W3 UEL316-303D1W3	42	30	150	98	53	160	30	204	230	282	60	102
		1 21/32	1 3/16	5 29/32	3 27/32	2 3/32	6 5/16	1.181	8 1/32	9 1/16	11 3/32	2 3/8	4 1/32

Note (1) These numbers indicate relubricatable type. If maintenance free type is needed, please order without suffix "D1".
Remarks Please refer to page A21 for size of grease fitting.

Nominal dimensions				Bearing number	Housing number	Mass of unit kg lb
mm inch						
r	L_1	B_1	S			
80	127	73	27.8	UEL311D1W3 UEL311-200D1W3 UEL311-201D1W3 UEL311-202D1W3 UEL311-203D1W3	T311D1 T311D1 T311D1 T311D1 T311D1	6.6 15
3 5/32	5	2.874	1.094			
85	135	79.4	30.95	UEL312D1W3 UEL312-204D1W3 UEL312-205D1W3 UEL312-206D1W3 UEL312-207D1W3	T312D1 T312D1 T312D1 T312D1 T312D1	7.9 17
3 11/32	5 5/16	3.126	1.219			
92	146	85.7	32.55	UEL313D1W3 UEL313-208D1W3 UEL313-209D1W3	T313D1 T313D1 T313D1	9.8 22
3 5/8	5 3/4	3.374	1.281			
97	155	92.1	34.15	UEL314D1W3 UEL314-210D1W3 UEL314-211D1W3 UEL314-212D1W3	T314D1 T314D1 T314D1 T314D1	11 24
3 13/16	6 3/32	3.626	1.344			
102	160	100	37.3	UEL315D1W3 UEL315-213D1W3 UEL315-214D1W3 UEL315-215D1W3 UEL315-300D1W3	T315D1 T315D1 T315D1 T315D1 T315D1	14 31
4 1/32	6 5/16	3.937	1.469			
108	174	106.4	40.5	UEL316D1W3 UEL316-301D1W3 UEL316-302D1W3 UEL316-303D1W3	T316D1 T316D1 T316D1 T316D1	17 37
4 1/4	6 27/32	4.189	1.594			

Take-up unit, cast housing Eccentric locking collar type

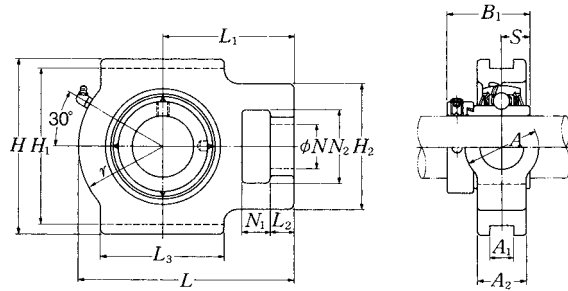

Shaft dia. mm inch	Unit number (1)	Nominal dimensions											
		mm inch											
		N_1	L_2	H_2	N_2	N	L_3	A_1	H_1	H	L	A_2	A
85 3 1/4 3 5/16 3 7/16	UELT317D1W3 UELT317-304D1W3 UELT317-305D1W3 UELT317-307D1W3	42	32	152	98	53	170	32	214	240	298	64	102
		1 21/32	1 1/4	5 31/32	3 27/32	2 3/32	6 11/16	1.260	8 27/64	9 7/16	11 23/32	2 17/32	4 1/32
90 3 7/16 3 1/2	UELT318D1W3 UELT318-307D1W3 UELT318-308D1W3	46	32	160	106	57	175	32	228	255	312	66	110
		1 13/16	1 1/4	6 5/16	4 3/16	2 1/4	6 7/8	1.260	8 31/32	10 1/32	12 9/32	2 19/32	4 11/32
95 3 5/8 3 11/16 3 3/4	UELT319D1W3 UELT319-310D1W3 UELT319-311D1W3 UELT319-312D1W3	46	33	165	106	57	180	35	240	270	322	72	110
		1 13/16	1 5/16	6 1/2	4 3/16	2 1/4	7 3/32	1.378	9 29/64	10 5/8	12 11/16	2 27/32	4 11/32
100 3 13/16 3 7/8 3 15/16 4	UELT320D1W3 UELT320-313D1W3 UELT320-314D1W3 UELT320-315D1W3 UELT320-400D1W3	48	34	175	115	59	200	35	260	290	345	75	120
		1 7/8	1 11/32	6 7/8	4 17/32	2 5/16	7 7/8	1.378	10 15/64	11 19/32	13 19/32	2 15/16	4 23/32
105	UELT321D1W3	48	34	175	115	59	200	35	260	290	347	75	120
110	UELT322D1W3	52	40	185	125	65	215	38	285	320	385	80	130

Note (1) These numbers indicate relubricatable type. If maintenance free type is needed, please order without suffix "D1".

Remarks Please refer to page A21 for size of grease fitting.

Nominal dimensions				Bearing number	Housing number	Mass of unit kg lb
mm inch						
r	L_1	B_1	S			
115	183	109.5	42.05	UELT317D1W3 UELT317-304D1W3 UELT317-305D1W3 UELT317-307D1W3	T317D1 T317D1 T317D1 T317D1	20 44
4 17/32	7 7/32	4.311	1.656			
120	192	115.9	43.65	UELT318D1W3 UELT318-307D1W3 UELT318-308D1W3	T318D1 T318D1 T318D1	23 51
4 23/32	7 9/16	4.563	1.719			
125	197	122.3	38.9	UELT319D1W3 UELT319-310D1W3 UELT319-311D1W3 UELT319-312D1W3	T319D1 T319D1 T319D1 T319D1	26 57
4 29/32	7 3/4	4.815	1.531			
135	210	128.6	50	UELT320D1W3 UELT320-313D1W3 UELT320-314D1W3 UELT320-315D1W3 UELT320-400D1W3	T320D1 T320D1 T320D1 T320D1 T320D1	32 71
5 5/16	8 9/32	5.063	1.969			
135	212	139.7	48.4	UELT321D1D1W3	T321D1	33
150	235	141.3	49.2	UELT322D1D1W3	T322D1	42

AELPT2 -

Take-up mini stretcher Units™ Eccentric locking collar type

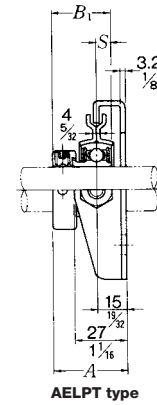
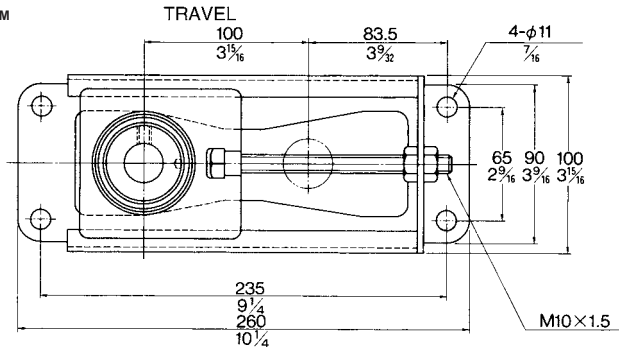

AELPT type

Shaft dia. mm inch	Unit number	Nominal dimensions			Bolt size mm inch	Max. load (1) recommended N lbf
		A	B ₁	S		
12 1/2	AELPT201-10W3	37.1	28.6	6.5	M10	3 430
	AELPT201-008-10W3	1 ²⁹ / ₆₄	1.126	0.256	3/8	770
15 9/16 5/8	AELPT202-10W3	37.1	28.6	6.5	M10	3 430
	AELPT202-009-10W3	1 ²⁹ / ₆₄	1.126	0.256	3/8	770
	AELPT202-010-10W3					
17 11/16	AELPT203-10W3	37.1	28.6	6.5	M10	3 430
	AELPT203-011-10W3	1 ²⁹ / ₆₄	1.126	0.256	3/8	770
20 3/4	AELPT204-10W3	38.5	31	7.5	M10	3 430
	AELPT204-012-10W3	1 ³³ / ₆₄	1.220	0.295	3/8	770
25 13/16 7/8 15/16	AELPT205-10W3	38.5	31	7.5	M10	3 430
	AELPT205-013-10W3					
	AELPT205-014-10W3					
	AELPT205-015-10W3	1 ³³ / ₆₄	1.220	0.295	3/8	770
1	AELPT205-100-10W3					

Bearing number	Mass of unit kg lb
AEL201W3	1.1
AEL201-008W3	2.4
AEL202W3	1.1
AEL202-009W3	2.4
AEL202-010W3	
AEL203W3	1.1
AEL203-011W3	2.4
AEL204W3	1.1
AEL204-012W3	2.4
AEL205W3	1.2
AEL205-013W3	
AEL205-014W3	
AEL205-015W3	2.6
AEL205-100W3	

Note (1) The Stretcher Units is designed to only take a horizontal radial load, in line with the adjustment direction. Axial loads or vertical radial loads can deform or break the housing.

Take-up mini stretcher Units™ Eccentric locking collar type

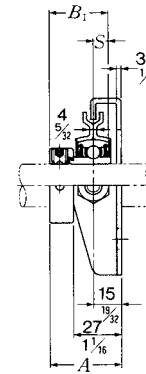
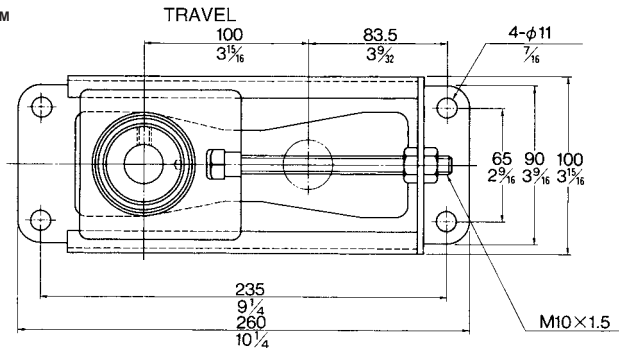

JELPT type

Shaft dia. mm inch	Unit number	Nominal dimensions			Bolt size mm inch	Max. load (1) recommended N lbf
		A	B ₁	S		
12 1/2	JELPT201-10W3	37.1	28.6	6.5	M10	3 430
	JELPT201-008-10W3	1 29/64	1.126	0.256	3/8	770
15 9/16 5/8	JELPT202-10W3	37.1	28.6	6.5	M10	3 430
	JELPT202-009-10W3	1 29/64	1.126	0.256	3/8	770
	JELPT202-010-10W3					
17 11/16	JELPT203-10W3	37.1	28.6	6.5	M10	3 430
	JELPT203-011-10W3	1 29/64	1.126	0.256	3/8	770
20 3/4	JELPT204-10W3	38.5	31	7.5	M10	3 430
	JELPT204-012-10W3	1 33/64	1.220	0.295	3/8	770
25 13/16 7/8 15/16	JELPT205-10W3	38.5	31	7.5	M10	3 430
	JELPT205-013-10W3					
	JELPT205-014-10W3					
	JELPT205-015-10W3	1 33/64	1.220	0.295	3/8	770
1	JELPT205-100-10W3					

Bearing number	Mass of unit kg lb
JEL201W3	1.1
JEL201-008W3	2.4
JEL202W3	1.1
JEL202-009W3	2.4
JEL202-010W3	
JEL203W3	1.1
JEL203-011W3	2.4
JEL204W3	1.1
JEL204-012W3	2.4
JEL205W3	1.2
JEL205-013W3	
JEL205-014W3	
JEL205-015W3	2.6
JEL205-100W3	

Note (1) The Stretcher Units is designed to only take a horizontal radial load, in line with the adjustment direction. Axial loads or vertical radial loads can deform or break the housing.

Cartridge unit, cast housing Eccentric locking collar type

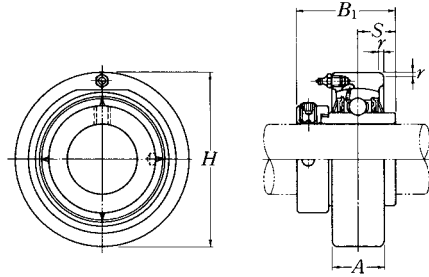

Shaft dia. mm inch	Unit number (*)	Nominal dimensions					Bearing number	Housing number	Mass of unit kg lb
		H	A	r	B ₁	S			
20 3/4	UELC204D1W3	72	20	2	43.7	17.1	UEL204D1W3	C204D1	0.6
	UELC204-012D1W3	2.8346	25/32	0.079	1.720	0.673	UEL204-012D1W3	C204D1	1.3
25 13/16 7/8 15/16	UELC205D1W3	80	22	2	44.4	17.45	UEL205D1W3	C205D1	0.7
	UELC205-013D1W3	3.1496	55/64	0.079	1.748	0.687	UEL205-013D1W3	C205D1	1.5
	UELC205-014D1W3						C205D1		
	UELC205-015D1W3						C205D1		
UELC205-100D1W3	C205D1								
30 1 1/16 1 1/8 1 3/16 1 1/4	UELC206D1W3	85	27	2	48.4	18.25	UEL206D1W3	C206D1	0.9
	UELC206-101D1W3	3.3465	1 1/16	0.079	1.906	0.719	UEL206-101D1W3	C206D1	2.0
	UELC206-102D1W3						C206D1		
	UELC206-103D1W3						C206D1		
UELC206-104D1W3	C206D1								
35 1 1/4 1 5/16 1 3/8 1 7/16	UELC207D1W3	90	28	2	51.1	18.8	UEL207D1W3	C207D1	1.0
	UELC207-104D1W3	3.5433	1 7/64	0.079	2.012	0.740	UEL207-104D1W3	C207D1	2.2
	UELC207-105D1W3						C207D1		
	UELC207-106D1W3						C207D1		
UELC207-107D1W3	C207D1								
40 1 1/2 1 9/16	UELC208D1W3	100	30	2.5	56.3	21.4	UEL208D1W3	C208D1	1.4
	UELC208-108D1W3	3.9370	1 3/16	0.098	2.217	0.843	UEL208-108D1W3	C208D1	3.1
	UELC208-109D1W3						C208D1		
45 1 5/8 1 11/16 1 3/4	UELC209D1W3	110	31	2.5	56.3	21.4	UEL209D1W3	C209D1	1.6
	UELC209-110D1W3	4.3307	1 7/32	0.098	2.217	0.843	UEL209-110D1W3	C209D1	3.5
	UELC209-111D1W3						C209D1		
UELC209-112D1W3	C209D1								

Note (*) These numbers indicate relubricatable type. If maintenance free type is needed, please order without suffix "D1".
Remarks Please refer to page A21 for size of grease fitting.

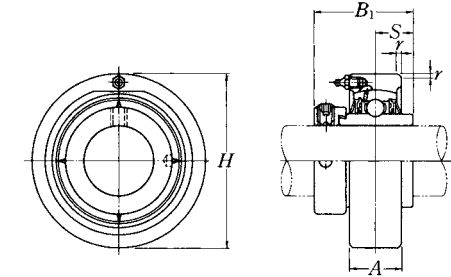

Shaft dia. mm inch	Unit number (*)	Nominal dimensions					Bearing number	Housing number	Mass of unit kg lb
		H	A	r	B ₁	S			
50 1 13/16 1 7/8 1 15/16 2	UELC210D1W3	120	33	2.5	62.7	24.6	UEL210D1W3	C210D1	2.1
	UELC210-113D1W3	4.7244	1 19/64	0.098	2.469	0.969	UEL210-113D1W3	C210D1	4.6
	UELC210-114D1W3						C210D1		
	UELC210-115D1W3						C210D1		
UELC210-200D1W3	C210D1								
55 2 2 1/16 2 1/8 2 3/16	UELC211D1W3	125	35	2.5	71.4	27.75	UEL211D1W3	C211D1	2.4
	UELC211-200D1W3	4.9213	1 3/8	0.098	2.811	1.093	UEL211-200D1W3	C211D1	5.3
	UELC211-201D1W3						C211D1		
	UELC211-202D1W3						C211D1		
UELC211-203D1W3	C211D1								
60 2 1/4 2 5/16 2 3/8 2 7/16	UELC212D1W3	130	38	2.5	77.8	30.95	UEL212D1W3	C212D1	2.8
	UELC212-204D1W3	5.1181	1 1/2	0.098	3.063	1.219	UEL212-204D1W3	C212D1	6.2
	UELC212-205D1W3						C212D1		
	UELC212-206D1W3						C212D1		
UELC212-207D1W3	C212D1								

Note (*) These numbers indicate relubricatable type. If maintenance free type is needed, please order without suffix "D1".
Remarks Please refer to page A21 for size of grease fitting.

Cartridge unit, cast housing Eccentric locking collar type

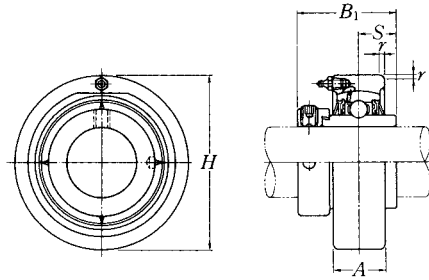

Shaft dia. mm inch	Unit number (1)	Nominal dimensions					Bearing number	Housing number	Mass of unit kg lb
		H	A	r	B ₁	S			
25 $\frac{13}{16}$ $\frac{7}{8}$ $\frac{15}{16}$ 1	UELC305D1W3	3.5433	26	2.5	46.8	16.7	UEL305D1W3	C305D1	1.0
	UELC305-013D1W3						UEL305-013D1W3	C305D1	
	UELC305-014D1W3						UEL305-014D1W3	C305D1	
	UELC305-015D1W3						UEL305-015D1W3	C305D1	
	UELC305-100D1W3						UEL305-100D1W3	C305D1	
30 $1\frac{1}{16}$ $1\frac{1}{8}$ $1\frac{3}{16}$	UELC306D1W3	3.9370	28	2.5	50	17.5	UEL306D1W3	C306D1	1.4
	UELC306-101D1W3						UEL306-101D1W3	C306D1	
	UELC306-102D1W3						UEL306-102D1W3	C306D1	
	UELC306-103D1W3						UEL306-103D1W3	C306D1	
35 $1\frac{1}{4}$ $1\frac{5}{16}$ $1\frac{3}{8}$ $1\frac{7}{16}$	UELC307D1W3	4.3307	32	3	51.6	18.3	UEL307D1W3	C307D1	1.8
	UELC307-104D1W3						UEL307-104D1W3	C307D1	
	UELC307-105D1W3						UEL307-105D1W3	C307D1	
	UELC307-106D1W3						UEL307-106D1W3	C307D1	
40 $1\frac{1}{2}$ $1\frac{9}{16}$	UELC308D1W3	4.7244	34	3	57.1	19.8	UEL308D1W3	C308D1	2.3
	UELC308-108D1W3						UEL308-108D1W3	C308D1	
	UELC308-109D1W3						UEL308-109D1W3	C308D1	
45 $1\frac{5}{8}$ $1\frac{11}{16}$ $1\frac{3}{4}$	UELC309D1W3	5.1181	38	3.5	58.7	19.8	UEL309D1W3	C309D1	2.9
	UELC309-110D1W3						UEL309-110D1W3	C309D1	
	UELC309-111D1W3						UEL309-111D1W3	C309D1	
	UELC309-112D1W3						UEL309-112D1W3	C309D1	
50 $1\frac{13}{16}$ $1\frac{7}{8}$ $1\frac{15}{16}$	UELC310D1W3	5.5118	40	3.5	66.6	24.6	UEL310D1W3	C310D1	3.5
	UELC310-113D1W3						UEL310-113D1W3	C310D1	
	UELC310-114D1W3						UEL310-114D1W3	C310D1	
	UELC310-115D1W3						UEL310-115D1W3	C310D1	

Note (1) These numbers indicate relubricatable type. If maintenance free type is needed, please order without suffix "D1".

Remarks Please refer to page A21 for size of grease fitting.

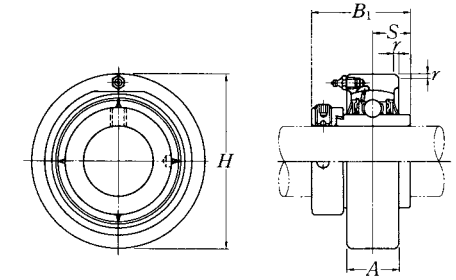

Shaft dia. mm inch	Unit number (1)	Nominal dimensions					Bearing number	Housing number	Mass of unit kg lb
		H	A	r	B ₁	S			
55 2 $2\frac{1}{16}$ $2\frac{1}{8}$ $2\frac{3}{16}$	UELC311D1W3	5.9055	44	3.5	73	27.8	UEL311D1W3	C311D1	4.3
	UELC311-200D1W3						UEL311-200D1W3	C311D1	
	UELC311-201D1W3						UEL311-201D1W3	C311D1	
	UELC311-202D1W3						UEL311-202D1W3	C311D1	
	UELC311-203D1W3						UEL311-203D1W3	C311D1	
60 $2\frac{1}{4}$ $2\frac{5}{16}$ $2\frac{3}{8}$ $2\frac{7}{16}$	UELC312D1W3	6.2992	46	3.5	79.4	30.95	UEL312D1W3	C312D1	5.1
	UELC312-204D1W3						UEL312-204D1W3	C312D1	
	UELC312-205D1W3						UEL312-205D1W3	C312D1	
	UELC312-206D1W3						UEL312-206D1W3	C312D1	
65 $2\frac{1}{2}$ $2\frac{9}{16}$	UELC313D1W3	6.6929	50	3.5	85.7	32.55	UEL313D1W3	C313D1	6.2
	UELC313-208D1W3						UEL313-208D1W3	C313D1	
	UELC313-209D1W3						UEL313-209D1W3	C313D1	
70 $2\frac{5}{8}$ $2\frac{11}{16}$ $2\frac{3}{4}$	UELC314D1W3	7.0866	52	4	92.1	34.15	UEL314D1W3	C314D1	7.3
	UELC314-210D1W3						UEL314-210D1W3	C314D1	
	UELC314-211D1W3						UEL314-211D1W3	C314D1	
75 $2\frac{5}{8}$ $2\frac{7}{8}$ $2\frac{15}{16}$ 3	UELC315D1W3	7.4803	55	4	100	37.3	UEL315D1W3	C315D1	8.5
	UELC315-213D1W3						UEL315-213D1W3	C315D1	
	UELC315-214D1W3						UEL315-214D1W3	C315D1	
	UELC315-215D1W3						UEL315-215D1W3	C315D1	
80 $3\frac{1}{16}$ $3\frac{1}{8}$ $3\frac{3}{16}$	UELC316D1W3	7.8740	60	4	106.4	40.5	UEL316D1W3	C316D1	10
	UELC316-301D1W3						UEL316-301D1W3	C316D1	
	UELC316-302D1W3						UEL316-302D1W3	C316D1	
	UELC316-303D1W3						UEL316-303D1W3	C316D1	

Note (1) These numbers indicate relubricatable type. If maintenance free type is needed, please order without suffix "D1".

Remarks Please refer to page A21 for size of grease fitting.

Cartridge unit, cast housing Eccentric locking collar type

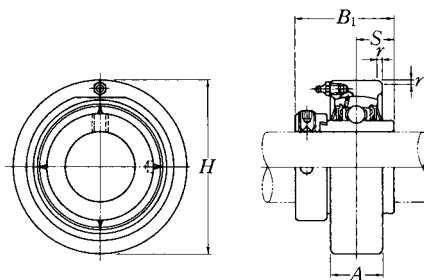

Shaft dia. mm inch	Unit number ⁽¹⁾	Nominal dimensions mm inch					Bearing number	Housing number	Mass of unit kg lb
		H	A	r	B ₁	S			
85 3 1/4	UELC317D1W3	215	64	4	109.5	42.05	UEL317D1W3	C317D1	13
3 5/16	UELC317-304D1W3	8.4646	2 33/64	0.157	4.311	1.656	UEL317-304D1W3	C317D1	29
3 7/16	UELC317-305D1W3						UEL317-305D1W3	C317D1	
3 7/16	UELC317-307D1W3						UEL317-307D1W3	C317D1	
90 3 7/16 3 1/2	UELC318D1W3	225	66	4	115.9	43.65	UEL318D1W3	C318D1	14
3 7/16	UELC318-307D1W3	8.8583	2 19/32	0.157	4.563	1.719	UEL318-307D1W3	C318D1	31
3 1/2	UELC318-308D1W3						UEL318-308D1W3	C318D1	
95 3 5/8 3 11/16 3 3/4	UELC319D1W3	240	72	4	122.3	38.9	UEL319D1W3	C319D1	17
3 5/8	UELC319-310D1W3	9.4488	2 53/64	0.157	4.815	1.531	UEL319-310D1W3	C319D1	37
3 11/16	UELC319-311D1W3						UEL319-311D1W3	C319D1	
3 3/4	UELC319-312D1W3						UEL319-312D1W3	C319D1	
100 3 13/16 3 7/8 3 15/16 4	UELC320D1W3	260	75	4	128.6	50	UEL320D1W3	C320D1	22
3 13/16	UELC320-313D1W3	10.2362	2 61/64	0.157	5.063	1.969	UEL320-313D1W3	C320D1	49
3 7/8	UELC320-314D1W3						UEL320-314D1W3	C320D1	
3 15/16	UELC320-315D1W3						UEL320-315D1W3	C320D1	
4	UELC320-400D1W3						UEL320-400D1W3	C320D1	
105	UELC321D1W3	260	75	4	139.7	48.4	UEL321D1W3	C321D1	21
110	UELC322D1W3	300	80	5	141.3	49.2	UEL322D1W3	C322D1	31

Note ⁽¹⁾ These numbers indicate relubricatable type. If maintenance free type is needed, please order without suffix "D1".

Remarks Please refer to page **A21** for size of grease fitting.

Pillow block unit, cast housing Adapter type

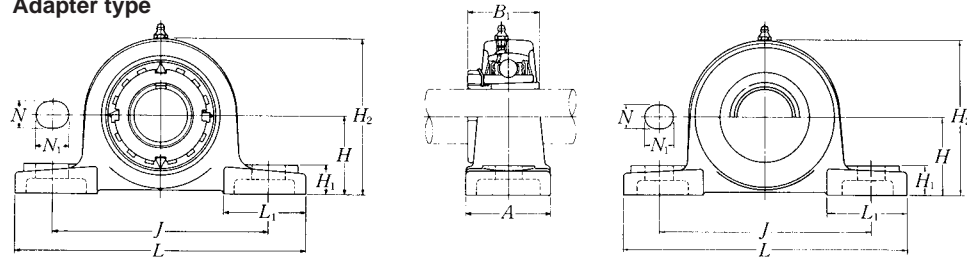

Pressed steel dust cover type
Open end **Z-UKP...D1**
Closed end **ZM-UKP...D1**

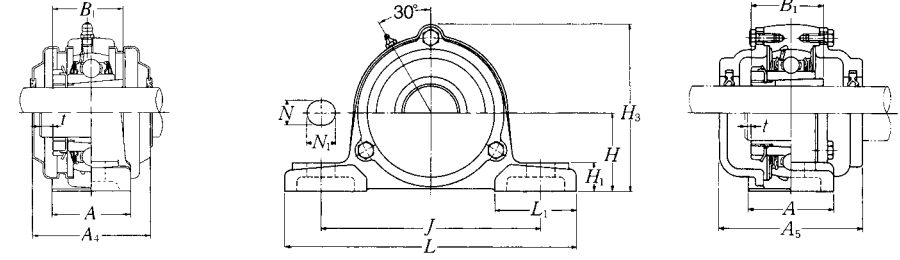

Cast dust cover type
Open end **C-UKP...D1**
Closed end **CM-UKP...D1**

Shaft dia. mm inch	Unit number ⁽¹⁾ / ₍₂₎ / ₍₃₎	Nominal dimensions										Bolt size mm inch	Bearing number
		mm inch											
		H	L	J	A	N	N ₁	H ₁	H ₂	L ₁	B ₁		
20 3/4	UKP205D1;H2305X UKP205D1;HE2305	36.5 1 7/16	140 5 1/2	105 4 1/8	38 1 1/2	13 1/2	16 5/8	15 19/32	71 2 25/32	42 1 21/32	35 1.378	M10 3/8	UK205D1;H2305X UK205D1;HE2305
25 7/8 1	UKP206D1;H2306X UKP206D1;HS2306 UKP206D1;HE2306X	42.9 1 11/16	165 6 1/2	121 4 3/4	48 1 7/8	17 21/32	20 25/32	17 21/32	83 3 9/32	54 2 1/8	38 1.496	M14 1/2	UK206D1;H2306X UK206D1;HS2306 UK206D1;HE2306X
30 1 1/8	UKP207D1;H2307X UKP207D1;HS2307	47.6 1 7/8	167 6 9/16	127 5	48 1 7/8	17 21/32	20 25/32	18 23/32	93 3 21/32	54 2 1/8	43 1.693	M14 1/2	UK207D1;H2307X UK207D1;HS2307
35 1 1/4 1 3/8	UKP208D1;H2308X UKP208D1;HE2308X UKP208D1;HS2308X	49.2 1 15/16	184 7 1/4	137 5 13/32	54 2 1/8	17 21/32	20 25/32	18 23/32	98 3 27/32	52 2 1/16	46 1.811	M14 1/2	UK208D1;H2308X UK208D1;HE2308X UK208D1;HS2308X
40 1 7/16 1 1/2 1 5/8	UKP209D1;H2309X UKP209D1;HA2309 UKP209D1;HE2309X UKP209D1;HS2309X	54 2 1/8	190 7 15/32	146 5 3/4	54 2 1/8	17 21/32	20 25/32	20 25/32	106 4 3/16	60 2 3/8	50 1.969	M14 1/2	UK209D1;H2309X UK209D1;HA2309 UK209D1;HE2309X UK209D1;HS2309X
45 1 5/8 1 11/16 1 3/4	UKP210D1;H2310X UKP210D1;HS2310 UKP210D1;HA2310 UKP210D1;HE2310X	57.2 2 1/4	206 8 1/8	159 6 1/4	60 2 3/8	20 25/32	23 29/32	21 13/16	114 4 1/2	65 2 9/16	55 2.165	M16 5/8	UK210D1;H2310X UK210D1;HS2310 UK210D1;HA2310 UK210D1;HE2310X
50 1 7/8 1 5/16 2	UKP211D1;H2311X UKP211D1;HS2311 UKP211D1;HA2311 UKP211D1;HE2311XY	63.5 2 1/2	219 8 3/8	171 6 29/32	60 2 3/8	20 25/32	23 29/32	23 29/32	126 4 31/32	65 2 9/16	59 2.323	M16 5/8	UK211D1;H2311X UK211D1;HS2311 UK211D1;HA2311 UK211D1;HE2311XY
55 2 1/8	UKP212D1;H2312X UKP212D1;HS2312	69.8 2 3/4	241 9 1/2	184 7 1/4	70 2 3/4	20 25/32	23 29/32	25 31/32	138 5 7/16	70 2 3/4	62 2.441	M16 5/8	UK212D1;H2312X UK212D1;HS2312

Notes (1) These numbers indicate relubricatable type. If maintenance free type is needed, please order without suffix "D1".
(2) Adapter number with suffix "X" means a narrow slot type adapter sleeve.
In this case the lock washer with the straight inner prong should be used.
(3) For HE2311XY, screw thread pitch different from the standard is applied, because of the thin thread section of sleeve.
To distinguish it, a suffix "Y" is added.

Remarks Please refer to page A21 for size of grease fitting.

Housing number	Unit number pressed steel dust cover type	Unit number cast dust cover type	Nominal dimensions				Mass of unit		
			mm inch				kg lb		
			t max.	A ₄	H ₃	A ₅	UKP	Z(ZM)	C(CM)
P205D1	Z(ZM)-UKP205D1;H2305X	C(CM)-UKP205D1;H2305X	2 5/64	48 1 29/32	76 3	70 2 3/4	0.8 1.8	0.9 2.0	1.2 2.6
P206D1	Z(ZM)-UKP206D1;H2306X	C(CM)-UKP206D1;H2306X	2 5/64	53 2 3/32	88 3 15/32	75 2 5/16	1.4 3.1	1.5 3.3	1.8 4.0
P207D1	Z(ZM)-UKP207D1;H2307X	C(CM)-UKP207D1;H2307X	3 1/8	60 2 3/8	99 3 29/32	80 3 5/32	1.7 3.7	1.8 4.0	2.1 4.6
P208D1	Z(ZM)-UKP208D1;H2308X	C(CM)-UKP208D1;H2308X	3 1/8	69 2 23/32	105 4 1/8	90 3 11/32	2.0 4.4	2.2 4.9	2.8 6.2
P209D1	Z(ZM)-UKP209D1;H2309X	C(CM)-UKP209D1;H2309X	3 1/8	69 2 23/32	113 4 7/16	95 3 3/4	2.3 5.1	2.5 5.5	3.3 7.3
P210D1	Z(ZM)-UKP210D1;H2310X	C(CM)-UKP210D1;H2310X	3 1/8	76 3	119 4 11/16	100 3 5/16	2.9 6.4	3.0 6.6	3.9 8.6
P211D1	Z(ZM)-UKP211D1;H2311X	C(CM)-UKP211D1;H2311X	4 5/32	77 3 1/32	130 5 1/8	100 3 5/16	3.6 7.9	3.7 8.2	4.8 11
P212D1	Z(ZM)-UKP212D1;H2312X	C(CM)-UKP212D1;H2312X	4 5/32	89 3 1/2	143 5 5/8	115 4 7/32	4.7 10	5.1 11	6.2 14

Pillow block unit, cast housing Adapter type

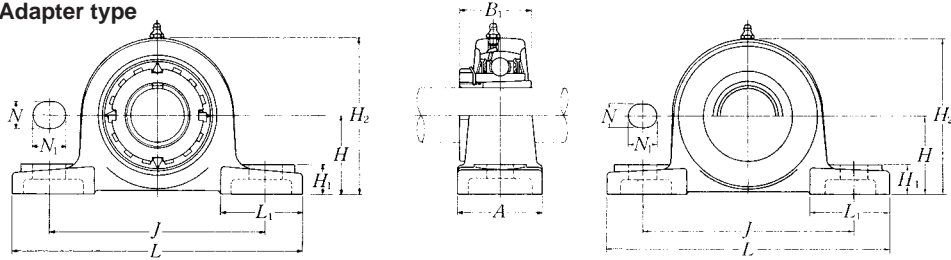

Pressed steel dust cover type
Open end **Z-UKP...D1**
Closed end **ZM-UKP...D1**

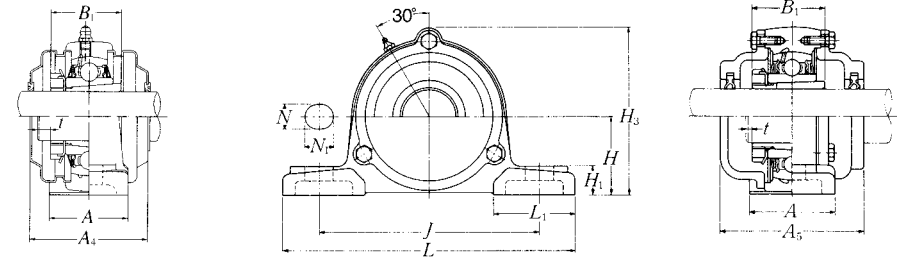

Cast dust cover type
Open end **C-UKP...D1**
Closed end **CM-UKP...D1**

Shaft dia. mm inch	Unit number ⁽¹⁾⁽²⁾	Nominal dimensions										Bolt size mm inch	Bearing number
		H	L	J	A	N	N ₁	H ₁	H ₂	L ₁	B ₁		
60 2 3/16 2 1/4 2 3/8	UKP213D1;H2313X UKP213D1;HA2313 UKP213D1;HE2313X UKP213D1;HS2313X	76.2	265	203	70	25	28	27	151	77	65	M20	UK213D1;H2313X UK213D1;HA2313 UK213D1;HE2313X UK213D1;HS2313X
65 2 7/16 2 1/2	UKP215D1;H2315X UKP215D1;HA2315 UKP215D1;HE2315X	82.6	275	217	74	25	28	28	163	80	73	M20	UK215D1;H2315X UK215D1;HA2315 UK215D1;HE2315X
70 2 11/16 2 3/4	UKP216D1;H2316X UKP216D1;HA2316 UKP216D1;HE2316X	88.9	292	232	78	25	28	30	175	85	78	M20	UK216D1;H2316X UK216D1;HA2316 UK216D1;HE2316X
75 2 15/16 3	UKP217D1;H2317X UKP217D1;HA2317X UKP217D1;HE2317X	95.2	310	247	83	25	28	32	187	85	82	M20	UK217D1;H2317X UK217D1;HA2317X UK217D1;HE2317X
80 3 3/16	UKP218D1;H2318X UKP218D1;HA2318X	101.6	327	262	88	27	30	33	200	90	86	M22	UK218D1;H2318X UK218D1;HA2318X

Housing number	Unit number pressed steel dust cover type	Unit number cast dust cover type	Nominal dimensions				Mass of unit		
			t max.	A ₄ mm inch	H ₃	A ₅	UKP	Z(ZM)	C(CM)
P213D1 P213D1 P213D1 P213D1	Z(ZM)-UKP213D1;H2313X Z(ZM)-UKP213AD1;HA2313 Z(ZM)-UKP213ED1;HE2313X Z(ZM)-UKP213SD1;HS2313X	C(CM)-UKP213D1;H2313X C(CM)-UKP213AD1;HA2313 C(CM)-UKP213ED1;HE2313X C(CM)-UKP213SD1;HS2313X	4 5/32	91 3 19/32	155 6 3/32	120 4 23/32	5.7 13	5.9 13	7.6 17
P215D1 P215D1 P215D1	— — —	C(CM)-UKP215D1;H2315X C(CM)-UKP215AD1;HA2315 C(CM)-UKP215ED1;HE2315X	4 5/32	— —	168 6 5/8	135 5 5/16	7.5 17	— —	10 22
P216D1 P216D1 P216D1	— — —	C(CM)-UKP216D1;H2316X C(CM)-UKP216AD1;HA2316 C(CM)-UKP216ED1;HE2316X	4 5/32	— —	181 7 1/8	145 5 23/32	9.2 20	— —	12 26
P217D1 P217D1 P217D1	— — —	C(CM)-UKP217D1;H2317X C(CM)-UKP217AD1;HA2317X C(CM)-UKP217ED1;HE2317X	5 13/64	— —	191 7 17/32	155 6 3/32	11 24	— —	14 31
P218D1 P218D1	— —	C(CM)-UKP218D1;H2318X C(CM)-UKP218AD1;HA2318X	5 13/64	— —	204 8 1/32	165 6 1/2	13 29	— —	16 35

Notes ⁽¹⁾ These numbers indicate relubricatable type. If maintenance free type is needed, please order without suffix "D1".

⁽²⁾ Adapter number with suffix "X" means a narrow slot type adapter sleeve.
In this case the lock washer with the straight inner prong should be used.

Remarks Please refer to page A21 for size of grease fitting.

Pillow block unit, cast housing Adapter type

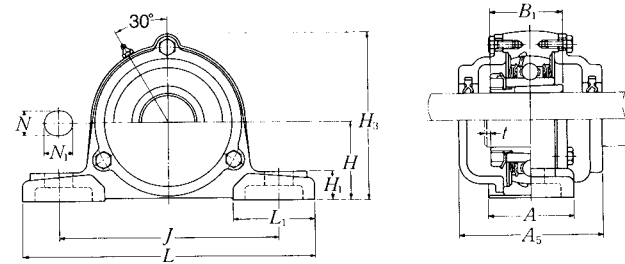
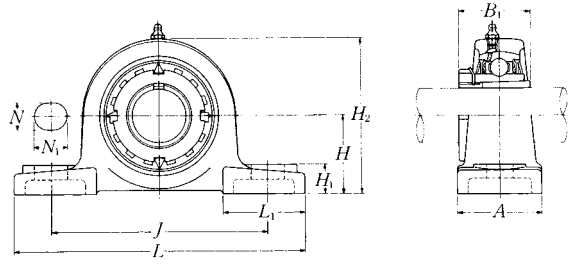

Cast dust cover type
Open end **C-UKP...D1**
Closed end **CM-UKP...D1**

Shaft dia. mm inch	Unit number ⁽¹⁾ / ₍₂₎ / ₍₃₎	Nominal dimensions										Bolt size mm inch
		mm inch										
		H	L	J	A	N	N ₁	H ₁	H ₂	L ₁	B ₁	
20 3/4	UKP305D1;H2305X UKP305D1;HE2305	45 1 49/64	175 6 7/8	132 5 3/16	45 1 25/32	17 2 1/32	20 2 5/32	15 1 9/32	85 3 11/32	54 2 1/8	35 1.378	M14 1/2
25 7/8 1	UKP306D1;H2306X UKP306D1;HS2306 UKP306D1;HE2306X	50 1 31/32	180 7 3/32	140 5 1/2	50 1 31/32	17 2 1/32	20 2 5/32	18 2 3/32	95 3 3/4	54 2 1/8	38 1.496	M14 1/2
30 1 1/8	UKP307D1;H2307X UKP307D1;HS2307	56 2 13/64	210 8 9/32	160 6 5/16	56 2 7/32	17 2 1/32	25 3 1/32	20 2 5/32	106 4 3/16	60 2 3/8	43 1.693	M14 1/2
35 1 1/4 1 3/8	UKP308D1;H2308X UKP308D1;HE2308X UKP308D1;HS2308X	60 2 23/64	220 8 21/32	170 6 11/16	60 2 3/8	17 2 1/32	27 1 1/16	22 7/8	116 4 9/16	60 2 3/8	46 1.811	M14 1/2
40 1 7/16 1 1/2 1 5/8	UKP309D1;H2309X UKP309D1;HA2309 UKP309D1;HE2309X UKP309D1;HS2309X	67 2 41/64	245 9 21/32	190 7 15/32	67 2 5/8	20 2 5/32	30 1 3/16	24 1 5/16	129 5 3/32	65 2 9/16	50 1.969	M16 5/8
45 1 5/8 1 11/16 1 3/4	UKP310D1;H2310X UKP310D1;HS2310 UKP310D1;HA2310 UKP310D1;HE2310X	75 2 61/64	275 10 13/16	212 8 11/32	75 2 15/16	20 2 5/32	35 1 3/8	27 1 1/16	143 5 5/8	75 2 15/16	55 2.165	M16 5/8
50 1 7/8 1 15/16 2	UKP311D1;H2311X UKP311D1;HS2311 UKP311D1;HA2311 UKP311D1;HE2311XY	80 3 5/32	310 12 7/32	236 9 9/32	80 3 5/32	20 2 5/32	38 1 1/2	30 1 3/16	154 6 1/16	85 3 11/32	59 2.323	M16 5/8
55 2 1/8	UKP312D1;H2312X UKP312D1;HS2312	85 3 11/32	330 13	250 9 27/32	85 3 11/32	25 3 1/32	38 1 1/2	32 1 1/4	165 6 1/2	95 3 3/4	62 2.441	M20 3/4

Notes ⁽¹⁾ These numbers indicate relubricatable type. If maintenance free type is needed, please order without suffix "D1".

⁽²⁾ Adapter number with suffix "X" means a narrow slot type adapter sleeve.

In this case the lock washer with the straight inner prong should be used.

⁽³⁾ For HE2311XY, screw thread pitch different from the standard is applied, because of the thin thread section of sleeve. To distinguish it, a suffix "Y" is added.

Remarks Please refer to page A21 for size of grease fitting.

Bearing number	Housing number	Unit number cast dust cover type	Nominal dimensions			Mass of unit	
			mm inch			kg lb	
			t max.	H ₃	A ₅	UKP	C(CM)
UK305D1;H2305X UK305D1;HE2305	P305D1 P305D1	C(CM)-UKP305D1;H2305X C(CM)-UKP305ED1;HE2305	2 5/64	91 3 19/32	80 3 5/32	1.4 3.1	1.9 4.2
UK306D1;H2306X UK306D1;HS2306 UK306D1;HE2306X	P306D1 P306D1 P306D1	C(CM)-UKP306D1;H2306X C(CM)-UKP306SD1;HS2306 C(CM)-UKP306ED1;HE2306X	2 5/64	105 4 1/8	85 3 11/32	1.8 4.0	2.6 5.7
UK307D1;H2307X UK307D1;HS2307	P307D1 P307D1	C(CM)-UKP307D1;H2307X C(CM)-UKP307SD1;HS2307	3 1/8	115 4 1/32	95 3 3/4	2.6 5.7	3.3 7.3
UK308D1;H2308X UK308D1;HE2308X UK308D1;HS2308X	P308D1 P308D1 P308D1	C(CM)-UKP308D1;H2308X C(CM)-UKP308ED1;HE2308X C(CM)-UKP308SD1;HS2308X	3 1/8	125 4 29/32	105 4 1/8	3.1 6.8	4.2 9.3
UK309D1;H2309X UK309D1;HA2309 UK309D1;HE2309X UK309D1;HS2309X	P309D1 P309D1 P309D1 P309D1	C(CM)-UKP309D1;H2309X C(CM)-UKP309AD1;HA2309 C(CM)-UKP309ED1;HE2309X C(CM)-UKP309SD1;HS2309X	3 1/8	140 5 1/2	110 4 11/32	4.1 9.0	5.6 12
UK310D1;H2310X UK310D1;HS2310 UK310D1;HA2310 UK310D1;HE2310X	P310D1 P310D1 P310D1 P310D1	C(CM)-UKP310D1;H2310X C(CM)-UKP310SD1;HS2310 C(CM)-UKP310AD1;HA2310 C(CM)-UKP310ED1;HE2310X	3 1/8	156 6 5/32	120 4 23/32	5.6 12	7.2 16
UK311D1;H2311X UK311D1;HS2311 UK311D1;HA2311 UK311D1;HE2311XY	P311D1 P311D1 P311D1 P311D1	C(CM)-UKP311D1;H2311X C(CM)-UKP311SD1;HS2311 C(CM)-UKP311AD1;HA2311 C(CM)-UKP311ED1;HE2311XY	4 5/32	166 6 7/32	125 4 29/32	7.3 16	9.0 20
UK312D1;H2312X UK312D1;HS2312	P312D1 P312D1	C(CM)-UKP312D1;H2312X C(CM)-UKP312SD1;HS2312	4 5/32	179 7 1/16	135 5 5/16	9.3 21	11 24

Pillow block unit, cast housing Adapter type

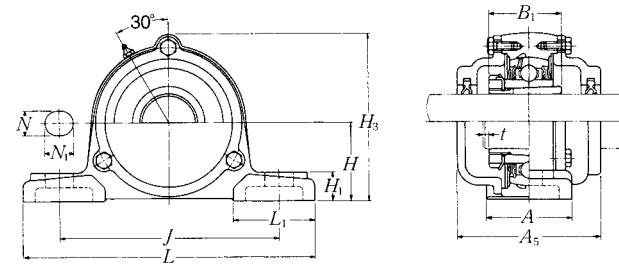
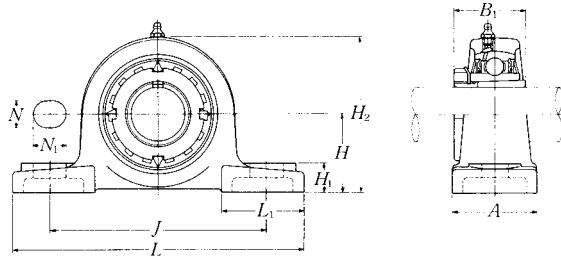

Cast dust cover type
Open end **C-UKP...D1**
Closed end **CM-UKP...D1**

Shaft dia. mm inch	Unit number ⁽¹⁾⁽²⁾	Nominal dimensions										Bolt size mm inch
		mm inch										
		H	L	J	A	N	N ₁	H ₁	H ₂	L ₁	B ₁	
60 2 3/16 2 1/4 2 3/8	UKP313D1;H2313X UKP313D1;HA2313 UKP313D1;HE2313X UKP313D1;HS2313X	90 3 5/8	340 13 3/8	260 10 1/4	90 3 17/32	25 3 1/32	38 1 1/2	33 1 5/16	176 6 15/16	105 4 1/8	65 2.559	M20 3/4
65 2 7/16 2 1/2	UKP315D1;H2315X UKP315D1;HA2315 UKP315D1;HE2315X	100 3 15/16	380 14 31/32	290 11 13/32	100 3 15/16	27 1 1/16	40 1 9/16	35 1 3/8	198 7 25/32	110 4 11/32	73 2.874	M22 7/8
70 2 11/16 2 3/4	UKP316D1;H2316X UKP316D1;HA2316 UKP316D1;HE2316X	106 4 11/64	400 15 3/4	300 11 13/16	110 4 11/32	27 1 1/16	40 1 9/16	40 1 9/16	210 8 9/32	110 4 11/32	78 3.071	M22 7/8
75 2 15/16 3	UKP317D1;H2317X UKP317D1;HA2317X UKP317D1;HE2317X	112 4 13/32	420 16 17/32	320 12 19/32	110 4 11/32	33 1 5/16	45 1 25/32	40 1 9/16	220 8 21/32	120 4 23/32	82 3.228	M27 1
80 3 3/16	UKP318D1;H2318X UKP318D1;HA2318X	118 4 41/64	430 16 15/16	330 13	110 4 11/32	33 1 5/16	45 1 25/32	45 1 25/32	235 9 1/4	120 4 23/32	86 3.386	M27 1
85 3 1/4	UKP319D1;H2319X UKP319D1;HE2319X	125 4 59/64	470 18 1/2	360 14 3/16	120 4 23/32	35 1 13/32	50 1 31/32	45 1 25/32	250 9 27/32	125 4 29/32	90 3.543	M30 1 1/8
90 3 7/16 3 1/2	UKP320D1;H2320X UKP320D1;HA2320 UKP320D1;HE2320X	140 5 33/64	490 19 9/32	380 14 31/32	120 4 23/32	36 1 13/32	50 1 31/32	50 1 31/32	275 10 13/16	130 5 1/8	97 3.819	M30 1 1/8
100	UKP322D1;H2322X	150	520	400	140	40	55	55	300	135	105	M33
110	UKP324D1;H2324X	160	570	450	140	40	55	65	320	140	112	M33
115	UKP326D1;H2326	180	600	480	140	40	55	75	355	140	121	M33
125	UKP328D1;H2328	200	620	500	140	40	55	75	390	140	131	M33

Notes ⁽¹⁾ These numbers indicate relubricatable type. If maintenance free type is needed, please order without suffix "D1".

⁽²⁾ Adapter number with suffix "X" means a narrow slot type adapter sleeve.
In this case the lock washer with the straight inner prong should be used.

Remarks Please refer to page A21 for size of grease fitting.

Bearing number	Housing number	Unit number cast dust cover type	Nominal dimensions			Mass of unit	
			mm inch			kg lb	
			t max.	H ₃	A ₅	UKP	C(CM)
UK313D1;H2313X UK313D1;HA2313 UK313D1;HE2313X UK313D1;HS2313X	P313D1 P313D1 P313D1 P313D1	C(CM)-UKP313D1;H2313X C(CM)-UKP313AD1;HA2313 C(CM)-UKP313ED1;HE2313X C(CM)-UKP313SD1;HS2313X	4 5/32	190 7 15/32	140 5 1/2	10 22	12 26
UK315D1;H2315X UK315D1;HA2315 UK315D1;HE2315X	P315D1 P315D1 P315D1	C(CM)-UKP315D1;H2315X C(CM)-UKP315AD1;HA2315 C(CM)-UKP315ED1;HE2315X	4 5/32	210 8 9/32	150 5 29/32	14 31	18 40
UK316D1;H2316X UK316D1;HA2316 UK316D1;HE2316X	P316D1 P316D1 P316D1	C(CM)-UKP316D1;H2316X C(CM)-UKP316AD1;HA2316 C(CM)-UKP316ED1;HE2316X	4 5/32	221 8 11/16	155 6 3/32	17 37	21 46
UK317D1;H2317X UK317D1;HA2317X UK317D1;HE2317X	P317D1 P317D1 P317D1	C(CM)-UKP317D1;H2317X C(CM)-UKP317AD1;HA2317X C(CM)-UKP317ED1;HE2317X	5 13/64	235 9 1/4	170 6 11/16	19 42	24 53
UK318D1;H2318X UK318D1;HA2318X	P318D1 P318D1	C(CM)-UKP318D1;H2318X C(CM)-UKP318AD1;HA2318X	5 13/64	246 9 11/16	170 6 11/16	22 49	28 62
UK319D1;H2319X UK319D1;HE2319X	P319D1 P319D1	C(CM)-UKP319D1;H2319X C(CM)-UKP319ED1;HE2319X	5 13/64	258 10 5/32	180 7 3/32	27 60	33 73
UK320D1;H2320X UK320D1;HA2320 UK320D1;HE2320X	P320D1 P320D1 P320D1	C(CM)-UKP320D1;H2320X C(CM)-UKP320AD1;HA2320 C(CM)-UKP320ED1;HE2320X	5 13/64	283 11 5/32	190 7 15/32	33 73	40 88
UK322D1;H2322X	P322D1	C(CM)-UKP322D1;H2322X	5	313	200	43	53
UK324D1;H2324X	P324D1	C(CM)-UKP324D1;H2324X	5	335	215	50	67
UK326D1;H2326	P326D1	C(CM)-UKP326D1;H2326	6	375	225	69	86
UK328D1;H2328	P328D1	C(CM)-UKP328D1;H2328	6	407	235	84	101

Pillow block unit, cast housing Adapter type

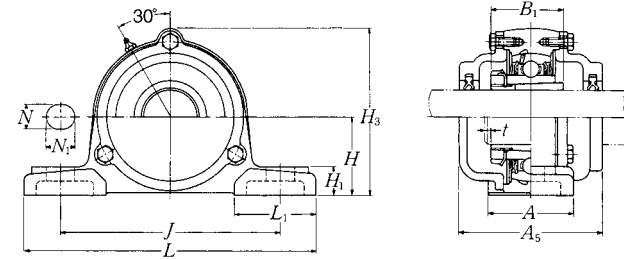
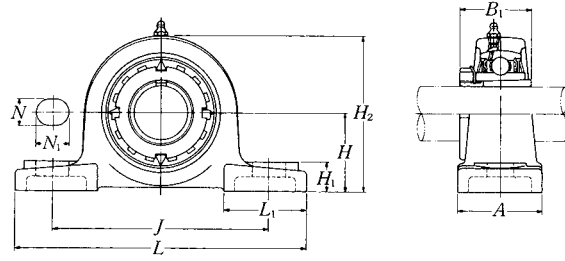

Cast dust cover type
Open end **C-UKP...D1**
Closed end **CM-UKP...D1**

Shaft dia. mm inch	Unit number ⁽¹⁾⁽²⁾⁽³⁾	Nominal dimensions										Bolt size mm inch
		mm inch										
		H	L	J	A	N	N ₁	H ₁	H ₂	L ₁	B ₁	
20 3/4	UKPX05D1;H2305X UKPX05D1;HE2305	44.4 1 3/4	159 6 1/4	119 4 11/16	51 2	17 21/32	20 25/32	18 23/32	85 3 11/32	50 1 31/32	35 1.378	M14 1/2
25 7/8 1	UKPX06D1;H2306X UKPX06D1;HS2306 UKPX06D1;HE2306X	47.6 1 7/8	175 6 7/8	127 5	57 2 1/4	17 21/32	20 25/32	20 25/32	93 3 21/32	54 2 1/8	38 1.496	M14 1/2
30 1 1/8	UKPX07D1;H2307X UKPX07D1;HS2307	54 2 1/8	203 8	144 5 21/32	57 2 1/4	17 21/32	20 25/32	21 1 1/16	105 4 1/8	60 2 3/8	43 1.693	M14 1/2
35 1 1/4 1 3/8	UKPX08D1;H2308X UKPX08D1;HE2308X UKPX08D1;HS2308X	58.7 2 5/16	222 8 3/4	156 6 5/32	67 2 5/8	20 25/32	23 29/32	26 1 1/32	111 4 3/8	65 2 9/16	46 1.811	M16 5/8
40 1 1/16 1 1/2 1 5/8	UKPX09D1;H2309X UKPX09D1;HA2309 UKPX09D1;HE2309X UKPX09D1;HS2309X	58.7 2 5/16	222 8 3/4	156 6 5/32	67 2 5/8	20 25/32	23 29/32	26 1 1/32	116 4 9/16	65 2 9/16	50 1.969	M16 5/8
45 1 5/8 1 11/16 1 3/4	UKPX10D1;H2310X UKPX10D1;HS2310 UKPX10D1;HA2310 UKPX10D1;HE2310X	63.5 2 1/2	241 9 1/2	171 6 23/32	73 2 7/8	20 25/32	23 29/32	27 1 1/16	126 4 31/32	70 2 3/4	55 2.165	M16 5/8
50 1 7/8 1 15/16 2	UKPX11D1;H2311X UKPX11D1;HS2311 UKPX11D1;HA2311 UKPX11D1;HE2311XY	69.8 2 3/4	260 10 1/4	184 7 1/4	79 3 1/8	25 31/32	28 1 3/32	30 1 3/16	137 5 13/32	75 2 15/16	59 2.323	M20 3/4
55 2 1/8	UKPX12D1;H2312X UKPX12D1;HS2312	76.2 3	286 11 1/4	203 8	83 3 3/32	25 31/32	28 1 3/32	33 1 5/16	151 5 15/16	80 3 3/32	62 2.441	M20 3/4

Bearing number	Housing number	Unit number cast dust cover type	Nominal dimensions			Mass of unit	
			mm inch			kg lb	
			t max.	H ₃	A ₅	UKP	C(CM)
UKX05D1;H2305X UKX05D1;HE2305	PX05D1 PX05D1	C(CM)-UKPX05D1;H2305X C(CM)-UKPX05ED1;HE2305	2 5/64	89 3 1/2	75 2 15/16	1.4 3.1	1.8 4.0
UKX06D1;H2306X UKX06D1;HS2306 UKX06D1;HE2306X	PX06D1 PX06D1 PX06D1	C(CM)-UKPX06D1;H2306X C(CM)-UKPX06SD1;HS2306 C(CM)-UKPX06ED1;HE2306X	2 5/64	99 3 29/32	80 3 5/32	1.7 3.7	2.2 4.9
UKX07D1;H2307X UKX07D1;HS2307	PX07D1 PX07D1	C(CM)-UKPX07D1;H2307X C(CM)-UKPX07SD1;HS2307	3 1/8	110 4 11/32	90 3 17/32	2.5 5.5	3.3 7.3
UKX08D1;H2308X UKX08D1;HE2308X UKX08D1;HS2308X	PX08D1 PX08D1 PX08D1	C(CM)-UKPX08D1;H2308X C(CM)-UKPX08ED1;HE2308X C(CM)-UKPX08SD1;HS2308X	3 1/8	118 4 41/64	95 3 3/4	3.2 7.1	4.1 9.0
UKX09D1;H2309X UKX09D1;HA2309 UKX09D1;HE2309X UKX09D1;HS2309X	PX09D1 PX09D1 PX09D1 PX09D1	C(CM)-UKPX09D1;H2309X C(CM)-UKPX09AD1;HA2309 C(CM)-UKPX09ED1;HE2309X C(CM)-UKPX09SD1;HS2309X	3 1/8	120 4 23/32	100 3 15/16	3.3 7.3	4.3 9.5
UKX10D1;H2310X UKX10D1;HS2310 UKX10D1;HA2310 UKX10D1;HE2310X	PX10D1 PX10D1 PX10D1 PX10D1	C(CM)-UKPX10D1;H2310X C(CM)-UKPX10SD1;HS2310 C(CM)-UKPX10AD1;HA2310 C(CM)-UKPX10ED1;HE2310X	3 1/8	130 5 1/8	100 3 15/16	4.2 9.3	5.4 12
UKX11D1;H2311X UKX11D1;HS2311 UKX11D1;HA2311 UKX11D1;HE2311XY	PX11D1 PX11D1 PX11D1 PX11D1	C(CM)-UKPX11D1;H2311X C(CM)-UKPX11SD1;HS2311 C(CM)-UKPX11AD1;HA2311 C(CM)-UKPX11ED1;HE2311XY	4 5/32	144 5 21/32	115 4 17/32	5.3 12	6.8 15
UKX12D1;H2312X UKX12D1;HS2312	PX12D1 PX12D1	C(CM)-UKPX12D1;H2312X C(CM)-UKPX12SD1;HS2312	4 5/32	155 6 3/32	120 4 23/32	6.8 15	8.6 19

Notes (1) These numbers indicate relubricatable type. If maintenance free type is needed, please order without suffix "D1".
(2) Adapter number with suffix "X" means a narrow slot type adapter sleeve.
In this case the lock washer with the straight inner prong should be used.
(3) For HE2311XY, screw thread pitch different from the standard is applied, because of the thin thread section of sleeve.
To distinguish it, a suffix "Y" is added.

Remarks Please refer to page A21 for size of grease fitting.

Pillow block unit, cast housing Adapter type

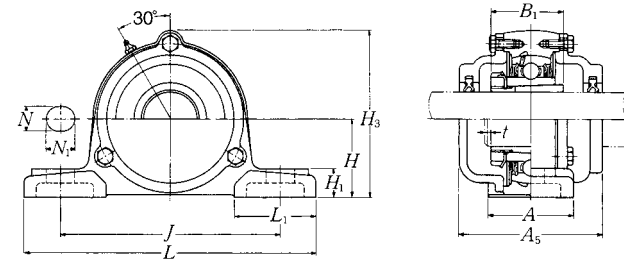
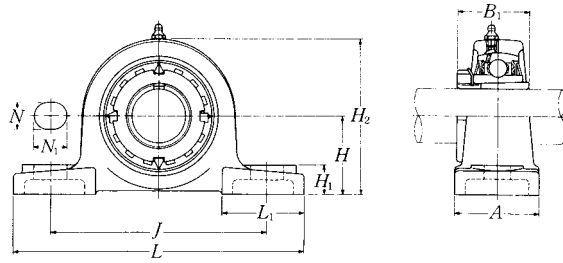

Cast dust cover type
Open end **C-UKP...D1**
Closed end **CM-UKP...D1**

Shaft dia. mm inch	Unit number ⁽¹⁾ (²)	Nominal dimensions										Bolt size mm inch
		mm inch										
		H	L	J	A	N	N ₁	H ₁	H ₂	L ₁	B ₁	
60 2 3/16 2 1/4 2 3/8	UKPX13D1;H2313X UKPX13D1;HA2313 UKPX13D1;HE2313X UKPX13D1;HS2313X	76.2	286	203	83	25	28	33	154	80	65	M20
		3	11 1/4	8	3 3/32	3 1/32	1 3/32	1 5/16	6 1/16	3 5/32	2.559	3/4
65 2 7/16 2 1/2	UKPX15D1;H2315X UKPX15D1;HA2315 UKPX15D1;HE2315X	88.9	330	229	89	27	30	35	175	95	73	M22
		3 1/2	13	9 1/32	3 1/2	1 1/16	1 3/16	1 3/8	6 7/8	3 3/4	2.874	7/8
70 2 11/16 2 3/4	UKPX16D1;H2316X UKPX16D1;HA2316 UKPX16D1;HE2316X	101.6	381	283	102	27	30	40	194	110	78	M22
		4	15	11 5/32	4 1/32	1 1/16	1 3/16	1 9/16	7 5/8	4 11/32	3.071	7/8
75 2 5/16 3	UKPX17D1;H2317X UKPX17D1;HA2317X UKPX17D1;HE2317X	101.6	381	283	102	27	30	40	200	110	82	M22
		4	15	11 5/32	4 1/32	1 1/16	1 3/16	1 9/16	7 7/8	4 1/32	3.228	7/8
80 3 3/16	UKPX18D1;H2318X UKPX18D1;HA2318X	101.6	381	283	111	27	30	40	206	110	86	M22
		4	15	11 5/32	4 3/8	1 1/16	1 3/16	1 9/16	8 1/8	4 11/32	3.386	7/8
90	UKPX20D1;H2320X	127	432	337	121	33	36	45	244	125	97	M27

Notes ⁽¹⁾ These numbers indicate relubricatable type. If maintenance free type is needed, please order without suffix "D1".

⁽²⁾ Adapter number with suffix "X" means a narrow slot type adapter sleeve.

In this case the lock washer with the straight inner prong should be used.

Remarks Please refer to page A21 for size of grease fitting.

Bearing number	Housing number	Unit number cast dust cover type	Nominal dimensions			Mass of unit	
			mm inch			kg lb	
			t max.	H ₅	A ₅	UKP	C(CM)
UKX13D1;H2313X	PX13D1	C(CM)-UKPX13D1;H2313X	4	159	135	6.9	9.2
UKX13D1;HA2313	PX13D1	C(CM)-UKPX13AD1;HA2313	5/32	6 1/4	5 5/16	15	20
UKX13D1;HE2313X	PX13D1	C(CM)-UKPX13ED1;HE2313X					
UKX13D1;HS2313X	PX13D1	C(CM)-UKPX13SD1;HS2313X					
UKX15D1;H2315X	PX15D1	C(CM)-UKPX15D1;H2315X	4	181	145	10	13
UKX15D1;HA2315	PX15D1	C(CM)-UKPX15AD1;HA2315	5/32	7 1/8	5 23/32	22	29
UKX15D1;HE2315X	PX15D1	C(CM)-UKPX15ED1;HE2315X					
UKX16D1;H2316X	PX16D1	C(CM)-UKPX16D1;H2316X	4	198	155	14	17
UKX16D1;HA2316	PX16D1	C(CM)-UKPX16AD1;HA2316	5/32	7 25/32	6 3/32	31	37
UKX16D1;HE2316X	PX16D1	C(CM)-UKPX16ED1;HE2316X					
UKX17D1;H2317X	PX17D1	C(CM)-UKPX17D1;H2317X	5	204	165	15	18
UKX17D1;HA2317X	PX17D1	C(CM)-UKPX17AD1;HA2317X	13/64	8 1/32	6 1/2	33	40
UKX17D1;HE2317X	PX17D1	C(CM)-UKPX17ED1;HE2317X					
UKX18D1;H2318X	PX18D1	C(CM)-UKPX18D1;H2318X	5	208	180	16	20
UKX18D1;HA2318X	PX18D1	C(CM)-UKPX18AD1;HA2318	13/64	8 3/16	7 3/32	35	44
UKX20D1;H2320X	PX20D1	C(CM)-UKPX20D1;H2320X					

Square flanged unit, cast housing Adapter type

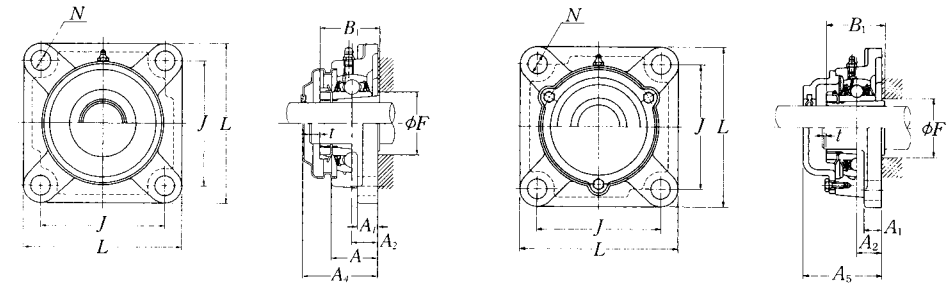
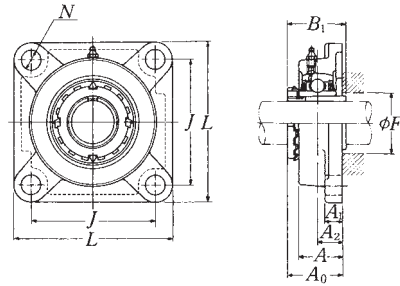

Pressed steel dust cover type
Open end **Z-UKF...D1**
Closed end **ZM-UKF...D1**

Cast dust cover type
Open end **C-UKF...D1**
Closed end **CM-UKF...D1**

Shaft dia. mm inch	Unit number ⁽¹⁾⁽²⁾⁽³⁾	Nominal dimensions									Bolt size mm inch	Bearing number
		L	J	A ₂	A ₁	mm inch A		N	A ₀	B ₁		
20 3/4	UKF205D1;H2305X	95	70	16	13	27	12	35.5	35	30	M10	UK205D1;H2305X
	UKF205D1;HE2305	3 3/4	2 3/4	5/8	1/2	1 1/16	15/32	1 25/64	1.378	1 1/16	3/8	UK205D1;HE2305
25 7/8	UKF206D1;H2306X	108	83	18	13	31	12	39	38	36	M10	UK206D1;H2306X
	UKF206D1;HS2306	4 1/4	3 17/64	45/64	1/2	1 7/32	15/32	1 17/32	1.496	1 19/32	3/8	UK206D1;HS2306
1	UKF206D1;HE2306X											UK206D1;HE2306X
30 1 1/8	UKF207D1;H2307X	117	92	19	15	34	14	42.5	43	40	M12	UK207D1;H2307X
	UKF207D1;HS2307	4 19/32	3 5/8	3/4	19/32	1 11/32	35/64	1 43/64	1.693	1 9/16	7/16	UK207D1;HS2307
35 1 1/4	UKF208D1;H2308X	130	102	21	15	36	16	46.5	46	46	M14	UK208D1;H2308X
	UKF208D1;HE2308X	5 1/8	4 1/64	53/64	19/32	1 13/32	5/8	1 53/64	1.811	1 19/16	1/2	UK208D1;HE2308X
1 3/8	UKF208D1;HS2308X											UK208D1;HS2308X
40 1 7/16	UKF209D1;H2309X	137	105	22	16	38	16	48.5	50	52	M14	UK209D1;H2309X
	UKF209D1;HA2309	5 13/32	4 9/64	55/64	5/8	1 1/2	5/8	1 29/32	1.969	2 1/16	1/2	UK209D1;HA2309
1 1/2	UKF209D1;HE2309X											UK209D1;HE2309X
	UKF209D1;HS2309X											UK209D1;HS2309X
1 5/8												
45 1 5/8	UKF210D1;H2310X	143	111	22	16	40	16	50	55	57	M14	UK210D1;H2310X
	UKF210D1;HS2310	5 5/8	4 3/8	55/64	5/8	1 9/16	5/8	1 31/32	2.165	2 1/4	1/2	UK210D1;HS2310
1 11/16	UKF210D1;HA2310											UK210D1;HA2310
	UKF210D1;HE2310X											UK210D1;HE2310X
1 3/4												
50 1 7/8	UKF211D1;H2311X	162	130	25	18	43	19	54.5	59	64	M16	UK211D1;H2311X
	UKF211D1;HS2311	6 3/8	5 1/8	63/64	23/32	1 11/16	3/4	2 9/64	2.323	2 17/32	5/8	UK211D1;HS2311
1 15/16	UKF211D1;HA2311											UK211D1;HA2311
	UKF211D1;HE2311XY											UK211D1;HE2311XY
2												
55 2 1/8	UKF212D1;H2312X	175	143	29	18	48	19	61	62	69	M16	UK212D1;H2312X
	UKF212D1;HS2312	6 7/8	5 5/8	1 9/64	23/32	1 7/8	3/4	2 13/32	2.441	2 29/32	5/8	UK212D1;HS2312

Housing number	Unit number ⁽⁴⁾ pressed steel dust cover type	Unit number ⁽⁴⁾ cast dust cover type	Nominal dimensions			Mass of unit		
			t max.	mm inch A ₄ A ₅		kg lb UKF Z(ZM) C(CM)		
F205D1	Z(ZM)-UKF205D1;H2305X	C(CM)-UKF205D1;H2305X	2	40	51	0.8	0.8	1.0
F205D1	Z(ZM)-UKF205ED1;HE2305	C(CM)-UKF205ED1;HE2305	5/64	1 19/32	2	1.8	1.8	2.2
F206D1	Z(ZM)-UKF206D1;H2306X	C(CM)-UKF206D1;H2306X	2	45	56	1.1	1.1	1.3
F206D1	Z(ZM)-UKF206SD1;HS2306	C(CM)-UKF206SD1;HS2306	5/64	1 3/4	2 7/32	2.4	2.4	2.9
F206D1	Z(ZM)-UKF206ED1;HE2306X	C(CM)-UKF206ED1;HE2306X						
F207D1	Z(ZM)-UKF207D1;H2307X	C(CM)-UKF207D1;H2307X	3	49	59	1.6	1.6	1.9
F207D1	Z(ZM)-UKF207SD1;HS2307	C(CM)-UKF207SD1;HS2307	1/8	1 15/16	2 5/16	3.5	3.5	4.2
F208D1	Z(ZM)-UKF208D1;H2308X	C(CM)-UKF208D1;H2308X	3	56	66	1.8	1.9	2.4
F208D1	Z(ZM)-UKF208ED1;HE2308X	C(CM)-UKF208ED1;HE2308X	1/8	2 3/16	2 19/32	4.0	4.2	5.3
F208D1	Z(ZM)-UKF208SD1;HS2308X	C(CM)-UKF208SD1;HS2308X						
F209D1	Z(ZM)-UKF209D1;H2309X	C(CM)-UKF209D1;H2309X	3	57	70	2.3	2.3	2.8
F209D1	Z(ZM)-UKF209AD1;HA2309	C(CM)-UKF209AD1;HA2309						
F209D1	Z(ZM)-UKF209ED1;HE2309X	C(CM)-UKF209ED1;HE2309X	1/8	2 1/4	2 3/4	5.1	5.1	6.2
F209D1	Z(ZM)-UKF209SD1;HS2309X	C(CM)-UKF209SD1;HS2309X						
F210D1	Z(ZM)-UKF210D1;H2310X	C(CM)-UKF210D1;H2310X	3	60	72	2.6	2.7	3.2
F210D1	Z(ZM)-UKF210SD1;HS2310	C(CM)-UKF210SD1;HS2310						
F210D1	Z(ZM)-UKF210AD1;HA2310	C(CM)-UKF210AD1;HA2310	1/8	2 3/8	2 27/32	5.7	6.0	7.1
F210D1	Z(ZM)-UKF210ED1;HE2310X	C(CM)-UKF210ED1;HE2310X						
F211D1	Z(ZM)-UKF211D1;H2311X	C(CM)-UKF211D1;H2311X	4	64	75	3.5	3.6	4.3
F211D1	Z(ZM)-UKF211SD1;HS2311	C(CM)-UKF211SD1;HS2311						
F211D1	Z(ZM)-UKF211AD1;HA2311	C(CM)-UKF211AD1;HA2311	5/32	2 1/2	2 15/16	7.7	7.9	9.5
F211D1	Z(ZM)-UKF211ED1;HE2311XY	C(CM)-UKF211ED1;HE2311XY						
F212D1	Z(ZM)-UKF212D1;H2312X	C(CM)-UKF212D1;H2312X	4	74	86	4.0	4.2	5.0
F212D1	Z(ZM)-UKF212SD1;HS2312	C(CM)-UKF212SD1;HS2312	5/32	2 29/32	3 3/8	8.8	9.3	11

Notes ⁽¹⁾ These numbers indicate relubricatable type. If maintenance free type is needed, please order without suffix "D1".
⁽²⁾ Adapter number with suffix "X" means a narrow slot type adapter sleeve.
 In this case the lock washer with the straight inner prong should be used.
⁽³⁾ For HE2311XY, screw thread pitch different from the standard is applied, because of the thin thread section of sleeve.
 To distinguish it, a suffix "Y" is added.
⁽⁴⁾ If the inch series housing units with dust cover are ordered with a closed end, the suffixes E, S or A are not included.
 Example: ZM-UKF205D1;HE2305

Square flanged unit, cast housing Adapter type

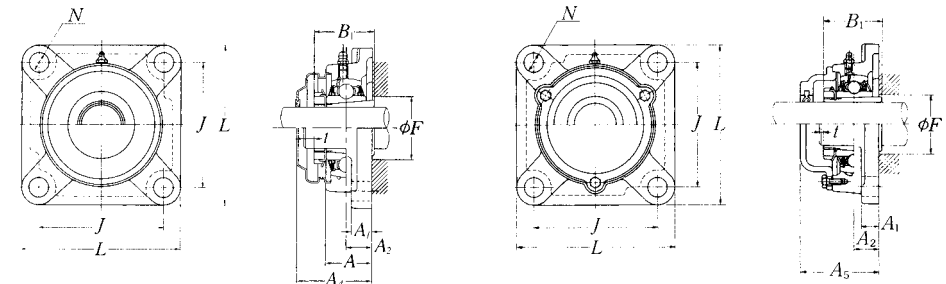
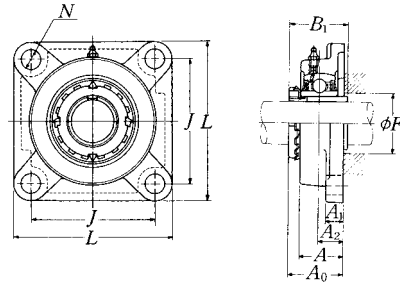

Pressed steel dust cover type
Open end **Z-UKF...D1**
Closed end **ZM-UKF...D1**

Cast dust cover type
Open end **C-UKF...D1**
Closed end **CM-UKF...D1**

Shaft dia. mm inch	Unit number ⁽¹⁾ (²)	Nominal dimensions									Bolt size mm inch	Bearing number
		L	J	A ₂	A ₁	A	N	A ₀	B ₁	F		
60 2 3/16 2 1/4 2 3/8	UKF213D1;H2313X UKF213D1;HA2313 UKF213D1;HE2313X UKF213D1;HS2313X	187	149	30	22	50	19	64	65	74	M16	UK213D1;H2313X UK213D1;HA2313 UK213D1;HE2313X UK213D1;HS2313X
		7 3/8	5 55/64	1 3/16	7/8	1 31/32	3/4	2 33/64	2.559	2 29/32	5/8	
65 2 7/16 2 1/2	UKF215D1;H2315X UKF215D1;HA2315 UKF215D1;HE2315X	200	159	34	22	56	19	71	73	84	M16	UK215D1;H2315X UK215D1;HA2315 UK215D1;HE2315X
		7 7/8	6 17/64	1 11/32	7/8	2 7/32	3/4	2 51/64	2.874	3 5/16	5/8	
70 2 11/16 2 3/4	UKF216D1;H2316X UKF216D1;HA2316 UKF216D1;HE2316X	208	165	34	22	58	23	73.5	78	90	M20	UK216D1;H2316X UK216D1;HA2316 UK216D1;HE2316X
		8 3/16	6 1/2	1 11/32	7/8	2 9/32	29/32	2 57/64	3.071	3 17/32	3/4	
75 2 15/16 3	UKF217D1;H2317X UKF217D1;HA2317X UKF217D1;HE2317X	220	175	36	24	63	23	77	82	95	M20	UK217D1;H2317X UK217D1;HA2317X UK217D1;HE2317X
		8 21/32	6 57/64	1 27/64	15/16	2 15/32	29/32	3 1/32	3.228	3 3/4	3/4	
80 3 3/16	UKF218D1;H2318X UKF218D1;HA2318X	235	187	40	24	68	23	81.5	86	102	M20	UK218D1;H2318X UK218D1;HA2318X
		9 1/4	7 23/64	1 37/64	15/16	2 11/16	29/32	3 13/64	3.386	4 1/32	3/4	

Housing number	Unit number ⁽²⁾ pressed steel dust cover type	Unit number ⁽²⁾ cast dust cover type	Nominal dimensions			Mass of unit		
			t max.	A ₄	A ₅	UKF	Z(ZM)	C(CM)
F213D1	Z(ZM)-UKF213D1;H2313X	C(CM)-UKF213D1;H2313X	4	76	90	5.6	5.8	6.7
F213D1	Z(ZM)-UKF213AD1;HA2313	C(CM)-UKF213AD1;HA2313	5/32	3	3 17/32	12	13	15
F213D1	Z(ZM)-UKF213ED1;HE2313X	C(CM)-UKF213ED1;HE2313X						
F213D1	Z(ZM)-UKF213SD1;HS2313X	C(CM)-UKF213SD1;HS2313X						
F215D1	—	C(CM)-UKF215D1;H2315X	4	—	102	6.8	—	8.3
F215D1	—	C(CM)-UKF215AD1;HA2315	5/32	—	4 1/32	15	—	18
F215D1	—	C(CM)-UKF215ED1;HE2315X						
F216D1	—	C(CM)-UKF216D1;H2316X	4	—	106	8.3	—	10
F216D1	—	C(CM)-UKF216AD1;HA2316	5/32	—	4 3/16	18	—	22
F216D1	—	C(CM)-UKF216ED1;HE2316X						
F217D1	—	C(CM)-UKF217D1;H2317X	5	—	114	10	—	13
F217D1	—	C(CM)-UKF217AD1;HA2317X	13/64	—	4 1/2	22	—	29
F217D1	—	C(CM)-UKF217ED1;HE2317X						
F218D1	—	C(CM)-UKF218D1;H2318X	5	—	122	12	—	14
F218D1	—	C(CM)-UKF218AD1;HA2318X	13/64	—	4 13/16	26	—	31

- Notes** ⁽¹⁾ These numbers indicate relubricatable type. If maintenance free type is needed, please order without suffix "D1".
⁽²⁾ Adapter number with suffix "X" means a narrow slot type adapter sleeve. In this case the lock washer with the straight inner prong should be used.
⁽³⁾ If the inch series housing units with dust cover are ordered with a closed end, the suffixes E, S or A are not included. Example: ZM-UKF205D1;HE2305

Remarks Please refer to page A21 for size of grease fitting.

Square flanged unit, cast housing Adapter type

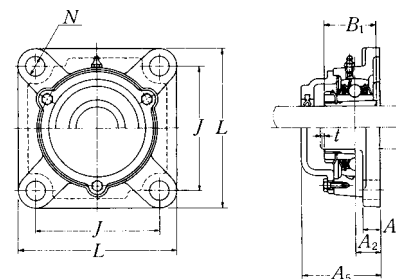
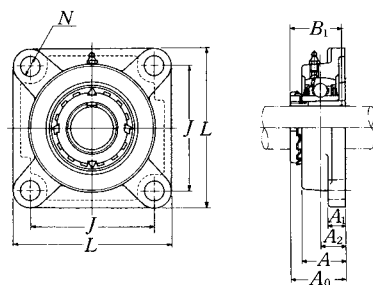

Cast dust cover type
Open end **C-UKF...D1**
Closed end **CM-UKF...D1**

Shaft dia. mm inch	Unit number ⁽¹⁾⁽²⁾⁽³⁾	Nominal dimensions								Bolt size mm inch
		mm inch								
		L	J	A ₂	A ₁	A	N	A ₀	B ₁	
20 3/4	UKF305D1;H2305X UKF305D1;HE2305	110 4 11/32	80 3 5/32	16 5/8	13 1/2	29 1 5/32	16 5/8	37 1 29/64	35 1.378	M14 1/2
25 7/8	UKF306D1;H2306X UKF306D1;HS2306 UKF306D1;HE2306X	125 4 29/32	95 3 47/64	18 45/64	15 19/32	32 1 1/4	16 5/8	40.5 1 19/32	38 1.496	M14 1/2
30 1 1/8	UKF307D1;H2307X UKF307D1;HS2307	135 5 5/16	100 3 15/16	20 25/32	16 5/8	36 1 13/32	19 3/4	45.5 1 51/64	43 1.693	M16 5/8
35 1 1/4 1 3/8	UKF308D1;H2308X UKF308D1;HE2308X UKF308D1;HS2308X	150 5 29/32	112 4 13/32	23 29/32	17 21/32	40 1 9/16	19 3/4	50 1 31/32	46 1.811	M16 5/8
40 1 7/16 1 1/2 1 5/8	UKF309D1;H2309X UKF309D1;HA2309 UKF309D1;HE2309X UKF309D1;HS2309X	160 6 5/16	125 4 59/64	25 63/64	18 23/32	44 1 23/32	19 3/4	54.5 2 9/64	50 1.969	M16 5/8
45 1 5/8 1 15/16 1 3/4	UKF310D1;H2310X UKF310D1;HS2310 UKF310D1;HA2310 UKF310D1;HE2310X	175 6 7/8	132 5 13/64	28 1 7/64	19 3/4	48 1 7/8	23 29/32	60.5 2 3/8	55 2.165	M20 3/4
50 1 7/8 1 15/16 2	UKF311D1;H2311X UKF311D1;HS2311 UKF311D1;HA2311 UKF311D1;HE2311XY	185 7 9/32	140 5 33/64	30 1 3/16	20 25/32	52 2 1/16	23 29/32	64 2 33/64	59 2.323	M20 3/4
55 2 1/8	UKF312D1;H2312X UKF312D1;HS2312	195 7 11/16	150 5 29/32	33 1 19/64	22 7/8	56 2 7/32	23 29/32	69.5 2 47/64	62 2.441	M20 3/4

Bearing number	Housing number	Unit number ⁽⁴⁾ cast dust cover type	Nominal dimensions		Mass of unit	
			mm inch		kg lb	
			t max.	A ₅	UKF	C(CM)
UK305D1;H2305X UK305D1;HE2305	F305D1 F305D1	C(CM)-UKF305D1;H2305X C(CM)-UKF305ED1;HE2305	2 5/64	56 2 7/32	1.1 2.4	1.5 3.3
UK306D1;H2306X UK306D1;HS2306 UK306D1;HE2306X	F306D1 F306D1 F306D1	C(CM)-UKF306D1;H2306X C(CM)-UKF306SD1;HS2306 C(CM)-UKF306ED1;HE2306X	2 5/64	60 2 3/8	1.7 3.7	2.1 4.6
UK307D1;H2307X UK307D1;HS2307	F307D1 F307D1	C(CM)-UKF307D1;H2307X C(CM)-UKF307SD1;HS2307	3 1/8	68 2 11/16	2.1 4.6	2.7 6.0
UK308D1;H2308X UK308D1;HE2308X UK308D1;HS2308X	F308D1 F308D1 F308D1	C(CM)-UKF308D1;H2308X C(CM)-UKF308ED1;HE2308X C(CM)-UKF308SD1;HS2308X	3 1/8	76 3	2.8 6.2	3.5 7.7
UK309D1;H2309X UK309D1;HA2309 UK309D1;HE2309X UK309D1;HS2309X	F309D1 F309D1 F309D1 F309D1	C(CM)-UKF309D1;H2309X C(CM)-UKF309AD1;HA2309 C(CM)-UKF309ED1;HE2309X C(CM)-UKF309SD1;HS2309X	3 1/8	80 3 5/32	3.4 7.5	4.4 9.7
UK310D1;H2310X UK310D1;HS2310 UK310D1;HA2310 UK310D1;HE2310X	F310D1 F310D1 F310D1 F310D1	C(CM)-UKF310D1;H2310X C(CM)-UKF310SD1;HS2310 C(CM)-UKF310AD1;HA2310 C(CM)-UKF310ED1;HE2310X	3 1/8	88 3 15/32	4.5 9.9	5.9 13
UK311D1;H2311X UK311D1;HS2311 UK311D1;HA2311 UK311D1;HE2311XY	F311D1 F311D1 F311D1 F311D1	C(CM)-UKF311D1;H2311X C(CM)-UKF311SD1;HS2311 C(CM)-UKF311AD1;HA2311 C(CM)-UKF311ED1;HE2311XY	4 5/32	92 3 5/8	5.3 12	6.8 15
UK312D1;H2312X UK312D1;HS2312	F312D1 F312D1	C(CM)-UKF312D1;H2312X C(CM)-UKF312SD1;HS2312	4 5/32	100 3 15/16	6.3 14	7.9 17

- Notes** (1) These numbers indicate relubricatable type. If maintenance free type is needed, please order without suffix "D1".
 (2) Adapter number with suffix "X" means a narrow slot type adapter sleeve.
 In this case the lock washer with the straight inner prong should be used.
 (3) For HE2311XY, screw thread pitch different from the standard is applied, because of the thin thread section of sleeve.
 To distinguish it, a suffix "Y" is added.
 (4) If the inch series housing units with dust cover are ordered with a closed end, the suffixes E, S or A are not included.
 Example: CM-UKF305D1;HE2305

Remarks Please refer to page A21 for size of grease fitting.

B264

B265

Square flanged unit, cast housing Adapter type

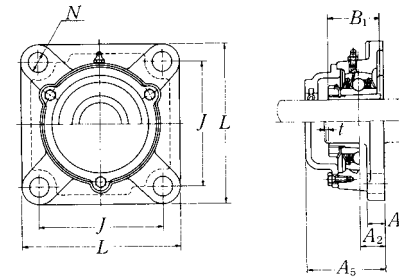
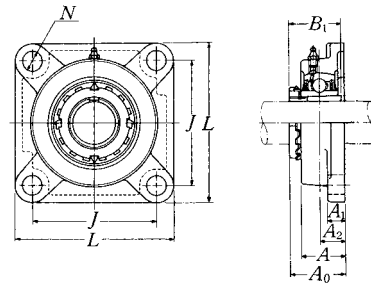

Cast dust cover type
Open end **C-UKF...D1**
Closed end **CM-UKF...D1**

Shaft dia. mm inch	Unit number ⁽¹⁾ (²)	Nominal dimensions									Bolt size mm inch
		mm inch									
		L	J	A ₂	A ₁	A	N	A ₀	B ₁		
60 2 3/16 2 1/4 2 3/8	UKF313D1;H2313X UKF313D1;HA2313 UKF313D1;HE2313X UKF313D1;HS2313X	208 8 5/16	166 6 17/32	33 1 19/64	22 7/8	58 2 9/32	23 29/32	71.5 2 13/16	65 2.559	M20 3/4	
65 2 7/16 2 1/2	UKF315D1;H2315X UKF315D1;HA2315 UKF315D1;HE2315X	236 9 9/32	184 7 1/4	39 1 17/32	25 31/32	66 2 19/32	25 63/64	81.5 3 13/64	73 2.874	M22 7/8	
70 2 11/16 2 3/4	UKF316D1;H2316X UKF316D1;HA2316 UKF316D1;HE2316X	250 9 27/32	196 7 23/32	38 1 1/2	27 1 1/16	68 2 11/16	31 1 7/32	84 3 5/16	78 3.071	M27 1	
75 2 15/16 3	UKF317D1;H2317X UKF317D1;HA2317X UKF317D1;HE2317X	260 10 1/4	204 8 1/32	44 1 47/64	27 1 1/16	74 2 29/32	31 1 7/32	92 3 5/8	82 3.228	M27 1	
80 3 13/16	UKF318D1;H2318X UKF318D1;HA2318X	280 11 1/32	216 8 1/2	44 1 47/64	30 1 3/16	76 3	35 1 3/8	94 3 45/64	86 3.386	M30 1 1/8	
85 3 3/4	UKF319D1;H2319X UKF319D1;HE2319X	290 11 19/32	228 8 21/32	59 2 21/64	30 1 3/16	94 3 11/16	35 1 3/8	111.5 4 25/64	90 3.543	M30 1 1/8	
90 3 7/16 3 1/2	UKF320D1;H2320X UKF320D1;HA2320 UKF320D1;HE2320X	310 12 7/32	242 9 17/32	59 2 21/64	32 1 1/4	94 3 11/16	38 1 1/2	115.5 4 35/64	97 3.819	M33 1 1/4	
100	UKF322D1;H2322X	340	266	60	35	96	41	121	105	M36	
110	UKF324D1;H2324	370	290	65	40	110	41	130	112	M36	
115	UKF326D1;H2326	410	320	65	45	115	41	133	121	M36	
125	UKF328D1;H2328	450	350	75	55	125	41	146.5	131	M36	

Notes ⁽¹⁾ These numbers indicate relubricatable type. If maintenance free type is needed, please order without suffix "D1".

⁽²⁾ Adapter number with suffix "X" means a narrow slot type adapter sleeve. In this case the lock washer with the straight inner prong should be used.

⁽³⁾ If the inch series housing units with dust cover are ordered with a closed end, the suffixes E, S or A are not included. Example: CM-UKF305D1;HE2305

Remarks Please refer to page A21 for size of grease fitting.

Bearing number	Housing number	Unit number ⁽³⁾ cast dust cover type	Nominal dimensions		Mass of unit	
			mm inch		kg lb	
			t max.	A ₅	UKF	C(CM)
UK313D1;H2313X UK313D1;HA2313 UK313D1;HE2313X UK313D1;HS2313X	F313D1 F313D1 F313D1 F313D1	C(CM)-UKF313D1;H2313X C(CM)-UKF313AD1;HA2313 C(CM)-UKF313ED1;HE2313X C(CM)-UKF313SD1;HS2313X	4 5/32	103 4 1/16	7.8 17	9.6 21
UK315D1;H2315X UK315D1;HA2315 UK315D1;HE2315X	F315D1 F315D1 F315D1	C(CM)-UKF315D1;H2315X C(CM)-UKF315AD1;HA2315 C(CM)-UKF315ED1;HE2315X	4 5/32	114 4 1/2	11 24	13 29
UK316D1;H2316X UK316D1;HA2316 UK316D1;HE2316X	F316D1 F316D1 F316D1	C(CM)-UKF316D1;H2316X C(CM)-UKF316AD1;HA2316 C(CM)-UKF316ED1;HE2316X	4 5/32	116 4 9/16	14 31	16 35
UK317D1;H2317X UK317D1;HA2317X UK317D1;HE2317X	F317D1 F317D1 F317D1	C(CM)-UKF317D1;H2317X C(CM)-UKF317AD1;HA2317X C(CM)-UKF317ED1;HE2317X	5 13/64	129 5 3/32	15 33	19 42
UK318D1;H2318X UK318D1;HA2318X	F318D1 F318D1	C(CM)-UKF318D1;H2318X C(CM)-UKF318AD1;HA2318X	5 13/64	129 5 3/32	19 42	23 51
UK319D1;H2319X UK319D1;HE2319X	F319D1 F319D1	C(CM)-UKF319D1;H2319X C(CM)-UKF319ED1;HE2319X	5 13/64	149 5 7/8	22 49	26 57
UK320D1;H2320X UK320D1;HA2320 UK320D1;HE2320X	F320D1 F320D1 F320D1	C(CM)-UKF320D1;H2320X C(CM)-UKF320AD1;HA2320 C(CM)-UKF320ED1;HE2320X	5 13/64	154 6 1/16	27 60	32 71
UK322D1;H2322X	F322D1	C(CM)-UKF322D1;H2322X	5	160	35	41
UK324D1;H2324	F324D1	C(CM)-UKF324D1;H2324	5	172	48	56
UK326D1;H2326	F326D1	C(CM)-UKF326D1;H2326	6	178	63	75
UK328D1;H2328	F328D1	C(CM)-UKF328D1;H2328	6	192	90	101

Square flanged unit, cast housing Adapter type

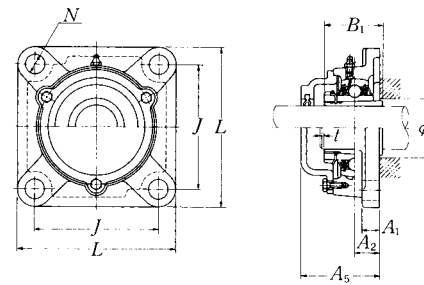
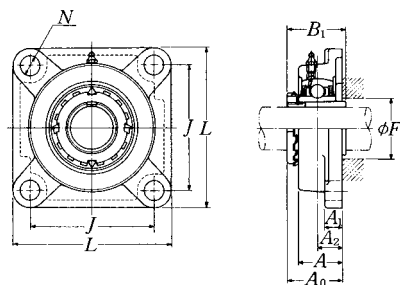

Cast dust cover type
Open end **C-UKF...D1**
Closed end **CM-UKF...D1**

Shaft dia. mm inch	Unit number ⁽¹⁾ / ₍₂₎ / ₍₃₎	Nominal dimensions										Bolt size mm inch
		L	J	A ₂	A ₁	mm inch		A	N	A ₀	B ₁	
20 3/4	UKFX05D1;H2305X UKFX05D1;HE2305	108 4 1/4	83 3 17/64	18 45/64	13 1/2	30 1 3/16	12 15/32	39 1 17/32	35	1.378	-	M10 3/8
25 7/8 1	UKFX06D1;H2306X UKFX06D1;HS2306 UKFX06D1;HE2306X	117 4 19/32	92 3 5/8	19 3/4	14 9/16	34 1 11/32	16 5/8	41.5 1 41/64	38	1.496	-	M14 1/2
30 1 1/8	UKFX07D1;H2307X UKFX07D1;HS2307	130 5 1/8	102 4 1/64	21 53/64	14 9/16	38 1 1/2	16 5/8	45.5 1 51/64	43	1.693	-	M14 1/2
35 1 1/4 1 3/8	UKFX08D1;H2308X UKFX08D1;HE2308X UKFX08D1;HS2308X	137 5 13/32	105 4 9/64	22 55/64	14 9/16	40 1 9/16	19 3/4	47.5 1 7/8	46	1.811	46 1 13/16	M16 5/8
40 1 7/16 1 1/2 1 5/8	UKFX09D1;H2309X UKFX09D1;HA2309 UKFX09D1;HE2309X UKFX09D1;HS2309X	143 5 5/8	111 4 3/8	23 29/32	14 9/16	40 1 9/16	19 3/4	50 1 31/32	50	1.969	52 2 1/16	M16 5/8
45 1 5/8 1 11/16 1 3/4	UKFX10D1;H2310X UKFX10D1;HS2310 UKFX10D1;HA2310 UKFX10D1;HE2310X	162 6 3/8	130 5 1/8	26 1 1/32	20 25/32	44 1 23/32	19 3/4	55.5 2 3/16	55	2.165	57 2 1/4	M16 5/8
50 1 7/8 1 13/16 2	UKFX11D1;H2311X UKFX11D1;HS2311 UKFX11D1;HA2311 UKFX11D1;HE2311XY	175 6 7/8	143 5 5/8	29 1 9/64	20 25/32	49 1 15/16	19 3/4	60 2 23/64	59	2.323	64 2 17/32	M16 5/8
55 2 1/8	UKFX12D1;H2312X UKFX12D1;HS2312	187 7 3/8	149 5 55/64	34 1 11/32	21 13/16	59 2 5/16	19 3/4	67 2 21/64	62	2.441	-	M16 5/8

Bearing number	Housing number	Unit number ⁽⁴⁾ cast dust cover type	Nominal dimensions		Mass of unit	
			t max.	A ₅	UKF	C(CM)
UKX05D1;H2305X UKX05D1;HE2305	FX05D1 FX05D1	C(CM)-UKFX05D1;H2305X C(CM)-UKFX05ED1;HE2305	2 5/64	56 2 7/32	1.1 2.4	1.3 2.9
UKX06D1;H2306X UKX06D1;HS2306 UKX06D1;HE2306X	FX06D1 FX06D1 FX06D1	C(CM)-UKFX06D1;H2306X C(CM)-UKFX06SD1;HS2306 C(CM)-UKFX06ED1;HE2306X	2 5/64	59 2 5/16	1.6 3.5	1.8 4.0
UKX07D1;H2307X UKX07D1;HS2307	FX07D1 FX07D1	C(CM)-UKFX07D1;H2307X C(CM)-UKFX07SD1;HS2307	3 1/8	66 2 9/32	2.1 4.6	2.5 5.5
UKX08D1;H2308X UKX08D1;HE2308X UKX08D1;HS2308X	FX08D1 FX08D1 FX08D1	C(CM)-UKFX08D1;H2308X C(CM)-UKFX08ED1;HE2308X C(CM)-UKFX08SD1;HS2308X	3 1/8	70 2 3/4	2.5 5.5	2.9 6.4
UKX09D1;H2309X UKX09D1;HA2309 UKX09D1;HE2309X UKX09D1;HS2309X	FX09D1 FX09D1 FX09D1 FX09D1	C(CM)-UKFX09D1;H2309X C(CM)-UKFX09AD1;HA2309 C(CM)-UKFX09ED1;HE2309X C(CM)-UKFX09SD1;HS2309X	3 1/8	73 2 7/8	2.5 5.5	3.0 6.6
UKX10D1;H2310X UKX10D1;HS2310 UKX10D1;HA2310 UKX10D1;HE2310X	FX10D1 FX10D1 FX10D1 FX10D1	C(CM)-UKFX10D1;H2310X C(CM)-UKFX10SD1;HS2310 C(CM)-UKFX10AD1;HA2310 C(CM)-UKFX10ED1;HE2310X	3 1/8	76 3	3.8 8.4	4.4 9.7
UKX11D1;H2311X UKX11D1;HS2311 UKX11D1;HA2311 UKX11D1;HE2311XY	FX11D1 FX11D1 FX11D1 FX11D1	C(CM)-UKFX11D1;H2311X C(CM)-UKFX11SD1;HS2311 C(CM)-UKFX11AD1;HA2311 C(CM)-UKFX11ED1;HE2311XY	4 5/32	86 3 3/8	4.7 10	5.4 12
UKX12D1;H2312X UKX12D1;HS2312	FX12D1 FX12D1	C(CM)-UKFX12D1;H2312X C(CM)-UKFX12SD1;HS2312	4 5/32	94 3 31/32	6.4 14	7.2 16

Notes ⁽¹⁾ These numbers indicate relubricatable type. If maintenance free type is needed, please order without suffix "D1".
⁽²⁾ Adapter number with suffix "X" means a narrow slot type adapter sleeve. In this case the lock washer with the straight inner prong should be used.
⁽³⁾ For HE2311XY, screw thread pitch different from the standard is applied, because of the thin thread section of sleeve. To distinguish it, a suffix "Y" is added.
⁽⁴⁾ If the inch series housing units with dust cover are ordered with a closed end, the suffixes E, S or A are not included. Example: CM-UKFX05D1;HE2305

Remarks Please refer to page A21 for size of grease fitting.

Square flanged unit, cast housing Adapter type

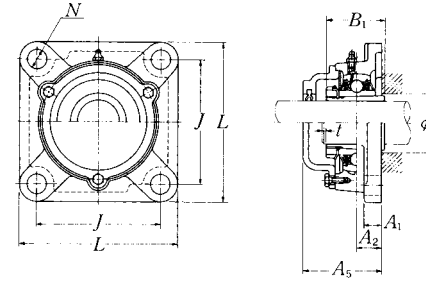
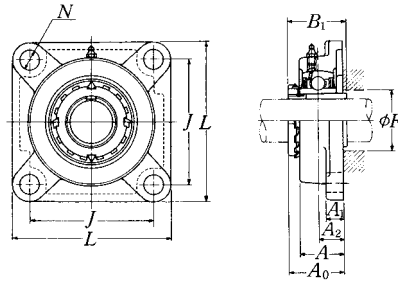

Cast dust cover type
Open end **C-UKF...D1**
Closed end **CM-UKF...D1**

Shaft dia. mm inch	Unit number ⁽¹⁾⁽²⁾	Nominal dimensions									Bolt size mm inch
		L	J	A ₂	A ₁	A	N	A ₀	B ₁	F min.	
60 2 3/16 2 1/4 2 3/8	UKFX13D1;H2313X UKFX13D1;HA2313 UKFX13D1;HE2313X UKFX13D1;HS2313X	187	149	34	21	59	19	69	65	-	M16
		7 3/8	5 5/64	1 11/32	1 9/16	2 5/16	3/4	2 29/32	2.559	-	5/8
65 2 7/16 2 1/2	UKFX15D1;H2315X UKFX15D1;HA2315 UKFX15D1;HE2315X	197	152	40	24	68	23	77.5	73	-	M20
		7 3/4	5 63/64	1 37/64	1 5/16	2 11/16	2 9/32	3 3/64	2.874	-	3/4
70 2 11/16 2 3/4	UKFX16D1;H2316X UKFX16D1;HA2316 UKFX16D1;HE2316X	214	171	40	24	70	23	80	78	90	M20
		8 7/16	6 47/64	1 37/64	1 5/16	2 3/4	2 9/32	3 5/32	3.071	3 17/32	3/4
75 2 15/16 3	UKFX17D1;H2317X UKFX17D1;HA2317X UKFX17D1;HE2317X	214	171	40	24	70	23	81.5	82	95	M20
		8 7/16	6 47/64	1 37/64	1 5/16	2 3/4	2 9/32	3 13/64	3.228	3 3/4	3/4
80 3 3/16	UKFX18D1;H2318X UKFX18D1;HA2318X	214	171	45	24	76	23	87.5	86	102	M20
		8 7/16	6 47/64	1 49/64	1 5/16	3	2 9/32	3 7/16	3.386	4 1/32	3/4
90	UKFX20D1;H2320X	268	211	59	31	97	31	107.5	97	-	M27

Notes (1) These numbers indicate relubricatable type. If maintenance free type is needed, please order without suffix "D1".
(2) Adapter number with suffix "X" means a narrow slot type adapter sleeve. In this case the lock washer with the straight inner prong should be used.
(3) If the inch series housing units with dust cover are ordered with a closed end, the suffixes E, S or A are not included. Example: CM-UKFX05D1;HE2305

Remarks Please refer to page A21 for size of grease fitting.

Bearing number	Housing number	Unit number ⁽³⁾ cast dust cover type	Nominal dimensions		Mass of unit	
			t max.	A ₅	UKF	C(CM)
UKX13D1;H2313X UKX13D1;HA2313 UKX13D1;HE2313X UKX13D1;HS2313X	FX13D1 FX13D1 FX13D1 FX13D1	C(CM)-UKFX13D1;H2313X C(CM)-UKFX13AD1;HA2313 C(CM)-UKFX13ED1;HE2313X C(CM)-UKFX13SD1;HS2313X	4 5/32	101 3 31/32	6.4 14	7.6 17
UKX15D1;H2315X UKX15D1;HA2315 UKX15D1;HE2315X	FX15D1 FX15D1 FX15D1	C(CM)-UKFX15D1;H2315X C(CM)-UKFX15AD1;HA2315 C(CM)-UKFX15ED1;HE2315X	4 5/32	112 4 13/32	8.7 19	10 22
UKX16D1;H2316X UKX16D1;HA2316 UKX16D1;HE2316X	FX16D1 FX16D1 FX16D1	C(CM)-UKFX16D1;H2316X C(CM)-UKFX16AD1;HA2316 C(CM)-UKFX16ED1;HE2316X	4 5/32	118 4 21/32	11 24	12 26
UKX17D1;H2317X UKX17D1;HA2317X UKX17D1;HE2317X	FX17D1 FX17D1 FX17D1	C(CM)-UKFX17D1;H2317X C(CM)-UKFX17AD1;HA2317X C(CM)-UKFX17ED1;HE2317X	5 13/64	122 4 13/16	12 26	14 31
UKX18D1;H2318X UKX18D1;HA2318X	FX18D1 FX18D1	C(CM)-UKFX18D1;H2318X C(CM)-UKFX18AD1;HA2318	5 13/64	135 5 5/16	12 26	14 31
UKX20D1;H2320X	FX20D1	C(CM)-UKFX20D1;H2320X	5	146.5	20	22

Square flanged unit, cast housing with spigot joint Adapter type

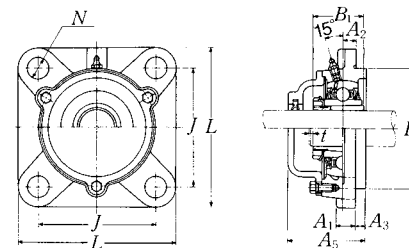
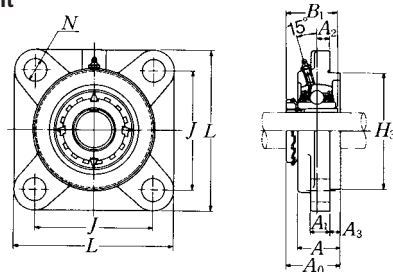

Cast dust cover type
Open end **C-UKFS...D1**
Closed end **CM-UKFS...D1**

Shaft dia. mm inch	Unit number ⁽¹⁾ / ₍₂₎	Nominal dimensions										Bolt size mm inch
		mm inch										
		L	J	A ₂	N	A ₃	A ₁	A	H ₃	A ₀	B ₁	
20 3/4	UKFS305D1;H2305X UKFS305D1;HE2305	110 4 11/32	80 3 5/32	9 23/64	16 5/8	7 9/32	13 1/2	29 1 9/64	80 3.1496	37 1 29/64	35 1.378	M14 1/2
25 7/8 1	UKFS306D1;H2306X UKFS306D1;HS2306 UKFS306D1;HE2306X	125 4 29/32	95 3 47/64	10 25/64	16 5/8	8 5/16	15 19/32	32 1 17/64	90 3.5433	40.5 1 19/32	38 1.496	M14 1/2
30 1 1/8	UKFS307D1;H2307X UKFS307D1;HS2307	135 5 5/16	100 3 15/16	11 7/16	19 3/4	9 23/64	16 5/8	36 1 13/32	100 3.9370	45.5 1 51/64	43 1.693	M16 5/8
35 1 1/4 1 3/8	UKFS308D1;H2308X UKFS308D1;HE2308X UKFS308D1;HS2308X	150 5 29/32	112 4 13/32	13 33/64	19 3/4	10 25/64	17 21/32	40 1 9/16	115 4.5276	50 1 31/32	46 1.811	M16 5/8
40 1 7/16 1 1/2 1 5/8	UKFS309D1;H2309X UKFS309D1;HA2309 UKFS309D1;HE2309X UKFS309D1;HS2309X	160 6 5/16	125 4 59/64	14 35/64	19 3/4	11 7/16	18 23/32	44 1 47/64	125 4.9213	54.5 2 9/64	50 1.969	M16 5/8
45 1 5/8 1 11/16 1 3/4	UKFS310D1;H2310X UKFS310D1;HS2310 UKFS310D1;HA2310 UKFS310D1;HE2310X	175 6 7/8	132 5 13/64	16 5/8	23 29/32	12 15/32	19 3/4	48 1 57/64	140 5.5118	60.5 2 3/8	55 2.165	M20 3/4
50 1 7/8 1 13/16 2	UKFS311D1;H2311X UKFS311D1;HS2311 UKFS311D1;HA2311 UKFS311D1;HE2311XY	185 7 9/32	140 5 33/64	17 43/64	23 29/32	13 33/64	20 25/32	52 2 3/64	150 5.9055	64 2 33/64	59 2.323	M20 3/4
55 2 1/8	UKFS312D1;H2312X UKFS312D1;HS2312	195 7 11/16	150 5 29/32	19 3/4	23 29/32	14 35/64	22 7/8	56 2 13/64	160 6.2992	69.5 2 47/64	62 2.441	M20 3/4

Notes (1) These numbers indicate relubricatable type. If maintenance free type is needed, please order without suffix "D1".
(2) Adapter number with suffix "X" means a narrow slot type adapter sleeve. In this case the lock washer with the straight inner prong should be used.
(3) For HE2311XY, screw thread pitch different from the standard is applied, because of the thin thread section of sleeve. To distinguish it, a suffix "Y" is added.
(4) If the inch series housing units with dust cover are ordered with a closed end, the suffixes E, S or A are not included. Example: CM-UKFS305D1;HE2305

Remarks Please refer to page A21 for size of grease fitting.

Bearing number	Housing number	Unit number ⁽⁴⁾ cast dust cover type	Nominal dimensions		Mass of unit	
			t mm max.	A ₅ inch	UKFS	C(CM) kg lb
UK305D1;H2305X UK305D1;HE2305	FS305D1 FS305D1	C(CM)-UKFS305D1;H2305X C(CM)-UKFS305ED1;HE2305	2 5/64	56 2 13/64	1.2 2.6	1.5 3.3
UK306D1;H2306X UK306D1;HS2306 UK306D1;HE2306X	FS306D1 FS306D1 FS306D1	C(CM)-UKFS306D1;H2306X C(CM)-UKFS306SD1;HS2306 C(CM)-UKFS306ED1;HE2306X	2 5/64	60 2 23/64	1.8 4.0	2.2 4.9
UK307D1;H2307X UK307D1;HS2307	FS307D1 FS307D1	C(CM)-UKFS307D1;H2307X C(CM)-UKFS307SD1;HS2307	3 1/8	67 2 11/64	2.3 5.1	2.9 6.4
UK308D1;H2308X UK308D1;HE2308X UK308D1;HS2308X	FS308D1 FS308D1 FS308D1	C(CM)-UKFS308D1;H2308X C(CM)-UKFS308ED1;HE2308X C(CM)-UKFS308SD1;HS2308X	3 1/8	76 2 63/64	3.2 7.1	3.7 8.2
UK309D1;H2309X UK309D1;HA2309 UK309D1;HE2309X UK309D1;HS2309X	FS309D1 FS309D1 FS309D1 FS309D1	C(CM)-UKFS309D1;H2309X C(CM)-UKFS309AD1;HA2309 C(CM)-UKFS309ED1;HE2309X C(CM)-UKFS309SD1;HS2309X	3 1/8	80 3 5/32	3.8 8.4	4.7 10
UK310D1;H2310X UK310D1;HS2310 UK310D1;HA2310 UK310D1;HE2310X	FS310D1 FS310D1 FS310D1 FS310D1	C(CM)-UKFS310D1;H2310X C(CM)-UKFS310SD1;HS2310 C(CM)-UKFS310AD1;HA2310 C(CM)-UKFS310ED1;HE2310X	3 1/8	88 3 15/32	5.1 11	6.3 14
UK311D1;H2311X UK311D1;HS2311 UK311D1;HA2311 UK311D1;HE2311XY	FS311D1 FS311D1 FS311D1 FS311D1	C(CM)-UKFS311D1;H2311X C(CM)-UKFS311SD1;HS2311 C(CM)-UKFS311AD1;HA2311 C(CM)-UKFS311ED1;HE2311XY	4 5/32	93 3 21/32	5.9 13	7.3 16
UK312D1;H2312X UK312D1;HS2312	FS312D1 FS312D1	C(CM)-UKFS312D1;H2312X C(CM)-UKFS312SD1;HS2312	4 5/32	100 3 15/16	7.0 15	8.4 19

Square flanged unit, cast housing with spigot Adapter type

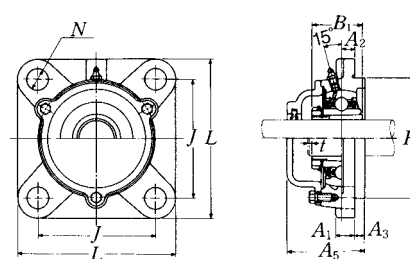
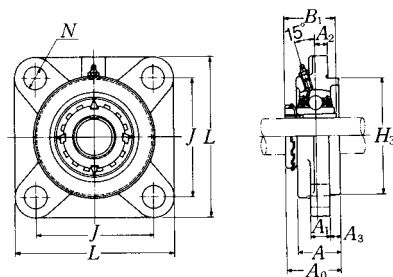

Cast dust cover type
 Open end **C-UKFS...D1**
 Closed end **CM-UKFS...D1**

Shaft dia. mm inch	Unit number ⁽¹⁾ (²)	Nominal dimensions										Bolt size mm inch
		<i>L</i>	<i>J</i>	<i>A</i> ₂	<i>N</i>	<i>A</i> ₃	<i>A</i> ₁	<i>A</i>	<i>H</i> ₃	<i>A</i> ₀	<i>B</i> ₁	
60 2 3/16 2 1/4 2 3/8	UKFS313D1;H2313X UKFS313D1;HA2313 UKFS313D1;HE2313X UKFS313D1;HS2313X	208	166	15	33	18	22	58	175	71.5	65	M20
		8 3/16	6 17/32	19/32	29/32	45/64	7/8	2 9/32	6.8898	2 13/16	2.559	3/4
65 2 7/16 2 1/2	UKFS315D1;H2315X UKFS315D1;HA2315 UKFS315D1;HE2315X	236	184	21	25	18	25	66	200	81.5	73	M22
		9 9/32	7 1/4	53/64	63/64	45/64	31/32	2 19/32	7.8740	3 13/64	2.874	7/8
70 2 11/16 2 3/4	UKFS316D1;H2316X UKFS316D1;HA2316 UKFS316D1;HE2316X	250	196	18	31	20	27	68	210	84	78	M27
		9 27/32	7 23/32	45/64	1 1/32	25/32	1 1/16	2 43/64	8.2677	3 5/16	3.071	1
75 2 5/16 3	UKFS317D1;H2317X UKFS317D1;HA2317X UKFS317D1;HE2317X	260	204	24	31	20	27	74	220	92	82	M27
		10 1/4	8 1/32	15/16	1 1/32	25/32	1 1/16	2 29/32	8.6614	3 5/8	3.228	1
80 3 3/16	UKFS318D1;H2318X UKFS318D1;HA2318X	280	216	24	35	20	30	76	240	94	86	M30
		11 1/32	8 1/2	15/16	1 3/8	25/32	1 3/16	2 63/64	9.4488	3 45/64	3.386	1 1/8
85 3 1/4	UKFS319D1;H2319X UKFS319D1;HE2319X	290	228	39	35	20	30	94	250	111.5	90	M30
		11 3/32	8 31/32	1 17/32	1 3/8	25/32	1 3/16	3 45/64	9.8425	4 25/64	3.543	1 1/8
90 3 7/16 3 1/2	UKFS320D1;H2320X UKFS320D1;HA2320 UKFS320D1;HE2320X	310	242	39	38	20	32	94	260	115.5	97	M33
		12 7/32	9 17/32	1 17/32	1 1/2	25/32	1 1/4	3 45/64	10.2362	4 35/64	3.819	1 1/4
100	UKFS322D1;H2322X	340	266	35	41	25	35	96	300	121	105	M36
110	UKFS324D1;H2324	370	290	35	41	30	40	110	330	130	112	M36
115	UKFS326D1;H2326	410	320	35	41	30	45	115	360	133	121	M36
125	UKFS328D1;H2328	450	350	45	41	30	55	125	400	146.5	131	M36

Notes ⁽¹⁾ These numbers indicate relubricatable type. If maintenance free type is needed, please order without suffix "D1".
⁽²⁾ Adapter number with suffix "X" means a narrow slot type adapter sleeve.
 In this case the lock washer with the straight inner prong should be used.
⁽³⁾ If the inch series housing units with dust cover are ordered with a closed end, the suffixes E, S or A are not included.
 Example: CM-UKFS305D1;HE2305

Remarks Please refer to page A21 for size of grease fitting.

Bearing number	Housing number	Unit number ⁽²⁾ cast dust cover type	Nominal dimensions		Mass of unit	
			<i>t</i> max.	<i>A</i> ₅	UKFS	C(CM)
UK313D1;H2313X UK313D1;HA2313 UK313D1;HE2313X UK313D1;HS2313X	FS313D1 FS313D1 FS313D1 FS313D1	C(CM)-UKFS313D1;H2313X C(CM)-UKFS313AD1;HA2313 C(CM)-UKFS313ED1;HE2313X C(CM)-UKFS313SD1;HS2313X	4 5/32	103 4 1/16	8.4 19	10 22
UK315D1;H2315X UK315D1;HA2315 UK315D1;HE2315X	FS315D1 FS315D1 FS315D1	C(CM)-UKFS315D1;H2315X C(CM)-UKFS315AD1;HA2315 C(CM)-UKFS315ED1;HE2315X	4 5/32	114 4 31/64	12 26	14 31
UK316D1;H2316X UK316D1;HA2316 UK316D1;HE2316X	FS316D1 FS316D1 FS316D1	C(CM)-UKFS316D1;H2316X C(CM)-UKFS316AD1;HA2316 C(CM)-UKFS316ED1;HE2316X	4 5/32	116 4 9/16	15 33	17 37
UK317D1;H2317X UK317D1;HA2317X UK317D1;HE2317X	FS317D1 FS317D1 FS317D1	C(CM)-UKFS317D1;H2317X C(CM)-UKFS317AD1;HA2317X C(CM)-UKFS317ED1;HE2317X	5 13/64	129 5 5/64	17 37	20 44
UK318D1;H2318X UK318D1;HA2318X	FS318D1 FS318D1	C(CM)-UKFS318D1;H2318X C(CM)-UKFS318AD1;HA2318X	5 13/64	129 5 5/64	21 46	24 53
UK319D1;H2319X UK319D1;HE2319X	FS319D1 FS319D1	C(CM)-UKFS319D1;H2319X C(CM)-UKFS319ED1;HE2319X	5 13/64	149 5 55/64	24 53	29 64
UK320D1;H2320X UK320D1;HA2320 UK320D1;HE2320X	FS320D1 FS320D1 FS320D1	C(CM)-UKFS320D1;H2320X C(CM)-UKFS320AD1;HA2320 C(CM)-UKFS320ED1;HE2320X	5 13/64	154 6 1/16	29 64	34 75
UK322D1;H2322X	FS322D1	C(CM)-UKFS322D1;H2322X	5	160	38	46
UK324D1;H2324	FS324D1	C(CM)-UKFS324D1;H2324	5	172	51	59
UK326D1;H2326	FS326D1	C(CM)-UKFS326D1;H2326	6	178	69	79
UK328D1;H2328	FS328D1	C(CM)-UKFS328D1;H2328	6	192	98	110

Round flanged unit, cast housing with spigot joint Adapter type

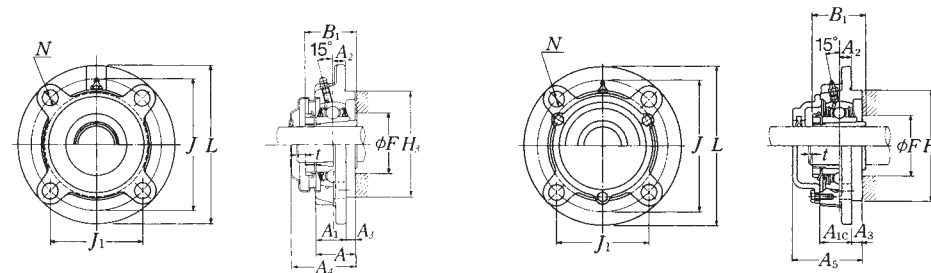
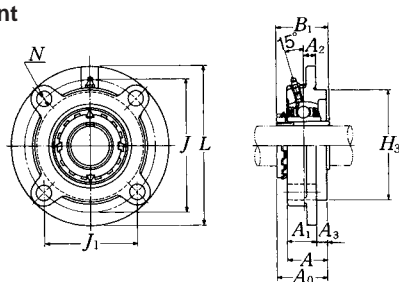

Pressed steel dust cover type

Open end **Z-UKFC...D1**
Closed end **ZM-UKFC...D1**

Cast dust cover type

Open end **C-UKFC...D1**
Closed end **CM-UKFC...D1**

Shaft dia. mm inch	Unit number ⁽¹⁾ (²)(³)	Nominal dimensions													Bolt size mm inch	Bearing number
		mm inch														
		L	J	(J ₁)	A ₂	N	A ₃	A ₁	A	H ₃	A ₀	B ₁	F	min.		
20 3/4	UKFC205D1;H2305X UKFC205D1;HE2305	115 4 17/32	90 3 5/8	63.6 2 1/2	10 25/64	12 15/32	6 15/64	21 13/16	27 1 1/16	70 2.7559	35.5 1 25/64	35 1.378	30 1 3/16	M10 3/8	UK205D1;H2305X UK205D1;HE2305	
25 7/8 1	UKFC206D1;H2306X UKFC206D1;HS2306 UKFC206D1;HE2306X	125 4 29/32	100 3 15/16	70.7 2 25/32	10 25/64	12 15/32	8 5/16	23 29/32	31 1 7/32	80 3.1496	39 1 17/32	38 1.496	36 1 13/32	M10 3/8	UK206D1;H2306X UK206D1;HS2306 UK206D1;HE2306X	
30 1 1/8	UKFC207D1;H2307X UKFC207D1;HS2307	135 5 1/16	110 4 21/64	77.8 3 1/16	11 7/16	14 35/64	8 5/16	26 1 1/32	34 1 11/32	90 3.5433	42.5 1 43/64	43 1.693	40 1 9/16	M12 7/16	UK207D1;H2307X UK207D1;HS2307	
35 1 1/4 1 3/8	UKFC208D1;H2308X UKFC208D1;HE2308X UKFC208D1;HS2308X	145 5 23/32	120 4 23/32	84.9 3 11/32	11 7/16	14 35/64	10 25/64	26 1 1/32	36 1 27/64	100 3.9370	46.5 1 53/64	46 1.811	46 1 13/16	M12 7/16	UK208D1;H2308X UK208D1;HE2308X UK208D1;HS2308X	
40 1 7/16 1 1/2 1 5/8	UKFC209D1;H2309X UKFC209D1;HA2309 UKFC209D1;HE2309X UKFC209D1;HS2309X	160 6 5/16	132 5 13/64	93.3 3 43/64	10 25/64	16 5/8	12 15/32	26 1 1/32	38 1 1/2	105 4.1339	48.5 1 29/32	50 1.969	52 2 1/16	M14 1/2	UK209D1;H2309X UK209D1;HA2309 UK209D1;HE2309X UK209D1;HS2309X	
45 1 5/8 1 11/16 1 3/4	UKFC210D1;H2310X UKFC210D1;HS2310 UKFC210D1;HA2310 UKFC210D1;HE2310X	165 6 1/2	138 5 7/16	97.6 3 27/32	10 25/64	16 5/8	12 15/32	28 1 3/32	40 1 37/64	110 4.3307	50 1 31/32	55 2.165	57 2 1/4	M14 1/2	UK210D1;H2310X UK210D1;HS2310 UK210D1;HA2310 UK210D1;HE2310X	
50 1 7/8 1 15/16 2	UKFC211D1;H2311X UKFC211D1;HS2311 UKFC211D1;HA2311 UKFC211D1;HE2311XY	185 7 9/32	150 5 29/32	106.1 4 11/64	13 33/64	19 3/4	12 15/32	31 1 7/32	43 1 11/16	125 4.9213	54.5 2 9/64	59 2.323	64 2 17/32	M16 5/8	UK211D1;H2311X UK211D1;HS2311 UK211D1;HA2311 UK211D1;HE2311XY	
55 2 1/8	UKFC212D1;H2312X UKFC212D1;HS2312	195 7 11/16	160 6 19/64	113.1 4 29/64	17 43/64	19 3/4	12 15/32	36 1 13/32	48 1 57/64	135 5.3150	61 2 13/32	62 2.441	69 2 23/32	M16 5/8	UK212D1;H2312X UK212D1;HS2312	

Housing number	Unit number ⁽⁴⁾ pressed steel dust cover type	Unit number ⁽⁴⁾ cast dust cover type	Nominal dimensions				Mass of unit		
			mm inch				kg lb		
			t max.	A ₄	A _{1c}	A ₅	UKFC	Z(ZM)	C(CM)
FC205D1	Z(ZM)-UKFC205D1;H2305X	C(CM)-UKFC205D1;H2305X	2 5/64	40 1 19/32	22 7/8	51 2	1.0 2.2	1.1 2.4	1.2 2.6
FC206D1	Z(ZM)-UKFC206D1;H2306X	C(CM)-UKFC206D1;H2306X	2 5/64	45 1 3/4	24.5 3 1/2	56 2 13/64	1.3 2.9	1.4 3.1	1.7 3.7
FC207D1	Z(ZM)-UKFC207D1;H2307X	C(CM)-UKFC207D1;H2307X	3 1/8	49 1 15/16	26 1 1/2	59 2 51/64	1.7 3.7	1.8 4.0	2.0 4.4
FC208D1	Z(ZM)-UKFC208D1;H2308X	C(CM)-UKFC208D1;H2308X	3 1/8	56 2 3/16	27.5 1 5/64	66 2 9/32	2.1 4.6	2.2 4.9	2.6 5.7
FC209D1	Z(ZM)-UKFC209D1;H2309X	C(CM)-UKFC209D1;H2309X	3 1/8	57 2 1/4	28 1 7/64	70 2 3/4	2.8 6.2	2.9 6.4	3.4 7.5
FC210D1	Z(ZM)-UKFC210D1;H2310X	C(CM)-UKFC210D1;H2310X	3 1/8	60 2 3/8	29 3 3/8	72 2 53/64	3.1 6.8	3.3 7.3	4.8 11
FC211D1	Z(ZM)-UKFC211D1;H2311X	C(CM)-UKFC211D1;H2311X	4 5/32	64 2 1/2	32.5 3 3/8	75 2 29/64	4.2 9.3	4.4 9.7	5.1 11
FC212D1	Z(ZM)-UKFC212D1;H2312X	C(CM)-UKFC212D1;H2312X	4 5/32	74 2 29/32	38 3 3/8	86 3 25/64	5.0 11	5.2 11	6.1 13

- Notes ⁽¹⁾ These numbers indicate relubricatable type. If maintenance free type is needed, please order without suffix "D1".
⁽²⁾ Adapter number with suffix "X" means a narrow slot type adapter sleeve. In this case the lock washer with the straight inner prong should be used.
⁽³⁾ For HE2311XY, screw thread pitch different from the standard is applied, because of the thin thread section of sleeve. To distinguish it, a suffix "Y" is added.
⁽⁴⁾ If the inch series housing units with dust cover are ordered with a closed end, the suffixes E, S or A are not included. Example: ZM-UKFC205D1;HE2305

Remarks Please refer to page A21 for size of grease fitting.

Round flanged unit, cast housing with spigot joint Adapter type

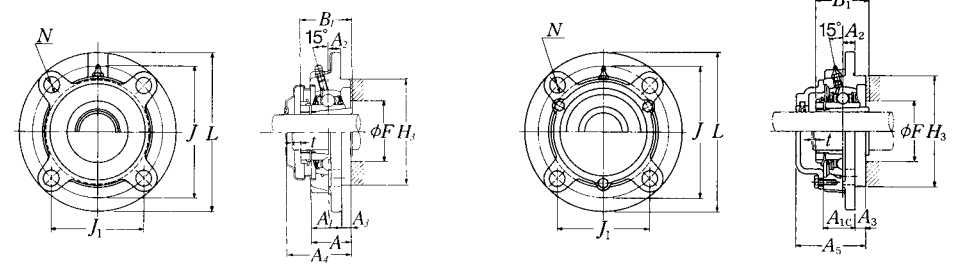
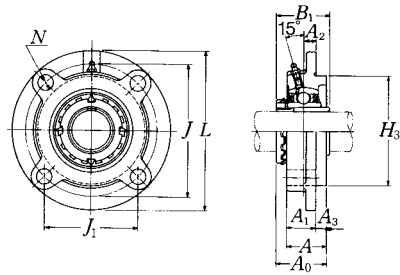

Pressed steel dust cover type
Open end **Z-UKFC...D1**
Closed end **ZM-UKFC...D1**

Cast dust cover type
Open end **C-UKFC...D1**
Closed end **CM-UKFC...D1**

Shaft dia. mm inch	Unit number ⁽¹⁾⁽²⁾	Nominal dimensions													Bolt size mm inch	Bearing number
		mm inch														
		L	J	(J ₁)	A ₂	N	A ₃	A ₁	A	H ₃	A ₀	B ₁	F	mm min.		
60 2 3/16 2 1/4 2 3/8	UKFC213D1;H2313X UKFC213D1;HA2313 UKFC213D1;HE2313X UKFC213D1;HS2313X	205	170	120.2	16	19	14	36	50	145	64	65	74	M16	UK213D1;H2313X UK213D1;HA2313 UK213D1;HE2313X UK213D1;HS2313X	
65 2 7/16 2 1/2	UKFC215D1;H2315X UKFC215D1;HA2315 UKFC215D1;HE2315X	220	184	130.1	18	19	16	40	56	160	71	73	84	M16	UK215D1;H2315X UK215D1;HA2315 UK215D1;HE2315X	
70 2 11/16 2 3/4	UKFC216D1;H2316X UKFC216D1;HA2316 UKFC216D1;HE2316X	240	200	141.4	18	23	16	42	58	170	73.5	78	90	M20	UK216D1;H2316X UK216D1;HA2316 UK216D1;HE2316X	
75 2 5/8 3	UKFC217D1;H2317X UKFC217D1;HA2317X UKFC217D1;HE2317X	250	208	147.1	18	23	18	45	63	180	77	82	95	M20	UK217D1;H2317X UK217D1;HA2317X UK217D1;HE2317X	
80 3 3/16	UKFC218D1;H2318X UKFC218D1;HA2318X	265	220	155.6	22	23	18	50	68	190	81.5	86	102	M20	UK218D1;H2318X UK218D1;HA2318X	

Housing number	Unit number ⁽³⁾ pressed steel dust cover type	Unit number ⁽³⁾ cast dust cover type	Nominal dimensions				Mass of unit		
			mm inch				kg lb		
			t max.	A ₄	A _{1c}	A ₅	UKFC	Z(ZM)	C(CM)
FC213D1 FC213D1 FC213D1 FC213D1	Z(ZM)-UKFC213D1;H2313X Z(ZM)-UKFC213AD1;HA2313 Z(ZM)-UKFC213ED1;HE2313X Z(ZM)-UKFC213SD1;HS2313X	C(CM)-UKFC213D1;H2313X C(CM)-UKFC213AD1;HA2313 C(CM)-UKFC213ED1;HE2313X C(CM)-UKFC213SD1;HS2313X	4 5/32	76 3	38 3 3/8	89.5 3 17/32	6.0 13	6.1 13	7.1 16
FC215D1 FC215D1 FC215D1	— — —	C(CM)-UKFC215D1;H2315X C(CM)-UKFC215AD1;HA2315 C(CM)-UKFC215ED1;HE2315X	4 5/32	— —	43 1 11/16	102 4 1/4	7.7 17	— —	9.3 21
FC216D1 FC216D1 FC216D1	— — —	C(CM)-UKFC216D1;H2316X C(CM)-UKFC216AD1;HA2316 C(CM)-UKFC216ED1;HE2316X	4 5/32	— —	43 1 11/16	106 4 11/64	9.5 21	— —	11 24
FC217D1 FC217D1 FC217D1	— — —	C(CM)-UKFC217D1;H2317X C(CM)-UKFC217AD1;HA2317X C(CM)-UKFC217ED1;HE2317X	5 1 3/8	— —	45.5 1 51/64	114 4 31/64	11 24	— —	13 29
FC218D1 FC218D1	— —	C(CM)-UKFC218D1;H2318X C(CM)-UKFC218AD1;HA2318X	5 1 3/8	— —	50 1 31/32	122 4 51/64	13 29	— —	15 33

Notes (1) These numbers indicate relubricatable type. If maintenance free type is needed, please order without suffix "D1".
(2) Adapter number with suffix "X" means a narrow slot type adapter sleeve. In this case the lock washer with the straight inner prong should be used.
(3) If the inch series housing units with dust cover are ordered with a closed end, the suffixes E, S or A are not included. Example: ZM-UKFC205D1;HE2305

Remarks Please refer to page A21 for size of grease fitting.

Round flanged unit, cast housing with spigot joint Adapter type

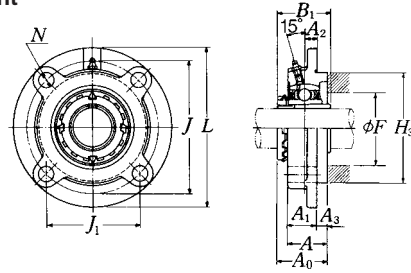

Shaft dia. mm inch	Unit number ⁽¹⁾ (⁽²⁾) ⁽³⁾	Nominal dimensions												
		L	J	(J ₁)	A ₂	N	A ₃	A ₁	A	H ₃	A ₀	B ₁	F min.	
20 3/4	UKFCX05D1;H2305X UKFCX05D1;HE2305	111 4 3/8	92 3 5/8	65.1 2 9/16	10 25/64	9.5 3/8	6 1/4	24 15/16	30 1 3/16	76 2.9921	37 1 29/64	35 1.378	30 1 3/16	
25 7/8 1	UKFCX06D1;H2306X UKFCX06D1;HS2306 UKFCX06D1;HE2306X	127 5	105 4 9/64	74.2 2 59/64	8 5/16	12 15/32	9.5 3/8	22.5 7/8	32 1 17/64	85 3.3465	40 1 37/64	38 1.496	36 1 13/32	
30 1 1/8	UKFCX07D1;H2307X UKFCX07D1;HS2307	133 5 1/4	111 4 3/8	78.5 3 3/32	9 23/64	12 15/32	11 7/16	26 1 1/32	37 1 29/64	92 3.6220	44.5 1 3/4	43 1.693	40 1 9/16	
35 1 1/4 1 3/8	UKFCX08D1;H2308X UKFCX08D1;HE2308X UKFCX08D1;HS2308X	133 5 1/4	111 4 3/8	78.5 3 3/32	9 23/64	12 15/32	11 7/16	26 1 1/32	37 1 29/64	92 3.6220	45.5 1 51/64	46 1.811	46 1 13/16	
40 1 7/16 1 1/2 1 5/8	UKFCX09D1;H2309X UKFCX09D1;HA2309 UKFCX09D1;HE2309X UKFCX09D1;HS2309X	155 6 3/32	130 5 1/8	91.9 3 5/8	8 5/16	14 35/64	12 15/32	25 31/32	37 1 29/64	108 4.2520	47 1 27/32	50 1.969	52 2 1/16	
45 1 5/8 1 11/16 1 3/4	UKFCX10D1;H2310X UKFCX10D1;HS2310 UKFCX10D1;HA2310 UKFCX10D1;HE2310X	162 6 3/8	136 5 23/64	96.2 3 25/32	7 9/32	14 35/64	16 5/8	25 31/32	41 1 39/64	118 4.6457	52.5 2 1/16	55 2.165	57 2 1/4	
50 1 7/8 1 15/16 2	UKFCX11D1;H2311X UKFCX11D1;HS2311 UKFCX11D1;HA2311 UKFCX11D1;HE2311XY	180 7 3/32	152 5 63/64	107.5 4 15/64	4 5/32	16 5/8	22 55/64	26 1 1/32	48 1 57/64	127 5.0000	57 2 1/4	59 2.323	64 2 17/32	
55 2 1/8	UKFCX12D1;H2312X UKFCX12D1;HS2312	194 7 5/8	165 6 1/2	116.7 4 19/32	11 7/16	16 5/8	20 25/32	33 1 5/16	53 2 5/64	140 5.5118	64 2 33/64	62 2.441	69 2 23/32	

Notes ⁽¹⁾ These numbers indicate relubricatable type. If maintenance free type is needed, please order without suffix "D1".

⁽²⁾ Adapter number with suffix "X" means a narrow slot type adapter sleeve.
In this case the lock washer with the straight inner prong should be used.

⁽³⁾ For HE2311XY, screw thread pitch different from the standard is applied, because of the thin thread section of sleeve.
To distinguish it, a suffix "Y" is added.

Remarks Please refer to page A21 for size of grease fitting.

Bolt size mm inch	Bearing number	Housing number	Mass of unit kg lb
M8 5/16	UKX05D1;H2305X UKX05D1;HE2305	FCX05D1 FCX05D1	1.2 2.6
M10 5/8	UKX06D1;H2306X UKX06D1;HS2306 UKX06D1;HE2306X	FCX06D1 FCX06D1 FCX06D1	1.5 3.3
M10 3/8	UKX07D1;H2307X UKX07D1;HS2307	FCX07D1 FCX07D1	1.9 4.2
M10 3/8	UKX08D1;H2308X UKX08D1;HE2308X UKX08D1;HS2308X	FCX08D1 FCX08D1 FCX08D1	2.2 4.9
M12 7/16	UKX09D1;H2309X UKX09D1;HA2309 UKX09D1;HE2309X UKX09D1;HS2309X	FCX09D1 FCX09D1 FCX09D1 FCX09D1	2.7 6.0
M12 7/16	UKX10D1;H2310X UKX10D1;HS2310 UKX10D1;HA2310 UKX10D1;HE2310X	FCX10D1 FCX10D1 FCX10D1 FCX10D1	3.1 6.8
M14 1/2	UKX11D1;H2311X UKX11D1;HS2311 UKX11D1;HA2311 UKX11D1;HE2311XY	FCX11D1 FCX11D1 FCX11D1 FCX11D1	4.2 9.3
M14 1/2	UKX12D1;H2312X UKX12D1;HS2312	FCX12D1 FCX12D1	5.5 12

Round flanged unit, cast housing with spigot joint Adapter type

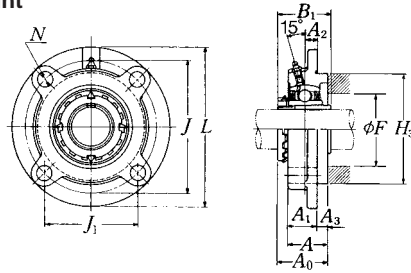

Shaft dia. mm inch	Unit number ⁽¹⁾⁽²⁾	Nominal dimensions											
		L	J	(J ₁)	A ₂	N	A ₃	A ₁	A	H ₃	A ₀	B ₁	F min.
60 2 3/16 2 1/4 2 3/8	UKFCX13D1;H2313X UKFCX13D1;HA2313 UKFCX13D1;HE2313X UKFCX13D1;HS2313X	194	165	116.7	11	16	20	33	53	140	66	74	
		7 5/8	6 1/2	4 19/32	7/16	5/8	25/32	1 5/16	2 5/64	5.5118	2 19/32	2.559	2 29/32
65 2 7/16 2 1/2	UKFCX15D1;H2315X UKFCX15D1;HA2315 UKFCX15D1;HE2315X	222	190	134.4	12	19	22	35	57	164	71.5	84	
		8 3/4	7 31/64	5 9/32	15/32	3/4	55/64	1 3/8	2 1/4	6.4567	2 13/16	2.874	3 5/16
70 2 11/16 2 3/4	UKFCX16D1;H2316X UKFCX16D1;HA2316 UKFCX16D1;HE2316X	260	219	154.9	10	23	25	36	61	186	75	90	
		10 1/4	8 5/8	6 3/32	25/64	29/32	63/64	1 13/32	2 13/32	7.3228	2 61/64	3.071	3 17/32
75 2 15/16 3	UKFCX17D1;H2317X UKFCX17D1;HA2317X UKFCX17D1;HE2317X	260	219	154.9	10	23	25	36	61	186	76.5	82	95
		10 1/4	8 5/8	6 3/32	25/64	29/32	63/64	1 13/32	2 13/32	7.3228	3 1/64	3.228	3 3/4
80 3 3/16	UKFCX18D1;H2318X UKFCX18D1;HA2318X	260	219	154.9	12	23	28	43	71	186	82.5	86	102
		10 1/4	8 5/8	6 3/32	15/32	29/32	1 7/64	1 11/16	2 51/64	7.3228	3 1/4	3.386	4 1/32
90	UKFCX20D1;H2320X	276	238	168.3	22	23	28	66	94	206	98.5	97	112

Notes ⁽¹⁾ These numbers indicate relubricatable type. If maintenance free type is needed, please order without suffix "D1".

⁽²⁾ Adapter number with suffix "X" means a narrow slot type adapter sleeve.

In this case the lock washer with the straight inner prong should be used.

Remarks Please refer to page A21 for size of grease fitting.

Bolt size mm inch	Bearing number	Housing number	Mass of unit kg lb
M14 1/2	UKX13D1;H2313X UKX13D1;HA2313 UKX13D1;HE2313X UKX15D1;HS2313X	FCX13D1 FCX13D1 FCX13D1 FCX13D1	5.4 12
M16 5/8	UKX15D1;H2315X UKX15D1;HA2315 UKX15D1;HE2315X	FCX15D1 FCX15D1 FCX15D1	8.2 18
M20 3/4	UKX16D1;H2316X UKX16D1;HA2316 UKX16D1;HE2316X	FCX16D1 FCX16D1 FCX16D1	12 26
M20 3/4	UKX17D1;H2317X UKX17D1;HA2317X UKX17D1;HE2317X	FCX17D1 FCX17D1 FCX17D1	12 26
M20 3/4	UKX18D1;H2318X UKX18D1;HA2318X	FCX18D1 FCX18D1	12 26
M20	UKX20D1;H2320X	FCX20D1	18

Rhombus flanged unit, cast housing Adapter type

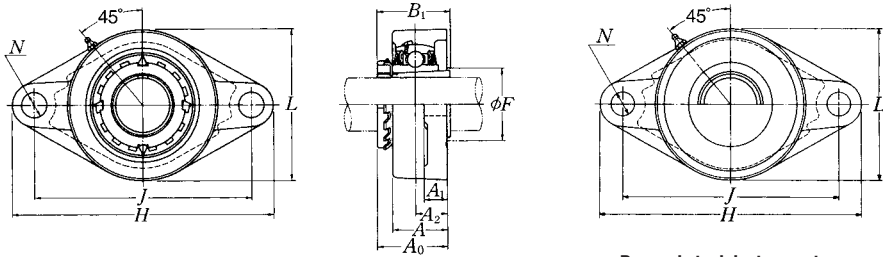

Pressed steel dust cover type
Open end **Z-UKFL...D1**
Closed end **ZM-UKFL...D1**

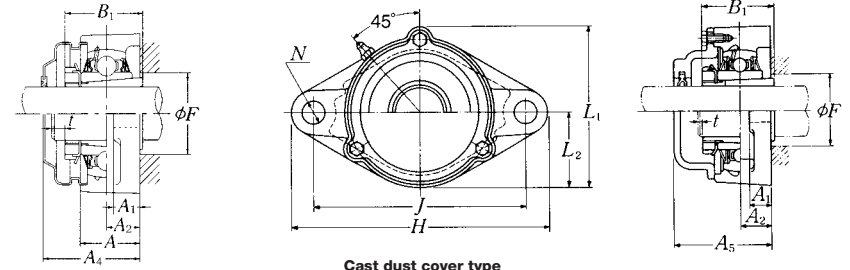

Cast dust cover type
Open end **C-UKFL...D1**
Closed end **CM-UKFL...D1**

Shaft dia. mm inch	Unit number ⁽¹⁾ / ₍₂₎ / ₍₃₎	Nominal dimensions											Bolt size mm inch	Bearing number
		H	J	A ₂	A ₁	mm inch		L	A ₀	B ₁	F min.	mm inch		
20 3/4	UKFL205D1;H2305X UKFL205D1;HE2305	130 5 1/8	99 3 57/64	16 5/8	13 1/2	27 1 1/16	16 5/8	68 2 11/16	35.5 1 25/64	35	30 1 1/8	M14 1/2	UK205D1;H2305X UK205D1;HE2305	
25 7/8 1	UKFL206D1;H2306X UKFL206D1;HS2306 UKFL206D1;HE2306X	148 5 13/16	117 4 39/64	18 45/64	13 1/2	31 1 7/32	16 5/8	80 3 5/32	39 1 17/32	38 1.496	36 1 13/32	M14 1/2	UK206D1;H2306X UK206D1;HS2306 UK206D1;HE2306X	
30 1 1/8	UKFL207D1;H2307X UKFL207D1;HS2307	161 6 11/32	130 5 1/8	19 3/4	15 19/32	34 1 11/32	16 5/8	90 3 7/32	42.5 1 43/64	43 1.693	40 1 9/16	M14 1/2	UK207D1;H2307X UK207D1;HS2307	
35 1 1/4 1 3/8	UKFL208D1;H2308X UKFL208D1;HE2308X UKFL208D1;HS2308X	175 6 7/8	144 5 43/64	21 53/64	15 19/32	36 1 13/32	16 5/8	100 3 15/16	46.5 1 53/64	46 1.811	46 1 13/16	M14 1/2	UK208D1;H2308X UK208D1;HE2308X UK208D1;HS2308X	
40 1 7/16 1 1/2 1 5/8	UKFL209D1;H2309X UKFL209D1;HA2309 UKFL209D1;HE2309X UKFL209D1;HS2309X	188 7 13/32	148 5 53/64	22 55/64	16 5/8	38 1 1/2	19 3/4	108 4 1/4	48.5 1 29/32	50 1.969	52 2 1/16	M16 5/8	UK209D1;H2309X UK209D1;HA2309 UK209D1;HE2309X UK209D1;HS2309X	
45 1 5/8 1 11/16 1 3/4	UKFL210D1;H2310X UKFL210D1;HS2310 UKFL210D1;HA2310 UKFL210D1;HE2310X	197 7 3/4	157 6 3/16	22 55/64	16 5/8	40 1 9/16	19 3/4	115 4 17/32	50 1 31/32	55 2.165	57 2 1/4	M16 5/8	UK210D1;H2310X UK210D1;HS2310 UK210D1;HA2310 UK210D1;HE2310X	
50 1 7/8 1 15/16 2	UKFL211D1;H2311X UKFL211D1;HS2311 UKFL211D1;HA2311 UKFL211D1;HE2311XY	224 8 13/16	184 7 1/4	25 63/64	18 23/32	43 1 11/16	19 3/4	130 5 1/8	54.5 2 9/64	59 2.323	64 2 17/32	M16 5/8	UK211D1;H2311X UK211D1;HS2311 UK211D1;HA2311 UK211D1;HE2311XY	
55 2 1/8	UKFL212D1;H2312X UKFL212D1;HS2312	250 9 27/32	202 7 61/64	29 1 9/64	18 23/32	48 1 7/8	23 29/32	140 5 1/2	61 2 13/32	62 2.441	69 2 23/32	M20 3/4	UK212D1;H2312X UK212D1;HS2312	

- Notes ⁽¹⁾ These numbers indicate relubricatable type. If maintenance free type is needed, please order without suffix "D1".
⁽²⁾ Adapter number with suffix "X" means a narrow slot type adapter sleeve. In this case the lock washer with the straight inner prong should be used.
⁽³⁾ For HE2311XY, screw thread pitch different from the standard is applied, because of the thin thread section of sleeve. To distinguish it, a suffix "Y" is added.
⁽⁴⁾ If the inch series housing units with dust cover are ordered with a closed end, the suffixes E, S or A are not included. Example: ZM-UKFL205D1;HE2305

Remarks Please refer to page A21 for size of grease fitting.

Housing number	Unit number ⁽⁴⁾ pressed steel dust cover type	Unit number ⁽⁴⁾ cast dust cover type	Nominal dimensions					Mass of unit		
			t max.	mm inch		L ₁	L ₂	kg lb		
FL205D1	Z(ZM)-UKFL205D1;H2305X	C(CM)-UKFL205D1;H2305X	2	40	51	74	34	0.6	0.7	0.8
FL205D1	Z(ZM)-UKFL205ED1;HE2305	C(CM)-UKFL205ED1;HE2305	5/64	1 19/32	2	2 29/32	1 11/32	1.3	1.5	1.8
FL206D1	Z(ZM)-UKFL206D1;H2306X	C(CM)-UKFL206D1;H2306X	2	45	56	85	40	0.9	1.0	1.2
FL206D1	Z(ZM)-UKFL206SD1;HS2306	C(CM)-UKFL206SD1;HS2306	5/64	1 3/4	2 7/32	3 11/32	1 9/16	2.0	2.2	2.9
FL206D1	Z(ZM)-UKFL206ED1;HE2306X	C(CM)-UKFL206ED1;HE2306X								
FL207D1	Z(ZM)-UKFL207D1;H2307X	C(CM)-UKFL207D1;H2307X	3	49	59	97	45	1.3	1.3	1.6
FL207D1	Z(ZM)-UKFL207SD1;HS2307	C(CM)-UKFL207SD1;HS2307	1/8	1 15/16	2 5/16	3 13/16	1 25/32	2.9	2.9	3.5
FL208D1	Z(ZM)-UKFL208D1;H2308X	C(CM)-UKFL208D1;H2308X	3	56	66	106	50	1.6	1.7	2.1
FL208D1	Z(ZM)-UKFL208ED1;HE2308X	C(CM)-UKFL208ED1;HE2308X	1/8	2 3/16	2 19/32	4 3/16	1 31/32	3.5	3.7	4.6
FL208D1	Z(ZM)-UKFL208SD1;HS2308X	C(CM)-UKFL208SD1;HS2308X								
FL209D1	Z(ZM)-UKFL209D1;H2309X	C(CM)-UKFL209D1;H2309X	3	57	70	113	54	2.0	2.1	2.5
FL209D1	Z(ZM)-UKFL209AD1;HA2309	C(CM)-UKFL209AD1;HA2309								
FL209D1	Z(ZM)-UKFL209ED1;HE2309X	C(CM)-UKFL209ED1;HE2309X	1/8	2 1/4	2 3/4	4 7/16	2 1/8	4.4	4.6	5.7
FL209D1	Z(ZM)-UKFL209SD1;HS2309X	C(CM)-UKFL209SD1;HS2309X								
FL210D1	Z(ZM)-UKFL210D1;H2310X	C(CM)-UKFL210D1;H2310X	3	60	72	120	58	2.2	2.4	2.9
FL210D1	Z(ZM)-UKFL210SD1;HS2310	C(CM)-UKFL210SD1;HS2310								
FL210D1	Z(ZM)-UKFL210AD1;HA2310	C(CM)-UKFL210AD1;HA2310	1/8	2 3/8	2 27/32	4 23/32	2 9/32	4.9	5.3	6.4
FL210D1	Z(ZM)-UKFL210ED1;HE2310X	C(CM)-UKFL210ED1;HE2310X								
FL211D1	Z(ZM)-UKFL211D1;H2311X	C(CM)-UKFL211D1;H2311X	4	64	75	133	65	3.1	3.4	3.7
FL211D1	Z(ZM)-UKFL211SD1;HS2311	C(CM)-UKFL211SD1;HS2311								
FL211D1	Z(ZM)-UKFL211AD1;HA2311	C(CM)-UKFL211AD1;HA2311	5/32	2 1/2	2 15/16	5 1/4	2 9/16	6.8	7.5	8.2
FL211D1	Z(ZM)-UKFL211ED1;HE2311XY	C(CM)-UKFL211ED1;HE2311XY								
FL212D1	Z(ZM)-UKFL212D1;H2312X	C(CM)-UKFL212D1;H2312X	4	74	86	144	70	3.9	4.2	4.7
FL212D1	Z(ZM)-UKFL212SD1;HS2312	C(CM)-UKFL212SD1;HS2312	5/32	2 29/32	3 3/8	5 21/32	2 3/4	8.6	9.3	10

Rhombus flanged unit, cast housing Adapter type

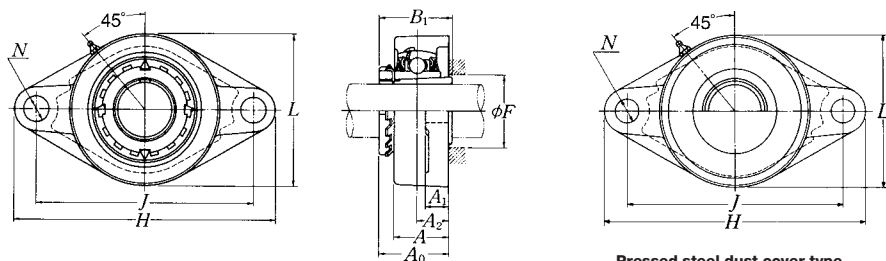

Pressed steel dust cover type
Open end **Z-UKFL...D1**
Closed end **ZM-UKFL...D1**

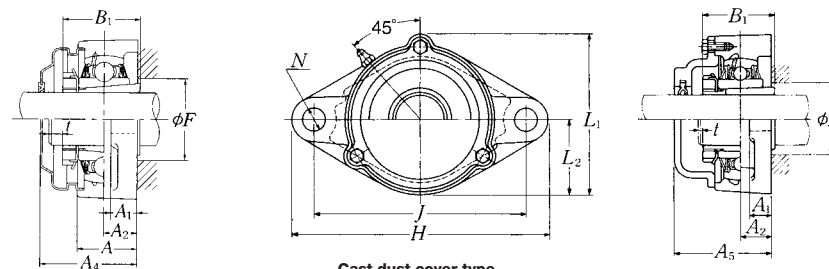

Cast dust cover type
Open end **C-UKFL...D1**
Closed end **CM-UKFL...D1**

Shaft dia. mm inch	Unit number ⁽¹⁾ (²)	Nominal dimensions											Bolt size mm inch	Bearing number
		H	J	A ₂	A ₁	mm inch		L	A ₀	B ₁	F	mm inch		
60 2 3/16 2 1/4 2 3/8	UKFL213D1;H2313X UKFL213D1;HA2313 UKFL213D1;HE2313X UKFL213D1;HS2313X	258	210	30	22	50	23	155	64	65	74	M20	UK213D1;H2313X UK213D1;HA2313 UK213D1;HE2313X UK213D1;HS2313X	
65 2 7/16 2 1/2	UKFL215D1;H2315X UKFL215D1;HA2315 UKFL215D1;HE2315X	275	225	34	22	56	23	165	71	73	84	M20	UK215D1;H2315X UK215D1;HA2315 UK215D1;HE2315X	
70 2 11/16 2 3/4	UKFL216D1;H2316X UKFL216D1;HA2316 UKFL216D1;HE2316X	290	233	34	22	58	25	180	73.5	78	90	M22	UK216D1;H2316X UK216D1;HA2316 UK216D1;HE2316X	
75 2 15/16 3	UKFL217D1;H2317X UKFL217D1;HA2317X UKFL217D1;HE2317X	305	248	36	24	63	25	190	77	82	95	M22	UK217D1;H2317X UK217D1;HA2317X UK217D1;HE2317X	
80 3 3/16	UKFL218D1;H2318X UKFL218D1;HA2318X	320	265	40	24	68	25	205	81.5	86	102	M22	UK218D1;H2318X UK218D1;HA2318X	

Notes ⁽¹⁾ These numbers indicate relubricatable type. If maintenance free type is needed, please order without suffix "D1".
⁽²⁾ Adapter number with suffix "X" means a narrow slot type adapter sleeve. In this case the lock washer with the straight inner prong should be used.
⁽³⁾ If the inch series housing units with dust cover are ordered with a closed end, the suffixes E, S or A are not included.
Example: ZM-UKFL205D1;HE2305

Remarks Please refer to page A21 for size of grease fitting.

Housing number	Unit number ⁽²⁾ pressed steel dust cover type	Unit number ⁽²⁾ cast dust cover type	Nominal dimensions					Mass of unit		
			t max.	mm inch		L ₁	L ₂	UKFL	Z(ZM)	C(CM)
FL213D1 FL213D1 FL213D1 FL213D1	Z(ZM)-UKFL213D1;H2313X Z(ZM)-UKFL213AD1;HA2313 Z(ZM)-UKFL213ED1;HE2313X Z(ZM)-UKFL213SD1;HS2313X	C(CM)-UKFL213D1;H2313X C(CM)-UKFL213AD1;HA2313 C(CM)-UKFL213ED1;HE2313X C(CM)-UKFL213SD1;HS2313X	4 5/32	76 3	90 3 17/32	157 6 3/16	78 3 1/16	5.0 11	5.4 12	6.0 13
FL215D1 FL215D1 FL215D1	— — —	C(CM)-UKFL215D1;H2315X C(CM)-UKFL215AD1;HA2315 C(CM)-UKFL215ED1;HE2315X	4 5/32	— 4 1/32	102 6 21/32	169 6 21/32	82 3 7/32	6.2 14	— —	7.6 17
FL216D1 FL216D1 FL216D1	— — —	C(CM)-UKFL216D1;H2316X C(CM)-UKFL216AD1;HA2316 C(CM)-UKFL216ED1;HE2316X	4 5/32	— 4 3/16	106 7 7/32	183 7 7/32	90 3 17/32	7.9 17	— —	9.3 21
FL217D1 FL217D1 FL217D1	— — —	C(CM)-UKFL217D1;H2317X C(CM)-UKFL217AD1;HA2317X C(CM)-UKFL217ED1;HE2317X	5 13/64	— 4 1/2	114 7 9/16	192 7 9/16	95 3 3/4	9.2 20	— —	11 24
FL218D1 FL218D1	— —	C(CM)-UKFL218D1;H2318X C(CM)-UKFL218AD1;HA2318X	5 13/64	— 4 13/16	122 8 1/16	205 8 1/16	102 4 1/32	11 24	— —	13 29

Rhombus flanged unit, cast housing Adapter type

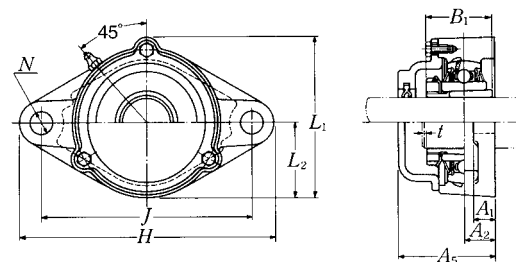
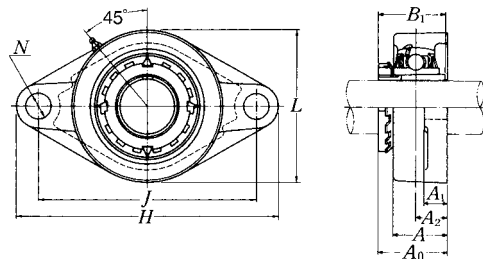

Cast dust cover type
Open end **C-UKFL...D1**
Closed end **CM-UKFL...D1**

Shaft dia. mm inch	Unit number ⁽¹⁾⁽²⁾⁽³⁾	Nominal dimensions									Bolt size mm inch
		mm inch									
		H	J	A ₂	A ₁	A	N	L	A ₀	B ₁	
20 3/4	UKFL305D1;H2305X UKFL305D1;HE2305	150 5 ²⁹ / ₃₂	113 4 ²⁹ / ₆₄	16 5/8	13 1/2	29 1 ⁵ / ₃₂	19 3/4	80 3 ⁵ / ₃₂	37 1 ²⁹ / ₆₄	35 1.378	M16 5/8
25 7/8 1	UKFL306D1;H2306X UKFL306D1;HS2306 UKFL306D1;HE2306X	180 7 ³ / ₃₂	134 5 ⁹ / ₃₂	18 45/64	15 19/32	32 1 ¹ / ₄	23 29/32	90 3 ¹⁷ / ₃₂	40.5 1 ¹⁹ / ₃₂	38 1.496	M20 3/4
30 1 1/8	UKFL307D1;H2307X UKFL307D1;HS2307	185 7 ⁹ / ₃₂	141 5 ³⁵ / ₆₄	20 25/32	16 5/8	36 1 ¹³ / ₃₂	23 29/32	100 3 ¹⁵ / ₁₆	45.5 1 ⁵¹ / ₆₄	43 1.693	M20 3/4
35 1 1/4 1 3/8	UKFL308D1;H2308X UKFL308D1;HE2308X UKFL308D1;HS2308X	200 7 ⁷ / ₈	158 6 ⁷ / ₃₂	23 29/32	17 21/32	40 1 ⁹ / ₁₆	23 29/32	112 4 ¹³ / ₃₂	50 1 ³¹ / ₃₂	46 1.811	M20 3/4
40 1 7/16 1 1/2 1 5/8	UKFL309D1;H2309X UKFL309D1;HA2309 UKFL309D1;HE2309X UKFL309D1;HS2309X	230 9 ¹ / ₁₆	177 6 ³¹ / ₃₂	25 63/64	18 23/32	44 1 ²³ / ₃₂	25 63/64	125 4 ²⁹ / ₃₂	54.5 2 ⁹ / ₆₄	50 1.969	M22 7/8
45 1 5/8 1 11/16 1 3/4	UKFL310D1;H2310X UKFL310D1;HS2310 UKFL310D1;HA2310 UKFL310D1;HE2310X	240 9 ⁷ / ₁₆	187 7 ²³ / ₆₄	28 1 ⁷ / ₆₄	19 3/4	48 1 ⁷ / ₈	25 63/64	140 5 ¹ / ₂	60.5 2 ³ / ₈	55 2.165	M22 7/8
50 1 7/8 1 9/16 2	UKFL311D1;H2311X UKFL311D1;HS2311 UKFL311D1;HA2311 UKFL311D1;HE2311XY	250 9 ²⁷ / ₃₂	198 7 ⁵¹ / ₆₄	30 1 ³ / ₁₆	20 25/32	52 2 ¹ / ₁₆	25 63/64	150 5 ²⁹ / ₃₂	64 2 ³³ / ₆₄	59 2.323	M22 7/8
55 2 1/8	UKFL312D1;H2312X UKFL312D1;HS2312	270 10 ⁵ / ₈	212 8 ¹¹ / ₃₂	33 1 ¹⁹ / ₆₄	22 7/8	56 2 ⁷ / ₃₂	31 1 ⁷ / ₃₂	160 6 ⁵ / ₁₆	69.5 2 ⁷ / ₆₄	62 2.441	M27 1

Notes ⁽¹⁾ These numbers indicate relubricatable type. If maintenance free type is needed, please order without suffix "D1".

⁽²⁾ Adapter number with suffix "X" means a narrow slot type adapter sleeve.

In this case the lock washer with the straight inner prong should be used.

⁽³⁾ For HE2311XY, screw thread pitch different from the standard is applied, because of the thin thread section of sleeve. To distinguish it, a suffix "Y" is added.

⁽⁴⁾ If the inch series housing units with dust cover are ordered with a closed end, the suffixes E, S or A are not included. Example: CM-UKFL305D1;HE2305

Remarks Please refer to page A21 for size of grease fitting.

Bearing number	Housing number	Unit number ⁽⁴⁾ cast dust cover type	Nominal dimensions				Mass of unit	
			t max.	A ₅	L ₁	L ₂	UKFL	C(CM)
UK305D1;H2305X UK305D1;HE2305	FL305D1 FL305D1	C(CM)-UKFL305D1;H2305X C(CM)-UKFL305ED1;HE2305	2 5/64	56 2 ⁷ / ₃₂	86 3 ³ / ₈	40 1 ⁹ / ₁₆	1.0 2.2	1.3 2.9
UK306D1;H2306X UK306D1;HS2306 UK306D1;HE2306X	FL306D1 FL306D1 FL306D1	C(CM)-UKFL306D1;H2306X C(CM)-UKFL306SD1;HS2306 C(CM)-UKFL306ED1;HE2306X	2 5/64	60 2 ³ / ₈	101 3 ³¹ / ₃₂	45 1 ²⁵ / ₃₂	1.5 3.3	1.8 4.0
UK307D1;H2307X UK307D1;HS2307	FL307D1 FL307D1	C(CM)-UKFL307D1;H2307X C(CM)-UKFL307SD1;HS2307	3 1/8	68 2 ¹¹ / ₁₆	110 4 ¹¹ / ₃₂	50 1 ³¹ / ₃₂	1.8 4.0	2.2 4.9
UK308D1;H2308X UK308D1;HE2308X UK308D1;HS2308X	FL308D1 FL308D1 FL308D1	C(CM)-UKFL308D1;H2308X C(CM)-UKFL308ED1;HE2308X C(CM)-UKFL308SD1;HS2308X	3 1/8	76 3	122 4 ¹³ / ₁₆	56 2 ⁷ / ₃₂	2.2 4.9	3.0 6.6
UK309D1;H2309X UK309D1;HA2309 UK309D1;HE2309X UK309D1;HS2309X	FL309D1 FL309D1 FL309D1 FL309D1	C(CM)-UKFL309D1;H2309X C(CM)-UKFL309AD1;HA2309 C(CM)-UKFL309ED1;HE2309X C(CM)-UKFL309SD1;HS2309X	3 1/8	80 3 ⁵ / ₃₂	135 5 ⁵ / ₁₆	62 2 ⁷ / ₁₆	3.0 6.6	3.9 8.6
UK310D1;H2310X UK310D1;HS2310 UK310D1;HA2310 UK310D1;HE2310X	FL310D1 FL310D1 FL310D1 FL310D1	C(CM)-UKFL310D1;H2310X C(CM)-UKFL310SD1;HS2310 C(CM)-UKFL310AD1;HA2310 C(CM)-UKFL310ED1;HE2310X	3 1/8	88 3 ¹⁵ / ₃₂	152 5 ³¹ / ₃₂	70 2 ³ / ₄	4.1 9.0	5.1 11
UK311D1;H2311X UK311D1;HS2311 UK311D1;HA2311 UK311D1;HE2311XY	FL311D1 FL311D1 FL311D1 FL311D1	C(CM)-UKFL311D1;H2311X C(CM)-UKFL311SD1;HS2311 C(CM)-UKFL311AD1;HA2311 C(CM)-UKFL311ED1;HE2311XY	4 5/32	92 3 ⁵ / ₈	162 6 ³ / ₈	75 2 ¹⁵ / ₁₆	4.6 10	6.0 13
UK312D1;H2312X UK312D1;HS2312	FL312D1 FL312D1	C(CM)-UKFL312D1;H2312X C(CM)-UKFL312SD1;HS2312	4 5/32	100 3 ¹⁵ / ₁₆	175 6 ⁷ / ₈	80 3 ⁵ / ₃₂	5.7 13	7.7 17

Rhombus flanged unit, cast housing Adapter type

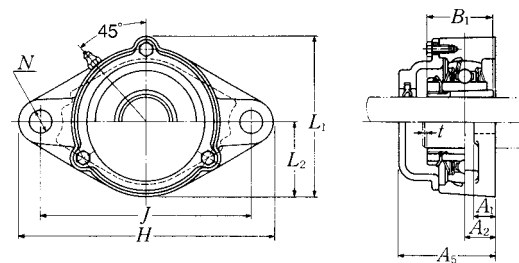
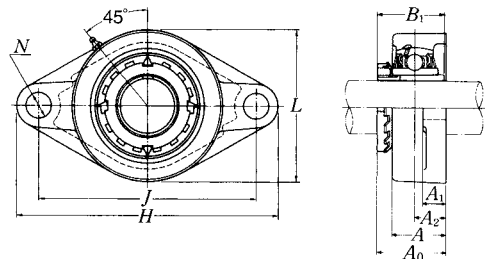

Cast dust cover type
Open end **C-UKFL...D1**
Closed end **CM-UKFL...D1**

Shaft dia. mm inch	Unit number ⁽¹⁾⁽²⁾	Nominal dimensions									Bolt size mm inch
		mm inch									
		H	J	A ₂	A ₁	A	N	L	A ₀	B ₁	
60 2 3/16 2 1/4 2 3/8	UKFL313D1;H2313X UKFL313D1;HA2313 UKFL313D1;HE2313X UKFL313D1;HS2313X	295 11 5/8	240 9 59/64	33 1 19/64	25 31/32	58 2 9/32	31 1 7/32	175 6 7/8	71.5 2 19/16	65 2.559	M27 1
65 2 7/16 2 1/2	UKFL315D1;H2315X UKFL315D1;HA2315 UKFL315D1;HE2315X	320 12 19/32	260 10 15/64	39 1 17/32	30 1 3/16	66 2 19/32	35 1 3/8	195 7 11/16	81.5 3 3/64	73 2.874	M30 1 1/8
70 2 11/16 2 3/4	UKFL316D1;H2316X UKFL316D1;HA2316 UKFL316D1;HE2316X	355 13 31/32	285 11 7/32	38 1 1/2	32 1 1/4	68 2 11/16	38 1 1/2	210 8 9/32	84 3 5/16	78 3.071	M33 1 1/4
75 2 15/16 3	UKFL317D1;H2317X UKFL317D1;HA2317X UKFL317D1;HE2317X	370 14 3/16	300 11 19/16	44 1 47/64	32 1 1/4	74 2 29/32	38 1 1/2	220 8 21/32	92 3 5/6	82 3.228	M33 1 1/4
80 3 3/16	UKFL318D1;H2318X UKFL318D1;HA2318X	385 15 5/32	315 12 13/32	44 1 47/64	36 1 13/32	76 3	38 1 1/2	235 9 1/4	94 3 45/64	86 3.386	M33 1 1/4
85 3 1/4	UKFL319D1;H2319X UKFL319D1;HE2319X	405 15 15/16	330 12 63/64	59 2 21/64	40 1 9/16	94 3 11/16	41 1 39/64	250 9 27/32	111.5 4 25/64	90 3.543	M36 1 3/8
90 3 7/16 3 1/2	UKFL320D1;H2320X UKFL320D1;HA2320 UKFL320D1;HE2320X	440 17 5/16	360 14 11/64	59 2 21/64	40 1 9/16	94 3 11/16	44 1 47/64	270 10 5/8	115.5 4 35/64	97 3.819	M39 1 1/2
100	UKFL322D1;H2322X	470	390	60	42	96	44	300	121	105	M39
110	UKFL324D1;H2324	520	430	65	48	110	47	330	130	112	M42
115	UKFL326D1;H2326	550	460	65	50	115	47	360	133	121	M42
125	UKFL328D1;H2328	600	500	75	60	125	51	400	146.5	131	M45

Notes ⁽¹⁾ These numbers indicate relubricatable type. If maintenance free type is needed, please order without suffix "D1".

⁽²⁾ Adapter number with suffix "X" means a narrow slot type adapter sleeve. In this case the lock washer with the straight inner prong should be used.

⁽³⁾ If the inch series housing units with dust cover are ordered with a closed end, the suffixes E, S or A are not included. Example: CM-UKFL305D1;HE2305

Remarks Please refer to page A21 for size of grease fitting.

Bearing number	Housing number	Unit number ⁽²⁾ cast dust cover type	Nominal dimensions				Mass of unit	
			t max.	A ₅	L ₁	L ₂	UKFL	C(CM)
				mm inch				kg lb
UK313D1;H2313X UK313D1;HA2313 UK313D1;HE2313X UK313D1;HS2313X	FL313D1 FL313D1 FL313D1 FL313D1	C(CM)-UKFL313D1;H2313X C(CM)-UKFL313AD1;HA2313 C(CM)-UKFL313ED1;HE2313X C(CM)-UKFL313SD1;HS2313X	4 5/32	103 4 1/16	189 7 7/16	88 3 15/32	7.4 16	9.8 22
UK315D1;H2315X UK315D1;HA2315 UK315D1;HE2315X	FL315D1 FL315D1 FL315D1	C(CM)-UKFL315D1;H2315X C(CM)-UKFL315AD1;HA2315 C(CM)-UKFL315ED1;HE2315X	4 5/32	114 4 1/2	210 8 9/32	98 3 27/32	9.9 22	13 29
UK316D1;H2316X UK316D1;HA2316 UK316D1;HE2316X	FL316D1 FL316D1 FL316D1	C(CM)-UKFL316D1;H2316X C(CM)-UKFL316AD1;HA2316 C(CM)-UKFL316ED1;HE2316X	4 5/32	116 4 9/16	222 8 3/4	105 4 1/8	13 29	17 37
UK317D1;H2317X UK317D1;HA2317X UK317D1;HE2317X	FL317D1 FL317D1 FL317D1	C(CM)-UKFL317D1;H2317X C(CM)-UKFL317AD1;HA2317X C(CM)-UKFL317ED1;HE2317X	5 13/64	127 5	234 9 7/32	110 4 11/32	15 33	18 40
UK318D1;H2318X UK318D1;HA2318X	FL318D1 FL318D1	C(CM)-UKFL318D1;H2318X C(CM)-UKFL318AD1;HA2318X	5 13/64	129 5 3/32	247 9 23/32	118 4 21/32	18 40	22 49
UK319D1;H2319X UK319D1;HE2319X	FL319D1 FL319D1	C(CM)-UKFL319D1;H2319X C(CM)-UKFL319ED1;HE2319X	5 13/64	149 5 7/8	260 10 1/4	125 4 29/32	22 49	27 60
UK320D1;H2320X UK320D1;HA2320 UK320D1;HE2320X	FL320D1 FL320D1 FL320D1	C(CM)-UKFL320D1;H2320X C(CM)-UKFL320AD1;HA2320 C(CM)-UKFL320ED1;HE2320X	5 13/64	154 6 1/16	280 11 1/32	135 5 5/16	26 57	32 71
UK322D1;H2322X	FL322D1	C(CM)-UKFL322D1;H2322X	5	160	315	150	34	41
UK324D1;H2324	FL324D1	C(CM)-UKFL324D1;H2324	5	172	342	165	47	52
UK326D1;H2326	FL326D1	C(CM)-UKFL326D1;H2326	6	178	376	180	58	65
UK328D1;H2328	FL328D1	C(CM)-UKFL328D1;H2328	6	192	410	200	82	90

Rhombus flanged unit, cast housing Adapter type

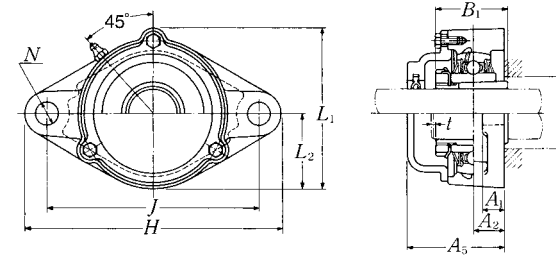
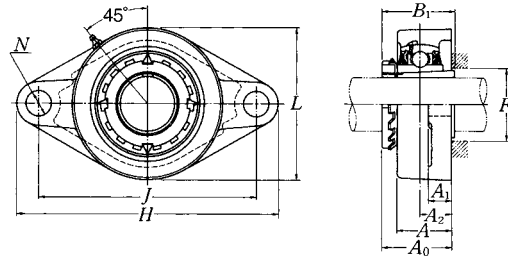

Cast dust cover type
Open end **C-UKFL...D1**
Closed end **CM-UKFL...D1**

Shaft dia. mm inch	Unit number ⁽¹⁾⁽²⁾	Nominal dimensions									
		H	J	A ₂	A ₁	A		N	L	A ₀	B ₁
		mm inch									
20 3/4	UKFLX05D1;H2305X UKFLX05D1;HE2305	141 5 9/16	117 4 39/64	18 45/64	13 1/2	30 1 3/16	12 15/32	83 3 9/32	39 1 17/32	35 1.378	-
25 7/8 1	UKFLX06D1;H2306X UKFLX06D1;HS2306 UKFLX06D1;HE2306X	156 6 5/32	130 5 1/8	19 3/4	15 19/32	34 1 11/32	16 5/8	95 3 3/4	41.5 1 41/64	38 1.496	-
30 1 1/8	UKFLX07D1;H2307X UKFLX07D1;HS2307	171 6 23/32	144 5 43/64	21 53/64	16 5/8	38 1 1/2	16 5/8	105 4 1/8	45.5 1 51/64	43 1.693	-
35 1 1/4 1 3/8	UKFLX08D1;H2308X UKFLX08D1;HE2308X UKFLX08D1;HS2308X	179 7 1/16	148 5 53/64	22 55/64	16 5/8	40 1 9/16	16 5/8	111 4 3/8	47.5 1 7/8	46 1.811	46 1 13/16
40 1 7/16 1 1/2 1 5/8	UKFLX09D1;H2309X UKFLX09D1;HA2309 UKFLX09D1;HE2309X UKFLX09D1;HS2309X	189 7 7/16	157 6 3/16	23 29/32	16 5/8	40 1 9/16	16 5/8	116 4 9/16	50 1 31/32	50 1.969	52 2 1/16
45 1 5/8 1 11/16 1 3/4	UKFLX10D1;H2310X UKFLX10D1;HS2310 UKFLX10D1;HA2310 UKFLX10D1;HE2310X	216 8 1/2	184 7 1/4	26 1 1/32	18 23/32	44 1 23/32	19 3/4	133 5 1/4	55.5 2 3/16	55 2.165	57 2 1/4

Notes ⁽¹⁾ These numbers indicate relubricatable type. If maintenance free type is needed, please order without suffix "D1".

⁽²⁾ Adapter number with suffix "X" means a narrow slot type adapter sleeve.

In this case the lock washer with the straight inner prong should be used.

⁽³⁾ If the inch series housing units with dust cover are ordered with a closed end, the suffixes E, S or A are not included.

Example: CM-UKFLX05D1;HE2305

Remarks Please refer to page A21 for size of grease fitting.

Bolt size mm inch	Bearing number	Housing number	Unit number ⁽²⁾ cast dust cover type	Nominal dimensions			Mass of unit		
				t	A ₅	L ₁	L ₂	UKF	C(CM)
				mm inch			kg lb		
M10 3/8	UKX05D1;H2305X UKX05D1;HE2305	FLX05D1 FLX05D1	C(CM)-UKFLX05D1;H2305X C(CM)-UKFLX05ED1;HE2305	2 5/64	56 2 7/32	86 3 3/8	41.5 1 5/8	1.0 2.2	1.2 2.7
M14 1/2	UKX06D1;H2306X UKX06D1;HS2306 UKX06D1;HE2306X	FLX06D1 FLX06D1 FLX06D1	C(CM)-UKFLX06D1;H2306X C(CM)-UKFLX06SD1;HS2306 C(CM)-UKFLX06ED1;HE2306X	2 5/64	59 2 5/16	98.5 3 7/8	47.5 1 7/8	1.4 3.1	1.6 3.5
M14 1/2	UKX07D1;H2307X UKX07D1;HS2307	FLX07D1 FLX07D1	C(CM)-UKFLX07D1;H2307X C(CM)-UKFLX07SD1;HS2307	3 1/8	66 2 19/32	108.5 4 9/32	52.5 2 1/16	1.8 4.0	2.2 4.9
M14 1/2	UKX08D1;H2308X UKX08D1;HE2308X UKX08D1;HS2308X	FLX08D1 FLX08D1 FLX08D1	C(CM)-UKFLX08D1;H2308X C(CM)-UKFLX08ED1;HE2308X C(CM)-UKFLX08SD1;HS2308X	3 1/8	70 2 3/4	114.5 4 1/4	55.5 2 3/16	2.2 4.9	2.6 5.7
M14 1/2	UKX09D1;H2309X UKX09D1;HA2309 UKX09D1;HE2309X UKX09D1;HS2309X	FLX09D1 FLX09D1 FLX09D1 FLX09D1	C(CM)-UKFLX09D1;H2309X C(CM)-UKFLX09AD1;HA2309 C(CM)-UKFLX09ED1;HE2309X C(CM)-UKFLX09SD1;HS2309X	3 1/8	73 2 7/8	119.5 4 23/32	58 2 9/32	2.2 4.9	2.7 6.0
M16 5/8	UKX10D1;H2310X UKX10D1;HS2310 UKX10D1;HA2310 UKX10D1;HE2310X	FLX10D1 FLX10D1 FLX10D1 FLX10D1	C(CM)-UKFLX10D1;H2310X C(CM)-UKFLX10SD1;HS2310 C(CM)-UKFLX10AD1;HA2310 C(CM)-UKFLX10ED1;HE2310X	3 1/8	76 3	133.5 5 1/4	66.5 2 5/8	3.1 6.8	3.6 7.9

Take-up unit, cast housing Adapter type

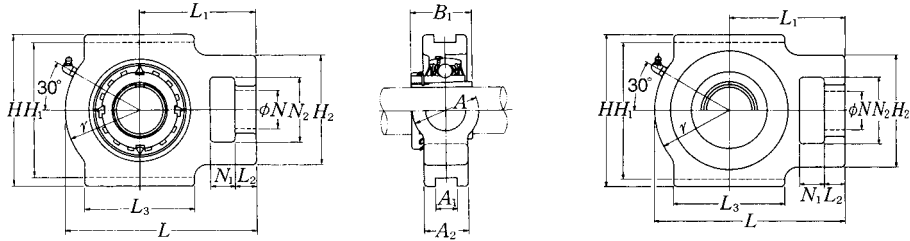

Pressed steel dust cover type
Open end **Z-UKT...D1**
Closed end **ZM-UKT...D1**

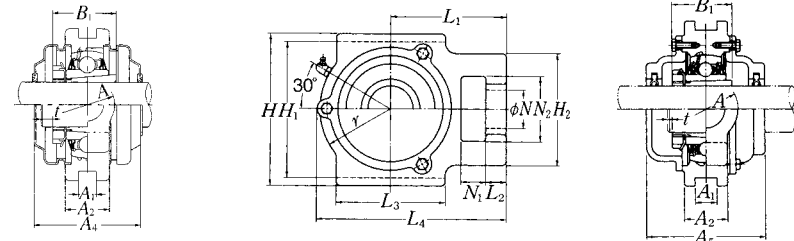

Cast dust cover type
Open end **C-UKT...D1**
Closed end **CM-UKT...D1**

Shaft dia. mm inch	Unit number ⁽¹⁾ ⁽²⁾ ⁽³⁾	Nominal dimensions														Bearing number	
		mm inch															
		N ₁	L ₂	H ₂	N ₂	N	L ₃	A ₁	H ₁	H	L	A ₂	A	r	L ₁		B ₁
20 3/4	UKT205D1;H2305X UKT205D1;HE2305	16 5/8	12 15/32	51 2	32 1/4	19 3/4	51 2	12 0.472	76 2 ³³ / ₆₄	89 3 1/2	97 3 ¹⁹ / ₁₆	24 15/16	32 1 1/4	35 1 1/8	62 2 7/16	35 1.378	UK205D1;H2305X UK205D1;HE2305
25 7/8	UKT206D1;H2306X UKT206D1;HS2306 UKT206D1;HE2306X	16 5/8	12 15/32	56 2 7/32	37 1 15/32	22 7/8	57 2 1/4	12 0.472	89 3 1/2	102 4 1/2	113 4 7/16	28 1 3/32	37 1 15/32	43 1 11/16	70 2 3/4	38 1.496	UK206D1;H2306X UK206D1;HS2306 UK206D1;HE2306X
30 1 1/8	UKT207D1;H2307X UKT207D1;HS2307	16 5/8	15 19/32	64 2 17/32	37 1 15/32	22 7/8	64 2 1/2	12 0.472	89 3 1/2	102 4 1/2	129 5 3/32	30 1 15/32	37 1 15/32	51 2	78 3 1/16	43 1.693	UK207D1;H2307X UK207D1;HS2307
35 1 1/4	UKT208D1;H2308X UKT208D1;HE2308X UKT208D1;HS2308X	19 3/4	18 23/32	83 3 9/32	49 1 15/16	29 1 5/32	83 3 9/32	16 0.630	102 4 1/4	114 4 1/2	144 5 21/32	33 1 5/16	49 1 15/16	56 2 7/32	88 3 15/32	46 1.811	UK208D1;H2308X UK208D1;HE2308X UK208D1;HS2308X
40 1 7/16	UKT209D1;H2309X UKT209D1;HA2309 UKT209D1;HE2309X UKT209D1;HS2309X	19 3/4	18 23/32	83 3 9/32	49 1 15/16	29 1 5/32	83 3 9/32	16 0.630	102 4 1/4	117 4 19/32	145 5 23/32	35 1 3/8	49 1 15/16	57 2 1/4	88 3 15/32	50 1.969	UK209D1;H2309X UK209D1;HA2309 UK209D1;HE2309X UK209D1;HS2309X
45 1 5/8	UKT210D1;H2310X UKT210D1;HS2310 UKT210D1;HA2310 UKT210D1;HE2310X	19 3/4	18 23/32	83 3 9/32	49 1 15/16	29 1 5/32	86 3 3/8	16 0.630	102 4 1/4	117 4 19/32	151 5 15/16	37 1 15/32	49 1 15/16	59 2 5/16	92 3 5/8	55 2.165	UK210D1;H2310X UK210D1;HS2310 UK210D1;HA2310 UK210D1;HE2310X
50 1 7/8	UKT211D1;H2311X UKT211D1;HS2311 UKT211D1;HA2311 UKT211D1;HE2311XY	25 3 1/2	21 13/16	102 4 1/32	64 2 17/32	35 1 3/8	95 3 3/4	22 0.866	130 5 1/8	146 5 3/4	171 6 23/32	38 1 1/2	64 2 17/32	65 2 9/16	106 4 3/16	59 2.323	UK211D1;H2311X UK211D1;HS2311 UK211D1;HA2311 UK211D1;HE2311XY
55 2 1/8	UKT212D1;H2312X UKT212D1;HS2312	32 1 1/4	21 13/16	102 4 1/32	64 2 17/32	35 1 3/8	102 4 1/32	22 0.866	130 5 1/8	146 5 3/4	194 7 5/8	42 1 21/32	64 2 17/32	75 2 15/16	119 4 11/16	62 2.441	UK212D1;H2312X UK212D1;HS2312

Notes ⁽¹⁾ These numbers indicate relubricatable type. If maintenance free type is needed, please order without suffix "D1".

⁽²⁾ Adapter number with suffix "X" means a narrow slot type adapter sleeve.

In this case the lock washer with the straight inner prong should be used.

⁽³⁾ For HE2311XY, screw thread pitch different from the standard is applied, because of the thin thread section of sleeve.

To distinguish it, a suffix "Y" is added.

Remarks Please refer to page A21 for size of grease fitting.

Housing number	Unit number pressed steel dust cover type	Unit number cast dust cover type	Nominal dimensions				Mass of unit		
			mm inch				kg lb		
			t max.	A ₄	L ₄	A ₅	UKT	Z(ZM)	C(CM)
T205D1	Z(ZM)-UKT205D1;H2305X	C(CM)-UKT205D1;H2305X	2 5/8	48 1 29/32	100.5 3 31/32	70 2 3/4	0.9 2.0	0.9 2.0	1.2 2.6
T206D1	Z(ZM)-UKT206D1;H2306X	C(CM)-UKT206D1;H2306X	2 5/64	53 2 3/32	113.5 4 15/32	75 2 15/16	1.3 2.9	1.4 3.1	1.8 4.0
T207D1	Z(ZM)-UKT207D1;H2307X	C(CM)-UKT207D1;H2307X	3 1/8	60 2 11/32	129 5 3/32	80 3 5/32	1.7 3.7	1.8 4.0	2.2 4.9
T208D1	Z(ZM)-UKT208D1;H2308X	C(CM)-UKT208D1;H2308X	3 1/8	69 2 23/32	144 5 21/32	90 3 17/32	2.5 5.5	2.6 5.7	3.3 7.3
T209D1	Z(ZM)-UKT209D1;H2309X	C(CM)-UKT209D1;H2309X	3 1/8	69 2 23/32	145.5 5 23/32	95 3 3/4	2.5 5.5	2.6 5.7	3.5 7.7
T210D1	Z(ZM)-UKT210D1;H2310X	C(CM)-UKT210D1;H2310X	3 1/8	76 3	152 5 31/32	100 3 15/16	2.7 6.0	2.8 6.2	3.8 8.4
T211D1	Z(ZM)-UKT211D1;H2311X	C(CM)-UKT211D1;H2311X	4 5/32	77 3 3/32	171.5 6 3/4	100 3 15/16	4.1 9.0	4.3 9.5	5.3 12
T212D1	Z(ZM)-UKT212D1;H2312X	C(CM)-UKT212D1;H2312X	4 5/32	89 3 1/2	194 7 5/8	115 4 11/32	4.9 11	5.2 11	6.3 14

Take-up unit, cast housing Adapter type

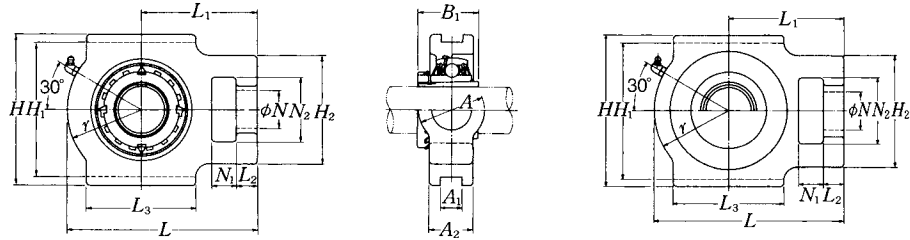

Pressed steel dust cover type
Open end **Z-UKT...D1**
Closed end **ZM-UKT...D1**

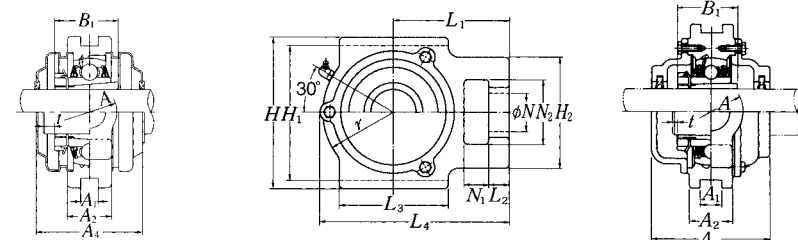

Cast dust cover type
Open end **C-UKT...D1**
Closed end **CM-UKT...D1**

Shaft dia. mm inch	Unit number ⁽¹⁾⁽²⁾	Nominal dimensions														Bearing number	
		mm inch															
		N_1	L_2	H_2	N_2	N	L_3	A_1	H_1	H	L	A_2	A	r	L_1		B_1
60 2 3/16 2 1/4 2 3/8	UKT213D1;H2313X UKT213D1;HA2313 UKT213D1;HE2313X UKT213D1;HS2313X	32	23	111	70	41	121	26	151	167	224	44	70	87	137	65	UK213D1;H2313X UK213D1;HA2313 UK213D1;HE2313X UK213D1;HS2313X
65 2 7/16 2 1/2	UKT215D1;H2315X UKT215D1;HA2315 UKT215D1;HE2315X	32	23	111	70	41	121	26	151	167	232	48	70	92	140	73	UK215D1;H2315X UK215D1;HA2315 UK215D1;HE2315X
70 2 11/16 2 3/4	UKT216D1;H2316X UKT216D1;HA2316 UKT216D1;HE2316X	32	23	111	70	41	121	26	165	184	235	51	70	95	140	78	UK216D1;H2316X UK216D1;HA2316 UK216D1;HE2316X
75 2 15/16 3	UKT217D1;H2317X UKT217D1;HA2317X UKT217D1;HE2317X	38	31	124	73	48	157	30	173	198	260	54	73	98	162	82	UK217D1;H2317X UK217D1;HA2317X UK217D1;HE2317X

Notes ⁽¹⁾ These numbers indicate relubricatable type. If maintenance free type is needed, please order without suffix "D1".
⁽²⁾ Adapter number with suffix "X" means a narrow slot type adapter sleeve.
In this case the lock washer with the straight inner prong should be used.
Remarks Please refer to page A21 for size of grease fitting.

Housing number	Unit number pressed steel dust cover type	Unit number cast dust cover type	Nominal dimensions				Mass of unit		
			mm inch				kg lb		
			t max.	A_4	L_4	A_5	UKT	Z(ZM)	C(CM)
T213D1	Z(ZM)-UKT213D1;H2313X	C(CM)-UKT213D1;H2313X	4	91	224	120	7.1	7.4	8.8
T213D1	Z(ZM)-UKT213AD1;HA2313	C(CM)-UKT213AD1;HA2313	5/32	3 19/32	8 13/16	4 23/32	16	16	19
T213D1	Z(ZM)-UKT213ED1;HE2313X	C(CM)-UKT213ED1;HE2313X	5/32	3 19/32	8 13/16	4 23/32	16	16	19
T213D1	Z(ZM)-UKT213SD1;HS2313X	C(CM)-UKT213SD1;HS2313X	5/32	3 19/32	8 13/16	4 23/32	16	16	19
T215D1	—	C(CM)-UKT215D1;H2315X	4	—	232	135	7.7	—	10
T215D1	—	C(CM)-UKT215AD1;HA2315	5/32	—	9 1/8	5 5/16	17	—	22
T215D1	—	C(CM)-UKT215ED1;HE2315X	5/32	—	9 1/8	5 5/16	17	—	22
T216D1	—	C(CM)-UKT216D1;H2316X	4	—	235	145	8.7	—	12
T216D1	—	C(CM)-UKT216AD1;HA2316	5/32	—	9 1/4	5 23/32	19	—	26
T216D1	—	C(CM)-UKT216ED1;HE2316X	5/32	—	9 1/4	5 23/32	19	—	26
T217D1	—	C(CM)-UKT217D1;H2317X	5	—	260	155	11	—	15
T217D1	—	C(CM)-UKT217AD1;HA2317X	13/64	—	10 1/4	6 3/32	24	—	33
T217D1	—	C(CM)-UKT217ED1;HE2317X	13/64	—	10 1/4	6 3/32	24	—	33

Take-up unit, cast housing Adapter type

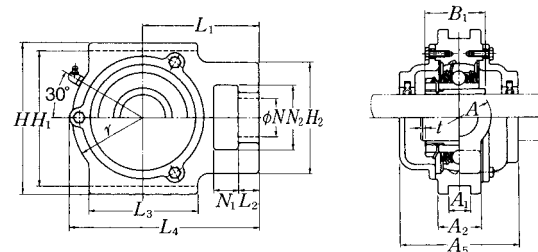
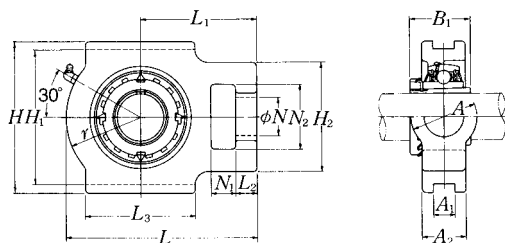

Cast dust cover type
Open end **C-UKT...D1**
Closed end **CM-UKT...D1**

Shaft dia. mm inch	Unit number ⁽¹⁾ ⁽²⁾ ⁽³⁾	Nominal dimensions														
		mm inch														
		N_1	L_2	H_2	N_2	N	L_3	A_1	H_1	H	L	A_2	A	r	L_1	B_1
20 3/4	UKT305D1;H2305X UKT305D1;HE2305	16 5/8	14 9/16	62 2 7/16	36 1 13/32	26 1 1/2	65 2 9/16	12 0.472	80 2 5/32	89 3 1/2	122 4 13/16	26 1 1/2	36 1 13/32	46 1 13/16	76 3	35 1.378
25 7/8 1	UKT306D1;H2306X UKT306D1;HS2306 UKT306D1;HE2306X	18 23/32	16 5/8	70 2 3/4	41 1 5/8	28 1 3/32	74 2 29/32	16 0.630	90 3 35/64	100 3 15/16	137 5 13/32	28 1 3/32	41 1 5/8	52 2 1/16	85 3 11/32	38 1.496
30 1 1/8	UKT307D1;H2307X UKT307D1;HS2307	20 25/32	17 21/32	75 2 15/16	45 1 25/32	30 1 3/16	80 3 5/32	16 0.630	100 3 15/16	111 4 3/8	150 5 29/32	32 1 1/4	45 1 25/32	56 2 7/32	94 3 11/16	43 1.693
35 1 1/4 1 3/8	UKT308D1;H2308X UKT308D1;HE2308X UKT308D1;HS2308X	22 7/8	19 3/4	83 3 3/8	50 1 31/32	32 1 1/4	89 3 1/2	18 0.709	112 4 13/32	124 4 7/8	162 6 3/8	34 1 11/32	50 1 31/32	62 2 7/16	100 3 15/16	46 1.811
40 1 7/16 1 1/2 1 5/8	UKT309D1;H2309X UKT309D1;HA2309 UKT309D1;HE2309X UKT309D1;HS2309X	24 15/16	20 25/32	90 3 17/32	55 2 5/32	34 1 11/32	97 3 13/16	18 0.709	125 4 59/64	138 5 7/16	178 7	38 1 1/2	55 2 5/32	68 2 11/16	110 4 11/32	50 1.969
45 1 5/8 1 11/16 1 3/4	UKT310D1;H2310X UKT310D1;HS2310 UKT310D1;HA2310 UKT310D1;HE2310X	27 1 1/16	22 7/8	98 3 27/32	61 2 13/32	37 1 15/32	106 4 3/16	20 0.787	140 5 33/64	151 5 15/16	192 7 9/16	40 1 9/16	61 2 13/32	74 2 29/32	118 4 21/32	55 2.165
50 1 7/8 1 15/16 2	UKT311D1;H2311X UKT311D1;HS2311 UKT311D1;HA2311 UKT311D1;HE2311XY	29 1 5/32	23 29/32	105 4 1/8	66 2 19/32	39 1 17/32	115 4 17/32	22 0.866	150 5 29/32	163 6 13/32	207 8 5/32	44 1 23/32	66 2 19/32	80 3 5/32	127 5	59 2.323
55 2 1/8	UKT312D1;H2312X UKT312D1;HS2312	31 1 1/32	25 31/32	113 4 1/16	71 2 25/32	41 1 5/8	123 4 27/32	22 0.866	160 6 19/64	178 7	220 8 21/32	46 1 13/16	71 2 25/32	85 3 11/32	135 5 5/16	62 2.441

Notes ⁽¹⁾ These numbers indicate relubricatable type. If maintenance free type is needed, please order without suffix "D1".

⁽²⁾ Adapter number with suffix "X" means a narrow slot type adapter sleeve.

In this case the lock washer with the straight inner prong should be used.

⁽³⁾ For HE2311XY, screw thread pitch different from the standard is applied, because of the thin thread section of sleeve.

To distinguish it, a suffix "Y" is added.

Remarks Please refer to page A21 for size of grease fitting.

Bearing number	Housing number	Unit number cast dust cover type	Nominal dimensions			Mass of unit	
			mm inch			kg lb	
			t max.	L_4	A_5	UKT	C(CM)
UK305D1;H2305X UK305D1;HE2305	T305D1 T305D1	C(CM)-UKT305D1;H2305X C(CM)-UKT305ED1;HE2305	2 5/64	122 4 13/16	80 3 5/32	1.4 3.1	1.9 4.2
UK306D1;H2306X UK306D1;HS2306 UK306D1;HE2306X	T306D1 T306D1 T306D1	C(CM)-UKT306D1;H2306X C(CM)-UKT306SD1;HS2306 C(CM)-UKT306ED1;HE2306X	2 5/64	139 5 31/32	85 3 11/32	1.8 4.0	2.5 5.5
UK307D1;H2307X UK307D1;HS2307	T307D1 T307D1	C(CM)-UKT307D1;H2307X C(CM)-UKT307SD1;HS2307	3 1/8	152 5 31/32	95 3 3/4	2.4 5.3	3.3 7.3
UK308D1;H2308X UK308D1;HE2308X UK308D1;HS2308X	T308D1 T308D1 T308D1	C(CM)-UKT308D1;H2308X C(CM)-UKT308ED1;HE2308X C(CM)-UKT308SD1;HS2308X	3 1/8	164 6 15/32	105 4 1/8	3.0 6.6	4.3 9.5
UK309D1;H2309X UK309D1;HA2309 UK309D1;HE2309X UK309D1;HS2309X	T309D1 T309D1 T309D1 T309D1	C(CM)-UKT309D1;H2309X C(CM)-UKT309AD1;HA2309 C(CM)-UKT309ED1;HE2309X C(CM)-UKT309SD1;HS2309X	3 1/8	181 7 1/8	110 4 11/32	4.0 8.8	5.6 12
UK310D1;H2310X UK310D1;HS2310 UK310D1;HA2310 UK310D1;HE2310X	T310D1 T310D1 T310D1 T310D1	C(CM)-UKT310D1;H2310X C(CM)-UKT310SD1;HS2310 C(CM)-UKT310AD1;HA2310 C(CM)-UKT310ED1;HE2310X	3 1/8	197 7 3/4	120 4 23/32	5.1 11	7.1 16
UK311D1;H2311X UK311D1;HS2311 UK311D1;HA2311 UK311D1;HE2311XY	T311D1 T311D1 T311D1 T311D1	C(CM)-UKT311D1;H2311X C(CM)-UKT311SD1;HS2311 C(CM)-UKT311AD1;HA2311 C(CM)-UKT311ED1;HE2311XY	4 5/32	211 8 5/16	125 4 29/32	6.3 14	8.6 19
UK312D1;H2312X UK312D1;HS2312	T312D1 T312D1	C(CM)-UKT312D1;H2312X C(CM)-UKT312SD1;HS2312	4 5/32	227 8 15/16	135 5 5/16	7.6 17	10 22

Take-up unit, cast housing Adapter type

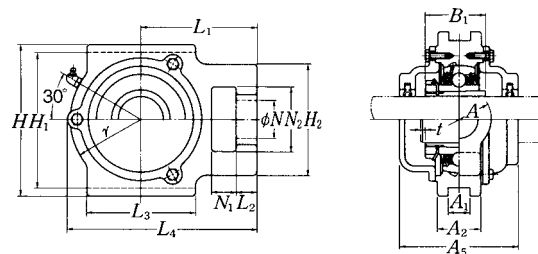
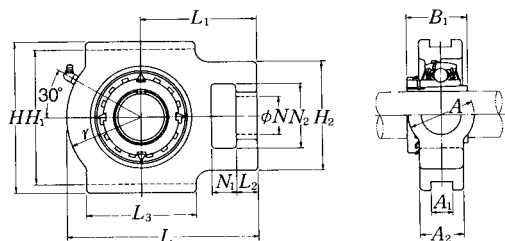

Cast dust cover type
Open end **C-UKT...D1**
Closed end **CM-UKT...D1**

Shaft dia. mm inch	Unit number ⁽¹⁾⁽²⁾	Nominal dimensions														
		mm inch														
		N_1	L_2	H_2	N_2	N	L_3	A_1	H_1	H	L	A_2	A	r	L_1	B_1
60 2 3/16 2 1/4 2 3/8	UKT313D1;H2313X UKT313D1;HA2313 UKT313D1;HE2313X UKT313D1;HS2313X	32	27	116	70	43	134	26	170	190	238	50	80	92	146	65
		1 1/4	1 1/16	4 3/16	2 3/4	1 11/16	5 9/32	1.024	6 11/16	7 15/32	9 3/8	1 31/32	3 5/32	3 5/8	5 3/4	2.559
65 2 7/16 2 1/2	UKT315D1;H2315X UKT315D1;HA2315 UKT315D1;HE2315X	36	27	132	85	46	150	26	192	216	262	55	90	102	160	73
		1 13/32	1 1/16	5 3/16	3 11/32	1 13/16	5 29/32	1.024	7 9/16	8 1/2	10 5/16	2 5/32	3 17/32	4 1/32	6 5/16	2.874
70 2 11/16 2 3/4	UKT316D1;H2316X UKT316D1;HA2316 UKT316D1;HE2316X	42	30	150	98	53	160	30	204	230	282	60	102	108	174	78
		1 21/32	1 3/16	5 29/32	3 27/32	2 3/32	6 5/16	1.181	8 1/32	9 1/16	11 3/32	2 3/8	4 1/32	4 1/4	6 27/32	3.071
75 2 15/16 3	UKT317D1;H2317X UKT317D1;HA2317X UKT317D1;HE2317X	42	32	152	98	53	170	32	214	240	298	64	102	115	183	82
		1 21/32	1 1/4	5 31/32	3 27/32	2 3/32	6 11/16	1.260	8 27/64	9 7/16	11 23/32	2 17/32	4 1/32	4 17/32	7 7/32	3.228
80 3 3/16	UKT318D1;H2318X UKT318D1;HA2318X	46	32	160	106	57	175	32	228	255	312	66	110	120	192	86
		1 13/16	1 1/4	6 5/16	4 3/16	2 1/4	6 7/8	1.260	8 31/32	10 1/32	12 3/32	2 19/32	4 11/32	4 23/32	7 9/16	3.386
85 3 1/4	UKT319D1;H2319X UKT319D1;HE2319X	46	33	165	106	57	180	35	240	270	322	72	110	125	197	90
		1 13/16	1 5/16	6 1/2	4 3/16	2 1/4	7 3/32	1.378	9 29/64	10 5/8	12 11/16	2 27/32	4 11/32	4 29/32	7 3/4	3.543
90 3 7/16 3 1/2	UKT320D1;H2320X UKT320D1;HA2320 UKT320D1;HE2320X	48	34	175	115	59	200	35	260	290	345	75	120	135	210	97
		1 7/8	1 11/32	6 7/8	4 17/32	2 5/16	7 7/8	1.378	10 15/64	11 11/32	13 19/32	2 15/16	4 23/32	5 5/16	8 9/32	3.819
100	UKT322D1;H2322X	52	40	185	125	65	215	38	285	320	385	80	130	150	235	105
110	UKT324D1;H2324	60	44	210	140	70	230	45	320	355	432	90	140	165	267	112
115	UKT326D1;H2326	65	47	220	150	75	240	50	350	385	465	100	150	180	285	121
125	UKT328D1;H2328	70	52	230	160	80	255	50	380	415	515	100	155	200	315	131

Notes ⁽¹⁾ These numbers indicate relubricatable type. If maintenance free type is needed, please order without suffix "D1".

⁽²⁾ Adapter number with suffix "X" means a narrow slot type adapter sleeve.
In this case the lock washer with the straight inner prong should be used.

Remarks Please refer to page A21 for size of grease fitting.

Bearing number	Housing number	Unit number cast dust cover type	Nominal dimensions			Mass of unit	
			mm inch			kg lb	
			t max.	L_4	A_5	UKT	C(CM)
UK313D1;H2313X	T313D1	C(CM)-UKT313D1;H2313X	4	244	140	9.2	12
UK313D1;HA2313	T313D1	C(CM)-UKT313AD1;HA2313	5/32	9 9/32	5 1/2	20	26
UK313D1;HE2313X	T313D1	C(CM)-UKT313ED1;HE2313X					
UK313D1;HS2313X	T313D1	C(CM)-UKT313SD1;HS2313X					
UK315D1;H2315X	T315D1	C(CM)-UKT315D1;H2315X	4	268	150	13	17
UK315D1;HA2315	T315D1	C(CM)-UKT315AD1;HA2315	5/32	10 9/16	5 29/32	29	37
UK315D1;HE2315X	T315D1	C(CM)-UKT315ED1;HE2315X					
UK316D1;H2316X	T316D1	C(CM)-UKT316D1;H2316X	4	287	155	16	21
UK316D1;HA2316	T316D1	C(CM)-UKT316AD1;HA2316	5/32	11 5/16	6 3/32	35	46
UK316D1;HE2316X	T316D1	C(CM)-UKT316ED1;HE2316X					
UK317D1;H2317X	T317D1	C(CM)-UKT317D1;H2317X	5	303	170	19	25
UK317D1;HA2317X	T317D1	C(CM)-UKT317AD1;HA2317X	13/64	11 15/16	6 11/16	42	55
UK317D1;HE2317X	T317D1	C(CM)-UKT317ED1;HE2317X					
UK318D1;H2318X	T318D1	C(CM)-UKT318D1;H2318X	5	317	170	21	28
UK318D1;HA2318X	T318D1	C(CM)-UKT318AD1;HA2318X	13/64	12 15/32	6 11/16	46	62
UK319D1;H2319X	T319D1	C(CM)-UKT319D1;H2319X	5	327	180	25	32
UK319D1;HE2319X	T319D1	C(CM)-UKT319ED1;HE2319X	13/64	12 7/8	7 3/32	55	71
UK320D1;H2320X	T320D1	C(CM)-UKT320D1;H2320X	5	350	190	30	39
UK320D1;HA2320	T320D1	C(CM)-UKT320AD1;HA2320	13/64	13 25/32	7 15/32	66	86
UK320D1;HE2320X	T320D1	C(CM)-UKT320ED1;HE2320X					
UK322D1;H2322X	T322D1	C(CM)-UKT322D1;H2322X	5	395	200	40	51
UK324D1;H2324	T324D1	C(CM)-UKT324D1;H2324	5	439	215	43	69
UK326D1;H2326	T326D1	C(CM)-UKT326D1;H2326	6	476	225	69	85
UK328D1;H2328	T328D1	C(CM)-UKT328D1;H2328	6	519	235	88	107

Take-up unit, cast housing Adapter type

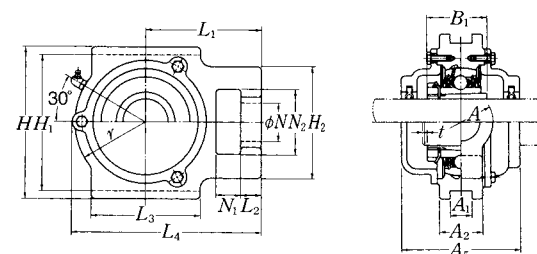
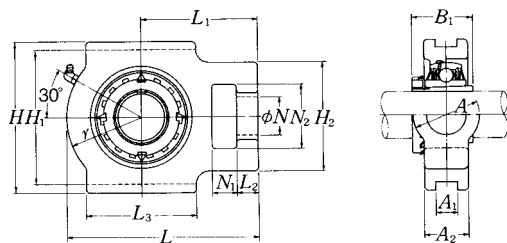

Cast dust cover type
Open end **C-UKT...D1**
Closed end **CM-UKT...D1**

Shaft dia. mm inch	Unit number ⁽¹⁾ ⁽²⁾ ⁽³⁾	Nominal dimensions														
		mm inch														
		N ₁	L ₂	H ₂	N ₂	N	L ₃	A ₁	H ₁	H	L	A ₂	A	r	L ₁	B ₁
20 3/4	UKTX05D1;H2305X UKTX05D1;HE2305	16 5/8	12 15/32	56 2 7/32	37 1 15/32	22 7/8	27 2 1/4	12 0.472	89 3 1/2	102 4 1/4	113 4 7/16	28 1 3/32	37 1 15/32	43 1 11/16	70 2 3/4	35 1.378
25 7/8 1	UKTX06D1;H2306X UKTX06D1;HS2306 UKTX06D1;HE2306X	16 5/8	15 19/32	64 2 17/32	37 1 15/32	22 7/8	64 2 17/32	12 0.472	89 3 1/2	102 4 1/4	129 5 3/32	30 1 3/16	37 1 15/32	51 2	78 3 1/16	38 1.496
30 1 1/8	UKTX07D1;H2307X UKTX07D1;HS2307	19 3/4	17 21/32	83 3 9/32	49 1 15/16	29 1 5/32	83 3 9/32	16 0.630	102 4 1/4	114 4 1/2	144 5 21/32	36 1 19/32	49 1 15/16	56 2 7/32	88 3 15/32	43 1.693
35 1 1/4 1 3/8	UKTX08D1;H2308X UKTX08D1;HE2308X UKTX08D1;HS2308X	19 3/4	17 21/32	83 3 9/32	49 1 15/16	29 1 5/32	83 3 9/32	16 0.630	102 4 1/4	117 4 19/32	144 5 21/32	36 1 19/32	49 1 15/16	57 2 1/4	87 3 7/16	46 1.811
40 1 7/16 1 1/2 1 5/8	UKTX09D1;H2309X UKTX09D1;HA2309 UKTX09D1;HE2309X UKTX09D1;HS2309X	19 3/4	18 23/32	83 3 9/32	49 1 15/16	29 1 5/32	86 3 3/8	16 0.630	102 4 1/4	117 4 19/32	151 5 15/16	38 1 1/2	49 1 15/16	59 2 5/16	92 3 5/8	50 1.969
45 1 5/8 1 11/16 1 3/4	UKTX10D1;H2310X UKTX10D1;HS2310 UKTX10D1;HA2310 UKTX10D1;HE2310X	25 3 1/2	21 13/16	102 4 1/2	64 2 17/32	35 1 3/8	95 3 3/4	22 0.866	130 5 1/8	146 5 3/4	171 6 23/32	42 1 21/32	64 2 17/32	65 2 9/16	106 4 3/16	55 2.165
50 1 7/8 1 15/16 2	UKTX11D1;H2311X UKTX11D1;HS2311 UKTX11D1;HA2311 UKTX11D1;HE2311XY	32 1 1/4	21 13/16	102 4 1/2	64 2 17/32	35 1 3/8	102 4 1/2	22 0.866	130 5 1/8	146 5 3/4	194 7 5/8	44 1 23/32	64 2 17/32	75 2 15/16	119 4 11/16	59 2.323
55 2 1/8	UKTX12D1;H2312X UKTX12D1;HS2312	32 1 1/4	23 29/32	111 4 3/8	70 2 3/4	41 1 5/8	121 4 3/4	26 1.024	151 5 15/16	167 6 9/16	224 8 13/16	48 1 7/8	70 2 3/4	87 3 7/16	137 5 13/32	62 2.441

Notes ⁽¹⁾ These numbers indicate relubricatable type. If maintenance free type is needed, please order without suffix "D1".

⁽²⁾ Adapter number with suffix "X" means a narrow slot type adapter sleeve.

In this case the lock washer with the straight inner prong should be used.

⁽³⁾ For HE2311XY, screw thread pitch different from the standard is applied, because of the thin thread section of sleeve.

To distinguish it, a suffix "Y" is added.

Remarks Please refer to page A21 for size of grease fitting.

Bearing number	Housing number	Unit number cast dust cover type	Nominal dimensions			Mass of unit	
			mm inch			kg lb	
			t max.	L ₄	A ₅	UKT	C(CM)
UKX05D1;H2305X UKX05D1;HE2305	TX05D1 TX05D1	C(CM)-UKTX05D1;H2305X C(CM)-UKTX05ED1;HE2305	2 5/64	113.5 4 15/32	75 2 15/16	1.3 2.9	1.8 4.0
UKX06D1;H2306X UKX06D1;HS2306 UKX06D1;HE2306X	TX06D1 TX06D1 TX06D1	C(CM)-UKTX06D1;H2306X C(CM)-UKTX06SD1;HS2306 C(CM)-UKTX06ED1;HE2306X	2 5/64	129 5 3/32	80 3 5/32	1.7 3.7	2.2 4.9
UKX07D1;H2307X UKX07D1;HS2307	TX07D1 TX07D1	C(CM)-UKTX07D1;H2307X C(CM)-UKTX07SD1;HS2307	3 1/8	144 5 21/32	90 3 17/32	2.7 6.0	3.5 7.7
UKX08D1;H2308X UKX08D1;HE2308X UKX08D1;HS2308X	TX08D1 TX08D1 TX08D1	C(CM)-UKTX08D1;H2308X C(CM)-UKTX08ED1;HE2308X C(CM)-UKTX08SD1;HS2308X	3 1/8	144.5 5 11/16	95 3 3/4	2.8 6.2	3.7 8.2
UKX09D1;H2309X UKX09D1;HA2309 UKX09D1;HE2309X UKX09D1;HS2309X	TX09D1 TX09D1 TX09D1 TX09D1	C(CM)-UKTX09D1;H2309X C(CM)-UKTX09AD1;HA2309 C(CM)-UKTX09ED1;HE2309X C(CM)-UKTX09SD1;HS2309X	3 1/8	152 5 31/32	100 3 15/16	2.7 6.0	3.8 8.4
UKX10D1;H2310X UKX10D1;HS2310 UKX10D1;HA2310 UKX10D1;HE2310X	TX10D1 TX10D1 TX10D1 TX10D1	C(CM)-UKTX10D1;H2310X C(CM)-UKTX10SD1;HS2310 C(CM)-UKTX10AD1;HA2310 C(CM)-UKTX10ED1;HE2310X	3 1/8	171.5 6 3/4	100 3 15/16	4.3 9.5	5.5 12
UKX11D1;H2311X UKX11D1;HS2311 UKX11D1;HA2311 UKX11D1;HE2311XY	TX11D1 TX11D1 TX11D1 TX11D1	C(CM)-UKTX11D1;H2311X C(CM)-UKTX11SD1;HS2311 C(CM)-UKTX11AD1;HA2311 C(CM)-UKTX11ED1;HE2311XY	4 5/32	194 7 5/8	115 4 17/32	5.1 11	6.6 15
UKX12D1;H2312X UKX12D1;HS2312	TX12D1 TX12D1	C(CM)-UKTX12D1;H2312X C(CM)-UKTX12SD1;HS2312	4 5/32	224 8 13/16	120 4 23/32	7.2 16	9.0 20

Take-up unit, cast housing Adapter type

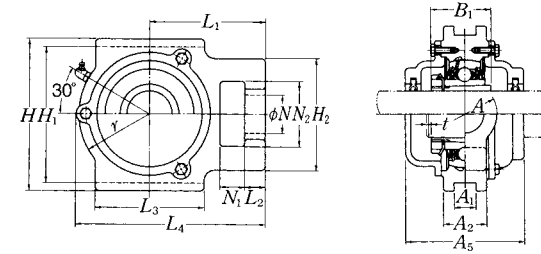
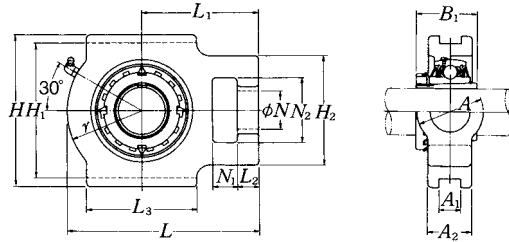

Cast dust cover type
Open end **C-UKT...D1**
Closed end **CM-UKT...D1**

Shaft dia. mm inch	Unit number ⁽¹⁾⁽²⁾	Nominal dimensions														
		mm inch														
		N_1	L_2	H_2	N_2	N	L_3	A_1	H_1	H	L	A_2	A	r	L_1	B_1
60 2 3/16 2 1/4 2 3/8	UKTX13D1;H2313X UKTX13D1;HA2313 UKTX13D1;HE2313X UKTX13D1;HS2313X	32	23	111	70	41	121	26	151	167	224	48	70	87	137	65
		1 1/4	29/32	4 3/8	2 3/4	1 5/8	4 3/4	1.024	5 15/16	6 9/16	8 13/16	1 7/8	2 3/4	3 7/16	5 13/32	2.559
65 2 7/16 2 1/2	UKTX15D1;H2315X UKTX15D1;HA2315 UKTX15D1;HE2315X	32	23	111	70	41	121	28	165	184	235	48	70	95	140	73
		1 1/4	29/32	4 3/8	2 3/4	1 5/8	4 3/4	1.102	6 1/2	7 1/4	9 1/4	1 7/8	2 3/4	3 3/4	5 1/2	2.874
70 2 11/16 2 3/4	UKTX16D1;H2316X UKTX16D1;HA2316 UKTX16D1;HE2316X	38	30	124	73	48	157	28	173	198	260	54	73	98	162	78
		1 1/2	1 3/16	4 7/8	2 7/8	1 7/8	6 3/16	1.102	6 13/16	7 25/32	10 1/4	2 1/8	2 7/8	3 27/32	6 3/8	3.071
75 2 15/16 3	UKTX17D1;H2317X UKTX17D1;HA2317X UKTX17D1;HE2317X	38	30	124	73	48	157	28	173	198	260	54	73	98	162	82
		1 1/2	1 3/16	4 7/8	2 7/8	1 7/8	6 3/16	1.102	6 13/16	7 25/32	10 1/4	2 1/8	2 7/8	3 27/32	6 3/8	3.228

Notes ⁽¹⁾ These numbers indicate relubricatable type. If maintenance free type is needed, please order without suffix "D1".

⁽²⁾ Adapter number with suffix "X" means a narrow slot type adapter sleeve.
In this case the lock washer with the straight inner prong should be used.

Remarks Please refer to page A21 for size of grease fitting.

Bearing number	Housing number	Unit number cast dust cover type	Nominal dimensions			Mass of unit	
			mm inch			kg lb	
			t max.	L_4	A_5	UKT	C(CM)
UKX13D1;H2313X UKX13D1;HA2313 UKX13D1;HE2313X UKX13D1;HS2313X	TX13D1 TX13D1 TX13D1 TX13D1	C(CM)-UKTX13D1;H2313X C(CM)-UKTX13AD1;HA2313 C(CM)-UKTX13ED1;HE2313X C(CM)-UKTX13SD1;HS2313X	4 5/32	224 8 13/16	135 5 5/16	7.2 16	9.5 21
UKX15D1;H2315X UKX15D1;HA2315 UKX15D1;HE2315X	TX15D1 TX15D1 TX15D1	C(CM)-UKTX15D1;H2315X C(CM)-UKTX15AD1;HA2315 C(CM)-UKTX15ED1;HE2315X	4 5/32	235 9 1/4	145 5 23/32	8.5 19	11 24
UKX16D1;H2316X UKX16D1;HA2316 UKX16D1;HE2316X	TX16D1 TX16D1 TX16D1	C(CM)-UKTX16D1;H2316X C(CM)-UKTX16AD1;HA2316 C(CM)-UKTX16ED1;HE2316X	4 5/32	260 10 1/4	155 6 3/32	11 24	14 31
UKX17D1;H2317X UKX17D1;HA2317X UKX17D1;HE2317X	TX17D1 TX17D1 TX17D1	C(CM)-UKTX17D1;H2317X C(CM)-UKTX17AD1;HA2317X C(CM)-UKTX17ED1;HE2317X	5 13/64	262 10 5/16	165 6 1/2	11 24	15 33

Cartridge unit, cast housing Adapter type

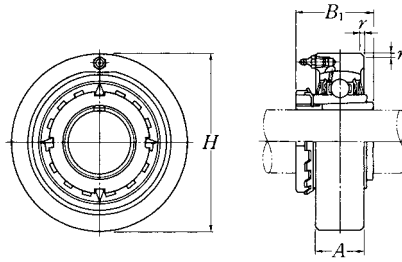

Shaft dia. mm inch	Unit number ⁽¹⁾ / ₍₂₎ / ₍₃₎	Nominal dimensions				Bearing number	Housing number	Mass of unit kg lb
		mm inch						
		H	A	r	B ₁			
20 3/4	UKC205D1;H2305X	80	22	2	35	UK205D1;H2305X	C205D1	0.7
	UKC205D1;HE2305	3.1496	55/64	0.079	1.378	UK205D1;HE2305	C205D1	1.5
25 7/8 1	UKC206D1;H2306X	85	27	2	38	UK206D1;H2306X	C206D1	0.9
	UKC206D1;HS2306 UKC206D1;HE2306X	3.3465	1 1/16	0.079	1.496	UK206D1;HS2306 UK206D1;HE2306X	C206D1 C206D1	2.0
30 1 1/8	UKC207D1;H2307X	90	28	2	43	UK207D1;H2307X	C207D1	1.0
	UKC207D1;HS2307	3.5433	1 7/64	0.079	1.693	UK207D1;HS2307	C207D1	2.2
35 1 1/4 1 3/8	UKC208D1;H2308X	100	30	2.5	46	UK208D1;H2308X	C208D1	1.3
	UKC208D1;HE2308X UKC208D1;HS2308X	3.9370	1 3/16	0.098	1.811	UK208D1;HE2308X UK208D1;HS2308X	C208D1 C208D1	2.9
40 1 7/16 1 1/2 1 5/8	UKC209D1;H2309X	110	31	2.5	50	UK209D1;H2309X	C209D1	1.6
	UKC209D1;HA2309 UKC209D1;HE2309X UKC209D1;HS2309X	4.3307	1 7/32	0.098	1.969	UK209D1;HA2309 UK209D1;HE2309X UK209D1;HS2309X	C209D1 C209D1 C209D1	3.5
45 1 5/8 1 11/16 1 3/4	UKC210D1;H2310X	120	33	2.5	55	UK210D1;H2310X	C210D1	2.1
	UKC210D1;HS2310 UKC210D1;HA2310 UKC210D1;HE2310X	4.7244	1 9/64	0.098	2.165	UK210D1;HS2310 UK210D1;HA2310 UK210D1;HE2310X	C210D1 C210D1 C210D1	4.6
50 1 7/8 1 9/16 2	UKC211D1;H2311X	125	35	2.5	59	UK211D1;H2311X	C211D1	2.3
	UKC211D1;HS2311 UKC211D1;HA2311 UKC211D1;HE2311XY	4.9213	1 3/8	0.098	2.323	UK211D1;HS2311 UK211D1;HA2311 UK211D1;HE2311XY	C211D1 C211D1 C211D1	5.1
55 2 1/8	UKC212D1;H2312X	130	38	2.5	62	UK212D1;H2312X	C212D1	2.6
	UKC212D1;HS2312	5.1181	1 1/2	0.098	2.441	UK212D1;HS2312	C212D1	5.7
60 2 3/16 2 1/4 2 3/8	UKC213D1;H2313X	140	40	3	65	UK213D1;H2313X	C213D1	3.2
	UKC213D1;HA2313 UKC213D1;HE2313X UKC213D1;HS2313X	5.5118	1 97/64	0.118	2.559	UK213D1;HA2313 UK213D1;HE2313X UK213D1;HS2313X	C213D1 C213D1 C213D1	7.1

Notes ⁽¹⁾ These numbers indicate relubricatable type. If maintenance free type is needed, please order without suffix "D1".

⁽²⁾ Adapter number with suffix "X" means a narrow slot type adapter sleeve.

In this case the lock washer with the straight inner prong should be used.

⁽³⁾ For HE2311XY, screw thread pitch different from the standard is applied, because of the thin thread section of sleeve.

To distinguish it, a suffix "Y" is added.

Remarks Please refer to page A21 for size of grease fitting.

Cartridge unit, cast housing Adapter type

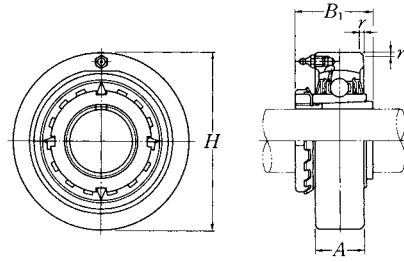

Shaft dia. mm inch	Unit number ⁽¹⁾ / ₍₂₎ / ₍₃₎	Nominal dimensions				Bearing number	Housing number	Mass of unit	
		H	A	r	B ₁			kg	lb
20 3/4	UKC305D1;H2305X	90	26	2.5	35	UK305D1;H2305X	C305D1	1.0	
	UKC305D1;HE2305	3.5433	1 1/32	0.098	1.378	UK305D1;HE2305	C305D1	2.2	
25 7/8 1	UKC306D1;H2306X	100	28	2.5	38	UK306D1;H2306X	C306D1	1.3	
	UKC306D1;HS2306 UKC306D1;HE2306X	3.9370	1 1/64	0.098	1.496	UK306D1;HS2306 UK306D1;HE2306X	C306D1 C306D1	2.9	
30 1 1/8	UKC307D1;H2307X	110	32	3	43	UK307D1;H2307X	C307D1	1.8	
	UKC307D1;HS2307	4.3307	1 1/64	0.118	1.693	UK307D1;HS2307	C307D1	4.0	
35 1 1/4 1 3/8	UKC308D1;H2308X	120	34	3	46	UK308D1;H2308X	C308D1	2.2	
	UKC308D1;HE2308X UKC308D1;HS2308X	4.7244	1 1/32	0.118	1.811	UK308D1;HE2308X UK308D1;HS2308X	C308D1 C308D1	4.9	
40 1 7/16 1 1/2 1 5/8	UKC309D1;H2309X	130	38	3.5	50	UK309D1;H2309X	C309D1	2.7	
	UKC309D1;HA2309 UKC309D1;HE2309X UKC309D1;HS2309X	5.1181	1 1/2	0.138	1.969	UK309D1;HA2309 UK309D1;HE2309X UK309D1;HS2309X	C309D1 C309D1 C309D1	6.0	
45 1 5/8 1 11/16 1 3/4	UKC310D1;H2310X	140	40	3.5	55	UK310D1;H2310X	C310D1	3.4	
	UKC310D1;HS2310 UKC310D1;HA2310 UKC310D1;HE2310X	5.5118	1 37/64	0.138	2.165	UK310D1;HS2310 UK310D1;HA2310 UK310D1;HE2310X	C310D1 C310D1 C310D1	7.5	
50 1 7/8 1 15/16 2	UKC311D1;H2311X	150	44	3.5	59	UK311D1;H2311X	C311D1	4.0	
	UKC311D1;HS2311 UKC311D1;HA2311 UKC311D1;HE2311XY	5.9055	1 47/64	0.138	2.323	UK311D1;HS2311 UK311D1;HA2311 UK311D1;HE2311XY	C311D1 C311D1 C311D1	8.8	
55 2 1/8	UKC312D1;H2312X	160	46	3.5	62	UK312D1;H2312X	C312D1	4.8	
	UKC312D1;HS2312	6.2992	1 13/16	0.138	2.441	UK312D1;HS2312	C312D1	11	
60 2 3/16 2 1/4 2 3/8	UKC313D1;H2313X	170	50	3.5	65	UK313D1;H2313X	C313D1	5.6	
	UKC313D1;HA2313 UKC313D1;HE2313X UKC313D1;HS2313X	6.6929	1 31/32	0.138	2.559	UK313D1;HA2313 UK313D1;HE2313X UK313D1;HS2313X	C313D1 C313D1 C313D1	12	

Notes ⁽¹⁾ These numbers indicate relubricatable type. If maintenance free type is needed, please order without suffix "D1".

⁽²⁾ Adapter number with suffix "X" means a narrow slot type adapter sleeve.

In this case the lock washer with the straight inner prong should be used.

⁽³⁾ For HE2311XY, screw thread pitch different from the standard is applied, because of the thin thread section of sleeve. To distinguish it, a suffix "Y" is added.

Remarks Please refer to page A21 for size of grease fitting.

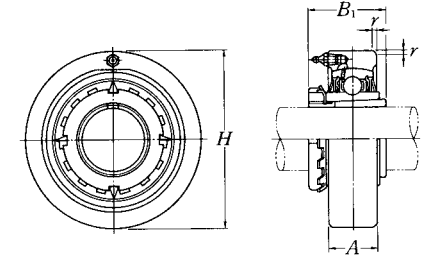

Shaft dia. mm inch	Unit number ⁽¹⁾ / ₍₂₎ / ₍₃₎	Nominal dimensions				Bearing number	Housing number	Mass of unit	
		H	A	r	B ₁			kg	lb
65 2 7/16 2 1/2	UKC315D1;H2315X	190	55	4	73	UK315D1;H2315X	C315D1	7.9	
	UKC315D1;HA2315 UKC315D1;HE2315X	7.4803	2 1/64	0.157	2.874	UK315D1;HA2315 UK315D1;HE2315X	C315D1 C315D1	17	
70 2 11/16 2 3/4	UKC316D1;H2316X	200	60	4	78	UK316D1;H2316X	C316D1	9.4	
	UKC316D1;HA2316 UKC316D1;HE2316X	7.8740	2 23/64	0.157	3.071	UK316D1;HA2316 UK316D1;HE2316X	C316D1 C316D1	21	
75 2 5/8 3	UKC317D1;H2317X	215	64	4	82	UK317D1;H2317X	C317D1	11	
	UKC317D1;HA2317X UKC317D1;HE2317X	8.4646	2 33/64	0.157	3.228	UK317D1;HA2317X UK317D1;HE2317X	C317D1 C317D1	24	
80 3 3/16	UKC318D1;H2318X	225	66	4	86	UK318D1;H2318X	C318D1	13	
	UKC318D1;HA2318X	8.8583	2 19/32	0.157	3.386	UK318D1;HA2318X	C318D1	29	
85 3 1/4	UKC319D1;H2319X	240	72	4	90	UK319D1;H2319X	C319D1	16	
	UKC319D1;HE2319X	9.4488	2 53/64	0.157	3.543	UK319D1;HE2319X	C319D1	35	
90 3 7/16 3 1/2	UKC320D1;H2320X	260	75	4	97	UK320D1;H2320X	C320D1	20	
	UKC320D1;HA2320 UKC320D1;HE2320X	10.2362	2 61/64	0.157	3.819	UK320D1;HA2320 UK320D1;HE2320X	C320D1 C320D1	44	
100	UKC322D1;H2322X	300	80	5	105	UK322D1;H2322X	C322D1	29	
110	UKC324D1;H2324	320	90	5	112	UK324D1;H2324	C324D1	35	
115	UKC326D1;H2326	340	100	5	121	UK326D1;H2326	C326D1	43	
125	UKC328D1;H2328	360	100	5	131	UK328D1;H2328	C328D1	50	

Notes ⁽¹⁾ These numbers indicate relubricatable type. If maintenance free type is needed, please order without suffix "D1".

⁽²⁾ Adapter number with suffix "X" means a narrow slot type adapter sleeve.

In this case the lock washer with the straight inner prong should be used.

Remarks Please refer to page A21 for size of grease fitting.

Cartridge unit, cast housing Adapter type

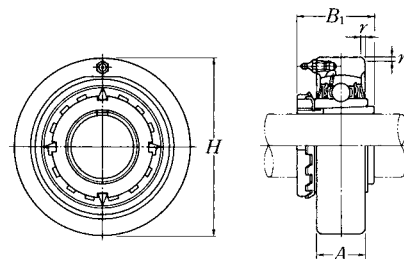

Shaft dia. mm inch	Unit number ⁽¹⁾ (²)(³)	Nominal dimensions				Bearing number	Housing number	Mass of unit kg lb
		mm inch						
		H	A	r	B ₁			
20 3/4	UKCX05D1;H2305X	90	27	2	35	UKX05D1;H2305X	CX05D1	1.1
	UKCX05D1;HE2305	3.5433	1 1/16	0.079	1.378	UKX05D1;HE2305	CX05D1	2.4
25 7/8 1	UKCX06D1;H2306X	100	30	2.5	38	UKX06D1;H2306X	CX06D1	1.4
	UKCX06D1;HS2306	3.9370	1 3/16	0.098	1.496	UKX06D1;HS2306	CX06D1	3.1
	UKCX06D1;HE2306X					CX06D1		
30 1 1/8	UKCX07D1;H2307X	110	34	2.5	43	UKX07D1;H2307X	CX07D1	1.8
	UKCX07D1;HS2307	4.3307	1 1/2	0.098	1.693	UKX07D1;HS2307	CX07D1	4.0
35 1 1/4 1 3/8	UKCX08D1;H2308X	120	38	2.5	46	UKX08D1;H2308X	CX08D1	2.5
	UKCX08D1;HE2308X	4.7244	1 1/2	0.098	1.811	UKX08D1;HE2308X	CX08D1	5.5
	UKCX08D1;HS2308X					CX08D1		
40 1 7/16 1 1/2 1 5/8	UKCX09D1;H2309X	120	38	2.5	50	UKX09D1;H2309X	CX09D1	2.2
	UKCX09D1;HA2309	4.7244	1 1/2	0.098	1.969	UKX09D1;HA2309	CX09D1	4.9
	UKCX09D1;HE2309X					CX09D1		
	UKCX09D1;HS2309X					CX09D1		
45 1 5/8 1 11/16 1 3/4	UKCX10D1;H2310X	130	40	2.5	55	UKX10D1;H2310X	CX10D1	2.7
	UKCX10D1;HS2310	5.1181	1 37/64	0.098	2.165	UKX10D1;HS2310	CX10D1	6.0
	UKCX10D1;HA2310					CX10D1		
	UKCX10D1;HE2310X					CX10D1		
50 1 7/8 1 9/16 2	UKCX11D1;H2311X	150	42	3	59	UKX11D1;H2311X	CX11D1	4.0
	UKCX11D1;HS2311	5.9055	1 21/32	0.118	2.323	UKX11D1;HS2311	CX11D1	8.8
	UKCX11D1;HA2311					CX11D1		
	UKCX11D1;HE2311XY					CX11D1		
55 2 1/8	UKCX12D1;H2312X	160	44	3	62	UKX12D1;H2312X	CX12D1	3.9
	UKCX12D1;HS2312	6.2992	1 37/64	0.118	2.441	UKX12D1;HS2312	CX12D1	8.6

Notes ⁽¹⁾ These numbers indicate relubricatable type. If maintenance free type is needed, please order without suffix "D1".

⁽²⁾ Adapter number with suffix "X" means a narrow slot type adapter sleeve.
In this case the lock washer with the straight inner prong should be used.

⁽³⁾ For HE2311XY, screw thread pitch different from the standard is applied, because of the thin thread section of sleeve.
To distinguish it, a suffix "Y" is added.

Remarks Please refer to page A21 for size of grease fitting.

Ball bearings Set screw type

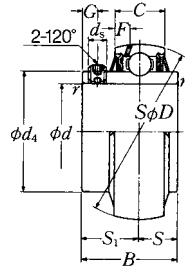

Shaft dia. mm inch	Bearing (¹) number	Nominal dimensions										
		<i>d</i>	<i>D</i>	<i>B</i>	<i>C</i>	<i>r</i> min.	<i>S</i>	<i>S</i> ₁	<i>G</i>	<i>d</i> _s	<i>d</i> ₄	<i>F</i>
12 ½	UC201D1	12	47	31	17	0.6	12.7	18.3	4.5	M5×0.8	29.6	4.7
	UC201-008D1	0.5000	1.8504	1.2205	0.6693	0.024	0.500	0.720	0.177	No.10-32UNF	1.1654	0.185
15 9/16 5/8	UC202D1	15	47	31	17	0.6	12.7	18.3	4.5	M5×0.8	29.6	4.7
	UC202-009D1 UC202-010D1	0.5625 0.6250	1.8504	1.2205	0.6693	0.024	0.500	0.720	0.177	No.10-32UNF	1.1654	0.185
17 11/16	UC203D1	17	47	31	17	0.6	12.7	18.3	4.5	M5×0.8	29.6	4.7
	UC203-011D1	0.6875	1.8504	1.2205	0.6693	0.024	0.500	0.720	0.177	No.10-32UNF	1.1654	0.185
20 ¾	UC204D1	20	47	31	17	1	12.7	18.3	4.5	M5×0.8	29.6	4.7
	UC204-012D1	0.7500	1.8504	1.2205	0.6693	0.039	0.500	0.720	0.177	No.10-32UNF	1.1654	0.185
25 13/16 7/8 15/16	UC205D1	25	52	34.1	17	1	14.3	19.8	5	M5×0.8	33.9	4.5
	UC205-013D1	0.8125										
	UC205-014D1	0.8750	2.0472	1.3425	0.6693	0.039	0.563	0.780	0.197	No.10-32UNF	1.3346	0.177
	UC205-015D1 UC205-100D1	0.9375 1.0000										
30 1 1/16 1 1/8 1 3/16 1 1/4	UC206D1	30	62	38.1	19	1	15.9	22.2	5	M6×0.75	40.8	4.6
	UC206-101D1	1.0625										
	UC206-102D1	1.1250	2.4409	1.5000	0.7480	0.039	0.626	0.874	0.197	¼-28UNF	1.6063	0.181
	UC206-103D1 UC206-104D1	1.1875 1.2500										
35 1 1/4 1 5/16 1 3/8 1 7/16	UC207D1	35	72	42.9	20	1.5	17.5	25.4	6	M6×0.75	46.8	4.6
	UC207-104D1	1.2500										
	UC207-105D1	1.3125	2.8346	1.6890	0.7874	0.059	0.689	1.000	0.236	¼-28UNF	1.8425	0.181
	UC207-106D1 UC207-107D1	1.3750 1.4375										
40 1 1/2 1 5/16	UC208D1	40	80	49.2	21	1.5	19	30.2	8	M8×1	53	4.5
	UC208-108D1	1.5000	3.1496	1.9370	0.8268	0.059	0.748	1.189	0.315	5/16-24UNF	2.0866	0.177
	UC208-109D1	1.5625										
45 1 5/8 1 11/16 1 3/4	UC209D1	45	85	49.2	22	1.5	19	30.2	8	M8×1	57.5	4.9
	UC209-110D1	1.6250	3.3465	1.9370	0.8661	0.059	0.748	1.189	0.315	5/16-24UNF	2.2638	0.193
	UC209-111D1 UC209-112D1	1.6875 1.7500										

Note (¹) These numbers indicate relubricatable type. If maintenance free type is needed, please order without suffix "D1".

Basic load ratings		Mass kg lb
N lbf	N lbf	
dynamic <i>C</i> _r	static <i>C</i> _{0r}	
12 800 2 890	6 650 1 500	0.21 0.46
12 800 2 890	6 650 1 500	0.20 0.44 0.42
12 800 2 890	6 650 1 500	0.18 0.39
12 800 2 890	6 650 1 500	0.17 0.39
14 000 3 150	7 850 1 770	0.20 0.53 0.51 0.46 0.44
19 500 4 400	11 300 2 540	0.32 0.82 0.77 0.73 0.66
25 700 5 750	15 300 3 450	0.46 1.21 1.15 1.08 1.01
29 100 6 550	17 800 4 000	0.64 1.52 1.46
32 500 7 350	20 400 4 600	0.68 1.76 1.68 1.57

Ball bearings Set screw type

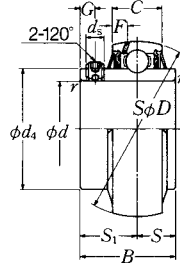

Shaft dia. mm inch	Bearing (1) number	Nominal dimensions										
		<i>d</i>	<i>D</i>	<i>B</i>	<i>C</i>	<i>r</i> min.	mm inch		<i>G</i>	<i>d_s</i>	<i>d₄</i>	<i>F</i>
50	UC210D1	50	90	51.6	24	1.5	19	32.6	9	M8×1	62.4	5.9
1 ³ / ₁₆	UC210-113D1	1.8125										
1 ⁷ / ₈	UC210-114D1	1.8750	3.5433	2.0315	0.9449	0.059	0.748	1.283	0.354	5/16-24UNF	2.4567	0.232
1 ¹⁵ / ₁₆	UC210-115D1	1.9375										
2	UC210-200D1	2.0000										
55	UC211D1	55	100	55.6	25	2	22.2	33.4	9	M8×1	69	6.0
2	UC211-200D1	2.0000										
2 ¹ / ₁₆	UC211-201D1	2.0625	3.9370	2.1890	0.9843	0.079	0.874	1.315	0.354	5/16-24UNF	2.7165	0.236
2 ¹ / ₈	UC211-202D1	2.1250										
2 ³ / ₁₆	UC211-203D1	2.1875										
60	UC212D1	60	110	65.1	27	2	25.4	39.7	10	M10×1.25	77	6.2
2 ¹ / ₄	UC212-204D1	2.2500										
2 ⁵ / ₁₆	UC212-205D1	2.3125	4.3307	2.5630	1.0630	0.079	1.000	1.563	0.394	3/8-24UNF	3.0315	0.244
2 ³ / ₈	UC212-206D1	2.3750										
2 ⁷ / ₁₆	UC212-207D1	2.4375										
65	UC213D1	65	120	65.1	32	2	25.4	39.7	10	M10×1.25	82.5	8.7
2 ¹ / ₂	UC213-208D1	2.5000	4.7244	2.5630	1.2598	0.079	1.000	1.563	0.394	3/8-24UNF	3.2480	0.343
2 ⁹ / ₁₆	UC213-209D1	2.5625										
70	UC214D1	70	125	74.6	33	2	30.2	44.4	12	M10×1.25	87	8.8
2 ⁵ / ₈	UC214-210D1	2.6250										
2 ¹¹ / ₁₆	UC214-211D1	2.6875	4.9213	2.9370	1.2992	0.079	1.189	1.748	0.472	3/8-24UNF	3.4252	0.346
2 ³ / ₄	UC214-212D1	2.7500										
75	UC215D1	75	130	77.8	34	2	33.3	44.5	12	M10×1.25	93	9.0
2 ¹³ / ₁₆	UC215-213D1	2.8125										
2 ⁷ / ₈	UC215-214D1	2.8750	5.1181	3.0630	1.3386	0.079	1.311	1.752	0.472	3/8-24UNF	3.6614	0.354
2 ⁹ / ₁₆	UC215-215D1	2.9375										
3	UC215-300D1	3.0000										
80	UC216D1	80	140	82.6	35	2.5	33.3	49.3	12	M10×1.25	98.1	9.5
3 ¹ / ₁₆	UC216-301D1	3.0625										
3 ³ / ₈	UC216-302D1	3.1250	5.5118	3.2520	1.3780	0.098	1.311	1.941	0.472	3/8-24UNF	3.8622	0.374
3 ³ / ₁₆	UC216-303D1	3.1875										

Note (1) These numbers indicate relubricatable type. If maintenance free type is needed, please order without suffix "D1".

Basic load ratings		Mass
N lbf		kg lb
dynamic <i>C_r</i>	static <i>C_{0r}</i>	
35 000	23 200	0.78 2.03
7 900	5 200	1.92 1.81 1.69
43 500	29 200	1.04 2.71
9 750	6 550	2.60 2.46 2.34
52 500	36 000	1.46 3.66
11 800	8 150	3.50 3.33 3.17
57 500	40 000	1.86 4.26
12 900	9 000	4.09
62 000	44 000	2.10 5.09
14 000	9 900	4.87 4.65
66 000	49 500	2.34 5.73
14 900	11 100	5.49 5.25 4.98
72 500	53 000	2.78 6.57
16 300	11 900	6.28 6.00

UC2

Ball bearings Set screw type

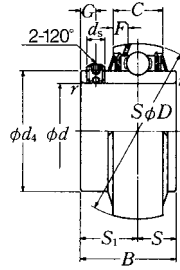

Shaft dia. mm inch	Bearing (1) number	Nominal dimensions										
		<i>d</i>	<i>D</i>	<i>B</i>	<i>C</i>	<i>r</i> min.	mm inch		<i>G</i>	<i>d_s</i>	<i>d₄</i>	<i>F</i>
85	UC217D1	85	150	85.7	36	2.5	34.1	51.6	12	M12×1.5	106.4	10.1
3 1/4	UC217-304D1	3.2500										
3 5/16	UC217-305D1	3.3125	5.9055	3.3740	1.4173	0.098	1.343	2.031	0.472	1/2-20UNF	4.1890	0.398
3 7/16	UC217-307D1	3.4375										
90	UC218D1	90	160	96	37	2.5	39.7	56.3	12	M12×1.5	111.6	9.8
3 1/2	UC218-308D1	3.5000	6.2992	3.7795	1.4567	0.098	1.563	2.217	0.472	1/2-20UNF	4.3937	0.386

Note (1) These numbers indicate relubricatable type. If maintenance free type is needed, please order without suffix "D1".

Basic load ratings		Mass
N lbf		kg lb
dynamic <i>C_r</i>	static <i>C_{0r}</i>	
83 500	64 000	3.54 7.92
18 700	14 300	7.60 6.97
96 000	71 500	4.40
21 600	16 100	9.88

Ball bearings Set screw type

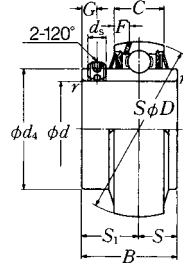

Shaft dia. mm inch	Bearing (1) number	Nominal dimensions										
		<i>d</i>	<i>D</i>	<i>B</i>	<i>C</i>	<i>r</i> min.	mm inch		<i>G</i>	<i>d_s</i>	<i>d₄</i>	<i>F</i>
25 1 3/16	UC305D1	25	62	38	20	1.5	15	23	6	M6×0.75	36.8	5.0
	UC305-013D1	0.8125										
	UC305-014D1	0.8750	2.4409	1.4961	0.7874	0.059	0.591	0.906	0.236	1/4-28UNF	1.4488	0.197
	UC305-015D1	0.9375										
1	UC305-100D1	1.0000										
30 1 1/16	UC306D1	30	72	43	23	1.5	17	26	6	M6×0.75	44.9	5.9
	UC306-101D1	1.0625										
	UC306-102D1	1.1250	2.8346	1.6929	0.9055	0.059	0.669	1.024	0.236	1/4-28UNF	1.7677	0.232
	UC306-103D1	1.1875										
35 1 1/4	UC307D1	35	80	48	25	2	19	29	8	M8×1	49.4	6.8
	UC307-104D1	1.2500										
	UC307-105D1	1.3125	3.1496	1.8898	0.9843	0.079	0.748	1.142	0.315	5/16-24UNF	1.9449	0.268
	UC307-106D1	1.3750										
	UC307-107D1	1.4375										
40 1 1/2	UC308D1	40	90	52	27	2	19	33	10	M10×1.25	56	7.4
	UC308-108D1	1.5000	3.5433	2.0472	1.0630	0.079	0.748	1.299	0.394	3/8-24UNF	2.2047	0.291
	UC308-109D1	1.5625										
45 1 5/8	UC309D1	45	100	57	29	2	22	35	10	M10×1.25	63.5	7.4
	UC309-110D1	1.6250										
	UC309-111D1	1.6875	3.9370	2.2441	1.1417	0.079	0.866	1.378	0.394	3/8-24UNF	2.5000	0.291
	UC309-112D1	1.7500										
50 1 3/4	UC310D1	50	110	61	32	2.5	22	39	12	M12×1.5	70.6	8.1
	UC310-113D1	1.8125										
	UC310-114D1	1.8750	4.3307	2.4016	1.2598	0.098	0.866	1.535	0.472	1/2-20UNF	2.7795	0.319
	UC310-115D1	1.9375										

Note (1) These numbers indicate relubricatable type. If maintenance free type is needed, please order without suffix "D1".

Basic load ratings		Mass
N lbf		kg lb
dynamic <i>C_r</i>	static <i>C_{0r}</i>	
21 200	10 900	0.35 0.88
4 750	2 460	0.84 0.79
		0.77
26 700	15 000	0.56 1.34
6 000	3 400	1.28 1.23
33 500	19 100	0.70 1.70
7 500	4 300	1.63 1.57
		1.50
40 500	24 000	0.96 2.23
9 150	5 400	2.14 2.14
53 000	32 000	1.28 3.06
11 900	7 200	2.98 2.87
62 000	38 500	1.68 3.95
13 900	8 600	3.84 3.70

Ball bearings Set screw type

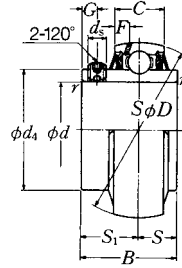

Shaft dia. mm inch	Bearing (1) number	Nominal dimensions										
		<i>d</i>	<i>D</i>	<i>B</i>	<i>C</i>	<i>r</i> min.	mm		<i>G</i>	<i>d_s</i>	<i>d₄</i>	<i>F</i>
							<i>S</i>	<i>S₁</i>				
55	UC311D1	55	120	66	34	2.5	25	41	12	M12×1.5	76.6	8.5
2	UC311-200D1	2.0000										
2 1/16	UC311-201D1	2.0625	4.7244	2.5984	1.3386	0.098	0.984	1.614	0.472	1/2-20UNF	3.0157	0.335
2 3/8	UC311-202D1	2.1250										
2 1/2	UC311-203D1	2.1875										
60	UC312D1	60	130	71	36	2.5	26	45	12	M12×1.5	82.7	9.0
2 1/4	UC312-204D1	2.2500										
2 5/16	UC312-205D1	2.3125	5.1181	2.7953	1.4173	0.098	1.024	1.772	0.472	1/2-20UNF	3.2559	0.354
2 3/8	UC312-206D1	2.3750										
2 7/16	UC312-207D1	2.4375										
65	UC313D1	65	140	75	39	2.5	30	45	12	M12×1.5	88.2	10.1
2 1/2	UC313-208D1	2.5000	5.5118	2.9528	1.5354	0.098	1.181	1.772	0.472	1/2-20UNF	3.4724	0.398
2 9/16	UC313-209D1	2.5625										
70	UC314D1	70	150	78	41	2.5	33	45	12	M12×1.5	94.8	10.5
2 5/8	UC314-210D1	2.6250										
2 11/16	UC314-211D1	2.6875	5.9055	3.0709	1.6142	0.098	1.299	1.772	0.472	1/2-20UNF	3.7323	0.413
2 3/4	UC314-212D1	2.7500										
75	UC315D1	75	160	82	43	2.5	32	50	14	M14×1.5	101.3	11.0
2 3/8	UC315-213D1	2.8125										
2 7/8	UC315-214D1	2.8750	6.2992	3.2283	1.6929	0.098	1.260	1.969	0.551	9/16-18UNF	3.9882	0.433
2 9/16	UC315-215D1	2.9375										
3	UC315-300D1	3.0000										
80	UC316D1	80	170	86	45	2.5	34	52	14	M14×1.5	107.9	11.4
3 1/16	UC316-301D1	3.0625										
3 1/8	UC316-302D1	3.1250	6.6929	3.3858	1.7717	0.098	1.339	2.047	0.551	9/16-18UNF	4.2480	0.449
3 3/16	UC316-303D1	3.1875										

Note (1) These numbers indicate relubricatable type. If maintenance free type is needed, please order without suffix "D1".

Basic load ratings		Mass kg lb
N	lbf	
dynamic <i>C_r</i>	static <i>C_{0r}</i>	
71 500	45 000	2.08 4.96
16 100	10 100	4.81 4.67 4.50
82 000	52 000	2.60 6.06 5.89
18 400	11 700	5.68 5.51
92 500	60 000	3.25 7.36 7.14
20 800	13 400	
104 000	68 000	3.86 9.06 8.82 8.60
23 400	15 300	
113 000	77 000	4.70 11.0 10.7 10.5 10.2
25 500	17 400	
123 000	86 500	5.60 12.6 12.3 12.1
27 600	19 500	

Ball bearings Set screw type

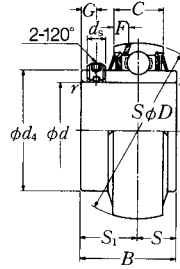

Shaft dia. mm inch	Bearing (1) number	Nominal dimensions										
		<i>d</i>	<i>D</i>	<i>B</i>	<i>C</i>	<i>r</i> min.	mm inch		<i>G</i>	<i>d_s</i>	<i>d₄</i>	<i>F</i>
							<i>S</i>	<i>S₁</i>				
85 3 1/4 3 5/16 3 7/16	UC317D1 UC317-304D1 UC317-305D1 UC317-307D1	85 3.2500 3.3125 3.4375	180 7.0866	96 3.7795	47 1.8504	3 0.118	40 1.575	56 2.205	16 0.630	M16×1.5 5/8-18UNF	114.4 4.5039	12.0 0.472
90 3 7/16 3 1/2	UC318D1 UC318-307D1 UC318-308D1	90 3.4375 3.5000	190 7.4803	96 3.7795	49 1.9291	3 0.118	40 1.575	56 2.205	16 0.630	M16×1.5 5/8-18UNF	120.9 4.7598	12.3 0.484
95 3 5/8 3 11/16 3 3/4	UC319D1 UC319-310D1 UC319-311D1 UC319-312D1	95 3.6250 3.6875 3.7500	200 7.8740	103 4.0551	51 2.0079	3 0.118	41 1.614	62 2.441	16 0.630	M16×1.5 5/8-18UNF	127.5 5.0197	12.8 0.504
100 3 13/16 3 7/8 3 15/16 4	UC320D1 UC320-313D1 UC320-314D1 UC320-315D1 UC320-400D1	100 3.8125 3.8750 3.9375 4.0000	215 8.4646	108 4.2520	55 2.1654	3 0.118	42 1.654	66 2.598	18 0.709	M18×1.5 5/8-18UNF	135.6 5.3386	13.5 0.531
105	UC321D1	105	225	112	57	3	44	68	18	M18×1.5	142.1	13.9
110	UC322D1	110	240	117	59	3	46	71	18	M18×1.5	151.7	13.9
120	UC324D1	120	260	126	63	3	51	75	18	M18×1.5	165.2	16.0
130	UC326D1	130	280	135	67	4	54	81	20	M20×1.5	178.3	16.9
140	UC328D1	140	300	145	71	4	59	86	20	M20×1.5	190.4	17.7

Note (1) These numbers indicate relubricatable type. If maintenance free type is needed, please order without suffix "D1".

Basic load ratings		Mass kg lb
N lbf		
dynamic <i>C_r</i>	static <i>C_{0r}</i>	
133 000	97 000	6.70 15.2
29 800	21 800	14.9 14.2
143 000	107 000	7.60 17.3
32 000	24 100	16.9
153 000	119 000	8.70 19.9
34 500	26 600	19.5 19.1
173 000	141 000	10.8 24.7
39 000	31 500	24.2 23.8 23.4
184 000	153 000	12.2
205 000	179 000	14.3
207 000	185 000	18.5
229 000	214 000	23.0
253 000	246 000	28.5

Ball bearings Set screw type

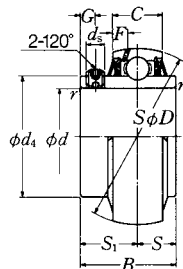

Shaft dia. mm inch	Bearing (¹) number	Nominal dimensions										
		<i>d</i>	<i>D</i>	<i>B</i>	<i>C</i>	<i>r</i> min.	mm inch		<i>G</i>	<i>d_s</i>	<i>d₄</i>	<i>F</i>
25 1 3/16 7/8 15/16 1	UCX05D1	25	62	38.1	19	1	15.9	22.2	5	M6×0.75	40.8	4.6
	UCX05-013D1	0.8125										
	UCX05-014D1	0.8750	2.4409	1.5000	0.7480	0.039	0.626	0.874	0.197	¼-28UNF	1.6063	0.181
	UCX05-015D1	0.9375										
30 1 1/16 1 1/8 1 3/16	UCX06D1	30	72	42.9	20	1	17.5	25.4	6	M8×1	46.8	4.6
	UCX06-101D1	1.0625										
	UCX06-102D1	1.1250	2.8346	1.6890	0.7874	0.039	0.689	1.000	0.236	5/16-24UNF	1.8425	0.181
	UCX06-103D1	1.1875										
35 1 5/16 1 3/8 1 7/16	UCX07D1	35	80	49.2	21	1.5	19	30.2	8	M8×1	53	4.5
	UCX07-105D1	1.3125										
	UCX07-106D1	1.3750	3.1496	1.9370	0.8268	0.059	0.748	1.189	0.315	5/16-24UNF	2.0866	0.177
	UCX07-107D1	1.4375										
40 1 1/2 1 5/16	UCX08D1	40	85	49.2	22	1.5	19	30.2	8	M8×1	57.5	4.9
	UCX08-108D1	1.5000										
	UCX08-109D1	1.5625	3.3465	1.9370	0.8661	0.059	0.748	1.189	0.315	5/16-24UNF	2.2638	0.193
45 1 5/8 1 11/16 1 3/4	UCX09D1	45	90	51.6	24	1.5	19	32.6	9	M10×1.25	62.4	5.9
	UCX09-110D1	1.6250										
	UCX09-111D1	1.6875	3.5433	2.0315	0.9449	0.059	0.748	1.283	0.354	3/8-24UNF	2.4567	0.232
	UCX09-112D1	1.7500										
50 1 7/8 1 15/16	UCX10D1	50	100	55.6	25	1.5	22.2	33.4	9	M10×1.25	69	6.0
	UCX10-114D1	1.8750										
	UCX10-115D1	1.9375	3.9370	2.1890	0.9843	0.059	0.874	1.315	0.354	3/8-24UNF	2.7165	0.236
55 2 1/16 2 1/8 2 3/16	UCX11D1	55	110	65.1	27	2	25.4	39.7	10	M10×1.25	77	6.2
	UCX11-201D1	2.0625										
	UCX11-202D1	2.1250	4.3307	2.5630	1.0630	0.079	1.000	1.563	0.394	3/8-24UNF	3.0315	0.244
	UCX11-203D1	2.1875										
60 2 3/8 2 7/16	UCX12D1	60	120	65.1	32	2	25.4	39.7	10	M10×1.25	82.5	8.7
	UCX12-206D1	2.3750										
	UCX12-207D1	2.4375	4.7244	2.5630	1.2598	0.079	1.000	1.563	0.394	3/8-24UNF	3.2480	0.343

Note (¹) These numbers indicate relubricatable type. If maintenance free type is needed, please order without suffix "D1".

Basic load ratings	N lbf		Mass kg lb
	dynamic <i>C_r</i>	static <i>C_{0r}</i>	
	19 500	11 300	0.39 0.97
	4 400	2 540	0.93 0.88 0.84
	25 700	15 300	0.68 1.61
	5 750	3 450	1.54 1.50
	29 100	17 800	0.74 1.87
	6 550	4 000	1.81 1.74
	32 500	20 400	0.80 2.16 2.07
	7 350	4 600	
	35 000	23 200	0.94 2.43
	7 900	5 200	2.34 2.25
	43 500	29 200	1.22 3.15 3.04
	9 750	6 550	
	52 500	36 000	1.72 4.43 4.30 4.12
	11 800	8 150	
	57 500	40 000	2.10 4.96 4.81
	12 900	9 000	

Ball bearings Set screw type

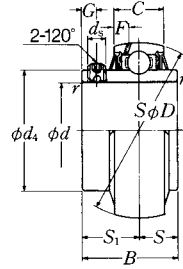

Shaft dia. mm inch	Bearing (1) number	Nominal dimensions										
		<i>d</i>	<i>D</i>	<i>B</i>	<i>C</i>	<i>r</i> min.	mm		<i>G</i>	<i>d_s</i>	<i>d₄</i>	<i>F</i>
							<i>S</i>	<i>S₁</i>				
65 2 1/2 2 9/16	UCX13D1 UCX13-208D1 UCX13-209D1	65 2.5000 2.5625	125 4.9213	74.6 2.9370	33 1.2992	2 0.079	30.2 1.189	44.4 1.748	12 0.472	M12×1.5 1/2-20UNF	87 3.4252	8.8 0.346
70 2 5/8 2 11/16 2 3/4	UCX14D1 UCX14-210D1 UCX14-211D1 UCX14-212D1	70 2.6250 2.6875 2.7500	130 5.1181	77.8 3.0630	34 1.3386	2 0.079	33.3 1.311	44.5 1.752	12 0.472	M12×1.5 1/2-20UNF	93 3.6614	9.0 0.354
75 2 13/16 2 7/8 2 15/16 3	UCX15D1 UCX15-213D1 UCX15-214D1 UCX15-215D1 UCX15-300D1	75 2.8125 2.8750 2.9375 3.0000	140 5.5118	82.6 3.2520	35 1.3780	2 0.079	33.3 1.311	49.3 1.941	12 0.472	M12×1.5 1/2-20UNF	98.1 3.8622	9.5 0.374
80 3 1/16 3 1/8 3 3/16	UCX16D1 UCX16-301D1 UCX16-302D1 UCX16-303D1	80 3.0625 3.1250 3.1875	150 5.9055	85.7 3.3740	36 1.4173	2.5 0.098	34.1 1.343	51.6 2.031	12 0.472	M12×1.5 1/2-20UNF	106.4 4.1890	10.1 0.398
85 3 5/16 3 7/16	UCX17D1 UCX17-305D1 UCX17-307D1	85 3.3125 3.4375	160 6.2992	96 3.7795	37 1.4567	2.5 0.098	39.7 1.563	56.3 2.217	12 0.472	M12×1.5 1/2-20UNF	111.6 4.3937	9.8 0.386
90 3 7/16 3 1/2	UCX18D1 UCX18-307D1 UCX18-308D1	90 3.4375 3.5000	170 6.6929	104 4.0945	39 1.5354	2.5 0.098	42.9 1.689	61.1 2.406	14 0.551	M14×1.5 9/16-18UNF	118.2 4.6535	10.5 0.413
100 3 13/16 3 7/8 3 15/16 4	UCX20D1 UCX20-313D1 UCX20-314D1 UCX20-315D1 UCX20-400D1	100 3.8125 3.8750 3.9375 4.0000	190 7.4803	117.5 4.6260	44 1.7323	2.5 0.098	49.2 1.937	68.3 2.689	16 0.630	M16×1.5 5/8-18UNF	131.3 5.1693	11.3 0.445

Note (1) These numbers indicate relubricatable type. If maintenance free type is needed, please order without suffix "D1".

Basic load ratings		Mass
N lbf		kg lb
dynamic <i>C_r</i>	static <i>C_{0r}</i>	
62 000	44 000	2.45
14 000	9 900	5.60
		5.38
66 000	49 500	2.47
		5.93
14 900	11 100	5.69
		5.47
72 500	53 000	3.11
		7.43
16 300	11 900	7.19
		6.92
		6.66
83 500	64 000	3.96
		8.75
18 700	14 300	8.47
		8.18
96 000	71 500	4.72
		10.8
21 600	16 100	10.1
109 000	82 000	5.50
		13.3
24 500	18 400	12.4
133 000	105 000	8.06
		18.8
29 900	23 500	18.4
		19.7
		19.2

Ball bearings Set screw type

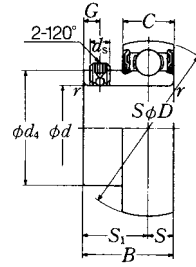

Shaft dia. mm inch	Bearing (1) number	Nominal dimensions									
		<i>d</i>	<i>D</i>	<i>B</i>	<i>C</i>	<i>r</i>	<i>S</i>	<i>S</i> ₁	<i>G</i>	<i>d</i> _s	<i>d</i> ₄
12 1/2	AS201 AS201-008	12 0.5000	40 1.5748	22 0.8661	12 0.4724	0.6 0.024	6 0.236	16 0.630	4.2 0.165	M5×0.8 No.10-32UNF	24.3 0.957
15 9/16 5/8	AS202 AS202-009 AS202-010	15 0.5625 0.6250	40 1.5748	22 0.8661	12 0.4724	0.6 0.024	6 0.236	16 0.630	4.2 0.165	M5×0.8 No.10-32UNF	24.3 0.957
17 11/16	AS203 AS203-011	17 0.6875	40 1.5748	22 0.8661	12 0.4724	0.6 0.024	6 0.236	16 0.630	4.2 0.165	M5×0.8 No.10-32UNF	24.3 0.957
20 3/4	AS204 AS204-012	20 0.7500	47 1.8504	25 0.9843	14 0.5512	1 0.039	7 0.276	18 0.709	4.2 0.165	M5×0.8 No.10-32UNF	29.6 1.165
25 13/16 7/8 15/16 1	AS205 AS205-013 AS205-014 AS205-015 AS205-100	25 0.8125 0.8750 0.9375 1.0000	52 2.0472	27 1.0630	15 0.5906	1 0.039	7.5 0.295	19.5 0.768	5 0.197	M5×0.8 No.10-32UNF	33.9 1.335
30 1 1/16 1 1/8 1 3/16 1 1/4	AS206 AS206-101 AS206-102 AS206-103 AS206-104	30 1.0625 1.1250 1.1875 1.2500	62 2.4409	29 1.1417	16 0.6299	1 0.039	8 0.315	21 0.827	5 0.197	M6×0.75 1/4-28UNF	40.8 1.606
35 1 1/4 1 5/16 1 3/8 1 7/16	AS207 AS207-104 AS207-105 AS207-106 AS207-107	35 1.2500 1.3125 1.3750 1.4375	72 2.8346	34 1.3386	17 0.6693	1.5 0.059	8.5 0.335	25.5 1.004	6 0.236	M6×0.75 1/4-28UNF	46.8 1.843
40 1 1/2 1 5/16	AS208 AS208-108 AS208-109	40 1.5000 1.5625	80 3.1496	38 1.4961	18 0.7087	1.5 0.059	9 0.354	29 1.142	8 0.315	M8×1 5/16-24UNF	53 2.087

Note (1) If relubricatable type is needed, please order with suffix "D1".

Basic load ratings		Mass kg lb
N dynamic <i>C</i> _r	lbf static <i>C</i> _{0r}	
9 600 2 160	4 600 1 030	0.10 0.22
9 600 2 160	4 600 1 030	0.09 0.21 0.20
9 600 2 160	4 600 1 030	0.08 0.18
12 800 2 890	6 650 1 500	0.13 0.29
14 000 3 150	7 850 1 770	0.16 0.42 0.40 0.38 0.35
19 500 4 400	11 300 2 540	0.25 0.61 0.59 0.57 0.55
25 700 5 750	15 300 3 450	0.38 1.06 0.93 0.81 0.69
29 100 6 550	17 800 4 000	0.51 1.15 1.06

Ball bearings Set screw type

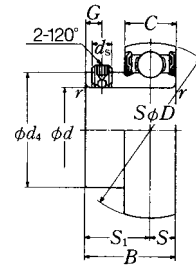

Shaft dia. mm inch	Bearing (*) number	Nominal dimensions									
		<i>d</i>	<i>D</i>	<i>B</i>	<i>C</i>	<i>r</i> min.	<i>S</i> mm inch	<i>S</i> ₁	<i>G</i>	<i>d</i> _s	<i>d</i> ₄
45 1 7/8	AS209	45	85	40	19	1.5	9.5	30.5	8	M8×1	57.5
1 13/16	AS209-110	1.6250									
1 11/16	AS209-111	1.6875	3.3465	1.5748	0.7480	0.059	0.374	1.201	0.315	5/16-24UNF	2.2638
1 3/4	AS209-112	1.7500									
50 1 13/16	AS210	50	90	42	20	1.5	10	32	9	M8×1	62.4
1 11/16	AS210-113	1.8125									
1 7/8	AS210-114	1.8750	3.5433	1.6535	0.7874	0.059	0.394	1.260	0.354	5/16-24UNF	2.4567
1 5/8	AS210-115	1.9375									
2	AS210-200	2.0000									

Note (*) If relubricatable type is needed, please order with "D1".

Basic load ratings		Mass
N lbf	kg lb	
dynamic <i>C</i> _r	static <i>C</i> _{0r}	
32 500	20 400	0.55
		1.39
7 350	4 600	1.32
		1.23
35 000	23 200	0.65
		1.65
7 900	5 200	1.57
		1.48
		1.39

Ball bearings Set screw type

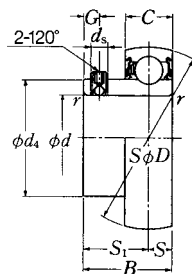

Shaft dia. mm inch	Bearing (1) number	Nominal dimensions										
		<i>d</i>	<i>D</i>	<i>B</i>	<i>C</i>	mm		inch		<i>G</i>	<i>d_s</i>	<i>d₄</i>
						<i>r</i>	<i>S</i>	<i>S₁</i>	<i>S₂</i>			
12 1/2	AR201 AR201-008	12 0.5000	40 1.5748	22.5 0.8858	13 0.5118	0.6 0.024	6.5 0.256	16 0.630	5 0.197	M6x0.75 1/4-28UNF	24.4 0.9606	
15 9/16 5/8	AR202 AR202-009 AR202-010	15 0.5625 0.6250	40 1.5748	22.5 0.8858	13 0.5118	0.6 0.024	6.5 0.256	16 0.630	5 0.197	M6x0.75 1/4-28UNF	24.4 0.9606	
17 11/16	AR203 AR203-011	17 0.6875	40 1.5748	22.5 0.8858	13 0.5118	0.6 0.024	6.5 0.256	16 0.630	5 0.197	M6x0.75 1/4-28UNF	24.4 0.9606	
20 3/4	AR204 AR204-012	20 0.7500	47 1.8504	25.5 1.0039	15 0.5906	1 0.039	7.5 0.295	18 0.709	5 0.197	M6x0.75 1/4-28UNF	29.6 1.1654	
25 13/16 7/8 15/16	AR205 AR205-013 AR205-014 AR205-015	25 0.8125 0.8750 0.9375	52 2.0472	27 1.0630	15 0.5906	1 0.039	7.5 0.295	19.5 0.768	5 0.197	M6x0.75 1/4-28UNF	33.9 1.3346	
1 AR205-100		1.0000										
30 1 1/16 1 1/8 1 3/16 1 1/4	AR206 AR206-101 AR206-102 AR206-103 AR206-104	30 1.0625 1.1250 1.1875 1.2500	62 2.4409	30 1.1811	18 0.7087	1 0.039	9 0.354	21 0.827	5 0.197	M6x0.75 1/4-28UNF	40.8 1.6063	
35 1 1/4 1 5/16 1 3/8 1 7/16	AR207 AR207-104 AR207-105 AR207-106 AR207-107	35 1.2500 1.3125 1.3750 1.4375	72 2.8346	35 1.3780	19 0.7480	1.5 0.059	9.5 0.374	25.5 1.004	6 0.236	M6x0.75 1/4-28UNF	46.8 1.8425	
40 1 1/2 1 9/16	AR208 AR208-108 AR208-109	40 1.5000 1.5625	80 3.1496	40 1.5748	22 0.8661	1.5 0.059	11.0 0.433	29 1.142	8 0.315	M8x1 5/16-24UNF	53 2.0866	

Note (1) If relubricatable type is needed, please order with suffix "D1".

Basic load ratings		Mass
N lbf		kg lb
dynamic <i>C_r</i>	static <i>C_{or}</i>	
9 600	4 600	0.11
2 160	1 030	0.24
9 600	4 600	0.10
2 160	1 030	0.23
		0.22
9 600	4 600	0.09
2 160	1 030	0.20
12 800	6 650	0.14
2 890	1 500	0.31
14 000	7 850	0.17
		0.44
		0.42
3 150	1 770	0.40
		0.37
19 500	11 300	0.26
		0.63
		0.61
4 400	2 540	0.59
		0.57
25 700	15 300	0.39
		1.10
		0.97
5 750	3 450	0.85
		0.73
29 100	17 800	0.54
		1.24
6 550	4 000	1.15

Ball bearings Set screw type

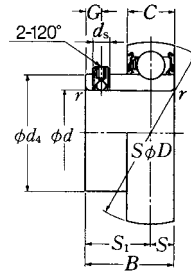

Shaft dia. mm inch	Bearing (*) number	Nominal dimensions									
		d	D	B	C	r mm min.	S inch	S_1	G	d_s	d_4
45 1 5/8	AR209	45	85	41.5	22	1.5	11	30.5	8	M8x1	57.5
	AR209-110	1.6250									
	AR209-111	1.6875	3.3465	1.6339	0.8661	0.059	0.433	1.201	0.315	5/16-24UNF	2.2638
	AR209-112	1.7500									
50 1 13/16	AR210	80	90	43	22	1.5	11	32	9	M8x1	62.4
	AR210-113	1.8125									
	AR210-114	1.8750	3.5433	1.6929	0.8661	0.059	0.433	1.260	0.354	5/16-24UNF	2.4567
	AR210-115	1.9375									
2 1 15/16	AR210-200	2.0000									

Note (*) If relubricatable type is needed, please order with "D1".

Basic load ratings		Mass
dynamic C_r	static C_{0r}	kg lb
32 500	20 400	0.61
		1.54
7 350	4 600	1.46
		1.39
35 000	23 200	0.70
		1.76
7 900	5 200	1.68
		1.59
		1.50

Ball bearings Eccentric locking collar type

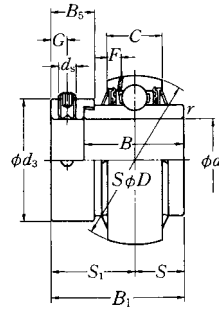

Shaft dia. mm inch	Bearing (1) number	Nominal dimensions										
		<i>d</i>	<i>D</i>	<i>B</i> ₁	<i>B</i>	<i>C</i>	<i>r</i> mm min.	<i>S</i>	<i>S</i> ₁	<i>G</i>	<i>d</i> _s	<i>d</i> ₃
20 3/4	UEL204D1W3	20	47	43.7	34.2	17	1	17.1	26.6	4.8	M6x0.75	33
	UEL204-012D1W3	0.7500	1.8504	1.720	1.3465	0.6693	0.039	0.673	1.047	0.189	1/4-28UNF	1.299
25 13/16 7/8 15/16	UEL205D1W3	25	52	44.4	34.9	17	1	17.45	26.9	4.8	M6x0.75	38
	UEL205-013D1W3	0.8125										
	UEL205-014D1W3	0.8750	2.0472	1.748	1.3740	0.6693	0.039	0.687	1.059	0.189	1/4-28UNF	1.496
	UEL205-015D1W3	0.9375										
1	UEL205-100D1W3	1.0000										
30 1 1/16 1 1/8 1 3/16 1 1/4	UEL206D1W3	30	62	48.4	36.5	19	1	18.25	30.1	6	M8x1	44.5
	UEL206-101D1W3	1.0625										
	UEL206-102D1W3	1.1250	2.4409	1.906	1.4370	0.7480	0.039	0.719	1.185	0.236	5/16-24UNF	1.752
	UEL206-103D1W3	1.1875										
	UEL206-104D1W3	1.2500										
35 1 1/4 1 5/16 1 3/8 1 7/16	UEL207D1W3	35	72	51.1	37.6	20	1.5	18.8	32.3	6.8	M10x1.25	55.5
	UEL207-104D1W3	1.2500										
	UEL207-105D1W3	1.3125	2.8346	2.012	1.4803	0.7874	0.059	0.740	1.272	0.268	3/8-24UNF	2.185
	UEL207-106D1W3	1.3750										
	UEL207-107D1W3	1.4375										
40 1 1/2 1 9/16	UEL208D1W3	40	80	56.3	42.8	21	1.5	21.4	34.9	6.8	M10x1.25	60
	UEL208-108D1W3	1.5000	3.1496	2.217	1.6850	0.8268	0.059	0.843	1.374	0.268	3/8-24UNF	2.362
	UEL208-109D1W3	1.5625										
45 1 5/8 1 11/16 1 3/4	UEL209D1W3	45	85	56.3	42.8	22	1.5	21.4	34.9	6.8	M10x1.25	63.5
	UEL209-110D1W3	1.6250										
	UEL209-111D1W3	1.6875	3.3465	2.217	1.6850	0.8661	0.059	0.843	1.374	0.268	3/8-24UNF	2.500
	UEL209-112D1W3	1.7500										

Note (1) These numbers indicate relubricatable type. If maintenance free type is needed, please order without suffix "D1".

Nominal dimensions mm inch		Basic load ratings N lbf		Mass kg lb
<i>B</i> ₅	<i>F</i>	dynamic <i>C</i> _r	static <i>C</i> _{or}	
13.5	4.7	12 800	6 650	0.23
0.531	0.185	2 890	1 500	0.45
13.5	4.5	14 000	7 850	0.27
				0.61
0.531	0.177	3 150	1 770	0.58
				0.55
				0.51
15.9	4.6	19 500	11 300	0.45
				0.94
0.626	0.181	4 400	2 540	0.89
				0.84
				0.80
17.5	4.6	25 700	15 300	0.60
				1.45
0.689	0.181	5 750	3 450	1.40
				1.35
				1.28
18.3	4.5	29 100	17 800	0.78
				1.90
0.720	0.177	6 550	4 000	1.82
				1.82
18.3	4.9	32 500	20 400	0.80
				2.05
0.720	0.193	7 350	4 600	1.97
				1.88

Ball bearings Eccentric locking collar type

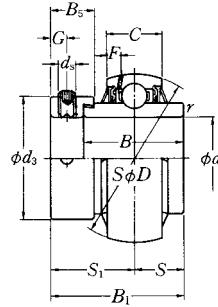

Shaft dia. mm inch	Bearing (1) number	Nominal dimensions										
		<i>d</i>	<i>D</i>	<i>B</i> ₁	<i>B</i>	<i>C</i>	<i>r</i> min.	<i>S</i>	<i>S</i> ₁	<i>G</i>	<i>d</i> _s	<i>d</i> ₃
50 1 13/16 1 7/8 1 15/16 2	UEL210D1W3 UEL210-113D1W3 UEL210-114D1W3 UEL210-115D1W3 UEL210-200D1W3	50 1.8125 1.8750 1.9375 2.0000	90 3.5433	62.7 2.469	49.2 1.9370	24 0.9449	1.5 0.059	24.6 0.969	38.1 1.500	6.8 0.268	M10x1.25 3/8-24UNF	69.5 2.736
55 2 2 1/16 2 1/8 2 3/16	UEL211D1W3 UEL211-200D1W3 UEL211-201D1W3 UEL211-202D1W3 UEL211-203D1W3	55 2.0000 2.0625 2.1250 2.1875	100 3.9370	71.4 2.811	55.5 2.1850	25 0.9843	2 0.079	27.75 1.093	43.6 1.717	8 0.315	M10x1.25 3/8-24UNF	76 2.992
60 2 1/4 2 5/16 2 3/8 2 7/16	UEL212D1W3 UEL212-204D1W3 UEL212-205D1W3 UEL212-206D1W3 UEL212-207D1W3	60 2.2500 2.3125 2.3750 2.4375	110 4.3307	77.8 3.063	61.9 2.4370	27 1.0630	2 0.079	30.95 1.219	46.8 1.843	8 0.315	M10x1.25 3/8-24UNF	84 3.307
65 2 1/2 2 9/16	UEL213D1W3 UEL213-208D1W3 UEL213-209D1W3	65 2.5000 2.5625	120 4.7244	85.7 3.374	68.3 2.6890	32 1.2598	2 0.079	34.15 1.344	51.55 2.030	8.7 0.343	M10x1.25 3/8-24UNF	97 3.819
70 2 5/8 2 11/16 2 3/4	UEL214D1W3 UEL214-210D1W3 UEL214-211D1W3 UEL214-212D1W3	70 2.6250 2.6875 2.7500	125 4.9213	85.7 3.374	68.3 2.6890	33 1.2992	2 0.079	34.15 1.344	51.55 2.030	8.7 0.343	M10x1.25 3/8-24UNF	97 3.819
75 2 13/16 2 7/8 2 15/16 3	UEL215D1W3 UEL215-213D1W3 UEL215-214D1W3 UEL215-215D1W3 UEL215-300D1W3	75 2.8125 2.8750 2.9375 3.0000	130 5.1181	92 3.622	74.6 2.9370	34 1.3386	2 0.079	37.3 1.469	54.7 2.154	8.7 0.343	M10x1.25 3/8-24UNF	102 4.016

Note (1) These numbers indicate relubricatable type. If maintenance free type is needed, please order without suffix "D1".

Nominal dimensions mm inch		Basic load ratings N lbf		Mass kg lb
<i>B</i> ₅	<i>F</i>	dynamic <i>C</i> _r	static <i>C</i> _{or}	
18.3 0.720	5.9 0.232	35 000 7 900	23 200 5 200	0.96 2.46 2.36 2.25 2.09
20.7 0.815	6.0 0.236	43 500 9 750	29 200 6 550	1.32 3.28 3.12 3.02 2.90
22.3 0.878	6.2 0.244	52 500 11 800	36 000 8 150	1.79 4.38 4.22 4.05 3.88
23.8 0.937	8.7 0.343	57 500 12 900	40 000 9 000	2.54 5.47 5.30
23.8 0.937	8.8 0.346	62 000 14 000	44 000 9 900	2.47 5.67 5.45 5.18
23.8 0.937	9.0 0.354	66 000 14 900	49 500 11 100	2.68 6.39 6.15 5.91 5.60

Ball bearings Eccentric locking collar type

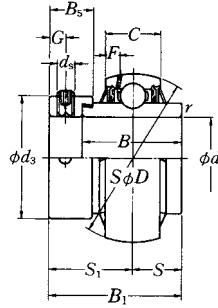

Shaft dia. mm inch	Bearing (1) number	Nominal dimensions										
		<i>d</i>	<i>D</i>	<i>B</i> ₁	<i>B</i>	<i>C</i>	<i>r</i> mm inch min.	<i>S</i>	<i>S</i> ₁	<i>G</i>	<i>d</i> _s	<i>d</i> ₃
25	UEL305D1W3	25	62	46.8	34.9	20	1.5	16.7	30.1	6	M8×1	42.8
¹³ / ₁₆	UEL305-013D1W3	0.8125										
⁷ / ₈	UEL305-014D1W3	0.8750	2.4409	1.843	1.3740	0.7874	0.059	0.657	1.185	0.236	⁵ / ₁₆ -24UNF	1.685
¹⁵ / ₁₆	UEL305-015D1W3	0.9375										
1	UEL305-100D1W3	1.0000										
30	UEL306D1W3	30	72	50	36.5	23	1.5	17.5	32.5	6.7	M8×1	50
¹ / ₁₆	UEL306-101D1W3	1.0625										
¹ / ₈	UEL306-102D1W3	1.1250	2.8346	1.969	1.4370	0.9055	0.059	0.689	1.280	0.264	⁵ / ₁₆ -24UNF	1.969
³ / ₁₆	UEL306-103D1W3	1.1875										
35	UEL307D1W3	35	80	51.6	38.1	25	2	18.3	33.3	6.7	M8×1	55
¹ / ₄	UEL307-104D1W3	1.2500										
⁵ / ₁₆	UEL307-105D1W3	1.3125	3.1496	2.031	1.5000	0.9843	0.079	0.720	1.311	0.264	⁵ / ₁₆ -24UNF	2.165
³ / ₈	UEL307-106D1W3	1.3750										
⁷ / ₁₆	UEL307-107D1W3	1.4375										
40	UEL308D1W3	40	90	57.1	41.3	27	2	19.8	37.3	8	M10×1.25	63.5
¹ / ₂	UEL308-108D1W3	1.5000	3.5433	2.248	1.6260	1.0630	0.079	0.780	1.469	0.315	³ / ₈ -24UNF	2.500
⁹ / ₁₆	UEL308-109D1W3	1.5625										
45	UEL309D1W3	45	100	58.7	42.9	29	2	19.8	38.9	8	M10×1.25	70
⁵ / ₈	UEL309-110D1W3	1.6250										
¹¹ / ₁₆	UEL309-111D1W3	1.6875	3.9370	2.311	1.6890	1.1417	0.079	0.780	1.531	0.315	³ / ₈ -24UNF	2.756
³ / ₄	UEL309-112D1W3	1.7500										
50	UEL310D1W3	50	110	66.6	49.2	32	2.5	24.6	42	8.7	M10×1.25	76.2
¹³ / ₁₆	UEL310-113D1W3	1.8125										
⁷ / ₈	UEL310-114D1W3	1.8750	4.3307	2.622	1.9370	1.2598	0.098	0.969	1.654	0.343	³ / ₈ -24UNF	3.000
¹⁵ / ₁₆	UEL310-115D1W3	1.9375										

Note (1) These numbers indicate relubricatable type. If maintenance free type is needed, please order without suffix "D1".

Nominal dimensions mm inch		Basic load ratings N lbf		Mass kg lb
<i>B</i> ₅	<i>F</i>	dynamic <i>C</i> _r	static <i>C</i> _{or}	
15.9	5.0	21 200	10 900	0.43 1.09
0.626	0.197	4 750	2 460	1.05 1.01
17.5	5.9	26 700	15 000	0.69 1.57
0.689	0.232	6 000	3 400	1.51 1.45
17.5	6.8	33 500	19 100	0.78 1.92
0.689	0.268	7 500	4 300	1.84 1.77
20.6	7.4	40 500	24 000	1.08 2.58
0.811	0.291	9 150	5 400	2.49 2.49
20.6	7.4	53 000	32 000	1.40 3.36
0.811	0.291	11 900	7 200	3.26 3.15
22.2	8.1	62 000	38 500	1.84 4.40
0.874	0.319	13 900	8 600	4.29 4.15

Ball bearings Eccentric locking collar type

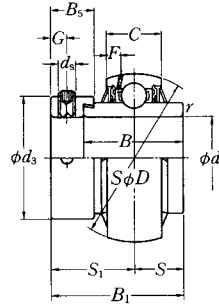

Shaft dia. mm inch	Bearing (1) number	Nominal dimensions										
		<i>d</i>	<i>D</i>	<i>B</i> ₁	<i>B</i>	<i>C</i>	<i>r</i> mm inch min.	<i>S</i>	<i>S</i> ₁	<i>G</i>	<i>d</i> _s	<i>d</i> ₃
55	UEL311D1W3	55	120	73	55.6	34	2.5	27.8	45.2	8.7	M10x1.25	83
2	UEL311-200D1W3	2.0000										
2 1/16	UEL311-201D1W3	2.0625	4.7244	2.874	2.1890	1.3386	0.098	1.094	1.780	0.343	3/8-24UNF	3.268
2 1/8	UEL311-202D1W3	2.1250										
2 3/16	UEL311-203D1W3	2.1875										
60	UEL312D1W3	60	130	79.4	61.9	36	2.5	30.95	48.45	8.7	M10x1.25	89
2 1/4	UEL312-204D1W3	2.2500										
2 5/16	UEL312-205D1W3	2.3125	5.1181	3.126	2.4370	1.1473	0.098	1.219	1.907	0.343	3/8-24UNF	3.504
2 3/8	UEL312-206D1W3	2.3750										
2 7/16	UEL312-207D1W3	2.4375										
65	UEL313D1W3	65	140	85.7	65.1	39	2.5	32.55	53.15	10.3	M12x1.5	97
2 1/2	UEL313-208D1W3	2.5000	5.5118	3.374	2.5630	1.5354	0.098	1.281	2.093	0.406	1/2-20UNF	3.819
2 9/16	UEL313-209D1W3	2.5625										
70	UEL314D1W3	70	150	92.1	68.3	41	2.5	34.15	57.95	10.3	M12x1.5	102
2 5/8	UEL314-210D1W3	2.6250										
2 11/16	UEL314-211D1W3	2.6875	5.9055	3.626	2.6890	1.6142	0.098	1.344	2.281	0.406	1/2-20UNF	4.016
2 3/4	UEL314-212D1W3	2.7500										
75	UEL315D1W3	75	160	100	74.6	43	2.5	37.3	62.7	12.7	M16x1.5	113
2 13/16	UEL315-213D1W3	2.8125										
2 7/8	UEL315-214D1W3	2.8750	6.2992	3.937	2.9370	1.6929	0.098	1.469	2.469	0.500	5/8-18UNF	4.449
2 15/16	UEL315-215D1W3	2.9375										
3	UEL315-300D1W3	3.0000										
80	UEL316D1W3	80	170	106.4	81	45	2.5	40.5	65.9	12.7	M16x1.5	119
3 1/16	UEL316-301D1W3	3.0625										
3 1/8	UEL316-302D1W3	3.1250	6.6929	4.189	3.1890	1.7717	0.098	1.594	2.594	0.500	5/8-18UNF	4.685
3 3/16	UEL316-303D1W3	3.1875										

Note (1) These numbers indicate relubricatable type. If maintenance free type is needed, please order without suffix "D1".

Nominal dimensions mm inch		Basic load ratings N lbf		Mass kg lb
<i>B</i> ₅	<i>F</i>	dynamic <i>C</i> _r	static <i>C</i> _{or}	
22.2	8.5	71 500	45 000	2.36
				5.58
0.874	0.335	16 100	10 100	5.39
				5.25
				5.08
23.9	9.0	82 000	52 000	2.94
				6.80
0.941	0.354	18 400	11 700	6.65
				6.48
				6.19
27	10.1	92 500	60 000	3.67
				8.49
1.063	0.398	20 800	13 400	8.27
30.2	10.5	104 000	68 000	4.40
				10.4
1.189	0.413	23 400	15 300	10.2
				9.96
31.8	11.0	113 000	77 000	5.34
				13.2
1.252	0.433	25 500	17 400	12.9
				12.7
				12.5
31.8	11.4	123 000	86 500	6.70
				14.9
1.252	0.449	27 600	19 500	14.8
				14.6

Ball bearings Eccentric locking collar type

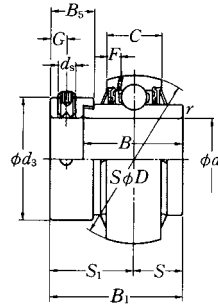

Shaft dia. mm inch	Bearing (1) number	Nominal dimensions										
		<i>d</i>	<i>D</i>	<i>B</i> ₁	<i>B</i>	<i>C</i>	<i>r</i> mm inch min.	<i>S</i>	<i>S</i> ₁	<i>G</i>	<i>d</i> _s	<i>d</i> ₃
85 3 1/4	UEL317D1W3	85	180	109.5	84.1	47	3	42.05	67.45	12.7	M16×1.5	127
	UEL317-304D1W3	3.2500										
3 5/16	UEL317-305D1W3	3.3125	7.0866	4.311	3.3110	1.8504	0.118	1.656	2.656	0.500	5/8-18UNF	5.000
3 7/16	UEL317-307D1W3	3.4375										
90 3 7/16	UEL318D1W3	90	190	115.9	87.3	49	3	43.65	72.25	14.3	M20×1.5	133
	UEL318-307D1W3	3.4375										
3 1/2	UEL318-308D1W3	3.5000	7.4803	4.563	3.4370	1.9291	0.118	1.719	2.844	0.563	3/4-16UNF	5.236
95 3 5/8	UEL319D1W3	95	200	122.3	93.7	51	3	38.9	83.4	14.3	M20×1.5	140
	UEL319-310D1W3	3.6250										
3 11/16	UEL319-311D1W3	3.6875	7.8740	4.815	3.6890	2.0079	0.118	1.531	3.283	0.563	3/4-16UNF	5.512
3 3/4	UEL319-312D1W3	3.7500										
100 3 13/16	UEL320D1W3	100	215	128.6	100	55	3	50	78.6	14.3	M20×1.5	146
	UEL320-313D1W3	3.8125										
3 7/8	UEL320-314D1W3	3.8750	8.4646	5.063	3.9370	2.1654	0.118	1.969	3.094	0.563	3/4-16UNF	5.748
3 15/16	UEL320-315D1W3	3.9375										
4	UEL320-400D1W3	4.0000										
105 4 1/8	UEL321D1W3	105	225	139.7	104.8	57	3	48.4	91.3	17.5	M20×1.5	157
110 4 3/8	UEL322D1W3	110	240	141.3	106.4	59	3	49.2	92.1	17.5	M20×1.5	168

Note (1) These numbers indicate relubricatable type. If maintenance free type is needed, please order without suffix "D1".

Nominal dimensions mm inch		Basic load ratings N lbf		Mass kg lb
<i>B</i> ₅	<i>F</i>	dynamic <i>C</i> _r	static <i>C</i> _{or}	
31.8	12.0	133 000	97 000	8.00 18.0
1.252	0.472	29 800	21 800	17.7 17.0
36.5	12.3	143 000	107 000	9.10 20.7
1.437	0.484	32 000	24 100	20.2
36.5	12.8	153 000	119 000	10.4 23.4
1.437	0.504	34 500	26 600	23.0 22.6
36.5	13.5	173 000	141 000	13.0 28.5
1.437	0.531	39 000	31 500	28.0 27.6
42.8	13.9	184 000	153 000	14.6 27.0
42.8	13.9	205 000	179 000	17.2

Ball bearings Eccentric locking collar type

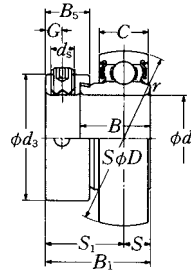

Shaft dia. mm inch	Bearing (1) number	Nominal dimensions										
		<i>d</i>	<i>D</i>	<i>B</i> ₁	<i>B</i>	<i>C</i>	<i>r</i> mm inch min.	<i>S</i>	<i>S</i> ₁	<i>G</i>	<i>d</i> ₃	<i>d</i> ₃
12 1/2	AEL201W3 AEL201-008W3	12 0.5000	40 1.5748	28.6 1.126	19 0.7480	12 0.4724	0.6 0.024	6.5 0.256	22.1 0.870	4.8 0.189	M6×0.75 1/4-28UNF	29 1.142
15 9/16 5/8	AEL202W3 AEL202-009W3 AEL202-010W3	15 0.5625 0.6250	40 1.5748	28.6 1.126	19 0.7480	12 0.4724	0.6 0.024	6.5 0.256	22.1 0.870	4.8 0.189	M6×0.75 1/4-28UNF	29 1.142
17 11/16	AEL203W3 AEL203-011W3	17 0.6875	40 1.5748	28.6 1.126	19 0.7480	12 0.4724	0.6 0.024	6.5 0.256	22.1 0.870	4.8 0.189	M6×0.75 1/4-28UNF	29 1.142
20 3/4	AEL204W3 AEL204-012W3	20 0.7500	47 1.8504	31 1.220	21.5 0.8465	14 0.5512	1 0.039	7.5 0.295	23.5 0.925	4.8 0.189	M6×0.75 1/4-28UNF	33 1.299
25 13/16 7/8 15/16 1	AEL205W3 AEL205-013W3 AEL205-014W3 AEL205-015W3 AEL205-100W3	25 0.8125 0.8750 0.9375 1.0000	52 2.0472	31 1.220	21.5 0.8465	15 0.5906	1 0.039	7.5 0.295	23.5 0.925	4.8 0.189	M6×0.75 1/4-28UNF	38 1.496
30 1 1/16 1 1/8 1 3/16 1 1/4	AEL206W3 AEL206-101W3 AEL206-102W3 AEL206-103W3 AEL206-104W3	30 1.0625 1.1250 1.1875 1.2500	62 2.4409	35.7 1.406	23.8 0.9370	16 0.6299	1 0.039	9 0.354	26.7 1.051	6 0.236	M8×1 5/16-24UNF	44.5 1.752
35 1 1/4 1 5/16 1 3/8 1 7/16	AEL207W3 AEL207-104W3 AEL207-105W3 AEL207-106W3 AEL207-107W3	35 1.2500 1.3125 1.3750 1.4375	72 2.8346	38.9 1.531	25.4 1.0000	17 0.6693	1.5 0.059	9.5 0.374	29.4 1.157	6.8 0.268	M10×1.25 3/8-24UNF	55.5 2.185
40 1 1/2 1 9/16	AEL208W3 AEL208-108W3 AEL208-109W3	40 1.5000 1.5625	80 3.1496	43.7 1.720	30.2 1.1890	18 0.7087	1.5 0.059	11 0.433	32.7 1.287	6.8 0.268	M10×1.25 3/8-24UNF	60 2.362

Note (1) If relubricatable type is needed, please order with suffix "D1".

Nominal dimensions mm inch <i>B</i> ₅	Basic load ratings		Mass kg lb
	dynamic <i>C</i> _r	static <i>C</i> _{0r}	
13.6 0.535	9 600 2 160	4 600 1 030	0.12 0.26
13.6 0.535	9 600 2 160	4 600 1 030	0.11 0.26 0.24
13.6 0.535	9 600 2 160	4 600 1 030	0.10 0.23
13.5 0.531	12 800 2 890	6 650 1 500	0.17 0.35
13.5 0.531	14 000 3 150	7 850 1 770	0.22 0.51 0.48 0.45 0.42
15.9 0.626	19 500 4 400	11 300 2 540	0.31 0.74 0.73 0.66 0.61
17.5 0.689	25 700 5 750	15 300 3 450	0.50 1.15 1.10 1.04 0.98
18.3 0.720	29 100 6 550	17 800 4 000	0.66 1.41 1.34

Ball bearings Eccentric locking collar type

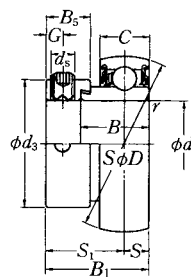

Shaft dia. mm inch	Bearing (1) number	Nominal dimensions										
		<i>d</i>	<i>D</i>	<i>B</i> ₁	<i>B</i>	<i>C</i>	<i>r</i> mm inch min.	<i>S</i>	<i>S</i> ₁	<i>G</i>	<i>d</i> _s	<i>d</i> ₃
12 1/2	JEL201W3 JEL201-008W3	12 0.5000	40 1.5748	28.6 1.126	19 0.7480	13 0.5118	0.6 0.024	6.5 0.256	22.1 0.870	4.8 0.189	M6×0.75 1/4-28UNF	29 1.142
15 9/16 5/8	JEL202W3 JEL202-009W3 JEL202-010W3	15 0.5625 0.6250	40 1.5748	28.6 1.126	19 0.7480	13 0.5118	0.6 0.024	6.5 0.256	22.1 0.870	4.8 0.189	M6×0.75 1/4-28UNF	29 1.142
17 11/16	JEL203W3 JEL203-011W3	17 0.6875	40 1.5748	28.6 1.126	19 0.7480	13 0.5118	0.6 0.024	6.5 0.256	22.1 0.870	4.8 0.189	M6×0.75 1/4-28UNF	29 1.142
20 3/4	JEL204W3 JEL204-012W3	20 0.7500	47 1.8504	31 1.220	21.5 0.8465	15 0.5906	1 0.039	7.5 0.295	23.5 0.925	4.8 0.189	M6×0.75 1/4-28UNF	33 1.299
25 13/16 7/8 15/16 1	JEL205W3 JEL205-013W3 JEL205-014W3 JEL205-015W3 JEL205-100W3	25 0.8125 0.8750 0.9375 1.0000	52 2.0472	31 1.220	21.5 0.8465	15 0.5906	1 0.039	7.5 0.295	23.5 0.925	4.8 0.189	M6×0.75 1/4-28UNF	38 1.496
30 1 1/16 1 1/8 1 3/16 1 1/4	JEL206W3 JEL206-101W3 JEL206-102W3 JEL206-103W3 JEL206-104W3	30 1.0625 1.1250 1.1875 1.2500	62 2.4409	35.7 1.406	23.8 0.9370	18 0.7087	1 0.039	9 0.354	26.7 1.051	6 0.236	M8×1 5/16-24UNF	44.5 1.752
35 1 1/4 1 5/16 1 3/8 1 7/16	JEL207W3 JEL207-104W3 JEL207-105W3 JEL207-106W3 JEL207-107W3	35 1.2500 1.3125 1.3750 1.4375	72 2.8346	38.9 1.531	25.4 1.0000	19 0.7480	1.5 0.059	9.5 0.374	29.4 1.157	6.8 0.268	M10×1.25 3/8-24UNF	55.5 2.185
40 1 1/2 1 9/16	JEL208W3 JEL208-108W3 JEL208-109W3	40 1.5000 1.5625	80 3.1496	43.7 1.720	30.2 1.1890	22 0.8661	1.5 0.059	11 0.433	32.7 1.287	6.8 0.268	M10×1.25 3/8-24UNF	60 2.362

Note (1) If relubricatable type is needed, please order with suffix "D1".

Nominal dimensions mm inch <i>B</i> ₅	Basic load ratings		Mass kg lb
	dynamic <i>C</i> _r	static <i>C</i> _{0r}	
13.6 0.535	9 600 2 160	4 600 1 030	0.12 0.25
13.6 0.535	9 600 2 160	4 600 1 030	0.10 0.24 0.22
13.6 0.535	9 600 2 160	4 600 1 030	0.09 0.20
13.5 0.531	12 800 2 890	6 650 1 500	0.16 0.37
13.5 0.531	14 000 3 150	7 850 1 770	0.19 0.47 0.44 0.41
15.9 0.626	19 500 4 400	11 300 2 540	0.33 0.78 0.73 0.69 0.64
17.5 0.689	25 700 5 750	15 300 3 450	0.50 1.22 1.16 1.11 1.05
18.3 0.720	29 100 6 550	17 800 4 000	0.65 1.53 1.46

Ball bearings Eccentric locking collar type

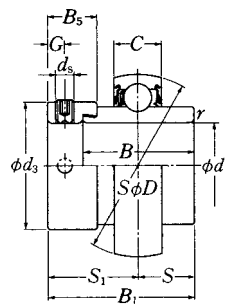

Shaft dia. mm inch	Bearing (1) number	Nominal dimensions										
		<i>d</i>	<i>D</i>	<i>B</i> ₁	<i>B</i>	<i>C</i>	mm <i>r</i> min.	inch <i>S</i>	<i>S</i> ₁	<i>G</i>	<i>d</i> _s	<i>d</i> ₃
20 3/4	REL204W3 REL204-012W3	20 0.7500	47 1.8504	43.7 1.720	34.2 1.3465	15 0.5906	1 0.039	17.1 0.673	26.6 1.047	4.8 0.189	M6x0.75 1/4-28UNF	33.0 1.299
25 13/16 7/8 15/16	REL205W3 REL205-013W3 REL205-014W3 REL205-015W3	25 0.8125 0.8750 0.9375	52 2.0472	44.4 1.748	34.9 1.3740	15 0.5906	1 0.039	17.45 0.687	26.9 1.059	4.8 0.189	M6x0.75 1/4-28UNF	38.0 1.496
1	REL205-100W3	1.0000										
30 1 1/16 1 1/8 1 3/16 1 1/4	REL206W3 REL206-101W3 REL206-102W3 REL206-103W3 REL206-104W3	30 1.0625 1.1250 1.1875 1.2500	62 2.4409	48.4 1.906	36.5 1.4370	18 0.7087	1 0.039	18.25 0.719	30.1 1.185	6 0.236	M8x1 5/16-24UNF	44.5 1.752
35 1 1/4 1 5/16 1 3/8 1 7/16	REL207W3 REL207-104W3 REL207-105W3 REL207-106W3 REL207-107W3	35 1.2500 1.3125 1.3750 1.4375	72 2.8346	51.1 2.012	37.6 1.4803	19 0.7480	1.5 0.059	18.8 0.740	32.3 1.272	6.8 0.268	M10x1.25 3/8-24UNF	55.5 2.185
40 1 1/2 1 9/16	REL208W3 REL208-108W3 REL208-109W3	40 1.5000 1.5625	80 3.1496	56.3 2.217	42.8 1.6850	22 0.8661	1.5 0.059	21.4 0.843	34.9 1.374	6.8 0.268	M10x1.25 3/8-24UNF	60.0 2.362
45 1 5/8 1 11/16 1 3/4	REL209W3 REL209-110W3 REL209-111W3 REL209-112W3	45 1.6250 1.6875 1.7500	85 3.3465	56.3 2.217	42.8 1.6850	22 0.8661	1.5 0.059	21.4 0.843	34.9 1.374	6.8 0.268	M10x1.25 3/8-24UNF	63.5 2.500

Note (1) If relubricatable type is needed, please order with suffix "D1".

Nominal dimensions mm inch <i>B</i> ₅	Basic load ratings		Mass kg lb
	N dynamic <i>C</i> _r	lbf static <i>C</i> _{0r}	
13.5 0.531	12 800 2 890	6 650 1 500	0.22 0.43
13.5 0.531	14 000 3 150	7 850 1 770	0.26 0.56 0.53 0.49
15.9 0.626	19 500 4 400	11 300 2 540	0.39 0.92 0.87 0.82 0.78
17.5 0.689	25 700 5 750	15 300 3 450	0.59 1.41 1.36 1.31 1.24
18.3 0.720	29 100 6 550	17 800 4 000	0.76 1.88 1.80
18.3 0.720	32 500 7 350	20 400 4 600	0.78 2.01 1.93 1.84

Ball bearings Eccentric locking collar type

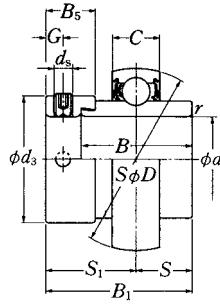

Shaft dia. mm inch	Bearing (1) number	Nominal dimensions										
		<i>d</i>	<i>D</i>	<i>B</i> ₁	<i>B</i>	<i>C</i>	<i>r</i> mm inch min.	<i>S</i>	<i>S</i> ₁	<i>G</i>	<i>d</i> _s	<i>d</i> ₃
50 1 13/16	REL210W3	50	90	62.7	49.2	22	1.5	24.6	38.1	6.8	M10x1.25	69.5
	REL210-113W3	1.8125										
	REL210-114W3	1.8750	3.5433	2.469	1.9370	0.8661	0.059	0.969	1.500	0.268	3/8-24UNF	2.736
	REL210-115W3	1.9375										
2	REL210-200W3	2.0000										
55 2	REL211W3	55	100	71.4	55.5	24	2	27.75	43.6	8	M10x1.25	76
	REL211-200W3	2.0000										
	REL211-201W3	2.0625	3.9370	2.811	2.1850	0.9449	0.079	1.093	1.717	0.315	3/8-24UNF	2.992
	REL211-202W3	2.1250										
	REL211-203W3	2.1875										
60 2 1/4	REL212W3	60	110	77.8	61.9	27	2	30.95	46.8	8	M10x1.25	84
	REL212-204W3	2.2500										
	REL212-205W3	2.3125	4.3307	3.063	2.4370	1.0630	0.079	1.219	1.843	0.315	3/8-24UNF	3.307
	REL212-206W3	2.3750										
	REL212-207W3	2.4375										

Note (1) If relubricatable type is needed, please order with suffix "D1".

Nominal dimensions mm inch <i>B</i> ₅	Basic load ratings		Mass kg lb
	dynamic <i>C</i> _r	static <i>C</i> _{0r}	
18.3	35 000	23 200	0.96 2.42
0.720	7 900	5 200	2.32 2.21
			2.05
20.7	43 500	29 200	1.28 3.21
0.815	9 750	6 550	3.05 2.95
			2.83
22.3	52 500	36 000	1.83 4.29
0.878	11 800	8 150	4.13 3.96
			3.79

Ball bearings Adapter type

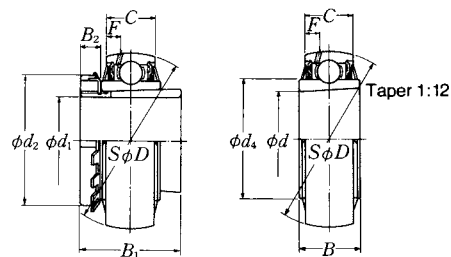

UK2...D1;H, HA, HE, HS

UK2...D1

Shaft dia. mm inch	Bearing ⁽¹⁾ (²)(³) number	Nominal dimensions									
		mm inch									
		<i>d</i>	<i>D</i>	<i>B</i>	<i>C</i>	<i>d</i> ₄	<i>d</i> ₁	<i>B</i> ₁	<i>B</i> ₂	<i>d</i> ₂	<i>F</i>
20 3/4	UK205D1;H2305X UK205D1;HE2305	25 0.9843	52 2.0472	23 0.9055	17 0.6693	33.9 1.335	20 3/4	35 1.378	8 0.315	38 1.496	4.5 0.177
25 7/8 1	UK206D1;H2306X UK206D1;HS2306 UK206D1;HE2306X	30 1.1811	62 2.4409	26 1.0236	19 0.7480	40.8 1.606	25 7/8 1	38 1.496	8 0.315	45 1.772	4.6 0.181
30 1 1/8	UK207D1;H2307X UK207D1;HS2307	35 1.3780	72 2.8346	29 1.1417	20 0.7874	46.8 1.843	30 1 1/8	43 1.693	9 0.354	52 2.047	4.6 0.181
35 1 1/4 1 3/8	UK208D1;H2308X UK208D1;HE2308X UK208D1;HS2308X	40 1.5748	80 3.1496	31 1.2205	21 0.8268	53 2.087	35 1 1/4 1 3/8	46 1.811	10 0.394	58 2.283	4.5 0.177
40 1 7/16 1 1/2 1 5/8	UK209D1;H2309X UK209D1;HA2309 UK209D1;HE2309X UK209D1;HS2309X	45 1.7717	85 3.3465	31 1.2205	22 0.8661	57.5 2.264	40 1 7/16 1 1/2 1 5/8	50 1.969	11 0.433	65 2.559	4.9 0.193
45 1 5/8 1 11/16 1 3/4	UK210D1;H2310X UK210D1;HS2310 UK210D1;HA2310 UK210D1;HE2310X	50 1.9685	90 3.5433	32 1.2598	24 0.9449	62.4 2.457	45 1 5/8 1 11/16 1 3/4	55 2.165	12 0.472	70 2.756	5.9 0.232
50 1 7/8 1 15/16 2	UK211D1;H2311X UK211D1;HS2311 UK211D1;HA2311 UK211D1;HE2311XY	55 2.1654	100 3.9370	35 1.3780	25 0.9843	69 2.717	50 1 7/8 1 15/16 2	59 2.323	12 0.472	75 2.953	6.0 0.236
55 2 1/8	UK212D1;H2312X UK212D1;HS2312	60 2.3622	110 4.3307	38 1.4961	27 1.0630	77 3.031	55 2 1/8	62 2.441	13 0.512	80 3.150	6.2 0.244

Basic load ratings		Mass kg lb
N lbf		
dynamic <i>C</i> _r	static <i>C</i> _{or}	
14 000 3 150	7 850 1 770	0.23 0.57
19 500 4 400	11 300 2 540	0.36 0.86 0.78
25 700 5 750	15 300 3 450	0.55 1.30
29 100 6 550	17 800 4 000	0.74 1.77 1.63
32 500 7 350	20 400 4 600	0.80 2.01 1.93 1.76
35 000 7 900	23 200 5 200	0.94 2.38 2.28 2.18
43 500 9 750	29 200 6 550	1.22 2.96 2.84 2.70
52 500 11 800	36 000 8 150	1.54 3.60

Notes ⁽¹⁾ These numbers indicate relubricatable type. If maintenance free type is needed, please order without suffix "D1".

⁽²⁾ Adapter number with suffix "X" means a narrow slot type adapter sleeve.

In this case the lock washer with the straight inner prong should be used.

⁽³⁾ For HE2311XY, screw thread pitch different from the standard is applied, because of the thin thread section of sleeve.

To distinguish it, a suffix "Y" is added.

Ball bearings Adapter type

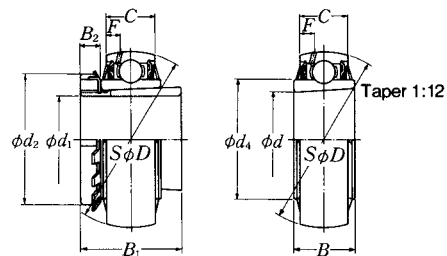

UK2...D1;H, HA, HE, HS

UK2...D1

Shaft dia. mm inch	Bearing ⁽¹⁾⁽²⁾ number	Nominal dimensions									
		mm inch									
		<i>d</i>	<i>D</i>	<i>B</i>	<i>C</i>	<i>d</i> ₄	<i>d</i> ₁	<i>B</i> ₁	<i>B</i> ₂	<i>d</i> ₂	<i>F</i>
60 2 3/16 2 1/4 2 3/8	UK213D1;H2313X UK213D1;HA2313 UK213D1;HE2313X UK213D1;HS2313X	65 2.5591	120 4.7244	40 1.5748	32 1.2598	82.5 3.248	60 2 3/16 2 1/4 2 3/8	65 2.559	14 0.551	85 3.346	8.7 0.343
65 2 7/16 2 1/2	UK215D1;H2315X UK215D1;HA2315 UK215D1;HE2315X	75 2.9528	130 5.1181	44 1.7323	34 1.3386	93 3.661	65 2 7/16 2 1/2	73 2.874	15 0.591	98 3.858	9.0 0.354
70 2 11/16 2 3/4	UK216D1;H2316X UK216D1;HA2316 UK216D1;HE2316X	80 3.1496	140 5.5118	45 1.7717	35 1.3780	98.1 3.862	70 2 11/16 2 3/4	78 3.071	17 0.669	105 4.134	9.5 0.374
75 2 15/16 3	UK217D1;H2317X UK217D1;HA2317X UK217D1;HE2317X	85 3.3465	150 5.9055	46 1.8110	36 1.4173	106.4 4.189	75 2 15/16 3	82 3.228	18 0.709	110 4.331	10.1 0.398
80 3 3/16	UK218D1;H2318X UK218D1;HA2318X	90 3.5433	160 6.2992	47 1.8504	37 1.4567	111.6 4.394	80 3 3/16	86 3.386	18 0.709	120 4.724	9.8 0.386

Notes ⁽¹⁾ These numbers indicate relubricatable type. If maintenance free type is needed, please order without suffix "D1".

⁽²⁾ Adapter number with suffix "X" means a narrow slot type adapter sleeve.
In this case the lock washer with the straight inner prong should be used.

Basic load ratings		Mass kg lb
N lbf		
dynamic <i>C</i> _r	static <i>C</i> _{or}	
57 500	40 000	2.00 4.86
12 900	9 000	4.70 4.38
66 000	49 500	2.56 6.04
14 900	11 100	5.84
72 500	53 000	3.23 7.38
16 300	11 900	7.14
83 500	64 000	3.93 8.73
18 700	14 300	8.46
96 000	71 500	4.51 11.0
21 600	16 100	

Ball bearings Adapter type

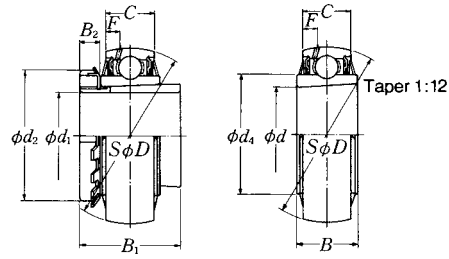

UK3...D1;H, HA, HE, HS

UK3...D1

Shaft dia. mm inch	Bearing ⁽¹⁾ (²)(³) number	Nominal dimensions									
		mm inch									
		<i>d</i>	<i>D</i>	<i>B</i>	<i>C</i>	<i>d</i> ₄	<i>d</i> ₁	<i>B</i> ₁	<i>B</i> ₂	<i>d</i> ₂	<i>F</i>
20 3/4	UK305D1;H2305X UK305D1;HE2305	25 0.9843	62 2.4409	26 1.0236	20 0.7874	36.8 1.449	20 3/4	35 1.378	8 0.315	38 1.496	5.0 0.197
25 7/8 1	UK306D1;H2306X UK306D1;HS2306 UK306D1;HE2306X	30 1.1811	72 2.8346	29 1.1417	23 0.9055	44.9 1.768	25 7/8 1	38 1.496	8 0.315	45 1.772	5.9 0.232
30 1 1/8	UK307D1;H2307X UK307D1;HS2307	35 1.3780	80 3.1496	33 1.2992	25 0.9843	49.4 1.945	30 1 1/8	43 1.693	9 0.354	52 2.047	6.8 0.268
35 1 1/4 1 3/8	UK308D1;H2308X UK308D1;HE2308X UK308D1;HS2308X	40 1.5748	90 3.5433	34 1.3386	27 1.0630	56 2.205	35 1 1/4 1 3/8	46 1.811	10 0.394	58 2.283	7.4 0.291
40 1 7/16 1 1/2 1 5/8	UK309D1;H2309X UK309D1;HA2309 UK309D1;HE2309X UK309D1;HS2309X	45 1.7717	100 3.9370	37 1.4567	29 1.1417	63.5 2.500	40 1 7/16 1 1/2 1 5/8	50 1.969	11 0.433	65 2.559	7.4 0.291
45 1 5/8 1 11/16 1 3/4	UK310D1;H2310X UK310D1;HS2310 UK310D1;HA2310 UK310D1;HE2310X	50 1.9685	110 4.3307	41 1.6142	32 1.2598	70.6 2.780	45 1 5/8 1 11/16 1 3/4	55 2.165	12 0.472	70 2.756	8.1 0.319
50 1 7/8 1 15/16 2	UK311D1;H2311X UK311D1;HS2311 UK311D1;HA2311 UK311D1;HE2311XY	55 2.1654	120 4.7244	44 1.7323	34 1.3386	76.6 3.016	50 1 7/8 1 15/16 2	59 2.323	12 0.472	75 2.953	8.5 0.335
55 2 1/8	UK312D1;H2312X UK312D1;HS2312	60 2.3622	130 5.1181	47 1.8504	36 1.4173	82.7 3.256	55 2 1/8	62 2.441	13 0.512	80 3.150	9.0 0.354

Basic load ratings		Mass kg lb
N lbf		
dynamic <i>C</i> _r	static <i>C</i> _{or}	
21 200 4 750	10 900 2 460	0.36 0.81
26 700 6 000	15 000 3 400	0.59 1.37 1.29
33 500 7 500	19 100 4 300	0.75 1.70
40 500 9 150	24 000 5 400	1.00 2.38 2.25
53 000 11 900	32 000 7 200	1.28 3.22 3.14 2.97
62 000 13 900	38 500 8 600	1.72 3.95 3.85 3.74
71 500 16 100	45 000 10 100	2.06 4.73 4.60 4.46
82 000 18 400	52 000 11 700	2.58 5.67

Notes ⁽¹⁾ These numbers indicate relubricatable type. If maintenance free type is needed, please order without suffix "D1".

⁽²⁾ Adapter number with suffix "X" means a narrow slot type adapter sleeve.

In this case the lock washer with the straight inner prong should be used.

⁽³⁾ For HE2311XY, screw thread pitch different from the standard is applied, because of the thin thread section of sleeve. To distinguish it, a suffix "Y" is added.

Ball bearings Adapter type

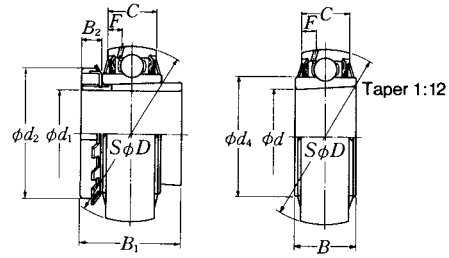

UK3...D1;H, HA, HE, HS

UK3...D1

Shaft dia. mm inch	Bearing ⁽¹⁾⁽²⁾ number	Nominal dimensions									
		mm inch									
		<i>d</i>	<i>D</i>	<i>B</i>	<i>C</i>	<i>d</i> ₄	<i>d</i> ₁	<i>B</i> ₁	<i>B</i> ₂	<i>d</i> ₂	<i>F</i>
60 2 3/16 2 1/4 2 3/8	UK313D1;H2313X UK313D1;HA2313 UK313D1;HE2313X UK313D1;HS2313X	65 2.5591	140 5.5118	49 1.9291	39 1.5354	88.2 3.472	60 2 3/16 2 1/4 2 3/8	65 2.559	14 0.551	85 3.346	10.1 0.398
65 2 7/16 2 1/2	UK315D1;H2315X UK315D1;HA2315 UK315D1;HE2315X	75 2.9528	160 6.2992	55 2.1654	43 1.6929	101.3 3.988	65 2 7/16 2 1/2	73 2.874	15 0.591	98 3.858	11.0 0.433
70 2 11/16 2 3/4	UK316D1;H2316X UK316D1;HA2316 UK316D1;HE2316X	80 3.1496	170 6.6929	58 2.2835	45 1.7717	107.9 4.248	70 2 11/16 2 3/4	78 3.071	17 0.669	105 4.134	11.4 0.449
75 2 15/16 3	UK317D1;H2317X UK317D1;HA2317X UK317D1;HE2317X	85 3.3465	180 7.0866	60 2.3622	47 1.8504	114.4 4.504	75 2 15/16 3	82 3.228	18 0.709	110 4.331	12.0 0.472
80 3 3/16	UK318D1;H2318X UK318D1;HA2318X	90 3.5433	190 7.4803	64 2.5197	49 1.9291	120.9 4.760	80 3 3/16	86 3.386	18 0.709	120 4.724	12.3 0.484
85 3 1/4	UK319D1;H2319X UK319D1;HE2319X	95 3.7402	200 7.8740	67 2.6378	51 2.0079	127.5 5.020	85 3 1/4	90 3.543	19 0.748	125 4.921	12.8 0.504
90 3 7/16 3 1/2	UK320D1;H2320X UK320D1;HA2320 UK320D1;HE2320X	100 3.9370	215 8.4646	73 2.8740	55 2.1654	135.6 5.339	90 3 7/16 3 1/2	97 3.819	20 0.787	130 5.118	13.5 0.531
100	UK322D1;H2322X	110	240	80	59	151.7	100	105	21	145	13.9
110	UK324D1;H2324	120	260	86	63	165.2	110	112	22	155	16.0
115	UK326D1;H2326	130	280	90	67	178.3	115	121	23	165	16.9
125	UK328D1;H2328	140	300	95	71	190.4	125	131	24	180	17.7

Notes ⁽¹⁾ These numbers indicate relubricatable type. If maintenance free type is needed, please order without suffix "D1".

⁽²⁾ Adapter number with suffix "X" means a narrow slot type adapter sleeve.
In this case the lock washer with the straight inner prong should be used.

Basic load ratings		Mass kg lb
N lbf dynamic <i>C</i> _r	static <i>C</i> _{or}	
92 500 20 800	60 000 13 400	3.08 7.24 7.08 6.76
113 000 25 500	77 000 17 400	4.75 11.1 10.9
123 000 27 600	86 500 19 500	5.75 12.9 12.7
133 000 29 800	97 000 21 800	6.72 14.9 14.6
143 000 32 000	107 000 24 100	7.75 17.2
153 000 34 500	119 000 26 600	9.02 20.4
173 000 39 000	141 000 31 500	11.0 24.7 25.1
205 000 207 000	179 000 185 000	14.9 18.0
229 000	214 000	23.3
253 000	246 000	28.6

Ball bearings Adapter type

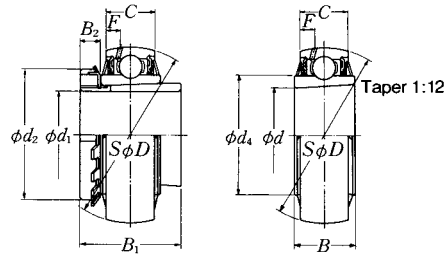

UKX...D1;H, HA, HE, HS

UKX...D1

Shaft dia. mm inch	Bearing ⁽¹⁾ (²)(³) number	Nominal dimensions									
		mm inch									
		<i>d</i>	<i>D</i>	<i>B</i>	<i>C</i>	<i>d</i> ₄	<i>d</i> ₁	<i>B</i> ₁	<i>B</i> ₂	<i>d</i> ₂	<i>F</i>
20 3/4	UKX05D1;H2305X UKX05D1;HE2305	25 0.9843	62 2.4409	26 1.0236	19 0.7480	40.8 1.606	20 3/4	35 1.378	8 0.315	38 1.496	4.6 0.181
25 7/8 1	UKX06D1;H2306X UKX06D1;HS2306 UKX06D1;HE2306X	30 1.1811	72 2.8346	29 1.1417	20 0.7874	46.8 1.843	25 7/8 1	38 1.496	8 0.315	45 1.772	4.6 0.181
30 1 1/8	UKX07D1;H2307X UKX07D1;HS2307	35 1.3780	80 3.1496	31 1.2205	21 0.8268	53 2.087	30 1 1/8	43 1.693	9 0.354	52 2.047	4.5 0.177
35 1 1/4 1 3/8	UKX08D1;H2308X UKX08D1;HE2308X UKX08D1;HS2308X	40 1.5748	85 3.3465	31 1.2205	22 0.8661	57.5 2.264	35 1 1/4 1 3/8	46 1.811	10 0.394	58 2.283	4.9 0.193
40 1 7/16 1 1/2 1 5/8	UKX09D1;H2309X UKX09D1;HA2309 UKX09D1;HE2309X UKX09D1;HS2309X	45 1.7717	90 3.5433	32 1.2598	24 0.9449	62.4 2.457	40 1 7/16 1 1/2 1 5/8	50 1.969	11 0.433	65 2.559	5.9 0.232
45 1 5/8 1 11/16 1 3/4	UKX10D1;H2310X UKX10D1;HS2310 UKX10D1;HA2310 UKX10D1;HE2310X	50 1.9685	100 3.9370	35 1.3780	25 0.9843	69 2.717	45 1 5/8 1 11/16 1 3/4	55 2.165	12 0.472	70 2.756	6.0 0.236
50 1 7/8 1 15/16 2	UKX11D1;H2311X UKX11D1;HS2311 UKX11D1;HA2311 UKX11D1;HE2311XY	55 2.1654	110 4.3307	38 1.4961	27 1.0630	77 3.031	50 1 7/8 1 15/16 2	59 2.323	12 0.472	75 2.953	6.2 0.244
55 2 1/8	UKX12D1;H2312X UKX12D1;HS2312	60 2.3622	120 4.7244	40 1.5748	32 1.2598	82.5 3.248	55 2 1/8	62 2.441	13 0.512	80 3.150	8.7 0.343

Basic load ratings	dynamic <i>C</i> _r	static <i>C</i> _{0r}	Mass kg lb		
				N lbf	
19 500	11 300	0.38			
4 400	2 540	0.85			
25 700	15 300	0.53			
5 750	3 450	1.24			
		1.16			
29 100	17 800	0.75			
6 550	4 000	1.70			
32 500	20 400	0.85			
7 350	4 600	2.01			
		1.88			
35 000	23 200	0.97			
		2.32			
7 900	5 200	2.24			
		2.07			
43 500	29 200	1.26			
		3.09			
9 750	6 550	2.99			
		2.88			
52 500	36 000	1.62			
		3.84			
11 800	8 150	3.72			
		3.58			
57 500	40 000	2.07			
12 900	9 000	4.66			

Notes ⁽¹⁾ These numbers indicate relubricatable type. If maintenance free type is needed, please order without suffix "D1".

⁽²⁾ Adapter number with suffix "X" means a narrow slot type adapter sleeve.

In this case the lock washer with the straight inner prong should be used.

⁽³⁾ For HE2311XY, screw thread pitch different from the standard is applied, because of the thin thread section of sleeve. To distinguish it, a suffix "Y" is added.

Ball bearings Adapter type

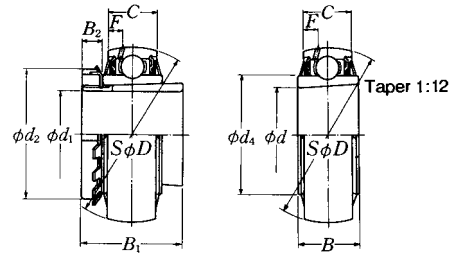

UKX...D1;H, HA, HE, HS

UKX...D1

Shaft dia. mm inch	Bearing ⁽¹⁾⁽²⁾ number	Nominal dimensions									
		mm inch									
		<i>d</i>	<i>D</i>	<i>B</i>	<i>C</i>	<i>d</i> ₄	<i>d</i> ₁	<i>B</i> ₁	<i>B</i> ₂	<i>d</i> ₂	<i>F</i>
60 2 3/16 2 1/4 2 3/8	UKX13D1;H2313X UKX13D1;HA2313 UKX13D1;HE2313X UKX13D1;HS2313X	65 2.5591	125 4.9213	42 1.6535	33 1.2992	87 3.425	60 2 3/16 2 1/4 2 3/8	65 2.559	14 0.551	85 3.346	8.8 0.346
65 2 7/16 2 1/2	UKX15D1;H2315X UKX15D1;HA2315 UKX15D1;HE2315X	75 2.9528	140 5.5118	45 1.7717	35 1.3780	98.1 3.862	65 2 7/16 2 1/2	73 2.874	15 0.591	98 3.858	9.5 0.374
70 2 11/16 2 3/4	UKX16D1;H2316X UKX16D1;HA2316 UKX16D1;HE2316X	80 3.1496	150 5.9055	46 1.8110	36 1.4173	106.4 4.189	70 2 11/16 2 3/4	78 3.071	17 0.669	105 4.134	10.1 0.398
75 2 15/16 3	UKX17D1;H2317X UKX17D1;HA2317X UKX17D1;HE2317X	85 3.3465	160 6.2992	47 1.8504	37 1.4567	111.6 4.394	75 2 15/16 3	82 3.228	18 0.709	110 4.331	9.8 0.386
80 3 3/16	UKX18D1;H2318X UKX18D1;HA2318X	90 3.5433	170 6.6929	49 1.9291	39 1.5354	118.2 4.654	80 3 3/16	86 3.386	18 0.709	120 4.724	10.5 0.413
90	UKX20D1;H2320X	100	190	57	44	131.3	90	97	20	130	11.3

Notes ⁽¹⁾ These numbers indicate relubricatable type. If maintenance free type is needed, please order without suffix "D1".

⁽²⁾ Adapter number with suffix "X" means a narrow slot type adapter sleeve.
In this case the lock washer with the straight inner prong should be used.

Basic load ratings		Mass kg lb
N lbf dynamic <i>C</i> _r	static <i>C</i> _{or}	
62 000	44 000	2.19 5.28
14 000	9 900	5.12 4.79
72 500	53 000	3.25 7.47
16 300	11 900	7.27
83 500	64 000	3.87 8.79
18 700	14 300	8.56
96 000	71 500	4.53 10.6
21 600	16 100	10.3
109 000	82 000	5.17
24 500	18 400	11.2
133 000	105 000	7.39

Ball bearings Set screw type

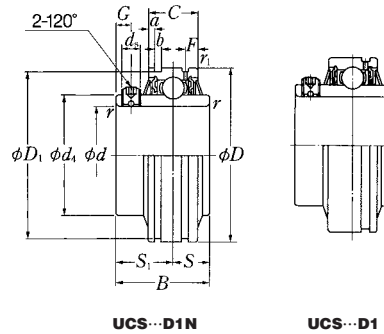

Shaft dia. mm inch	Bearing (1) number	Nominal dimensions									
		d	D	B	C	mm inch		S	S ₁	G	d _s
						r	r ₁				
12	UCS201LD1N	12	47	31	17	0.6	0.6	12.7	18.3	4.5	M5×0.8
1/2	UCS201-008LD1N	0.5000	1.8504	1.2205	0.6693	0.024	0.024	0.500	0.720	0.177	No.10-32UNNF
15	UCS202LD1N	15	47	31	17	0.6	0.6	12.7	18.3	4.5	M5×0.8
9/16	UCS202-009LD1N	0.5625	1.8504	1.2205	0.6693	0.024	0.024	0.500	0.720	0.177	No.10-32UNNF
5/8	UCS202-010LD1N	0.6250	1.8504	1.2205	0.6693	0.024	0.024	0.500	0.720	0.177	No.10-32UNNF
17	UCS203LD1N	17	47	31	17	0.6	0.6	12.7	18.3	4.5	M5×0.8
11/16	UCS203-011LD1N	0.6875	1.8504	1.2205	0.6693	0.024	0.024	0.500	0.720	0.177	No.10-32UNNF
20	UCS204LD1N	20	47	31	17	1	0.6	12.7	18.3	4.5	M5×0.8
3/4	UCS204-012LD1N	0.7500	1.8504	1.2205	0.6693	0.039	0.024	0.500	0.720	0.177	No.10-32UNNF
25	UCS205LD1N	25	52	34.1	17	1	0.6	14.3	19.8	5	M5×0.8
13/16	UCS205-013LD1N	0.8125									
7/8	UCS205-014LD1N	0.8750									
15/16	UCS205-015LD1N	0.9375	2.0472	1.3425	0.6693	0.039	0.024	0.563	0.780	0.197	No.10-32UNNF
1	UCS205-100LD1N	1.0000									
30	UCS206LD1N	30	62	38.1	19	1	1	15.9	22.2	5	M6×0.75
1 1/16	UCS206-101LD1N	1.0625									
1 1/8	UCS206-102LD1N	1.1250	2.4409	1.5000	0.7480	0.039	0.039	0.626	0.874	0.197	1/4-28UNF
1 3/16	UCS206-103LD1N	1.1875	2.4409	1.5000	0.7480	0.039	0.039	0.626	0.874	0.197	1/4-28UNF
1 1/4	UCS206-104LD1N	1.2500	2.4409	1.5000	0.7480	0.039	0.039	0.626	0.874	0.197	1/4-28UNF
35	UCS207LD1N	35	72	42.9	20	1.5	1.5	17.5	25.4	6	M6×0.75
1 1/4	UCS207-104LD1N	1.2500									
1 5/16	UCS207-105LD1N	1.3125									
1 3/8	UCS207-106LD1N	1.3750	2.8346	1.6890	0.7874	0.059	0.059	0.689	1.000	0.236	1/4-28UNF
1 7/16	UCS207-107LD1N	1.4375	2.8346	1.6890	0.7874	0.059	0.059	0.689	1.000	0.236	1/4-28UNF
40	UCS208LD1N	40	80	49.2	21	1.5	1.5	19	30.2	8	M8×1
1 1/2	UCS208-108LD1N	1.5000	3.1496	1.9370	0.8268	0.059	0.059	0.748	1.189	0.315	5/16-24UNF
1 9/16	UCS208-109LD1N	1.5625	3.1496	1.9370	0.8268	0.059	0.059	0.748	1.189	0.315	5/16-24UNF
45	UCS209LD1N	45	85	49.2	22	1.5	1.5	19	30.2	8	M8×1
1 5/8	UCS209-110LD1N	1.6250									
1 11/16	UCS209-111LD1N	1.6875	3.3465	1.9370	0.8661	0.059	0.059	0.748	1.189	0.315	5/16-24UNF
1 3/4	UCS209-112LD1N	1.7500	3.3465	1.9370	0.8661	0.059	0.059	0.748	1.189	0.315	5/16-24UNF

Note (1) These numbers indicate relubricatable type. If maintenance free type is needed, please order without suffix "D1".

Nominal dimensions					Basic load ratings		Mass
d ₄	D ₁	mm inch		F	N lbf		kg lb
		a	b		dynamic C _r	static C _{or}	
29.6	44.6	3.1	1.5	4	12 800	6 650	0.21
1.1654	1.756	0.122	0.059	0.157	2 890	1 500	0.46
29.6	44.6	3.1	1.5	4	12 800	6 650	0.20
1.1654	1.756	0.122	0.059	0.157	2 890	1 500	0.44
29.6	44.6	3.1	1.5	4	12 800	6 650	0.18
1.1654	1.756	0.122	0.059	0.157	2 890	1 500	0.39
29.6	44.6	3.1	1.5	4	12 800	6 650	0.17
1.1654	1.756	0.122	0.059	0.157	2 890	1 500	0.39
33.9	49.73	3.2	1.5	4.1	14 000	7 850	0.20
							0.53
1.3346	1.958	0.126	0.059	0.161	3 150	1 770	0.51
							0.46
40.8	59.61	3.2	2.05	4.2	19 500	11 300	0.34
							0.82
1.6063	2.347	0.126	0.081	0.165	4 400	2 540	0.77
							0.73
46.8	68.81	3.3	2.05	5	25 700	15 300	0.48
							1.21
1.8425	2.709	0.130	0.081	0.197	5 750	3 450	1.15
							1.08
53	76.81	3.4	2.05	5	29 100	17 800	0.65
							1.52
2.0866	3.024	0.134	0.081	0.197	6 550	4 000	1.46
							1.46
57.5	81.81	3.5	2.05	5.1	32 500	20 400	0.70
							1.76
2.2638	3.221	0.138	0.081	0.201	7 350	4 600	1.68
							1.57

Ball bearings Set screw type

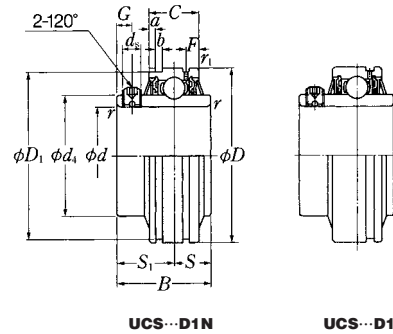

Shaft dia. mm inch	Bearing (1) number	Nominal dimensions									
		<i>d</i>	<i>D</i>	<i>B</i>	<i>C</i>	mm inch		<i>S</i>	<i>S</i> ₁	<i>G</i>	<i>d</i> _s
						<i>r</i> min.	<i>r</i> ₁ min.				
50	UCS210LD1N	50	90	51.6	24	1.5	1.5	19	32.6	9	M8x1
1 ¹³ / ₁₆	UCS210-113LD1N	1.8125									
1 ⁷ / ₈	UCS210-114LD1N	1.8750									
1 ¹⁵ / ₁₆	UCS210-115LD1N	1.9375	3.5433	2.0315	0.9449	0.059	0.059	0.748	1.283	0.354	5/16"-24UNF
2	UCS210-200LD1N	2.0000									
55	UCS211LD1N	55	100	55.6	25	2	2	22.2	33.4	9	M8x1
2	UCS211-200LD1N	2.0000									
2 ¹ / ₁₆	UCS211-201LD1N	2.0625									
2 ¹ / ₈	UCS211-202LD1N	2.1250	3.9370	2.1890	0.9843	0.079	0.079	0.874	1.315	0.354	5/16"-24UNF
2 ³ / ₁₆	UCS211-203LD1N	2.1875									
60	UCS212LD1N	60	110	65.1	27	2	2	25.4	39.7	10	M10x1.25
2 ¹ / ₄	UCS212-204LD1N	2.2500									
2 ⁵ / ₁₆	UCS212-205LD1N	2.3125									
2 ³ / ₈	UCS212-206LD1N	2.3750	4.3307	2.5630	1.0630	0.079	0.079	1.000	1.563	0.394	3/8"-24UNF
2 ⁷ / ₁₆	UCS212-207LD1N	2.4375									
65	UCS213D1	65	120	65.1	32	2	2	25.4	39.7	10	M10x1.25
2 ¹ / ₂	UCS213-208D1	2.5000									
2 ⁹ / ₁₆	UCS213-209D1	2.5625	4.7244	2.5630	1.2598	0.079	0.079	1.000	1.563	0.394	3/8"-24UNF
70	UCS214D1	70	125	74.6	33	2	2	30.2	44.4	12	M10x1.25
75	UCS215D1	75	130	77.8	34	2	2	33.3	44.5	12	M10x1.25
80	UCS216D1	80	140	82.6	35	2.5	2.5	33.3	49.3	12	M10x1.25
85	UCS217D1	85	150	85.7	36	2.5	2.5	34.1	51.6	12	M12x1.5
90	UCS218D1	90	160	96	37	2.5	2.5	39.7	56.3	12	M12x1.5

Note (1) These numbers indicate relubricatable type. If maintenance free type is needed, please order without suffix "D1".

Nominal dimensions					Basic load ratings		Mass
<i>d</i> ₄	<i>D</i> ₁	mm inch		<i>F</i>	N lbf		kg lb
		<i>a</i>	<i>b</i>		dynamic <i>C</i> _r	static <i>C</i> _{or}	
62.4	86.79	3.7	2.85	5.6	35 000	23 200	0.78 2.03
2.4567	3.417	0.146	0.112	0.220	7 900	5 200	1.92 1.81 1.69
69	96.80	4.4	2.85	5.9	43 500	29 200	1.06 2.71
2.7165	3.811	0.173	0.112	0.232	9 750	6 550	2.60 2.46 2.34
77	106.81	4.4	2.85	6	52 500	36 000	1.48 3.78
3.0315	4.205	0.173	0.112	0.236	11 800	8 150	3.62 3.45 3.29
82.5	—	—	—	6.8	57 500	40 000	1.88 4.41
3.2480	—	—	—	0.268	12 900	9 000	4.24
87	—	—	—	7	62 000	44 000	2.17
93	—	—	—	7	66 000	49 500	2.43
98.1	—	—	—	7.5	72 500	53 000	2.89
106.4	—	—	—	7.5	83 500	64 000	3.47
111.6	—	—	—	7	96 000	71 500	4.24

Ball bearings Set screw type

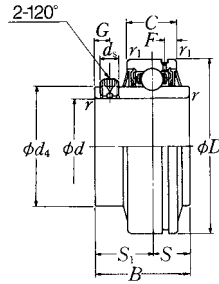

Shaft dia. mm inch	Bearing (1) number	Nominal dimensions									
		<i>d</i>	<i>D</i>	<i>B</i>	<i>C</i>	<i>r</i> mm min.	<i>r</i> ₁ inch min.	<i>S</i>	<i>S</i> ₁	<i>G</i>	<i>d</i> _s
25 1 3/16	UCS305D1	25	62	38	20	1.5	0.6	15	23	6	M6×0.75
	UCS305-013D1	0.8125									
	UCS305-014D1	0.8750	2.4409	1.4961	0.7874	0.059	0.024	0.591	0.906	0.236	1/4-28UNF
	UCS305-015D1	0.9375									
1	UCS305-100D1	1.0000									
30 1 1/16	UCS306D1	30	72	43	23	1.5	1	17	26	6	M6×0.75
	UCS306-101D1	1.0625									
	UCS306-102D1	1.1250	2.8346	1.6929	0.9055	0.059	0.039	0.669	1.024	0.236	1/4-28UNF
	UCS306-103D1	1.1875									
35 1 1/4	UCS307D1	35	80	48	25	2	1	19	29	8	M8×1
	UCS307-104D1	1.2500									
	UCS307-105D1	1.3125	3.1496	1.8898	0.9843	0.079	0.039	0.748	1.142	0.315	5/16-24UNF
	UCS307-106D1	1.3750									
	UCS307-107D1	1.4375									
40 1 1/2	UCS308D1	40	90	52	27	2	1	19	33	10	M10×1.25
	UCS308-108D1	1.5000	3.5433	2.0472	1.0630	0.079	0.039	0.748	1.299	0.394	3/8-24UNF
	UCS308-109D1	1.5625									
45 1 5/8	UCS309D1	45	100	57	29	2	1	22	35	10	M10×1.25
	UCS309-110D1	1.6250									
	UCS309-111D1	1.6875	3.9370	2.2441	1.1417	0.079	0.039	0.866	1.378	0.394	3/8-24UNF
	UCS309-112D1	1.7500									
50 1 13/16	UCS310D1	50	110	61	32	2.5	1.5	22	39	12	M12×1.5
	UCS310-113D1	1.8125									
	UCS310-114D1	1.8750	4.3307	2.4016	1.2598	0.098	0.059	0.866	1.535	0.472	1/2-20UNF
	UCS310-115D1	1.9375									
55 2	UCS311D1	55	120	66	34	2.5	1.5	25	41	12	M12×1.5
	UCS311-200D1	2.0000									
	UCS311-201D1	2.0625	4.7244	2.5984	1.3386	0.098	0.059	0.984	1.614	0.472	1/2-20UNF
	UCS311-202D1	2.1250									
	UCS311-203D1	2.1875									

Note (1) These numbers indicate relubricatable type. If maintenance free type is needed, please order without suffix "D1".

Nominal dimensions mm inch		Basic load ratings N lbf		Mass kg lb
<i>d</i> ₄	<i>F</i>	dynamic <i>C</i> _r	static <i>C</i> _{or}	
36.8	4.3	21 200	10 900	0.37 0.94
1.4488	0.169	4 750	2 460	0.90 0.83
				0.81
44.9	5.1	26 700	15 000	0.58 1.39
1.7677	0.201	6 000	3 400	1.33 1.28
49.4	5.3	33 500	19 100	0.74 1.77
1.9449	0.209	7 500	4 300	1.70 1.64
				1.57
56	5.6	40 500	24 000	1.00 2.32
2.2047	0.220	9 150	5 400	2.23 3.17
63.5	5.8	53 000	32 000	1.33 3.09
2.5000	0.228	11 900	7 200	2.98 3.85
70.6	6.3	62 000	38 500	1.72 4.10
2.7795	0.248	13 900	8 600	3.99 3.85
76.6	6.5	71 500	45 000	2.15 5.14
3.0157	0.256	16 100	10 100	4.99 4.85
				4.68

Ball bearings Set screw type

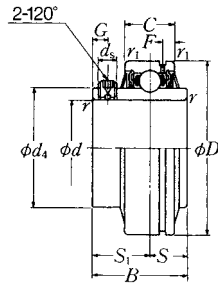

Shaft dia. mm inch	Bearing (1) number	Nominal dimensions									
		d	D	B	C	mm inch		S	S ₁	G	d _s
						r min.	r ₁ min.				
60 2 1/4 2 9/16 2 3/8 2 7/16	UCS312D1 UCS312-204D1 UCS312-205D1 UCS312-206D1 UCS312-207D1	60 2.2500 2.3125 2.3750 2.4375	130	71	36	2.5	1.5	26	45	12	M12×1.5
65 2 1/2 2 9/16	UCS313D1 UCS313-208D1 UCS313-209D1	65 2.5000 2.5625	140	75	39	2.5	2	30	45	12	M12×1.5
70 2 5/8 2 1/2 2 3/4	UCS314D1 UCS314-210D1 UCS314-211D1 UCS314-212D1	70 2.6250 2.6875 2.7500	150	78	41	2.5	2	33	45	12	M12×1.5
75 2 3/4 2 13/16 2 7/8 2 5/8 3	UCS315D1 UCS315-213D1 UCS315-214D1 UCS315-215D1 UCS315-300D1	75 2.8125 2.8750 2.9375 3.0000	160	82	43	2.5	2	32	50	14	M14×1.5
80 3 1/16 3 1/8 3 3/16	UCS316D1 UCS316-301D1 UCS316-302D1 UCS316-303D1	80 3.0625 3.1250 3.1875	170	86	45	2.5	2	34	52	14	M14×1.5
85 3 1/4 3 5/16 3 7/16	UCS317D1 UCS317-304D1 UCS317-305D1 UCS317-307D1	85 3.2500 3.3125 3.4375	180	96	47	3	2.5	40	56	16	M16×1.5
90 3 7/16 3 1/2	UCS318D1 UCS318-307D1 UCS318-308D1	90 3.4375 3.5000	190	96	49	3	2.5	40	56	16	M16×1.5

Note (1) These numbers indicate relubricatable type. If maintenance free type is needed, please order without suffix "D1".

Nominal dimensions mm inch		Basic load ratings N lbf		Mass kg lb
d ₄	F	dynamic C _r	static C _{or}	
82.7	6.7	82 000	52 000	2.70 6.27
3.2559	0.264	18 400	11 700	6.10 5.89 5.72
88.2	7.5	92 500	60 000	3.37 7.63
3.4724	0.295	20 800	13 400	7.41
94.8	7.5	104 000	68 000	4.03 9.37
3.7323	0.295	23 400	15 300	9.13 8.91
101.3	7.7	113 000	77 000	4.88 11.4
3.9882	0.303	25 500	17 400	11.1 10.9 10.6
107.9	7.8	123 000	86 500	5.74 13.0
4.2480	0.307	27 600	19 500	12.7 12.5
114.4	8.2	133 000	97 000	6.88 15.7
4.5039	0.323	29 800	21 800	15.4 14.7
120.9	8.5	143 000	107 000	7.80 17.8
4.7598	0.335	32 000	24 100	17.4

Ball bearings Set screw type

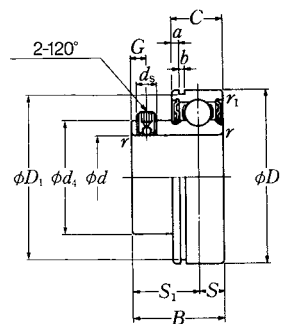

Shaft dia. mm inch	Bearing number	Nominal dimensions											
		d	D	B	C	mm		inch		S ₁	G	d _s	d ₄
						r	r ₁	S	S				
12 1/2	ASS201N ASS201-008N	12 0.5000	40 1.5748	22 0.8661	12 0.4724	0.6 0.024	0.6 0.024	6 0.236	16 0.630	4.2 0.165	M5×0.8 No.10-32UNF	24.3 0.957	
15 9/16 5/8	ASS202N ASS202-009N ASS202-010N	15 0.5625 0.6250	40 1.5748	22 0.8661	12 0.4724	0.6 0.024	0.6 0.024	6 0.236	16 0.630	4.2 0.165	M5×0.8 No.10-32UNF	24.3 0.957	
17 11/16	ASS203N ASS203-011N	17 0.6875	40 1.5748	22 0.8661	12 0.4724	0.6 0.024	0.6 0.024	6 0.236	16 0.630	4.2 0.165	M5×0.8 No.10-32UNF	24.3 0.957	
20 3/4	ASS204N ASS204-012N	20 0.7500	47 1.8504	25 0.9843	14 0.5512	1 0.039	0.6 0.024	7 0.276	18 0.709	4.2 0.165	M5×0.8 No.10-32UNF	29.6 1.165	
25 13/16 7/8 15/16 1	ASS205N ASS205-013N ASS205-014N ASS205-015N ASS205-100N	25 0.8125 0.8750 0.9375 1.0000	52 2.0472	27 1.0630	15 0.5906	1 0.039	0.6 0.024	7.5 0.295	19.5 0.768	5 0.197	M5×0.8 No.10-32UNF	33.9 1.335	
30 1 1/16 1 1/8 1 3/16 1 1/4	ASS206N ASS206-101N ASS206-102N ASS206-103N ASS206-104N	30 1.0625 1.1250 1.1875 1.2500	62 2.4409	29 1.1417	16 0.6299	1 0.039	0.6 0.024	8 0.315	21 0.827	5 0.197	M6×0.75 1/4-28UNF	40.8 1.606	
35 1 1/4 1 5/16 1 3/8 1 7/16	ASS207N ASS207-104N ASS207-105N ASS207-106N ASS207-107N	35 1.2500 1.3125 1.3750 1.4375	72 2.8346	34 1.3386	17 0.6693	1.5 0.059	0.6 0.024	8.5 0.335	25.5 1.004	6 0.236	M6×0.75 1/4-28UNF	46.8 1.843	
40 1 1/2 1 9/16	ASS208N ASS208-108N ASS208-109N	40 1.5000 1.5625	80 3.1496	38 1.4961	18 0.7087	1.5 0.059	0.6 0.024	9 0.354	29 1.142	8 0.315	M8×1 5/16-24UNF	53 2.087	

Nominal dimensions			Basic load ratings		Mass
D ₁	mm inch		N lbf		kg lb
	a	b	dynamic C _r	static C _{0r}	
38.1 1.500	1.98 0.078	1.5 0.059	9 600 2 160	4 600 1 030	0.12 0.24
38.1 1.500	1.98 0.078	1.5 0.059	9 600 2 160	4 600 1 030	0.11 0.23 0.22
38.1 1.500	1.98 0.078	1.5 0.059	9 600 2 160	4 600 1 030	0.10 0.20
44.6 1.756	2.38 0.094	1.5 0.059	12 800 2 890	6 650 1 500	0.17 0.33
49.73	2.38	1.5	14 000	7 850	0.20 0.46 0.44 0.42 0.39
59.61	3.18	2.05	19 500	11 300	0.31 0.67 0.65 0.63 0.61
68.81	3.18	2.05	25 700	15 300	0.49 1.18 1.05 0.93 0.81
76.81	3.18	2.05	29 100	17 800	0.50 1.15 1.06
3.024	0.125	0.081	6 550	4 000	

Ball bearings Eccentric locking collar type

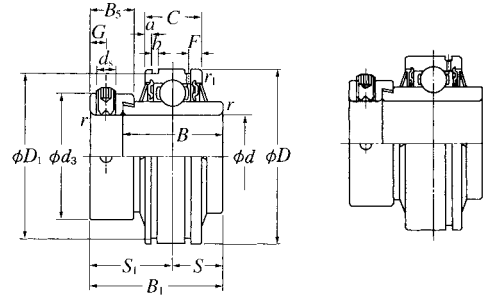

UELS...D1N

UELS...D1

Shaft dia. mm inch	Bearing (1) number	Nominal dimensions										
		d	D	B ₁	B	C		r	r ₁	S	S ₁	G
						mm	inch					
20 3/4	UELS204LD1NW3 UELS204-012LD1NW3	20 0.7500	47 1.8504	43.7 1.720	34.2 1.3465	17 0.6693	1 0.039	0.6 0.024	17.1 0.673	26.6 1.047	4.8 0.189	
25 13/16 7/8 15/16	UELS205LD1NW3 UELS205-013LD1NW3 UELS205-014LD1NW3 UELS205-015LD1NW3 UELS205-100LD1NW3	25 0.8125 0.8750 0.9375 1.0000	52 2.0472	44.4 1.748	34.9 1.3740	17 0.6693	1 0.039	0.6 0.024	17.45 0.687	26.9 1.059	4.8 0.189	
30 1 1/16 1 1/8 1 1/16 1 1/4	UELS206LD1NW3 UELS206-101LD1NW3 UELS206-102LD1NW3 UELS206-103LD1NW3 UELS206-104LD1NW3	30 1.0625 1.1250 1.1875 1.2500	62 2.4409	48.4 1.906	36.5 1.4370	19 0.7480	1 0.039	1 0.039	18.25 0.719	30.1 1.185	6 0.236	
35 1 1/4 1 1/16 1 3/8 1 7/16	UELS207LD1NW3 UELS207-104LD1NW3 UELS207-105LD1NW3 UELS207-106LD1NW3 UELS207-107LD1NW3	35 1.2500 1.3125 1.3750 1.4375	72 2.8346	51.1 2.012	37.6 1.4803	20 0.7874	1.5 0.059	1.5 0.059	18.8 0.740	32.3 1.272	6.8 0.268	
40 1 1/2 1 9/16	UELS208LD1NW3 UELS208-108LD1NW3 UELS208-109LD1NW3	40 1.5000 1.5625	80 3.1496	56.3 2.217	42.8 1.6850	21 0.8268	1.5 0.059	1.5 0.059	21.4 0.843	34.9 1.374	6.8 0.268	
45 1 5/8 1 11/16 1 3/4	UELS209LD1NW3 UELS209-110LD1NW3 UELS209-111LD1NW3 UELS209-112LD1NW3	45 1.6250 1.6875 1.7500	85 3.3465	56.3 2.217	42.8 1.6850	22 0.8661	1.5 0.059	1.5 0.059	21.4 0.843	34.9 1.374	6.8 0.268	
50 1 13/16 1 7/8 1 15/16 2	UCS210LD1NW3 UCS210-113LD1NW3 UCS210-114LD1NW3 UCS210-115LD1NW3 UCS210-200LD1NW3	50 1.8125 1.8750 1.9375 2.0000	90 3.5433	62.7 2.469	49.2 1.9370	24 0.9449	1.5 0.059	1.5 0.059	24.6 0.969	38.1 1.500	6.8 0.268	

Note (1) These numbers indicate relubricatable type. If maintenance free type is needed, please order without suffix "D1".

Nominal dimensions							Basic load ratings		Mass kg lb
d _s	d ₃	B ₅	D ₁	a	b	F	N lbf		
							dynamic C _r	static C _{or}	
M6×0.75 1/4-28UNF	33 1.299	13.5 0.531	44.6 1.756	3.1 0.122	1.5 0.059	4 0.157	12 800 2 890	6 650 1 500	0.23 0.45
M6×0.75 1/4-28UNF	38 1.496	13.5 0.531	49.73 1.958	3.2 0.126	1.5 0.059	4.1 0.161	14 000 3 150	7 850 1 770	0.27 0.61 0.58 0.55 0.51
M8×1 5/16-24UNF	44.5 1.752	15.9 0.626	59.61 2.347	3.2 0.126	2.05 0.081	4.2 0.165	19 500 4 400	11 300 2 540	0.41 0.94 0.89 0.84 0.80
M10×1.25 3/8-24UNF	55.5 2.185	17.5 0.689	68.81 2.709	3.3 0.130	2.05 0.081	5 0.197	25 700 5 750	15 300 3 450	0.60 1.45 1.40 1.35 1.28
M10×1.25 3/8-24UNF	60 2.362	18.3 0.720	76.81 3.024	3.4 0.134	2.05 0.081	5 0.197	29 100 6 550	17 800 4 000	0.79 1.90 1.82
M10×1.25 3/8-24UNF	63.5 2.500	18.3 0.720	81.81 3.221	3.5 0.138	2.05 0.081	5.1 0.201	32 500 7 350	20 400 4 600	0.85 2.05 1.97 1.88
M10×1.25 3/8-24UNF	69.5 2.736	18.3 0.720	86.79 3.417	3.7 0.146	2.85 0.112	5.6 0.220	35 000 7 900	23 200 5 200	0.98 2.46 2.36 2.25 2.09

UELS2

Ball bearings Eccentric locking collar type

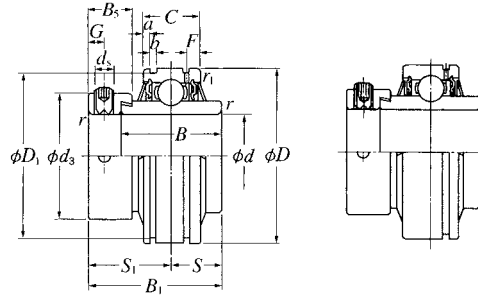

UELS...D1N

UELS...D1

Shaft dia. mm inch	Bearing ⁽¹⁾ number	Nominal dimensions										
		<i>d</i>	<i>D</i>	<i>B</i> ₁	<i>B</i>	<i>C</i>		<i>r</i>	<i>r</i> ₁	<i>S</i>	<i>S</i> ₁	<i>G</i>
						mm	inch					
55 2 2 1/16 2 1/8 2 3/16	UELS211LD1NW3 UELS211-200LD1NW3 UELS211-201LD1NW3 UELS211-202LD1NW3 UELS211-203LD1NW3	55 2.0000 2.0625 2.1250 2.1875	100 3.9370	71.4 2.811	55.5 2.1850	25 0.9843	2 0.079	2 0.079	27.75 1.093	43.6 1.717	8 0.315	
60 2 1/4 2 5/16 2 3/8 2 7/16	UELS212LD1NW3 UELS212-204LD1W3 UELS212-205LD1W3 UELS212-206LD1W3 UELS212-207LD1W3	60 2.2500 2.3125 2.3750 2.4375	110 4.3307	77.8 3.063	61.9 2.4370	27 1.0630	2 0.079	2 0.079	30.95 1.219	46.8 1.843	8 0.315	

Note ⁽¹⁾ These numbers indicate relubricatable type. If maintenance free type is needed, please order without suffix "D1".

Nominal dimensions							Basic load ratings		Mass kg lb
<i>d</i> _s	<i>d</i> ₃	mm inch		<i>a</i>	<i>b</i>	<i>F</i>	N lbf		
		<i>B</i> ₅	<i>D</i> ₁				dynamic <i>C</i> _r	static <i>C</i> _{or}	
M10×1.25	76	20.7	96.80	4.4	2.85	5.9	43 500	29 200	1.32 3.28
3/8"-24UNF	2.992	0.815	3.811	0.173	0.112	0.232	9 750	6 550	3.12 3.02 2.90
M10×1.25	84	22.3	106.81	4.4	2.85	6	52 500	36 000	1.93 4.50
3/8"-24UNF	3.307	0.878	4.205	0.173	0.112	0.236	11 800	8 150	4.34 4.17 4.00

Ball bearings Eccentric locking collar type

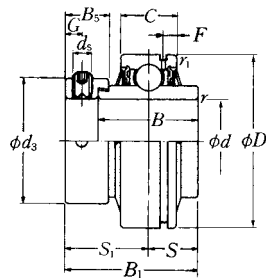

Shaft dia. mm inch	Bearing (1) number	Nominal dimensions										
		d	D	B ₁	B	C	mm		S	S ₁	G	d _s
							r	r ₁				
25	UELS305D1W3	25	62	46.8	34.9	20	1.5	0.6	16.7	30.1	6	M8×1
¹³ / ₁₆	UELS305-013D1W3	0.8125										
⁷ / ₈	UELS305-014D1W3	0.8750	2.4409	1.843	1.3740	0.7874	0.059	0.024	0.657	1.185	0.236	⁵ / ₁₆ -24UNF
¹⁵ / ₁₆	UELS305-015D1W3	0.9375										
1	UELS305-100D1W3	1.0000										
30	UELS306D1W3	30	72	50	36.5	23	1.5	1	17.5	32.5	6.7	M8×1
¹ / ₁₆	UELS306-101D1W3	1.0625										
¹ / ₈	UELS306-102D1W3	1.1250	2.8346	1.969	1.4370	0.9055	0.059	0.039	0.689	1.280	0.264	⁵ / ₁₆ -24UNF
¹ / ₁₆	UELS306-103D1W3	1.1875										
35	UELS307D1W3	35	80	51.6	38.1	25	2	1	18.3	33.3	6.7	M8×1
¹ / ₄	UELS307-104D1W3	1.2500										
⁵ / ₁₆	UELS307-105D1W3	1.3125	3.1496	2.031	1.5000	0.9843	0.079	0.039	0.720	1.311	0.264	⁵ / ₁₆ -24UNF
¹ / ₄	UELS307-106D1W3	1.3750										
¹ / ₁₆	UELS307-107D1W3	1.4375										
40	UELS308D1W3	40	90	57.1	41.3	27	2	1	19.8	37.3	8	M10×1.25
¹ / ₂	UELS308-108D1W3	1.5000	3.5433	2.248	1.6260	1.0630	0.079	0.039	0.780	1.469	0.315	³ / ₈ -24UNF
⁹ / ₁₆	UELS308-109D1W3	1.5625										
45	UELS309D1W3	45	100	58.7	42.9	29	2	1	19.8	38.9	8	M10×1.25
⁵ / ₈	UELS309-110D1W3	1.6250										
¹¹ / ₁₆	UELS309-111D1W3	1.6875	3.9370	2.311	1.6890	1.1417	0.079	0.039	0.780	1.531	0.315	³ / ₈ -24UNF
¹ / ₄	UELS309-112D1W3	1.7500										
50	UCS210D1W3	50	110	66.6	49.2	32	2.5	1.5	24.6	42	8.7	M10×1.25
¹³ / ₁₆	UCS210-113D1W3	1.8125										
¹ / ₈	UCS210-114D1W3	1.8750	4.3307	2.622	1.9370	1.2598	0.098	0.059	0.969	1.654	0.343	³ / ₈ -24UNF
¹⁵ / ₁₆	UCS210-115D1W3	1.9375										
55	UELS311D1W3	55	120	73	55.6	34	2.5	1.5	27.8	45.2	8.7	M10×1.25
2	UELS311-200D1W3	2.0000										
¹ / ₁₆	UELS311-201D1W3	2.0625	4.7244	2.874	2.1890	1.3386	0.098	0.059	1.094	1.780	0.343	³ / ₈ -24UNF
¹ / ₈	UELS311-202D1W3	2.1250										
³ / ₁₆	UELS311-203D1W3	2.1875										

Note (1) These numbers indicate relubricatable type. If maintenance free type is needed, please order without suffix "D1".

Nominal dimensions			Basic load ratings		Mass
mm inch			N lbf		kg lb
d ₃	B ₅	F	dynamic C _r	static C _{or}	
42.8	15.9	4.3	21 200	10 900	0.45
					1.13
1.685	0.626	0.169	4 750	2 460	1.09
					1.05
					1.00
50	17.5	5.1	26 700	15 000	0.71
					1.62
1.969	0.689	0.201	6 000	3 400	1.56
					1.50
55	17.5	5.3	33 500	19 100	0.83
					1.99
2.165	0.689	0.209	7 500	4 300	1.91
					1.84
					1.76
63.5	20.6	5.6	40 500	24 000	1.12
					2.67
2.500	0.811	0.220	9 150	5 400	2.58
70	20.6	5.8	53 000	32 000	1.50
					3.26
2.756	0.811	0.228	11 900	7 200	3.37
					3.26
76.2	22.2	6.3	62 000	38 500	1.93
					4.55
3.000	0.874	0.248	13 900	8 600	4.44
					4.30
83	22.2	6.5	71 500	45 000	2.42
					5.76
3.268	0.874	0.256	16 100	10 100	5.57
					5.43
					5.26

Ball bearings Eccentric locking collar type

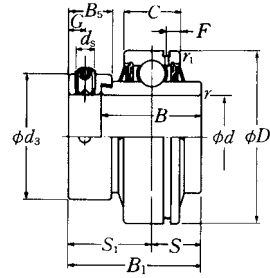

Shaft dia. mm inch	Bearing (1) number	Nominal dimensions										
		<i>d</i>	<i>D</i>	<i>B</i> ₁	<i>B</i>	<i>C</i>	mm inch		<i>S</i>	<i>S</i> ₁	<i>G</i>	<i>d</i> _s
							<i>r</i> min.	<i>r</i> ₁ min.				
60 2 1/4 2 9/16 2 3/8 2 7/16	UELS312D1W3 UELS312-204D1W3 UELS312-205D1W3 UELS312-206D1W3 UELS312-207D1W3	60 2.2500 2.3125 2.3750 2.4375	130	79.4	61.9	36	2.5	1.5	30.95	48.45	8.7	M10 × 1.25
65 2 1/2 2 9/16	UELS313D1W3 UELS313-208D1W3 UELS313-209D1W3	65 2.5000 2.5625	140	85.7	65.1	39	2.5	2	32.55	53.15	10.3	M12 × 1.5
70 2 5/8 2 1/2 2 3/4	UELS314D1W3 UELS314-210D1W3 UELS314-211D1W3 UELS314-212D1W3	70 2.6250 2.6875 2.7500	150	92.1	68.3	41	2.5	2	34.15	57.95	10.3	M12 × 1.5
75 2 3/4 2 7/8 2 5/8 3	UELS315D1W3 UELS315-213D1W3 UELS315-214D1W3 UELS315-215D1W3 UELS315-300D1W3	75 2.8125 2.8750 2.9375 3.0000	160	100	74.6	43	2.5	2	37.3	62.7	12.7	M16 × 1.5
80 3 1/16 3 1/8 3 1/16	UELS316D1W3 UELS316-301D1W3 UELS316-302D1W3 UELS316-303D1W3	80 3.0625 3.1250 3.1875	170	106.4	81	45	2.5	2	40.5	65.9	12.7	M16 × 1.5
85 3 1/4 3 5/16 3 7/16	UELS317D1W3 UELS317-304D1W3 UELS317-305D1W3 UELS317-307D1W3	85 3.2500 3.3125 3.4375	180	109.5	84.1	47	3	2.5	42.05	67.45	12.7	M16 × 1.5
90 3 7/16 3 1/2	UELS318D1W3 UELS318-307D1W3 UELS318-308D1W3	90 3.4375 3.5000	190	115.9	87.3	49	3	2.5	43.65	72.25	14.3	M20 × 1.5

Note (1) These numbers indicate relubricatable type. If maintenance free type is needed, please order without suffix "D1".

Nominal dimensions			Basic load ratings		Mass
mm inch			N lbf		kg lb
<i>d</i> ₃	<i>B</i> ₅	<i>F</i>	dynamic <i>C</i> _r	static <i>C</i> _{or}	
89	23.9	6.7	82 000	52 000	3.04
3.504	0.941	0.264	18 400	11 700	7.01
97	27	7.5	92 500	60 000	6.86
3.819	1.063	0.295	20 800	13 400	6.69
102	30.2	7.5	104 000	68 000	6.40
4.016	1.189	0.295	23 400	15 300	3.79
113	31.8	7.7	113 000	77 000	8.76
4.449	1.252	0.303	25 500	17 400	8.55
119	31.8	7.8	123 000	86 500	4.54
4.685	1.252	0.307	27 600	19 500	10.7
127	31.8	8.2	133 000	97 000	10.5
5.000	1.252	0.323	29 800	21 800	10.2
133	36.5	8.5	143 000	107 000	5.50
5.236	1.437	0.335	32 000	24 100	13.5
					13.2
					13.0
					12.9
					6.89
					15.3
					15.0
					15.3
					8.21
					18.2
					17.9
					17.2
					9.34
					21.2
					20.7

Ball bearings Eccentric locking collar type

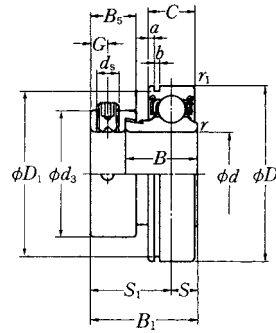

Shaft dia. mm inch	Bearing number	Nominal dimensions										
		d	D	B ₁	B	C	mm inch		S	S ₁	G	d _s
							r	r ₁				
12 1/2	AELS201NW3 AELS201-008NW3	12 0.5000	40 1.5748	28.6 1.126	19 0.7480	12 0.4724	0.6 0.024	0.6 0.024	6.5 0.256	22.1 0.870	4.8 0.189	M6×0.75 1/4"-28UNF
15 9/16 5/8	AELS202NW3 AELS202-009NW3 AELS202-010NW3	15 0.5625 0.6250	40 1.5748	28.6 1.126	19 0.7480	12 0.4724	0.6 0.024	0.6 0.024	6.5 0.256	22.1 0.870	4.8 0.189	M6×0.75 1/4"-28UNF
17 11/16	AELS203NW3 AELS203-011NW3	17 0.6875	40 1.5748	28.6 1.126	19 0.7480	12 0.4724	0.6 0.024	0.6 0.024	6.5 0.256	22.1 0.870	4.8 0.189	M6×0.75 1/4"-28UNF
20 3/4	AELS204NW3 AELS204-012NW3	20 0.7500	47 1.8504	31 1.220	21.5 0.8465	14 0.5512	1 0.039	0.6 0.024	7.5 0.295	23.5 0.925	4.8 0.189	M6×0.75 1/4"-28UNF
25 13/16 7/8 15/16 1	AELS205NW3 AELS205-013NW3 AELS205-014NW3 AELS205-015NW3 AELS205-100NW3	25 0.8125 0.8750 0.9375 1.0000	52 2.0472	31 1.220	21.5 0.8465	15 0.5906	1 0.039	0.6 0.024	7.5 0.295	23.5 0.925	4.8 0.189	M6×0.75 1/4"-28UNF
30 1 1/16 1 1/8 1 3/16 1 1/4	AELS206NW3 AELS206-101NW3 AELS206-102NW3 AELS206-103NW3 AELS206-104NW3	30 1.0625 1.1250 1.1875 1.2500	62 2.4409	35.7 1.406	23.8 0.9370	16 0.6299	1 0.039	0.6 0.024	9 0.354	26.7 1.051	6 0.236	M8×1 5/16"-24UNF
35 1 1/4 1 5/16 1 3/8 1 7/16	AELS207NW3 AELS207-104NW3 AELS207-105NW3 AELS207-106NW3 AELS207-107NW3	35 1.2500 1.3125 1.3750 1.4375	72 2.8346	38.9 1.531	25.4 1.0000	17 0.6693	1.5 0.059	0.6 0.024	9.5 0.374	29.4 1.157	6.8 0.268	M10×1.25 3/8"-24UNF
40 1 1/2 1 9/16	AELS208NW3 AELS208-108NW3 AELS208-109NW3	40 1.5000 1.5625	80 3.1496	43.7 1.720	30.2 1.1890	18 0.7087	1.5 0.059	0.6 0.024	11 0.433	32.7 1.287	6.8 0.268	M10×1.25 3/8"-24UNF

Nominal dimensions					Basic load ratings		Mass kg lb
d ₃	D ₁	mm inch		B ₅	N lbf		
		a	b		dynamic C _r	static C _{or}	
29 1.142	38.1 1.500	1.98 0.078	1.5 0.059	13.6 0.535	9 600 2 160	4 600 1 030	0.12 0.26
29 1.142	38.1 1.500	1.98 0.078	1.5 0.059	13.6 0.535	9 600 2 160	4 600 1 030	0.11 0.26 0.24
29 1.142	38.1 1.500	1.98 0.078	1.5 0.059	13.6 0.535	9 600 2 160	4 600 1 030	0.10 0.23
33 1.299	44.6 1.756	2.38 0.094	1.5 0.059	13.5 0.531	12 800 2 890	6 650 1 500	0.17 0.35
38 1.496	49.73 1.958	2.38 0.094	1.5 0.059	13.5 0.531	14 000 3 150	7 850 1 770	0.20 0.51 0.48 0.45 0.42
44.5 1.752	59.61 2.347	3.18 0.125	2.05 0.081	15.9 0.626	19 500 4 400	11 300 2 540	0.31 0.74 0.73 0.66 0.61
55.5 2.185	68.81 2.709	3.18 0.125	2.05 0.081	17.5 0.689	25 700 5 750	15 300 3 450	0.49 1.15 1.10 1.04 0.98
60 2.362	76.81 3.024	3.18 0.125	2.05 0.081	18.3 0.720	29 100 6 550	17 800 4 000	0.66 1.41 1.34

Ball bearings Eccentric locking collar type

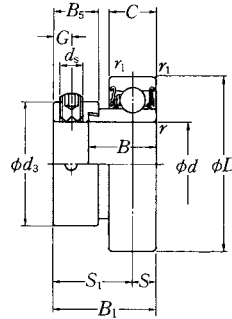

Shaft dia. mm inch	Bearing number	Nominal dimensions										
		<i>d</i>	<i>D</i>	<i>B</i> ₁	<i>B</i>	<i>C</i>	mm inch		<i>S</i>	<i>S</i> ₁	<i>G</i>	<i>d</i> ₃
							<i>r</i> min.	<i>r</i> ₁ min.				
12 1/2	JELS201W3 JELS201-008W3	12 0.5000	40 1.5748	28.6 1.126	19 0.7480	13 0.5118	0.6 0.024	0.4 0.016	6.5 0.256	22.1 0.870	4.8 0.189	M6×0.75 1/4-28UNF
15 9/16 5/8	JELS202W3 JELS202-009W3 JELS202-010W3	15 0.5625 0.6250	40 1.5748	28.6 1.126	19 0.7480	13 0.5118	0.6 0.024	0.4 0.016	6.5 0.256	22.1 0.870	4.8 0.189	M6×0.75 1/4-28UNF
17 11/16	JELS203W3 JELS203-011W3	17 0.6875	40 1.5748	28.6 1.126	19 0.7480	13 0.5118	0.6 0.024	0.4 0.016	6.5 0.256	22.1 0.870	4.8 0.189	M6×0.75 1/4-28UNF
20 3/4	JELS204W3 JELS204-012W3	20 0.7500	47 1.8504	31 1.220	21.5 0.8465	15 0.5906	1 0.039	0.6 0.024	7.5 0.295	23.5 0.925	4.8 0.189	M6×0.75 1/4-28UNF
25 13/16 7/8 15/16 1	JELS205W3 JELS205-013W3 JELS205-014W3 JELS205-015W3 JELS205-100W3	25 0.8125 0.8750 0.9375 1.0000	52 2.0472	31 1.220	21.5 0.8465	15 0.5906	1 0.039	0.6 0.024	7.5 0.295	23.5 0.925	4.8 0.189	M6×0.75 1/4-28UNF
30 1 1/16 1 1/8 1 3/16 1 1/4	JELS206W3 JELS206-101W3 JELS206-102W3 JELS206-103W3 JELS206-104W3	30 1.0625 1.1250 1.1875 1.2500	62 2.4409	35.7 1.406	23.8 0.9370	18 0.7087	1 0.039	1 0.039	9 0.354	26.7 1.051	6 0.236	M8×1 5/16-24UNF
35 1 1/4 1 5/16 1 3/8 1 1/2	JELS207W3 JELS207-104W3 JELS207-105W3 JELS207-106W3 JELS207-107W3	35 1.2500 1.3125 1.3750 1.4375	72 2.8346	38.9 1.531	25.4 1.0000	19 0.7480	1.5 0.059	1.5 0.059	9.5 0.374	29.4 1.157	6.8 0.268	M10×1.25 3/8-24UNF
40 1 1/2 1 9/16	JELS208W3 JELS208-108W3 JELS208-109W3	40 1.5000 1.5625	80 3.1496	43.7 1.720	30.2 1.1890	22 0.8661	1.5 0.059	1.5 0.059	11 0.433	32.7 1.287	6.8 0.268	M10×1.25 3/8-24UNF

Nominal dimensions mm inch		Basic load ratings N lbf		Mass kg lb
<i>d</i> ₃	<i>B</i> ₅	dynamic <i>C</i> _r	static <i>C</i> _{or}	
29 1.142	13.6 0.535	9 600 2 160	4 600 1 030	0.13 0.26
29 1.142	13.6 0.535	9 600 2 160	4 600 1 030	0.13 0.26 0.24
29 1.142	13.6 0.535	9 600 2 160	4 600 1 030	0.10 0.22
29 1.142	13.6 0.535	9 600 2 160	4 600 1 030	0.18 0.42
33 1.299	13.5 0.531	12 800 2 890	6 650 1 500	0.18 0.42
38 1.496	13.5 0.531	14 000 3 150	7 850 1 770	0.20 0.54 0.51 0.48 0.44
44.5 1.752	15.9 0.626	19 500 4 400	11 300 2 540	0.34 0.84 0.79 0.75 0.70
55.5 2.185	17.5 0.689	25 700 5 750	15 300 3 450	0.53 1.29 1.24 1.18 1.12
60 2.362	18.3 0.720	29 100 6 550	17 800 4 000	0.71 1.64 1.57

Ball bearings

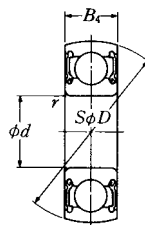

Shaft dia. mm	Bearing number	Nominal dimensions				Basic load ratings		Mass kg lb
		d	D mm inch	B_4	r min.	dynamic C_r N lbf	static C_{or} N lbf	
10	CS200LLU	10 0.3937	30 1.1811	9 0.3543	0.6 0.024	5 100 1 150	2 390 540	0.03 0.07
12	CS201LLU	12 0.4724	32 1.2598	10 0.3937	0.6 0.024	6 100 1 370	2 750 615	0.04 0.09
15	CS202LLU	15 0.5906	35 1.3780	11 0.4331	0.6 0.024	7 750 1 740	3 600 805	0.04 0.09
17	CS203LLU	17 0.6693	40 1.5748	12 0.4724	0.6 0.024	9 600 2 160	4 600 1 030	0.06 0.13
20	CS204LLU	20 0.7874	47 1.8504	14 0.5512	1 0.039	12 800 2 890	6 650 1 500	0.10 0.22
25	CS205LLU	25 0.9843	52 2.0472	15 0.5906	1 0.039	14 000 3 150	7 850 1 770	0.13 0.29
30	CS206LLU	30 1.1811	62 2.4409	16 0.6299	1 0.039	19 500 4 400	11 300 2 540	0.20 0.44
35	CS207LLU	35 1.3780	72 2.8346	17 0.6693	1.5 0.059	25 700 5 750	15 300 3 450	0.29 0.64
40	CS208LLU	40 1.5748	80 3.1496	18 0.7087	1.5 0.059	29 100 6 550	17 800 4 000	0.37 0.82



NSK used environmentally friendly paper and printing methods for this publication.

CAT. No. E1154f 2013 E-8 Printed in Japan ©NSK Ltd. First edition published in MAR. 2000



ویرا پرداز آروین پاسارگاد

با مدیریت خانم مهندس احمدی



جهت مشاوره

با کارشناسان فنی

با ما در ارتباط باشید



021 - 91001377



0935 125 90 98