



ویرا پرداز آروین پاسارگاد

با مدیریت خانم مهندس احمدی



جهت مشاوره

با کارشناسان فنی

با ما در ارتباط باشید



021 - 91001377



0935 125 90 98

Estd. 1983

DPI[®]
BEARINGS



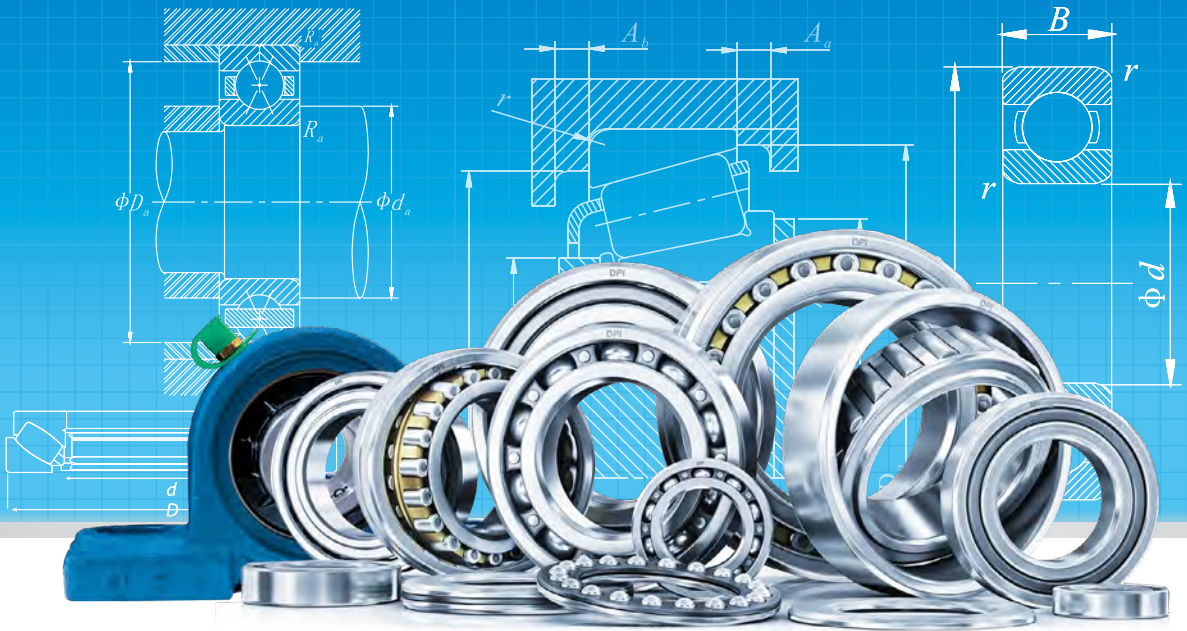





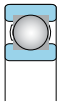
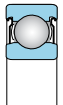
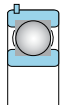
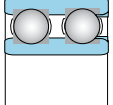

**GENERAL
CATALOGUE**

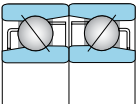
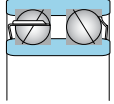
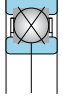
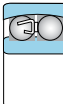

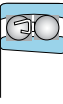
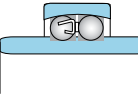
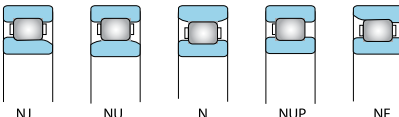
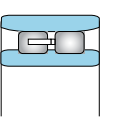
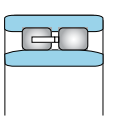
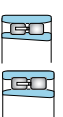
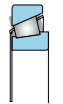
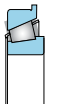
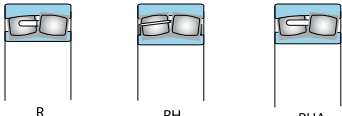
www.dpibearings.com

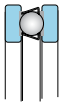
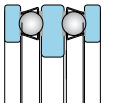
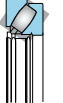
EPTDA
Member

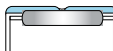
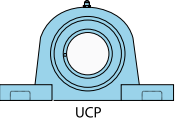
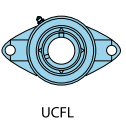
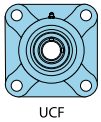
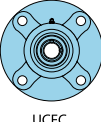
TUV NORD
ISO 9001:2008 CERTIFIED

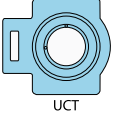
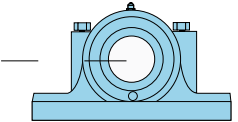
	Open Type Single Row Deep Groove Ball Bearing 68, 69, 160, 60,, 62, 63, 64		Sealed / Shielded Single Row Deep Groove Ball Bearing Z, RS		Single Row Locating Snap Ring Deep Groove Ball Bearing N, NR		Double Row Deep Groove Ball Bearing 42, 43					
	Single Row Angular Contact Ball Bearing 79, 70, 72, 73, 74, ACH9, ACH0		Matched Pair Single Row Angular Contact Ball Bearing DB, DF, DT		Double Row Angular Contact Ball Bearing 32, 33, 52, 53 52.....2RS, 53.....2RS		Four Point Contact Angular Contact Ball Bearing 62, 63					
	Cylindrical Bore Self Aligning Ball Bearing 12, 22 13, 23		Sealed Self Aligning Ball Bearing 22.....2RS 23.....2RS		Tapered Bore / Adaptor Ass. Self Aligning Ball Bearing K, H		Extended inner Ring Self Aligning Ball Bearing 112, 113					
	NJ NU N NUP NF	Single Row Cylindrical Roller Bearings NU10, NU2, NU22, NU32 NU3, NU23, NU33, NU4		Double Row Cylindrical Roller Bearings NN30		Double Row Cylindrical Roller Bearings NNU49		K Type Tapered Bore NN...K NNU...K				
			Metric Series Inch Series Tapered Roller Bearings 329, 320, 30, 331, 302, 322 332, 303, 303D, 313, 323		Flanged Type Tapered Roller Bearing							
		R RH RHA	Spherical Roller Bearings 239, 230, 240, 231, 241, 222, 232, 213, 223		Tapered Bore Spherical Roller BearingsK							
		Single Direction Thrust Ball Bearing 511, 512, 513, 514 ---, 532, 533, 534 ---, 532U, 533U, 534U		Double Direction Thrust Ball Bearing 522, 523, 524 542, 543, 544 542U, 543U, 544U		Spherical Roller Thrust Bearing 292, 293, 294						
			Needle Roller & Cage ass'y Needle Roller Bearings		Machined Ring Needle Roller Bearings							
	UCP		UCFL		UCF		UCFC		UCC		UCT	Cast Iron Ball Bearing Units 201 - 209, 310-328
							Split type Plummer block Units S,SD,SSN					

Bearings Specifications Table

Deep Groove Ball Bearings

Angular Contact Ball Bearings

Self Aligning Ball Bearings

Cylindrical Roller Bearings

Tapered Roller Bearings

Spherical Roller Bearings

Thrust Ball & Roller Bearings

Needle Roller Bearings

Ball Bearing Units

Plummer Blocks

Special Products

00	Introduction	5
01	Technical Introduction	6-39
02	Deep Groove Ball Bearings	40-65
03	Angular Contact Ball Bearings	66-81
04	Self Aligning Ball Bearings	82-91
05	Cylindrical Roller Bearings	92-111
06	Tapered Roller Bearings	112-147
07	Spherical Roller Bearings	148-161
08	Thrust Ball Bearings	162-177
09	Needle Roller Bearings	178-207
10	Ball Bearings Units	208-283
11	Plummer Blocks	284-287
12	Special Products	288-296

About the Company

DPI Bearings was established in the year 1983 in Pune, India. The company started its production with Ball bearings with technical collaboration with IKS - Japan and thereafter became a specialized producer of High Quality Tapered Roller bearings.

In 1984 DPI established a second plant in Pune, near Mumbai (West India) to enhance the ball bearing production. Later on an additional line of TRB bearings was also added into to the same plant.

The Company listed itself on the Bombay Stock Exchange in 1985. The plant established DPI as one of the premier manufacturers of Tapered Roller Bearings In India with Supplies to Top OEM in India. DPI began exporting bearings for the first time with initial exports bound for Middle East and South American markets.

Today 3 decades later, DPI is one of India Largest bearing brands exported worldwide with Sales Partners in more than 70 countries. Our production base consists of over 40 manufacturing sites. All products strictly follow all the latest ISO Standards and cover a comprehensive range of 4800 types of Industrial, Agricultural and Automotive bearings.

DPI has established a reputation in manufacturing high quality ball and roller bearings with an aim to save cost for our customers but not at the cost of quality. Since the first DPI bearing which were manufactured in 1983 in India, DPI today is one of India Fastest growing bearing manufacturer.

Our Product Portfolio consists of over 4800 types of Ball and Roller bearings which are in use in the Industrial, Agricultural and Automotive Applications.

Your advantages when you engage in a relation with us are:

- Reliability
- Fair market prices
- Availability
- Planning
- Quality

We thank you for your interest in DPI and we hope that you find this catalogue useful in understanding our products, philosophy, services and our commitment. We look forward to established a strong relation with you.

Every care has been taken to ensure the correctness of this information contained in this book but no liability can be accepted for any errors or omissions.

This book or parts thereof may not be reproduced without our permission.

Bearing Structure

General Construction

Most bearings consist of rings (inner and outer ring) with raceways, Rolling elements (balls or rollers) and a rolling element retainer (cage). The retainer separates the rolling elements within specific distance, holds them in place and allows them to rotate freely within the raceways of the bearings. The adjoining figures show the relative positioning of the rings, rolling elements and the retainers for the various types of bearings.

Characteristics of Bearings

Most bearings have very low friction coefficients. In general all bearings can carry radial and axial loads in varying capacities based on their type and construction. Ball bearings in general are used in applications that have high speed, high precision, low torque and lower vibration since they have lower frictional coefficients and lower face runout during rotation. Comparatively roller bearings are used in applications that have lower speeds, high loads and are subjected to torque and vibration forces.

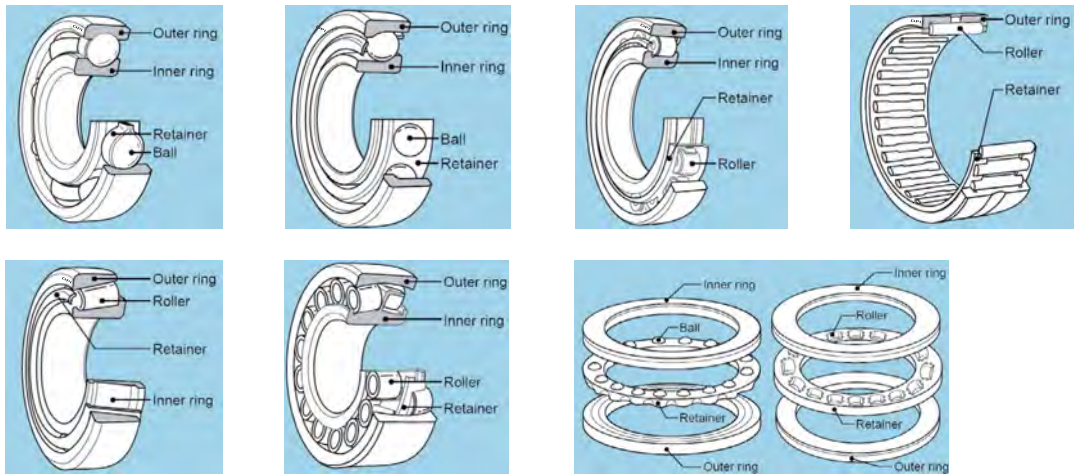

Selection of Bearings

Outline of Bearing Selection

Currently bearing design has become increasingly complex and diverse. A large part of the performance relies on the correct selection of the bearing. To select the most suitable bearing it is necessary to conduct a comprehensive study on bearings and the equipment in which the bearing will be installed, including operating conditions, performance required, specifications of other components to be installed along with the bearings and other criteria. Below is a quick guide which can be used for selection of the bearing.

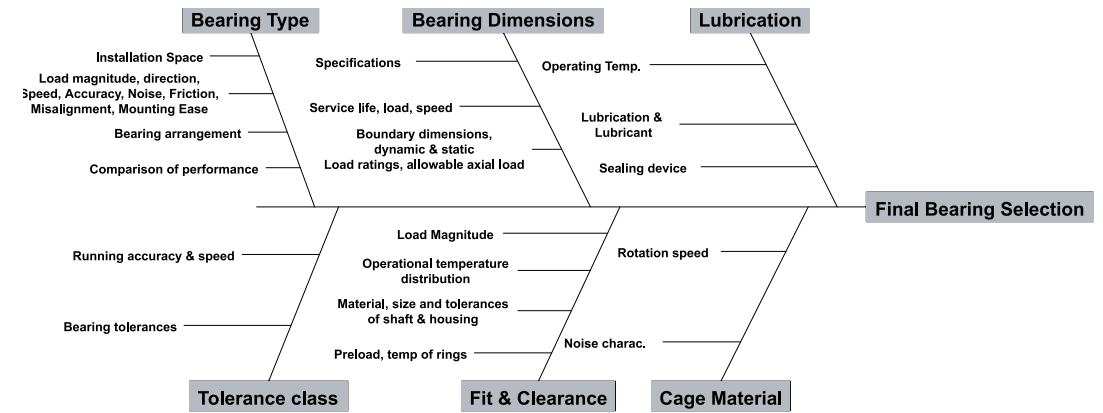

Selection of Bearing Arrangement

Bearings are further installed based on the arrangement of the bearing on the shaft and on the properties and operation of the shaft. Depending on availability of fixed and free side of the shaft different bearings can be used for the shaft.

Performance Comparison

	Deep Groove Ball Bearing	Angular Contact Ball Bearing			4 Point Contact Ball Bearing	Self Aligning Ball Bearing	Cylindrical Roller Bearing				Needle Roller Bearing	Taper Roller		Spherical Roller Bearing	Thrust Ball Bearing		Cylindrical Roller Thrust Bearing	Tapered Roller Thrust Bearing	Spherical Thrust Roller Bearing	
		Single Row	Matched Pair or Stack	Double Row			NU	NJ	NUP	NN		Single Row	Double Row		With Flat back faces	With Aligning Washer				
										N		NF	NH		NNU					
Load Resistance	Radial Load	○	○	☆	☆	○	○	☆	☆	☆	☆	☆	☆	☆	×	×	×	×	△	
	Axial Load	○	☆	☆	☆	☆	△	×	△	△	×	×	☆	☆	△	○	○	☆	☆	☆
	Combined Load Radial & Axial	○	○	☆	☆	○	△	×	△	△	×	×	☆	☆	△	×	×	×	×	△
	Vibration or Impact Load	△	△	△	△	△	△	☆	☆	☆	☆	○	☆	☆	☆	△	△	○	☆	☆
High Speed Adaptability	☆	☆	☆	○	☆	△	☆	☆	☆	☆	○	○	○	○	△	△	△	△	△	
High Accuracy	☆	☆	☆		☆		☆			☆		○		○						
Low Noise	☆						○													
Rigidity			○		○		○	○	○	☆		○	○	☆			☆	☆	☆	
Misalignment	○	△	×	×	×	☆	△	△	△	△		△	△	△	☆	×	☆	×	×	☆
Ring Seperability	×	×	×	×	■	×	■	■	■	■		■	■	■	×	■	■	■	■	■

Key

Excellent	---	☆
Good	---	○
Average	---	△
Acceptable	---	■
Not Acceptable	---	×

The above table is simply a basic guide which can be used for ready reference in selection of bearings. It is by no means comprehensive and should only be used as an indicator final bearing selection should be based after careful study and load calculations.

Bearing Rating Life

Load & Life Calculations

Bearings are subjected to two kinds of loads. Static loads and Dynamic loads. Static loads refer to loads applied to the bearing in stationary state (or nearly stationary state i.e. when $n < 10$ min.⁻¹). Dynamic loads are subjected to bearings when there is relative movement between the rings of the bearing. The theoretical rating life (length of time for which the bearing can operate without mechanical failure) calculation is standardized internationally as per the ISO 281 standard. This standard is based on Lundberg and Palmgren's theory of fatigue.

Basic Rating Life

The basic rating life calculated in accordance to ISO 281 is as below:

$$L = (C_r / P)^p \quad \text{where}$$

L = (Unit: Million Revolutions) Basic rating life in millions of revolutions reached or exceeded by a sufficiently large number of identical bearings before first indications of material fatigue appear

C_r = (Unit: Newton N) Basic dynamic load rating.

P = Equivalent Bearing load

p = Life exponent. Ball bearings; $p = 3$

The rating life is also expressed in operating hours and the formula for that is:

$$L = \frac{16667 \cdot L}{n} \quad \text{where}$$

n = (revolutions per min-rpm) operating speed.

Adjusted Rating life

The adjusted rating life in accordance to ISO 281 can be calculated if other influencing factors in addition to the speed and load are known. These factors include:

- special material properties
- Lubrication or
- If reliability over 90% is required.

$$L_{na} = a_1 \cdot a_2 \cdot a_3 \cdot L \quad \text{where}$$

L = Basic rating life

a1 = life adjustment factor for a reliability other than 90% (as shown below)

a2 = life adjustment factor for special material properties (standard Chromium steel: $a_2 = 1$)

a3 = life adjustment factor for special operating conditions - in particular related to lubrication

Reliability %	90	95	96	97	98	99
Reliability Coefficient	1	0.62	0.53	0.44	0.33	0.21

Industry Wise Required Rating Life

If no information is available then values from below general guide can be used to estimate the rating life required for different industries.

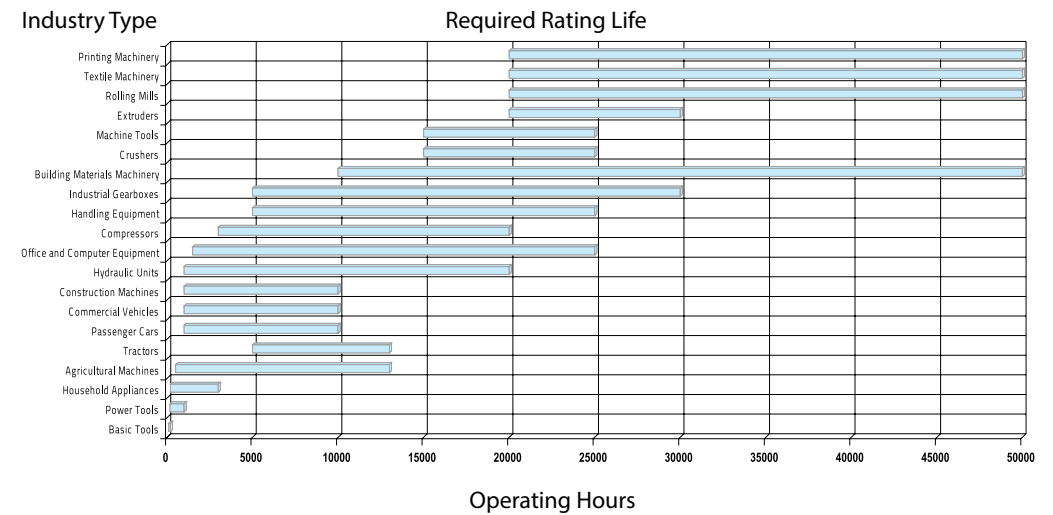

Correction of basic dynamic load rating for high temperature use

In high temperature operation bearing material hardness deteriorates, as material compositions are altered. As a result, the dynamic load rating is reduced. To account for this reduction the basic dynamic load rating is multiplied by the temperature coefficients shown below:

Bearing Temp	125 °	150 °	175 °	200 °	250 °
Temperature Coefficient	1	0.62	0.53	0.44	0.33

Boundary Dimensions & Bearing Numbers

Bearing Series Code		Bore Diameter Number		Contact Angle		
68	Ball brg	0.6	0.6mm	A	30 °(omit)	
69	Ball brg	1	1	AC	25 °	
60	Ball brg	1.5	1.5	B	40 °	Angular
329	TRB	9	9	C	15 °	Contact
				CA	20 °	Bearings
239	Sph Brg	00	10	E	35 °	
511	Thrust	01	12	B	<17 °(omit)	
		02	15	C	20 °	
		03	17	D	20 °30'	TRB
		04	25	DJ	28 °48'39"	
		96	480			
		500	500			
		2500	2500			

Shield / Seal Code		Ring Shape lubrication hole / Groover Code	
Z-ZZ	Fixed Shield	K	Inner Ring Tapered bore (1:12)
RS - 2RS	Contact	K30	Inner Ring Tapered bore (1:13)
LU - LLU	Contact	N	Snap Ring Groove on outer
		NR	Snap ring groove & Locating snap ring on outer
		NY	Creep preventing synthetic ring
		SG	Spiral groove on bore
		W	Lubrication Hole & Groove(Cyl)
		W33	Lubrication Hole & Groove(Sph)

Match Pair or Stack Code		Internal Clearance & Preload		
DB	Back to Back	C1	Smaller than C2	
DF	Face to Face	C2	Smaller than Standard	
DT	Tandem Arrangement	CN	Standard	Ball Bearings
		C3	Greater than Standard	

Boundary Dimensions & Bearing Numbers

		C4	Greater than C3	
		C5	Greater than C4	
		M1-M6	Radial Clearance	Miniature bearings
		CD2	Smaller than Standard	Double row angular contact
		CDN	Standard	
		CD3	Greater than Standard	
		CM	Radial Clearance for	Ball Bearing
		CT	Electric motor bearings	Cylindrical
		C1NA TO C5NA	Non interchangeable Clearance	Cylindrical
		S	Slight Preload	
		L	Light Preload	Angular Contact
		M	Medium Preload	
		H	Heavy Preload	

Tolerance Code	
omit	class 0
P6	class 6
P6X	class 6X
P5	class 5
P4	class 4
P2	class 2

Radial Bearing Tolerance (Tapered Roller Bearings excluded) - Inner Ring (bore Diameter)

Nominal bore diameter (d) mm		Single plane mean bore diameter deviation										Single bore diameter deviation			
		Δ dmp										D ds			
		class 0		class 6		class 5		class 4		class 2		class 4		class 2	
over	up to	upper	lower	upper	lower	upper	lower	upper	lower	upper	lower	upper	lower	upper	lower
0.6	2.5	0	-8	0	-7	0	-5	0	-4	0	-2.5	0	-4	0	-2.5
2.5	10	0	-8	0	-7	0	-5	0	-4	0	-2.5	0	-4	0	-2.5
10	18	0	-8	0	-7	0	-5	0	-4	0	-2.5	0	-4	0	-2.5
18	30	0	-10	0	-8	0	-6	0	-5	0	-2.5	0	-5	0	-2.5
30	50	0	-12	0	-10	0	-8	0	-6	0	-2.5	0	-6	0	-2.5
50	80	0	-15	0	-12	0	-9	0	-7	0	-4	0	-7	0	-4
80	120	0	-20	0	-15	0	-10	0	-8	0	-5	0	-8	0	-5
120	150	0	-25	0	-18	0	-13	0	-10	0	-7	0	-10	0	-7
150	180	0	-25	0	-18	0	-13	0	-10	0	-7	0	-10	0	-7
180	250	0	-30	0	-22	0	-15	0	-12	0	-8	0	-12	0	-8
250	315	0	-35	0	-25	0	-18	0	-15	0	-	0	-15	0	-
315	400	0	-40	0	-30	0	-23	0	-18	-	-	0	-18	0	-
400	500	0	-45	0	-35	0	-28	0	-23	-	-	0	-23	-	-
500	630	0	-50	0	-40	0	-35	-	-	-	-	-	-	-	-
630	800	0	-75	0	-50	0	-45	-	-	-	-	-	-	-	-
800	1000	0	-100	0	-60	0	-60	-	-	-	-	-	-	-	-
1000	1250	0	-125	0	-75	0	-75	-	-	-	-	-	-	-	-
1250	1600	0	-160	0	-	-	-	-	-	-	-	-	-	-	-
1600	2000	0	-200	0	-	-	-	-	-	-	-	-	-	-	-

Inner Ring (Bore Diameter) Tolerance: Continued

Single plane mean bore diameter deviation												Mean bore diameter variation				
Diameter series 7,8,9				Diameter series 0.1				Diameter series 2,3,4				V dmp				
class 0	class 6	class 5	class 4	class 0	class 6	class 5	class 4	class 0	class 6	class 5	class 4	class 0	class 6	class 5	class 4	class 2
max				max				max				max				
10	9	5	4	8	7	4	3	6	5	4	3	6	5	3	2	1.5
10	9	5	4	8	7	4	3	6	5	4	3	6	5	3	2	1.5
10	9	5	4	8	7	4	3	6	5	4	3	6	5	3	2	1.5
13	10	6	5	10	8	5	4	6	6	5	4	8	6	3	2.5	1.5
15	13	8	6	12	10	6	5	8	8	6	5	9	8	4	3	1.5
19	15	9	7	19	15	7	5	9	9	7	5	11	9	5	3.5	2
25	19	10	8	25	19	8	6	15	11	8	6	15	11	5	4	2.5
31	23	13	10	31	23	10	8	19	14	10	8	19	14	7	5	3.5
31	23	13	10	31	23	10	8	19	14	10	8	19	14	7	5	3.5
38	28	15	12	38	28	12	9	23	17	12	9	23	17	8	6	4
44	31	18	15	44	31	14	11	26	19	14	11	26	19	9	8	-
50	38	23	18	50	38	18	14	30	23	18	14	30	23	12	9	-
56	44	28	23	56	44	21	17	34	26	21	17	34	26	14	12	-
63	50	35	-	63	50	26	-	38	30	26	-	38	30	18	-	-
94	63	45	-	94	63	34	-	56	38	34	-	56	38	23	-	-
125	75	60	-	125	75	45	-	75	45	45	-	75	45	30	-	-
156	94	75	-	156	94	52	-	94	56	56	-	94	56	38	-	-
200	-	-	-	200	-	-	-	120	-	-	-	120	-	-	-	-
250	-	-	-	250	-	-	-	150	-	-	-	150	-	-	-	-

Inner Ring (Running Accuracy & Width) : Unit μm

Nominal bore diameter (d) mm		Radial runout of assembled bearing inner ring (kia)					Face runout with bore (sd)			Face runout with raceway (Sia)			Single inner ring width deviation (ΔBs)			
		class 0	class 6	class 5	class 4	class 2	class 5	class 4	class 2	class 5	class 4	class 2	class 0		class 6	
over	up to	max					max			max			upper	lower	upper	lower
0.6	2.5	10	5	4	2.5	1.5	7	3	1.5	7	3	1.5	0	40	0	40
2.5	10	10	6	4	2.5	1.5	7	3	1.5	7	3	1.5	0	120	0	120
10	18	10	7	4	2.5	1.5	7	3	1.5	7	3	1.5	0	120	0	120
18	30	13	8	4	3	2.5	8	4	2.5	8	4	2.5	0	120	0	120
30	50	15	10	5	4	2.5	8	4	2.5	8	4	2.5	0	120	0	120
50	80	20	10	5	4	2.5	8	5	2.5	8	5	2.5	0	150	0	150
80	120	25	13	6	5	2.5	9	5	2.5	9	5	2.5	0	200	0	200
120	150	30	18	8	6	2.5	10	6	2.5	10	7	2.5	0	250	0	250
150	180	30	18	8	6	5	10	6	4	10	7	5	0	250	0	250
180	250	40	20	10	8	5	11	7	5	13	8	5	0	300	0	300
250	315	50	25	13	10	-	13	8	-	15	9	-	0	350	0	350
315	400	60	30	15	13	-	15	9	-	20	12	-	0	400	0	400
400	500	65	35	20	15	-	18	11	-	25	15	-	0	450	0	450
500	630	70	40	25	-	-	25	-	-	30	-	-	0	500	0	500
630	800	80	50	30	-	-	30	-	-	35	-	-	0	750	0	750
800	1000	90	60	40	-	-	40	-	-	45	-	-	0	1000	0	1000
1000	1250	100	70	50	-	-	50	-	-	60	-	-	0	1250	0	1250
1250	1600	120	-	-	-	-	-	-	-	-	-	-	0	1600	0	1600
1600	2000	140	-	-	-	-	-	-	-	-	-	-	0	2000	0	2000

Single inner ring width deviation (ΔBs)						Single inner ring width deviation (ΔBs)						Inner ring width deviation (vBs)							
class 5		class 6		class 2		class 0		class 6		class 5		class 4,2		class 0	class 6	class 5	class 4	class 2	
upper	lower	upper	lower	upper	lower	upper	lower	upper	lower	upper	lower	upper	lower	max					
0	40	0	40	0	40	-	-	-	-	0	250	0	250	12	12	5	2.5	1.5	
0	40	0	40	0	40	0	250	0	250	0	250	0	250	15	15	5	2.5	1.5	
0	80	0	80	0	80	0	250	0	250	0	250	0	250	20	20	5	2.5	1.5	
0	120	0	120	0	120	0	250	0	250	0	250	0	250	20	20	5	2.5	1.5	
0	120	0	120	0	120	0	250	0	250	0	250	0	250	20	20	5	3	1.5	
0	150	0	150	0	150	0	380	0	380	0	250	0	250	25	25	6	4	1.5	
0	200	0	200	0	200	0	380	0	380	-	380	0	380	25	25	7	4	2.5	
0	250	0	250	0	250	0	500	0	500	0	380	0	380	30	30	8	5	2.5	
0	250	0	250	0	300	0	500	0	500	0	380	0	380	30	30	8	5	4	
0	300	0	300	0	350	0	500	0	500	0	500	0	500	30	30	10	6	5	
0	350	0	350	-	-	0	500	0	500	-	500	-	500	-	35	35	13	8	-
0	400	0	400	-	-	0	63	0	630	0	630	-	-	40	40	15	9	-	
0	450	0	450	-	-	0	800	-	800	-	-	-	-	50	45	18	11	-	
0	500	-	-	-	-	-	-	-	-	-	-	-	-	60	50	20	-	-	
0	750	-	-	-	-	-	-	-	-	-	-	-	-	70	60	23	-	-	
0	1000	-	-	-	-	-	-	-	-	-	-	-	-	80	60	35	-	-	
0	1250	-	-	-	-	-	-	-	-	-	-	-	-	100	60	45	-	-	
0	-	-	-	-	-	-	-	-	-	-	-	-	-	120	-	-	-	-	
0	-	-	-	-	-	-	-	-	-	-	-	-	-	140	-	-	-	-	

Radial Bearing Tolerance (Tapered Roller Bearings excluded) - Outer Ring
(Outer Diameter)

Nominal bore diameter (d) mm		Single plane mean bore diameter deviation										Single bore diameter deviation			
		Δ dmp										D ds			
		class 0		class 6		class 5		class 4		class 2		class 4		class 2	
over	up to	upper	lower	upper	lower	upper	lower	upper	lower	upper	lower	upper	lower	upper	lower
2.5	6	0	-8	0	-7	0	-5	0	-4	0	-2.5	0	-4	0	-2.5
6	18	0	-8	0	-7	0	-5	0	-4	0	-2.5	0	-4	0	-2.5
18	30	0	-9	0	-8	0	-6	0	-5	0	-4	0	-6	0	-4
30	50	0	-11	0	-9	0	-7	0	-6	0	-4	0	-6	0	-4
50	80	0	-13	0	-11	0	-9	0	-7	0	-4	0	-7	0	-4
80	120	0	-15	0	-13	0	-10	0	-8	0	-5	0	-8	0	-5
120	150	0	-18	0	-15	0	-11	0	-9	0	-5	0	-9	0	-5
150	180	0	-25	0	-18	0	-13	0	-10	0	-7	0	-10	0	-7
180	250	0	-30	0	-20	0	-15	0	-11	0	-8	0	-11	0	-8
250	315	0	-35	0	-25	0	-18	0	-13	0	-8	0	-13	0	-8
315	400	0	-40	0	-28	0	-20	0	-15	0	-10	0	-15	0	-10
400	500	0	-45	0	-33	0	-23	0	-17	-	-	0	-17	-	-
500	630	0	-50	0	-38	0	-28	0	-20	-	-	0	-20	-	-
630	800	0	-75	0	-45	0	-35	-	-	-	-	-	-	-	-
800	1000	0	-100	0	-60	0	-50	-	-	-	-	-	-	-	-
1000	1250	0	-125	0	-75	0	-63	-	-	-	-	-	-	-	-
1250	1600	0	-160	0	-90	0	-80	-	-	-	-	-	-	-	-
1600	2000	0	-200	0	-120	-	-	-	-	-	-	-	-	-	-
2000	2500	0	-250	-	-	-	-	-	-	-	-	-	-	-	-

Outer Ring (Diameter) Tolerance : continued

Single plane mean bore diameter deviation														Shielded/ Sealed type (Diameter series)		Mean bore diameter variation				
Diameter series 7,8,9				Diameter series 0.1				Diameter series 2,3,4				Total Dia	2,3,4	0,1,2,3,4	V dmp					
class 0	class 6	class 5	class 4	class 0	class 6	class 5	class 4	class 0	class 6	class 5	class 4	class 2	class 0	class 6	class 0	class 6	class 5	class 4	class 2	
max				max				max				max	max		max					
10	9	5	4	8	7	4	3	6	5	4	3	2.5	10	9	6	5	3	2	1.5	
10	9	5	4	8	7	4	3	6	5	4	3	2.5	10	9	6	5	3	2	1.5	
12	10	6	5	9	8	5	4	7	6	5	4	4	12	10	7	6	3	2.5	3	
14	11	7	6	11	9	5	5	8	7	5	5	4	16	13	8	7	4	3	2	
16	14	9	7	13	11	7	5	10	8	7	5	4	20	16	10	8	5	3.5	2	
19	16	10	8	19	16	8	6	11	10	8	6	5	26	20	11	10	5	4	2.5	
23	19	11	9	23	19	8	7	14	11	8	7	5	38	25	14	11	6	5	2.5	
31	23	13	10	31	23	10	8	19	14	10	8	7	-	30	19	14	7	5	3.5	
38	25	15	11	38	25	11	8	23	15	11	8	8	-	-	23	15	8	6	4	
44	31	18	13	44	31	14	10	26	19	14	10	8	-	-	26	19	9	7	4	
50	35	20	15	50	35	15	11	30	21	15	11	10	-	-	30	21	10	8	5	
56	41	23	17	56	41	21	15	34	25	17	13	-	-	-	34	25	12	9	-	
63	48	28	20	63	48	26	-	38	29	21	15	-	-	-	38	29	14	-	-	
94	56	35	-	94	56	38	-	55	34	26	-	-	-	-	55	34	18	-	-	
125	75	50	-	125	75	47	-	75	45	38	-	-	-	-	75	45	25	-	-	
156	94	63	-	156	94	60	-	94	56	47	-	-	-	-	94	56	31	-	-	
200	113	80	-	200	113	-	-	120	68	60	-	-	-	-	120	68	40	-	-	
250	150	-	-	250	150	-	-	150	90	-	-	-	-	-	150	90	-	-	-	
313	-	-	-	313	-	-	-	188	-	-	-	-	-	-	188	-	-	-	-	

Outer Ring (Running Accuracy & Width) : Unit μm

Nominal bore diameter (d) mm		Radial runout of assembled bearing inner ring (kia)					Sd			Sea			ΔCs		Ring width variation VCs			
		class 0	class 6	class 5	class 4	class 2	class 5	class 4	class 2	class 5	class 4	class 2	class 0,6,5,4,2		class 0,6	class 5	class 4	class 2
over	up to	max					max						upper	lower	max			
2.5	6	15	8	5	3	1.5	8	4	1.5	8	5	1.5				5	2.5	1.5
6	18	15	8	5	3	1.5	8	4	1.5	8	5	1.5				5	2.5	1.5
18	30	15	9	6	4	2.5	8	4	1.5	8	5	2.5				5	2.5	1.5
30	50	20	10	7	5	2.5	8	4	1.5	8	5	2.5				5	2.5	1.5
50	80	25	13	8	5	4	8	4	1.5	8	5	4				6	3	1.5
80	120	35	18	10	6	5	9	5	2.5	8	5	5				8	4	2.5
120	150	40	20	11	7	5	10	5	2.5	8	5	5				8	5	2.5
150	180	45	23	13	8	5	10	5	2.5	8	5	5				8	5	4
180	250	50	25	15	10	7	11	7	4	8	5	7				10	7	5
250	315	60	30	18	11	7	13	8	5	8	5	7				11	7	7
315	400	70	35	20	13	8	13	10	7	8	5	7				13	8	-
400	500	80	40	23	15	-	15	12	-	8	5	-				15	9	-
500	630	100	50	25	18	-	18	13	-	8	5	-				18	11	-
630	800	120	60	30	-	-	20	-	-	8	5	-				20	-	-
800	1000	140	75	40	-	-	23	-	-	8	5	-				23	-	-
1000	1250	160	85	45	-	-	30	-	-	8	5	-				30	-	-
1250	1600	190	95	60	-	-	45	-	-	8	5	-				45	-	-
1600	2000	220	110	-	-	-	-	-	-	8	5	-				-	-	-
2000	2500	250	-	-	-	-	-	-	-	8	5	-				-	-	-

Tolerances for Ball Bearings Inch Series- Inner & Outer Ring Width: Unit μm

Nominal bore diameter (d) mm		Single plane mean bore diameter deviation Δdmp				Single bore diameter deviation Δds				Single radial plane bore diameter variation Vdp			Mean bore diameter variation Vdmp	
		class 5P, 7P		class 9P		class 5P, 7P		class 9P		class 5P, 7P	class 9P		class 5P, 7P	class 9P
over	up to	upper	lower	upper	lower	upper	lower	upper	lower	max			max	
-	10	0	5.1	0	2.5	0	5.1	0	2.5	2.5	1.3		2.5	1.3
10	18	0	5.1	0	2.5	0	5.1	0	2.5	2.5	1.3		2.5	1.3
18	30	0	5.1	0	2.5	0	5.1	0	2.5	2.5	1.3		2.5	1.3

Tolerances for Ball Bearings Inch Series (Continued): Unit μm

Radial runout of assembled bearing inner ring $K\text{ia}$			Assembled bearing inner ring faceout with raceway			Face runout with bore Sd			Single inner or outer ring width deviation $\Delta\text{Bs}, \Delta\text{Cs}$		Inner or outer ring width variation Vbs, Vcs		
class 5P	class 7P	class 9P	class 5P	class 7P	class 9P	class 5P	class 7P	class 9P	class 5P,7P,9P		class 5P	class 7P	class 9P
max			max			max			upper	lower	max		
3.8	2.5	1.3	7.6	2.5	1.3	7.6	2.5	1.3	0	-25.4	5.1	2.5	1.3
3.8	2.5	1.3	7.6	2.5	1.3	7.6	2.5	1.3	0	-25.4	5.1	2.5	1.3
3.8	3.8	2.5	7.6	3.8	1.3	7.6	3.8	1.3	0	-25.4	5.1	2.5	1.3

Tolerance for Ball Bearings inch Series - Outer Ring : Unit μm

Nominal outside diameter (d) mm		Single plane mean bore diameter deviation Δdmp				Single bore diameter deviation Δds						Single radial plane bore diameter variation Vdp			Mean bore diameter variation Vdmp		
		class 5P, 7P		class 9P		class 5P, 7P			class 9P			class 5P, 7P	class 9P		class 5P, 7P	class 9P	
over	up to	upper	lower	upper	lower	Open type		Shielded/sealed type		Open type		Open type	Shielded/sealed type	Open type	Open type	Shielded/sealed type	Open type
-	18	0	5.1	0	2.5	0	5.1	1	-6.1	0	2.5	2.5	5.1	1.3	2.5	5.1	1.3
18	90	0	5.1	0	3.8	0	5.1	1	-6.1	0	3.8	2.5	5.1	2	2.5	5.1	2
30	50	0	5.1	0	3.8	0	5.1	1	-6.1	0	3.8	2.5	5.1	2	2.5	5.1	2

Tolerance for Ball Bearings inch Series (Continued) - Outer Ring : Unit μm

Radial runout of assembled bearing inner ring $K\text{ia}$			Assembled bearing inner ring faceout with raceway Sea			Variation of outside surface generatrix inclination with face SD			Single flange outside diameter deviation $^{\circ}\text{D1s}$		Single flange width deviation $^{\circ}\text{C1s}$	
class 5P	class 7P	class 9P	class 5P	class 7P	class 9P	class 5P	class 7P	class 9P	class 5P, 7P		class 5P, 7P	
max			max			max			upper	lower	upper	lower
5.1	3.8	1.3	7.6	2.5	1.3	7.6	2.5	1.3	0	-25.4	0	-50.8
5.1	3.8	2.5	7.6	2.5	1.3	7.6	2.5	1.3	0	-25.4	0	-50.8
5.1	5.1	2.5	7.6	3.8	1.3	7.6	3.8	1.3	0	-25.4	0	-50.8

Tolerances for Metric Series Tapered Roller Bearings- Cone: Unit μm

Nominal bore diameter (d) mm		Single plane mean bore diameter deviation								Single bore diameter deviation		Single radial plane bore diameter variation Vdp			
		D dmp								D ds		V dp			
over	up to	class 0		class 6		class 5		class 4		class 4		class 0	class 6	class 5	class 4
10	18	0	-12	0	-7	0	-7	0	-5	0	-5	12	7	5	4
18	30	0	-12	0	-8	0	-8	0	-6	0	-6	12	8	6	5
30	50	0	-12	0	-10	0	-10	0	-8	0	-8	12	10	8	6
50	80	0	-15	0	-12	0	-12	0	-9	0	-9	15	12	9	7
80	120	0	-20	0	-15	0	-15	0	-10	0	-10	20	15	11	8
120	180	0	-25	0	-18	0	-18	0	-13	0	-13	25	18	14	10
180	250	0	-30	0	-22	0	-22	0	-15	0	-15	30	22	17	11

Tolerances for Metric Series Tapered Roller Bearings (continued) Cone: Unit μm

Mean Bore diameter variation				Radial run out of assembled bearing cone				Face run out with bore		Sia	Single cone width deviation					
V dmp								D ds			D Bs					
class 0	class 6	class 5	class 4	class 0	class 6	class 5	class 4	class 5	class 4		class 4		class 6		class 5,4	
max				max				max		max	upper	lower	upper	lower	upper	lower
9	5	5	4	15	7	5	3	7	3	3	0	-120	0	-120	0	-200
9	6	5	4	18	8	5	3	8	4	4	0	-120	0	-120	0	-200
9	8	5	5	20	10	6	4	8	4	4	0	-120	0	-120	0	-240
11	9	6	5	25	10	7	4	8	5	4	0	-150	0	-150	0	-300
15	11	8	5	30	13	8	5	9	5	5	0	-200	0	-200	0	-400
19	14	9	7	35	18	11	6	10	6	7	0	-250	0	-250	0	-500
23	16	11	8	50	20	13	8	11	7	8	0	-300	0	-300	0	-600

Tolerances for Metric Series Tapered Roller Bearings- Cup: Unit μm

Nominal bore diameter (d) mm		Single plane mean bore diameter deviation								Single bore diameter deviation		Single radial plane bore diameter variation Vdp			
		D dmp								D ds		V dp			
		class 0		class 6		class 5		class 4		class 4		class 0	class 6	class 5	class 4
over	up to	upper	lower	upper	lower	upper	lower	upper	lower	upper	lower	max			
10	18	0	-12	0	-7	0	-7	0	-5	0	-6	12	8	6	5
18	30	0	-12	0	-8	0	-8	0	-6	0	-7	14	9	7	5
30	50	0	-12	0	-10	0	-10	0	-8	0	-9	16	11	8	7
50	80	0	-15	0	-12	0	-12	0	-9	0	-10	18	13	10	8
80	120	0	-20	0	-15	0	-15	0	-10	0	-11	20	15	11	8
120	180	0	-25	0	-18	0	-18	0	-13	0	-13	25	18	14	10
180	250	0	-30	0	-22	0	-22	0	-15	0	-15	30	20	15	11

Tolerances for Metric Series Tapered Roller Bearings- Cup: Unit μm -(continued)

Mean outside diameter variation				Radial run out of assembled bearing cone				SD		S ea	Single cup width deviation			
V dmp								D ds			D Cs			
class 0	class 6	class 5	class 4	class 0	class 6	class 5	class 4	class 5	class 4	class 4	class 4			
max				max				max		max	upper	lower	upper	lower
9	6	5	4	18	9	6	4	8	4	5	0	-100		
11	7	5	5	20	10	7	5	8	4	5	0	-100		
12	8	6	5	25	13	8	5	8	4	5	0	-100		
14	10	7	5	35	18	10	6	9	5	6	0	-100		
15	11	8	6	40	20	11	7	10	5	7	0	-100		
19	14	9	7	45	23	13	8	10	5	8	0	-100		
23	10	10	8	50	25	15	10	11	7	10	0	-100		

Confirms to the tolerance D Bs on d of the same bearing

Tolerances for Metric Series Tapered Roller Bearings- Bearing width & effective Width: Unit μm

Nominal bore diameter (d) mm		Actual Deviation width Δ Ts								Actual effective cone sub-unit width deviation ΔT2s				Actual effective cup sub-unit			
		class	0	class	6X	class	6	class	5,4	class	0	class	6X	class	0	class	6X
over	up to	upper	lower	upper	lower	upper	lower	upper	lower	upper	lower	upper	lower	upper	lower	upper	lower
10	18	200	0	100	0	200	0	200	-200	100	0	50	0	100	0	50	0
18	30	200	0	100	0	200	0	200	-200	100	0	50	0	100	0	50	0
30	50	200	0	100	0	200	0	200	-200	100	0	50	0	0	0	50	0
50	80	200	0	100	0	200	0	200	-200	100	0	50	0	100	0	50	0
80	120	200	-200	100	0	200	-200	200	-200	100	-100	50	0	100	-100	50	0
120	180	350	-250	150	0	350	-250	350	-250	150	-150	50	0	200	-100	100	0
180	250	350	-250	150	0	350	-250	350	-250	150	-150	50	0	200	-100	100	0
250	315	400	-250	200	0	400	-250	400	-250	200	-150	100	0	200	-100	100	0
315	400	400	-400	200	0	400	-400	400	-400	200	-200	100	0	200	-200	100	0
400	500	400	-400	-	-	400	-400	400	-400	-	-	-	-	-	-	-	-
500	630	500	-500	-	-	500	-500	500	-500	-	-	-	-	-	-	-	-
630	800	600	-600	-	-	600	-600	600	-600	-	-	-	-	-	-	-	-
800	1000	750	-750	-	-	750	-750	750	-750	-	-	-	-	-	-	-	-

Tolerances for Metric Series Double Row and Four Row Tapered roller Bearings: Unit μm (1) Cone, Cup and overall Width

Nominal bore diameter (d)		Single plane mean bore	Single radial	Mean bore diameter	Radial runout	Single cup or cone width deviation	Actual overall cones/ cups width deviation							
							Δ dmp		Vdp	Vdmp	K1a	ΔBs, ΔCs		Double row ΔTs
over	up to	upper	lower	max	max	max	upper	lower	upper	lower	upper	lower	upper	lower
30	50	0	12	12	7	20	-	-	240	-240	-	-	-	-
50	80	0	15	15	11	25	-	-	300	-300	-	-	-	-
80	120	0	20	20	15	30	0	-200	400	-400	500	500	500	500
120	180	0	25	25	17	35	0	-250	500	-500	600	600	600	600
180	250	0	30	30	23	50	0	-300	600	-600	750	750	750	750
250	315	0	35	35	26	60	0	-350	700	-700	900	900	900	900
315	400	0	40	40	30	70	0	-400	800	-800	1000	1000	1000	1000
400	500	0	45	45	34	80	0	-450	900	-900	1200	1200	1200	1200
500	630	0	50	50	38	90	0	-500	1000	-1000	1200	1200	1200	1200
630	800	0	75	75	56	105	0	-750	1500	-1500	-	-	-	-
800	1000	0	100	100	75	120	-	-	1500	-1500	-	-	-	-

Tolerances for Metric Series Double Row and Four Row Tapered roller Bearings: Unit μm (2) Cup

Nominal bore diameter (d) mm		Single plane mean bore diameter deviation Δdmp		Single radial plane VDP	Mean Outside Diameter variation VDMp	Radial Runout Kea
over	up to	upper	lower	max	max	max
50	80	0	16	16	12	25
60	120	0	18	18	14	35
120	150	0	20	20	15	40
150	180	0	25	25	17	45
180	250	0	30	30	23	50
250	315	0	35	35	26	60
315	400	0	40	40	30	70
400	500	0	45	45	34	80
500	630	0	50	50	38	100
630	800	0	75	75	56	120
800	1000	0	100	100	75	140
1000	1250	0	125	125	81	165
1250	1600	0	160	160	120	190

(2) Housing Washer

Nominal outside diameter (D) mm		Single plane mean outside diameter deviation Δdmp				Single radial plane mean outside diameter deviation VDP		Washer raceway to back thickness variation Se							
over	up to	classes 0,6,5		class 4		class 0,6,5	class 4	class 0	class 6	class 5	class 4				
		upper	lower	upper	lower	max		max							
10	18	0	-11	0	-7	8	5	Shall confirm to tolerance Si on d or d2 of the same bearing							
18	30	0	-13	0	-8	10	6								
30	50	0	-16	0	-9	12	7								
50	80	0	-19	0	-11	14	8								
80	120	0	-22	0	-13	17	10								
120	180	0	-25	0	-15	19	11								
180	250	0	-30	0	-20	23	15								
250	315	0	-35	0	-25	26	19								
315	400	0	-40	0	-28	30	21								
400	500	0	-45	0	-33	34	25								
500	630	0	-50	0	-38	38	29								
630	800	0	-75	0	-45	55	34								
800	1000	0	-100	-	-	75	-								
1000	1250	0	-125	-	-	-	-								
1250	1600	0	-160	-	-	-	-								

Tolerances for Thrust Ball Bearings (1) Shaft Washer and Central washer

Nominal bore diameter of shaft or central washer		Single plane mean bore diameter deviation d or d2 mm Δdmp or Δd2mp				Single radial plane mean bore diameter deviation		Thickness variation S1			
over	up to	classes 0,6,5		classes 0,6,5		class 4	class 4	class 0	class 6	class 5	class 4
		upper	lower	upper	lower					max	max
-	18	0	8	0	-7	6	5	10	5	3	2
18	30	0	1	0	-8	8	6	10	5	3	2
30	50	0	12	0	-10	9	8	10	6	3	2
50	80	0	15	0	-12	11	9	10	7	4	3
80	120	0	20	0	-15	15	11	15	8	4	3
120	180	0	25	0	-18	19	14	15	9	5	4
180	250	0	30	0	-22	23	17	20	10	5	4
250	315	0	35	0	-25	26	19	25	13	7	5
315	400	0	40		-30	30	23	30	15	7	5
400	500	0	45	0	-35	34	26	30	18	9	6
500	630	0	50	0	-40	38	30	35	21	11	7
630	800	0	75	0	-50	-	-	40	25	13	8
800	1000	0	100	-	-	-	-	45	30	15	-
1000	1250	0	125	-	-	-	-	50	25	18	-

Bearings Height and Central Washer Height

Nominal outside diameter (D) mm		Single Direction		Double Direction					
over	up to	Deviation of the actual bearing height T ΔT s		Deviation of the actual bearing height T1 ΔT1S		Deviation of the actual bearing height T2 ΔT2s		Deviation of a single central washer height B ΔBs	
		class 0		class 0		class 0		class 0	
		upper	lower	upper	lower	upper	lower	upper	lower
-	30	0	-75	50	-150	0	-75	0	-50
30	50	0	-100	75	-200	0	-100	0	-75
50	80	0	-125	100	-250	0	-125	0	-100
80	120	0	-150	125	-300	0	-150	0	-125
120	180	0	-175	150	-350	0	-175	0	-150
180	250	0	-200	175	-400	0	-200	0	-175
250	315	0	-225	200	-450	0	-225	0	-200
315	400	0	-300	250	-600	0	-300	0	-250

Permissible values for chamber dimensions washer

Metric series TRB

r min OR R1 min	Nominal bore diameter d m		Radial Direction	Axial Direction
	over	up to	r max or r1 max	
0.3	-	40	0.7	1.4
	40	-	0.9	1.6
0.6	-	40	1.1	1.7
	40	-	1.3	2
1	-	50	1.6	2.5
	50	-	1.9	3
1.5	-	120	2.3	3
	120	250	2.8	3.5
	250	-	3.5	4
2	-	120	2.8	4
	120	250	3.5	4.5
	250	-	4	5
2.5	-	120	3.5	5
	120	250	4	5.5
	250	-	4.5	6
3	-	120	4	5.5
	120	250	4.5	6.5
	250	400	5	7
	400	-	5.5	7.5
4	-	120	5	7
	120	250	5.5	7.5
	250	400	6	8
	400	-	6.5	8.5
5	-	180	6.5	8
	180	-	7.5	9
6	-	180	7.5	10
	180	-	9	11
7.5	-	-	12.5	17
9.5	-	-	15	19

Metric series TRB

r min OR R1 min	Nominal bore diameter d m
	r max or r1 max
0.05	0.1
0.08	0.16
0.1	0.2
0.15	0.3
0.2	0.5
0.3	0.8
0.6	1.5
1	2.2
1.1	2.7
1.5	3.5
2	4
2.1	4.5
3	5.5
4	6.5
4	8
6	10
7.5	12.5
9.5	15
12	18
15	21
19	25

(1) Radial Bearing (TRB excluded)

r min OR R1 min	Nominal bore diameter d m		Radial Direction	Axial Direction
	over	up to	r max or r1 max	
0.5	-	-	0.1	0.2
	0.08	-	0.16	0.3
0.1	-	-	0.2	0.4
	0.15	-	0.3	0.6
0.2	-	-	0.5	0.8
	-	40	0.6	1
0.3	40	-	0.8	1
	-	40	1	2
0.6	40	-	1.3	2
	-	50	1.5	3
1	50	-	1.9	3
	-	120	2	3.5
1.1	120	-	2.5	4
	-	120	2.3	4
1.5	120	-	3	5
	-	80	3	4.5
2	80	220	3.5	5
	220	-	3.8	6
2.1	-	280	4	6.5
	280	-	4.5	7
2.5	-	100	3.8	6
	100	280	4.5	6
3	280	-	5	7
	-	280	5	8
4	280	-	5.5	8
	-	-	6.5	9
5	-	-	8	10
6	-	-	10	13
7.5	-	-	12.5	17
9.5	-	-	15	19
12	-	-	18	24
15	-	-	21	30
19	-	-	25	38

Bearing Clearances

The bearing clearance is the measurement by which one bearing ring can be displaced in relation to the other one either in the radial direction (radial clearance) or in the axial direction (axial clearance) from one end position to the other. In the case of some bearing types radial and axial clearances depend on each other.

There is a distinction made between the clearance of the bearing prior to mounting and the clearance of the mounted bearing at operating temperature (operating clearance). The operating clearance should be as small as possible for the shaft to be guided perfectly. The clearance of the non-mounted bearing is reduced during mounting due to tight fits of the bearing rings.

As a rule, it therefore has to be larger than the operating clearance. The radial clearance is also reduced during operation when the inner ring becomes warmer than the outer ring, which is usually the case.

DIN 620 specifies standard values for the radial clearance of bearings. The normal clearance of rolling bearings. The normal clearance (clearance group CN) is calculated in such a way that the bearing has unappropriate operating clearance under common mounting and operating conditions.

Normal fits are:

Shaft Housing

Ball Bearing – j5...k5 H7...J7

Roller Bearing - k5...m5 H7...M7

Mounting and service conditions which deviate, such as tight fits for both bearing rings or temperature difference > 10K, make more radial clearance group necessary. The suitable clearance group is calculated.

Suffixes for the clearance groups according to DIN 620:

C2 Radial clearance smaller than normal (CN)

C3 Radial clearance larger than normal (CN)

C4 Radial clearance larger than C3

Reduction of the radial clearances by means of temperature differences:

The reduction of the radial clearances Δ_{grt} by means of temperature differences Δt (K) for non adjusted bearings is approximately:

$$\Delta_{grt} = \Delta t \cdot \alpha \cdot (d+D)/2 \text{ (mm)}$$

Where

$\alpha = 0.000011K-1$ Linear thermal expansion coefficient of the steel

d-Bearing bore(mm)

D- Bearing outside diameter (mm)

A greater change in radial clearance can be expected when the bearing position is exposed to the input or dissipation of heat. A smaller radial clearance results from heat input through the shaft or heat dissipation through the housing. A larger radial clearance results from heat input through the housing or heat dissipation through the shaft. Rapid run-up of the bearings to operating speed results in greater differences in temperature between the bearing rings than is the case in a steady state. Either the bearings should be run up slowly or a larger radial clearance than theoretically necessary for the bearing when under operating temperatures should be selected in order to prevent detrimental preload and bearing deformation.

Reduction and radial clearance by means of tight fits:

The expansion of the inner ring raceway and the constriction of the outer ring raceway can be assumed to be approximately 80% and 70% of the interference respectively. (Preconditions: solid steel shaft, steel housing with normal wall thickness).

Radial Internal Clearance for Deep Groove Ball Bearing (Cylindrical Bore)

Nominal bore diameter (d) mm		Clearance									
		C2		CN		C3		C4		C5	
over	up to	min	max	min	max	min	max	min	max	min	max
2.5	6	0	7	2	13	8	23	14	29	20	37
6	10	0	7	2	13	8	23	14	29	20	37
10	18	0	9	3	18	11	25	18	33	25	45
18	24	0	10	5	20	13	28	20	36	28	48
24	30	1	11	5	20	13	28	23	41	30	53
30	40	1	11	6	20	15	33	28	46	40	54
40	50	1	11	6	23	18	36	30	51	45	73
50	65	1	15	8	28	23	43	38	61	55	90
65	80	1	15	10	30	25	51	46	71	65	105
80	100	1	18	12	36	30	58	53	84	75	120
100	120	2	20	15	41	36	66	61	97	90	140
120	140	2	23	18	48	41	81	71	114	105	160
140	160	2	23	18	53	46	91	81	130	120	180
160	180	2	25	20	61	53	102	91	147	135	200
180	200	2	30	25	71	63	117	107	163	105	230

Correction Table

Nominal bore diameter (d) mm		Measurement load	Amount of clearance correction in microns					
			C2		CN	C3	C4	C5
over	up to	N	max	min	max	min	max	min
2.5	18	24.5	3	4	4	4	4	4
18	50	49	4	5	5	6	6	6
50	280	147	6	8	8	9	9	9

Radial Internal Clearance for Self Aligning Ball Bearings (Cylindrical Bore)

Nominal bore diameter (d) mm		Clearance									
		C2		CN		C3		C4		C5	
over	up to	min	max	min	max	min	max	min	max	min	max
2.5	6	1	8	5	15	10	20	15	25	21	33
6	10	2	9	6	17	12	25	19	33	27	42
10	14	2	10	6	19	13	26	21	35	30	48
14	18	3	12	8	21	15	28	23	37	32	50
18	24	4	14	10	23	17	30	25	39	34	52
24	30	5	16	11	24	19	35	29	46	40	58
30	40	6	18	13	29	23	40	34	53	46	66
40	50	6	19	14	31	25	44	37	57	50	71
50	65	7	21	16	36	30	50	45	69	62	88
65	80	8	24	18	40	35	60	54	83	76	108
80	100	9	27	22	48	42	70	64	96	89	124
100	120	10	31	25	56	50	83	75	114	105	145
120	140	10	38	30	68	60	100	90	135	125	175
140	160	15	44	35	80	70	120	110	161	150	210

Radial Internal Clearance for Cylindrical Roller Bearing (Cylindrical Bore)

Nominal bore diameter (D) mm		Clearance									
		C2		CN		C3		C4		C5	
over	up to	min	max	min	max	min	max	min	max	min	max
	10	0	25	20	45	35	60	50	75		
10	24	0	25	20	45	35	60	50	75	65	90
24	30	0	25	20	45	35	60	50	75	70	95
30	40	5	30	25	50	45	70	60	85	80	105
40	50	5	35	30	60	50	80	70	100	95	125
50	65	10	40	40	70	60	90	80	110	110	140
65	80	10	45	40	75	65	100	90	125	130	165
80	100	15	50	50	85	75	110	105	140	155	190
100	120	15	55	50	90	85	125	125	165	180	220
120	140	15	60	60	105	100	145	145	190	200	245
140	160	20	70	70	120	115	165	165	215	225	275
160	180	25	75	75	125	120	170	170	220	250	300
180	200	35	90	90	145	140	195	195	250	275	330

Radial Internal Clearance for Self Aligning Ball Bearings (Tapered Bore)

Nominal bore diameter (d) mm		Clearance									
		C2		CN		C3		C4		C5	
over	up to	min	max	min	max	min	max	min	max	min	max
18	24	7	17	13	26	20	33	28	42	37	55
24	30	9	20	15	28	23	39	33	50	44	62
30	40	12	24	19	35	29	46	40	59	52	72
40	50	14	27	22	39	33	52	45	65	58	79
50	65	18	32	27	47	41	61	56	80	73	99
65	80	23	39	35	57	50	75	69	98	91	123
80	100	29	47	42	68	62	90	84	116	109	144
100	120	35	56	50	81	75	108	100	139	130	170
120	140	40	68	60	98	90	130	120	165	155	205
140	160	45	74	65	110	100	150	140	191	180	240

Radial Internal Clearance for Spherical Roller Bearings (Cylindrical Bore)

Nominal bore diameter (d) mm		Clearance									
		C2		CN		C3		C4		C5	
over	up to	min	max	min	max	min	max	min	max	min	max
14	18	10	20	20	35	35	45	45	60	60	75
18	24	10	20	20	35	35	45	45	60	60	75
24	30	15	25	25	40	40	55	55	75	75	95
30	40	15	30	30	45	45	60	60	80	80	100
40	50	20	35	35	55	55	75	75	100	100	125
50	65	20	40	40	65	65	90	90	120	120	150
65	80	30	50	50	80	80	110	110	145	145	180
80	100	35	60	60	100	100	135	135	180	180	225
100	120	40	75	75	120	120	160	160	210	210	260
120	140	50	95	95	145	145	190	190	240	240	300
140	160	60	110	110	170	170	220	220	280	280	350
160	180	65	120	120	180	180	240	240	310	310	390
180	200	70	130	130	200	200	260	260	340	340	430
200	225	80	140	140	220	220	290	290	380	380	470
225	250	90	150	150	240	240	320	320	420	420	520
250	280	100	170	170	260	260	350	350	460	460	570
280	315	110	190	190	280	280	370	370	500	500	630
315	355	120	200	200	310	310	410	410	550	550	690
355	400	130	220	220	340	340	450	450	600	600	750
400	450	140	240	240	370	370	500	500	660	660	820
450	500	140	260	260	410	410	550	550	720	720	900
500	560	150	280	280	440	440	600	600	780	780	1000

Radial Internal Clearance for Spherical Roller Bearings (Cylindrical Bore)

Nominal bore diameter (d) mm		Clearance									
		C2		CN		C3		C4		C5	
over	up to	min	max	min	max	min	max	min	max	min	max
18	24	15	25	25	35	35	45	45	60	60	75
24	30	20	30	30	40	40	55	55	75	75	95
30	40	25	35	35	50	50	65	65	85	85	105
40	50	30	45	45	60	60	80	80	100	100	130
50	65	40	55	55	75	75	95	95	120	120	160
65	80	50	70	70	95	95	120	120	150	150	200
80	100	55	80	80	110	110	140	140	180	180	230
100	120	65	100	100	135	135	170	170	220	220	280
120	140	80	120	120	160	160	200	200	260	260	330
140	160	90	130	130	180	180	230	230	300	300	380
160	180	100	140	140	200	200	260	260	340	340	430
180	200	110	160	160	220	220	290	290	370	370	470
200	225	120	180	180	250	250	320	320	410	410	520
225	250	140	200	200	270	270	350	350	450	450	570
250	280	150	220	220	300	300	390	390	490	490	620
280	315	170	240	240	330	330	430	430	540	540	680
315	355	190	270	270	360	360	470	470	590	590	740
355	400	210	300	300	400	400	520	520	650	650	820
400	450	230	330	330	440	440	570	570	720	720	910
450	500	260	370	370	490	490	630	630	790	790	1000
500	560	290	410	410	540	540	680	680	870	870	1100

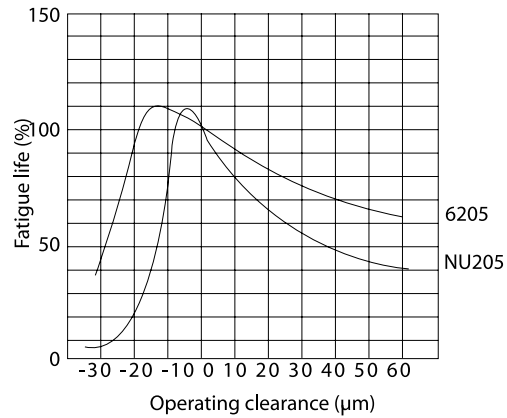

General Construction of Bearings

Preload Definition

For some applications bearings are mounted with certain amount of axial load so that the clearance of the bearing is negative. This kind of load is known as “preload” and is very often applied to tapered roller and angular contact ball bearings.

Preload Purpose

The purpose of the preload is as follows:

- a) To Improve the running accuracy
- b) To Improve gear engagement accuracy by increasing rigidity
- c) To reduce smearing by reducing sliding in irregular rotation
- d) To minimize abnormal noise due to vibration
- e) To keep rolling elements in right position relative to raceway.

Preload Methods

Application of preload is achieved in one of the following ways:

- 1) Position Preloading
- 2) Constant Pressure Preloading

Method of Preloading

	Position preloading		Constant pressure preloading
	* Method using matched pair bearing with stand-out adjusted for preloading (see below).	* Method using spacer with dimensions adjusted for preloading.	* Method using nut or bolt capable of adjusting preload in axial direction.
			In this case, starting friction moment during adjustment should be measured so that proper preload will be applied.

Lubrication Purpose

Lubrication is one of the most important factors determining bearing performance. The suitability of the lubricant and lubrication method have a strong influence on bearing life.

Lubrication has the following function:

- a) To lubricate each part of the bearing and reduce friction and wear
- b) To carry away heat generated inside bearing due to friction.
- c) To cover rolling contact surface with the proper oil film.
- d) To Prevent corrosion and contamination

Type of Lubrication

Bearing lubrication is classified broadly into :

- a) Grease Lubrication
- b) Oil Lubrication

The main differences between them are as follows:

Item	Grease	Oil
Sealing	Easy	Slightly complicated and special care required
Lubricating ability	Good	Excellent
Rotation speed	Low/medium	Applicable at high speed
Replacement of lubricant	Slightly troublesome	Easy
Life of lubricant	Relatively short	Long
Cooling effect	No cooling effect	Good (with circulation)
Filtration of dirt	Difficult	Easy

DPI DGMT 3 Grease

For best results use DPI DGMT 3 Grease. This is specially formulated in the EU with wide use all over the world with our customers and bearings.



Material

Bearing materials include steel for bearing rings and rolling elements, as well as steel sheet, steel, copper alloy and synthetic resins for cages. These bearing materials should possess the following characteristics :

- 1) High elasticity, durable under high partial contact stress.
 - 2) High strength against rolling contact fatigue due to large repetitive contact load.
 - 3) Strong hardness
 - 4) High abrasion resistance
 - 5) High toughness against impact load
 - 6) Excellent dimensional stability
- > Bearing ring
 > Rolling elements
 > Cages

1) High Carbon Chromium Bearing Steel

High carbon chromium bearing steel specified in Indian/Chinese Standard is used as a general material in bearing (inner rings, outer rings) and rolling elements (balls, rollers). Among these steel types, SUJ 2 is generally used. SUJ 3, which contains additional Mn and Si, possesses high hardenability and is commonly used for thick section bearings. SUJ 5 has increased hardenability, because it was developed by adding Mo to SUJ 3 for small and medium sized bearings, SUJ 2 and SUJ 3 are used, and for large size and extra-large size bearings with thick sections, SUJ 5 is widely used. Generally, these materials are processed into the specified shape and then undergo hardening and annealing treatment until they attain a hardness of 57 to 64 HRC.

2) Case Carburizing Bearing Steel (Case Hardened Steel)

When a bearing receives heavy impact loads, the surface of the bearing should be hard and the inside soft. Such materials should possess a proper amount of carbon, dense structure, and carburizing case depth on their surface, while having proper hardness and fine structure internally. For this purpose, chromium steel and nickelchromium - molybdenum steel are used as materials.

These materials also undergo vacuum degassing in order to reduce nonmetallic inclusions and oxygen content which leads to higher reliability.

Materials

3) Others

For special applications, the following materials are used, according to operational conditions.

(When very high reability is required)

*high refining steel...developed by us

*vaccum arc remelted steel

*electro slag remelted steel

(When heat resistance is required)

*high speed steel for high temperature bearings

(When high corrosion resistance is required)

*stainless steel.

(When high heat, corrosion, and chemical resistance are required)

*ceramics

Chemical composition of high carbon chromium bearing steel

Standard	Code	Chemical composition (%)						
		C	Si	Mn	P	S	Cr	Mo
JIS G 4805	SUJ 2	0.95-1.10	0.15-0.35	Not more than 0.50	Not more than 0.25	Not more than 0.25	1.30 - 1.60	Not more than 0.08
	SUJ 3	0.95 - 1.10	0.40 - 0.70	0.90 - 1.15			0.90 - 1.20	Not more than 0.08
	SUJ 5	0.95 - 1.10	0.40 - 0.70	0.90 - 1.15			0.90 - 1.20	0.10 - 0.25
SAE J 404	S2100	0.98 - 1.10	0.15 - 0.35	0.25 - 0.45	Not more than 0.025	Not more than 0.025	1.30 - 1.60	Not more than 0.06

Remark) As for bearings which are induction hardened, carbon steel with a high carbon content of 0.55 to 0.65% is used in addition to those listed in this table.

Chemical composition of case carburizing bearing steel

Standard	Code	Chemical composition (%)							
		C	Si	Mn	P	S	Ni	Cr	Mo
JIS G 4104	SCr 415	0.13 - 1.18	0.15 - 0.35	0.60 - 0.85	Not more than 0.030	Not more than 0.030	-	0.90 - 1.20	-
	SCr 420	0.18 - 0.23	0.15 - 0.35	0.60 - 0.85			-	0.90 - 1.20	-
JIS G 4105	SCM 420	0.18 - 0.23	0.15 - 0.35	0.60 - 0.85	Not more than 0.030	Not more than 0.030	-	0.90 - 1.20	0.15 - 0.30
	SNCM 220	0.17 - 0.23	0.15 - 0.35	0.60 - 0.90	Not more than 0.030	Not more than 0.030	0.40 - 0.70	0.40 - 0.65	0.15 - 0.30
	SNCM 420	0.17 - 0.23	0.15 - 0.35	0.40 - 0.70			1.60 - 2.00	0.40 - 0.65	0.15 - 0.30
	SCNM 815	0.12 - 0.18	0.15 - 0.35	0.30 - 0.60			Not more than 0.030	Not more than 0.030	1.60 - 2.00
SAE J 404	5120	0.17 - 0.22	0.15 - 0.35	0.70 - 0.90	Not more than 0.030	Not more than 0.040	-	0.70 - 1.00	-
	8620	0.18 - 0.23	0.15 - 0.35	0.70 - 0.90	Not more than 0.030	Not more than 0.040	0.40 - 0.70	0.40 - 0.60	0.15 - 0.25
	4320	0.17 - 0.22	0.15 - 0.30	0.45 - 0.65	Not more than 0.025	Not more than 0.025	1.65 - 2.00	0.40 - 0.60	0.20 - 0.30

01 | Technical Introduction

Chemical composition of high speed steel for high temperature bearings

Standard	Code	Chemical composition (%)											
		C	Si	Mn	P	S	Cr	Mo	V	Ni	Cu	Co	W
AISI	M 50	0.77 - 0.85	Not more than 0.25	Not more than 0.35	Not more than 0.015	Not more than 0.015	3.75 - 4.25	4.00 - 4.50	0.90 - 1.10	Not more than 0.10	Not more than 0.10	Not more than 0.25	Not more than 0.25

Chemical composition of stainless steel

Standard	Code	Chemical composition (%)						
		C	Si	Mn	P	S	Cr	Mo
JIS G 4303	SUS 440 C	0.95 - 1.20	Not more than 1.00	Not more than 1.00	Not more than 0.040	Not more than 0.030	16.00 - 18.00	Not more than 0.75

Dimensions Table

02 | Deep Groove Ball Bearing

Deep groove ball bearing are the most popular and support radial and certain degree of axial load in both direction simultaneously. The following types of ball bearings are available:

1. Shielded / Sealed type

This simplifies the sealing. Greasing is not necessary because bearings are pre-lubricated.

The various types of seals are as follows:

a) ZZ (non-contact) Shield: This is good in applications that require small frictional torques and high speed with good resistance of dirt. These have very limited resistance of water.

b) 2RS/LLU (contact type) seal: This is good in applications that require large frictional torques. They have limitations in high speed applications due to the contact of seal. The grease sealing and direct and water resistance is very good.

2. With locating snap ring

These can be fit into housings easily as the locating snap ring facilitates axial positioning.

3. Extra-small ball bearings & Miniature ball bearings

The open type is widely used.

The standard cages used are pressed steel cages. Additionally copper alloy machined cages are also available.

DPI ball bearings are the most popular products. These are well known for their quality and performance. Our standard quality has made the ball bearing series very popular in most of the markets. For details on boundary dimensions and specifications please refer to the tables overleaf.

Deep Groove Ball Bearing



02 | Deep Groove Ball Bearing

Micro - Miniature deep groove ball bearing

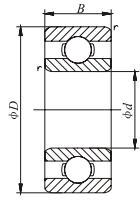

Open Type

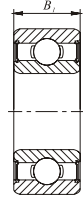

Shielded ZZ

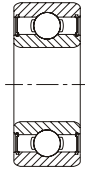

Contact seal type RS

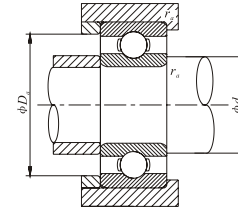

$d \ 2 \sim 9\text{mm}$

d	Main Dimension (mm)				Basic Load Rating (N)		Limit Speed (r/min)		Bearing No.	Mounting dimensions (mm)				Weight (g) Open	
	D	B	B_1	(r)	C_r	C_{or}	Grease Lubrication	Oil Lubrication		d_a Min	d_a Max	D_a Max	R_a Max		
2	4	1.2	2	0.5	104	37	83000	98000	672	2.5	2.6	3.5	0.05	0.06	
	5	1.5	2.3	0.08	171	51	74000	87000		682	2.8	2.9	4.2	0.08	0.13
	6	2.3	3	0.15	279	89	67000	79000		692	3.2	3.3	4.8	0.15	0.31
	7	2.8	3.5	0.15	380	125	62000	73000		602	3.2	3.7	5.8	0.15	0.54
3	6	2	2.5	0.08	242	94	60000	71000	673	3.6	4.1	5.4	0.08	0.2	
	7	2	3	0.1	390	130	58000	68000		683	3.9	4.1	5.8	0.1	0.33
	8	3	4	0.15	560	180	54000	63000		693	4.2	4.4	6.8	0.15	0.61
	9	3	5	0.15	635	219	50000	59000		603	4.2	5	7.8	0.15	0.92
	10	4	4	0.15	640	224	50000	58000		623	4.2	5.2	8.8	0.15	1.6
4	9	2.5	4	0.15	640	224	49000	57000	684	5	5.2	7.8	0.1	0.76	
	11	4	4	0.15	715	276	45000	52000		694	5.2	6.4	9.8	0.15	2.0
	12	4	4	0.2	970	360	43000	51000		604	5.6	6.6	10.4	0.2	2.3
	13	5	5	0.2	1310	490	42000	49000		624	5.6	6.2	11.4	0.2	3.5
	16	5	5	0.3	1760	680	37000	44000		634	6	7.6	14	0.3	5.1
5	8	2	2.5	0.08	217	91	49000	57000	675	5.6	6	7.4	0.08	0.32	
	11	3	5	0.15	715	282	43000	51000		685	6.2	6.8	9.8	0.15	1.1
	13	4	4	0.2	1080	430	40000	47000		695	6.6	6.9	11.4	0.2	2.4
	14	5	5	0.2	1330	505	39000	46000		605	6.6	7.4	12.4	0.2	3.6
	16	5	5	0.3	1760	680	37000	44000		625	7	7.6	14	0.3	4.8
	19	6	6	0.3	2340	885	34000	40000		635	7	9.5	17	0.3	8.0
	6	13	3.5	5	0.15	1080	440	39000		46000	686	7	7.2	11.6	0.15
15		5	5	0.2	1350	530	37000	44000	696	7.6		7.8	13.4	0.2	3.8
17		6	6	0.3	2190	865	35000	42000	606	8		8.6	15	0.3	6.0
19		6	6	0.3	2340	885	34000	40000	626	8		9.5	17	0.3	8.1
7	11	2.5	3	0.1	555	269	40000	47000	677	7.8	8.1	10.2	0.1	0.67	
	14	3.5	5	0.15	1170	505	37000	44000		687	8.2	8.7	12.8	0.15	2.1
	17	5	5	0.3	1610	715	35000	41000		697	9	10	15	0.3	5.2
	19	6	6	0.3	2240	910	34000	40000		607	9	10.4	17	0.3	8.0
	22	7	7	0.3	3350	1400	32000	37000		627	9	12.2	20	0.3	13.0
8	16	4	5	0.2	1610	715	35000	41000	688	9.6	10	14.4	0.2	3.1	
	19	6	6	0.3	1990	865	33000	39000		698	10	10.6	17	0.3	7.3
	22	7	7	0.3	3350	1400	32000	37000		608	10	12.2	20	0.3	12.0
	24	8	8	0.3	4000	1590	31000	36000		628	10	12.1	22	1.3	17.0
9	14	3	4.5	0.1	920	465	36000	42000	679	9.8	10.4	13.2	0.1	1.4	
	17	4	5	0.2	1720	820	33000	39000		689	10.6	10.7	15.4	0.2	3.2
	20	6	6	0.3	2480	1090	32000	38000		699	11	11.6	18	0.3	8.2
	24	7	7	0.3	3400	1480	31000	36000		609	11	13.1	22	0.3	14.0
	26	8	8	0.6	4550	1960	30000	35000		629	13	13.9	22	0.3	20.0

02 | Deep Groove Ball Bearing

Single Row Deep Groove Ball Bearing

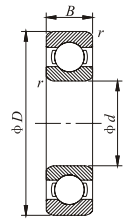

Open Type



Shielded Type (ZZ)



Contact seal type (RS)

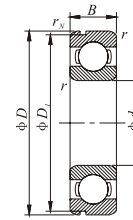

With snap groove

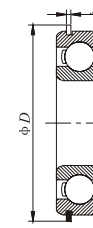
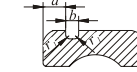

With snap ring

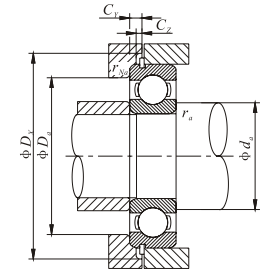

d 10 ~ 25mm

Main Dimension (mm)				Basic Load Rating (kN)		Limit Speed (r/min)		Bearing No.	Snap Groove dimensions (mm)					Stop Ring Dimensions (mm)		Mounting dimensions (mm)					Weight (kg) Max	
<i>d</i>	<i>D</i>	<i>B</i>	<i>r</i> (min)	<i>C_r</i>	<i>C_{0r}</i>	Grease Lubrication	Oil Lubrication		<i>a</i> Max	<i>b</i> Min	<i>D</i> ₁ Max	<i>r</i> ₀ Max	<i>r</i> ₃ Min	<i>D</i> ₂ Max	<i>f</i> Max	<i>d</i> ₃ Min	<i>D</i> ₄ Max	<i>r</i> ₅ Max	<i>D</i> ₅ Max	<i>C</i> ₆ Min		<i>C</i> ₇ Max
10	19	5	0.3	1.83	0.93	32000	38000	-	-	-	-	-	-	-	12	12.5	17	0.3	-	-	-	0.005
	22	6	0.3	2.70	1.27	30000	36000	1.05	0.8	20.8	0.2	0.3	24.8	0.7	12	13	20	0.3	25.5	1.5	0.7	0.009
	26	8	0.3	4.55	1.97	29000	34000	-	-	-	-	-	-	-	12	13.5	24	0.3	-	-	-	0.018
	30	9	0.6	5.10	2.39	25000	30000	2.06	1.35	28.17	0.4	0.5	34.7	1.12	14	16	26	0.6	35.5	2.9	1.2	0.032
	35	11	0.6	8.20	.50	23000	27000	2.06	1.35	33.17	0.4	0.5	39.7	1.12	14	17	31	0.6	40.5	2.9	1.2	0.053
12	21	5	0.3	1.92	1.04	29000	35000	-	-	-	-	-	-	-	14	14.5	19	0.3	-	-	-	0.006
	24	6	0.3	2.89	1.46	27000	32000	1.05	0.8	22.8	0.2	0.3	26.8	0.7	14	15	22	0.3	27.5	1.5	0.7	0.011
	28	7	0.3	5.10	2.39	26000	30000	-	-	-	-	-	-	-	14	-	26	0.3	-	-	-	0.019
	28	8	0.3	5.10	2.39	26000	30000	-	-	-	-	-	-	-	14	16	26	0.3	-	-	-	0.022
	32	10	0.6	6.10	2.75	22000	26000	2.06	1.35	30.15	0.4	0.5	36.7	1.12	16	17	28	0.6	37.5	2.9	1.2	0.037
	37	12	1	9.70	4.20	20000	24000	2.06	1.35	34.77	0.4	0.5	41.3	1.12	17	18.5	32	1	42	2.9	1.2	0.060
15	24	5	0.3	2.08	1.26	26000	31000	-	-	-	-	-	-	-	17	17.5	22	0.3	-	-	-	0.007
	28	7	0.3	3.65	2.00	24000	28000	1.3	0.95	26.7	0.25	0.3	30.8	0.85	17	17.5	26	0.3	31.5	1.9	0.9	0.016
	32	8	0.3	5.60	2.83	24000	26000	-	-	-	-	-	-	-	17	-	30	0.3	-	-	-	0.025
	32	9	0.3	5.60	2.83	22000	26000	2.06	1.35	30.15	0.4	0.3	36.7	1.12	17	19	30	0.3	37.5	2.9	1.2	0.030
	35	11	0.6	7.75	3.60	19000	23000	2.06	1.35	33.17	0.4	0.5	39.7	1.12	19	20	31	0.6	40.5	2.9	1.2	0.045
	42	13	1	11.40	5.45	17000	21000	2.06	1.35	39.75	0.4	0.5	46.3	1.12	20	23	37	1	47	2.9	1.2	0.082
17	26	5	0.3	2.23	1.46	24000	28000	-	-	-	-	-	-	-	19	19.5	24	0.3	-	-	-	0.008
	30	7	0.3	4.65	2.58	22000	26000	1.3	0.95	28.7	0.25	0.3	32.8	0.85	19	20	28	0.3	33.5	1.9	0.9	0.018
	35	8	0.3	6.80	3.35	20000	24000	-	-	-	-	-	-	-	19	-	33	0.3	-	-	0.9	0.032
	35	10	0.3	6.80	3.35	20000	24000	2.06	1.35	33.17	0.4	0.3	39.7	1.12	19	21	33	0.3	40.5	2.9	1.2	0.039
	40	12	0.6	9.60	4.60	18000	21000	2.06	1.35	38.1	0.4	0.5	44.6	1.12	21	23	36	0.6	45.5	2.9	1.2	0.066
	47	14	1	13.50	6.55	16000	19000	2.46	1.35	44.6	0.4	0.5	52.7	1.12	22	25	42	1	53.5	3.3	1.2	0.115
	62	17	1.1	22.70	10.80	14000	16000	-	-	-	-	-	-	-	23.5	-	55.5	1	-	-	-	0.270
20	32	7	0.3	4.00	2.47	21000	25000	1.3	0.95	30.7	0.25	0.3	34.8	0.85	22	22.5	30	0.3	35.5	1.9	0.9	0.019
	37	9	0.3	6.40	3.70	19000	23000	1.7	0.95	35.7	0.25	0.3	39.8	0.85	22	24	35	0.3	40.5	2.3	0.9	0.036
	42	8	0.3	7.90	4.50	18000	21000	-	-	-	-	-	-	-	22	-	40	0.3	-	-	-	0.051
	42	12	0.6	9.40	5.05	18000	21000	2.06	1.35	39.75	0.4	0.5	46.3	1.12	24	26	38	0.6	47	2.9	1.2	0.069
	47	12	0.6	9.40	5.05	16000	18000	2.46	1.35	44.6	0.4	0.5	52.7	1.12	24	26	42	1	53.5	3.3	1.2	0.106
	52	15	1.1	15.90	7.90	14000	17000	2.46	1.35	49.73	0.4	0.5	57.9	1.12	26.5	28.5	45.5	1	58.5	3.3	1.2	0.144
	72	19	1.1	28.50	13.90	12000	14000	-	-	-	-	-	-	-	26.5	-	65.5	1	-	-	-	0.400
22	44	12	0.6	9.40	5.05	17000	20000	2.06	1.35	41.75	0.4	0.5	48.3	1.12	26	26.5	40	0.6	49	2.9	1.2	0.074
	50	14	1	12.90	6.80	14000	17000	2.46	1.35	47.6	0.4	0.5	55.7	1.12	27	29.5	45	1	56.5	3.3	1.2	0.117
	56	16	1.1	18.40	9.25	13000	15000	2.46	1.35	53.6	0.4	0.5	61.7	1.12	28.5	31	49.5	1	62.5	3.3	1.2	0.176
25	37	7	0.3	4.30	2.95	18000	21000	1.3	0.95	65.7	0.25	0.3	39.8	0.85	27	28	35	0.3	40.5	1.9	0.9	0.022
	42	9	0.3	7.05	4.55	16000	19000	1.7	0.95	40.7	0.25	0.3	44.8	0.85	27	29	40	0.3	45.5	2.3	0.9	0.042
	47	8	0.3	5.10	15000	15000	-	-	-	-	-	-	-	-	27	-	45	0.3	-	-	-	0.060
	47	12	0.6	10.10	5.85	15000	18000	2.06	1.35	44.6	0.4	0.5	52.7	1.12	29	30	43	0.6	53.5	2.9	1.2	0.080

02 | Deep Groove Ball Bearing

Single Row Deep Groove Ball Bearing

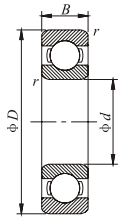

Open Type



Shielded Type (ZZ)



Contact seal type (RS)

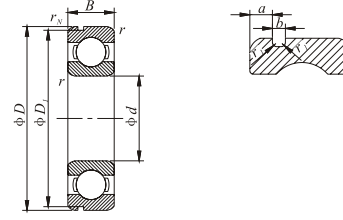

With snap groove

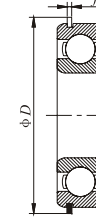

With snap ring

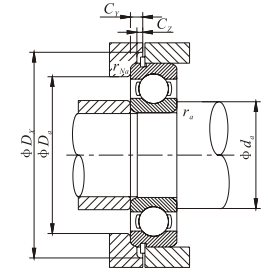

d 25 ~ 45mm

Main Dimension (mm)				Basic Load Rating (kN)		Limit Speed (r/min)		Bearing No.	Snap Groove dimensions (mm)					Stop Ring Dimensions (mm)		Mounting dimensions (mm)						Weight (kg) Max	
d	D	B	r (min)	C ₁	C _{0r}	Grease Lubrication	Oil Lubrication		a Max	b Min	D ₁ Max	r ₀ Max	r _β Min	D ₂ Max	f Max	d _a Min	D _a Max	r _a Max	D _x Max	C _y Min	C _z Max		
25	52	15	1	14.10	7.85	13900	15000	6205 6305 6405	2.46	1.35	49.73	0.4	0.5	57.9	1.12	30	32	47	1	58.5	3.3	1.2	0.128
	62	17	1.1	21.20	10.90	12000	14000		3.28	1.9	59.61	0.6	0.5	67.7	1.7	31.5	35	55.5	1	68.5	4.6	1.7	0.232
	80	21	1.35	34.50	17.50	10000	12000		-	-	-	-	-	-	-	33	-	72	1.5	-	-	-	0.530
28	52	12	0.6	12.50	7.40	14000	16000	60/28 62/28 63/28	2.06	1.35	49.73	0.4	0.5	57.9	1.12	32	34	48	0.6	58.5	2.9	1.2	0.098
	58	16	1	17.90	9.75	12000	14000		2.46	1.35	55.6	0.4	0.5	63.7	1.12	33	35.5	53	1	64.5	3.3	1.2	0.171
	68	18	1.1	26.70	14.00	11000	13000		3.28	1.9	64.82	0.6	0.5	74.6	1.7	34.5	38.5	61.5	1	76	4.6	1.7	0.284
30	42	7	0.3	4.70	3.65	15000	18000	6806 6906 16006 6006 6206	1.3	0.95	40.7	0.25	0.3	44.8	0.85	32	33	40	0.3	45.5	1.9	0.9	0.026
	47	9	0.3	7.25	5.00	14000	17000		1.7	0.95	45.7	0.25	0.3	49.8	0.85	32	34	45	0.3	50.5	2.3	0.9	0.048
	55	9	0.3	11.20	7.35	13000	15000		-	-	-	-	-	-	-	32	-	53	0.3	-	-	-	0.091
	55	13	1	13.20	8.30	13000	15000		2.08	1.35	52.6	0.4	0.5	60.7	1.12	35	37	50	1	61.5	2.9	1.2	0.116
	62	16	1	19.50	11.30	11000	13000		3.28	1.9	59.61	0.6	0.5	67.7	1.7	35	39	57	1	68.5	4.6	1.7	0.199
30	72	19	1.1	26.70	15.00	10000	12000	6306 6406	3.28	1.9	68.81	0.6	0.5	78.6	1.7	36.5	43	65.5	1	80	4.6	1.7	0.360
	90	23	1.5	43.50	23.90	8800	10000		-	-	-	-	-	-	-	38	-	82	1.5	-	-	-	0.735
32	58	13	1	11.80	8.05	12000	15000	60/32 62/32 63/32	2.08	1.35	55.6	0.4	0.5	63.7	1.12	37	39	53	1	64.5	2.9	1.2	0.129
	65	17	1	20.70	11.60	11000	12000		3.28	1.9	62.6	0.6	0.5	70.7	1.7	37	40	60	1	71.5	4.6	1.7	0.226
	75	20	1.1	29.80	16.90	9500	11000		3.28	1.9	71.83	0.6	0.5	81.6	1.7	38.5	43.5	68.5	1	83	4.6	1.7	0.382
35	47	7	0.3	4.90	4.05	13000	16000	6807 6907 16007 6007 6207 6307 6407	1.3	0.95	45.7	0.25	0.3	49.8	0.85	37	38	45	0.3	50.5	1.9	0.9	0.029
	55	10	0.6	9.55	6.85	12000	15000		1.7	0.95	53.7	0.25	0.5	57.8	0.85	39	40	51	0.6	58.5	2.3	0.9	0.074
	62	9	0.3	11.70	8.20	12000	14000		-	-	-	-	-	-	-	37	-	60	0.3	-	-	-	0.110
	62	14	1	16.00	10.30	12000	14000		2.08	1.9	59.61	0.6	0.5	67.7	1.7	40	42	57	1	68.5	3.4	1.7	0.155
	72	17	1.1	25.70	15.30	9800	11000		3.28	1.9	68.81	0.6	0.5	78.6	1.7	41.5	45	65.5	1	80	4.6	1.7	0.288
	80	21	1.5	33.50	19.10	8800	10000		3.28	1.9	76.81	0.6	0.5	86.6	1.7	43	47	72	1.5	88	4.6	1.7	0.457
	100	25	1.5	55.00	31.00	7800	9100		-	-	-	-	-	-	-	43	-	92	1.5	-	-	-	0.952
40	52	7	0.3	5.10	4.40	12000	14000	6808 6908 16008 6008 6208 6308 6408	1.3	0.95	50.7	0.25	0.3	54.8	0.85	42	43	50	0.3	55.5	1.9	0.9	0.033
	62	12	0.6	12.20	8.90	11000	13000		1.7	0.95	60.7	0.25	0.5	64.8	0.85	44	45	58	0.6	65.5	2.3	0.9	0.110
	68	9	0.3	12.60	9.65	10000	12000		1.7	-	-	-	-	-	-	42	-	66	0.3	-	-	-	0.125
	68	15	1	16.80	11.50	10000	12000		2.49	1.9	64.82	0.6	0.5	74.6	1.7	45	47	63	1	76	3.8	1.7	0.190
	80	18	1.1	29.10	17.80	8700	10000		3.28	1.9	76.81	0.6	0.5	86.6	1.7	46.5	51	73.5	1	88	4.6	1.7	0.366
	90	23	1.5	40.50	24.00	7800	9200		3.28	2.7	86.79	0.6	0.5	96.5	2.46	48	54	82	1.5	98	5.4	2.5	0.630
	110	27	2	63.50	36.50	7000	8200		-	-	-	-	-	-	-	49	-	101	2	-	-	-	1.230
45	58	7	0.3	5.35	4.95	11000	12000	6809 6909 16009 6009 6209 6309 6409	1.3	0.95	56.7	0.25	0.3	60.8	0.85	47	48	56	0.3	61.5	1.9	0.9	0.038
	68	12	0.6	13.10	10.40	9800	12000		1.7	0.95	66.7	0.25	0.5	70.8	0.85	49	51	64	0.6	72	2.3	0.9	0.128
	75	10	0.6	12.90	10.50	9200	11000		-	-	-	-	-	-	-	49	-	71	0.6	-	-	-	0.171
	75	16	1	21.00	15.10	9200	11000		2.49	1.9	71.83	0.6	0.5	81.6	1.7	50	52.5	70	1	83	3.8	1.7	0.237
	85	19	1.1	32.50	20.40	7800	9200		3.28	1.9	81.81	0.6	0.5	91.6	1.7	51.5	55.5	78.5	1	93	4.6	1.7	0.398
	100	25	1.5	53.00	32.00	7000	8200		3.28	2.7	96.8	0.6	0.5	106.5	2.46	53	61.5	92	1.5	108	5.4	2.5	0.814
	120	29	2	77.00	45.00	6300	7400		-	-	-	-	-	-	-	54	-	111	2	-	-	-	1.530

02 | Deep Groove Ball Bearing

Single Row Deep Groove Ball Bearing

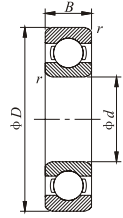

Open Type



Shielded Type (ZZ)



Contact seal type (RS)

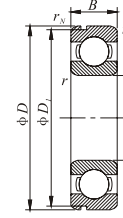

With snap groove

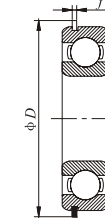
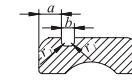

With snap ring

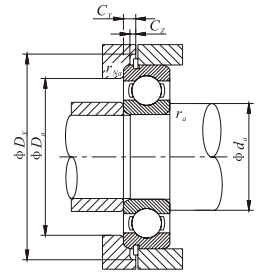

d 50 ~ 70mm

Main Dimension (mm)				Basic Load Rating (kN)		Limit Speed (r/min)		Bearing No.	Snap Groove dimensions (mm)					Stop Ring Dimensions (mm)		Mounting dimensions (mm)						Weight (kg) Max
<i>d</i>	<i>D</i>	<i>B</i>	<i>r</i> (min)	<i>C_r</i>	<i>C_{0r}</i>	Grease Lubrication	Oil Lubrication		<i>a</i> Max	<i>b</i> Min	<i>D₁</i> Max	<i>r₀</i> Max	<i>r₁</i> Min	<i>D₂</i> Max	<i>f</i> Max	<i>d_a</i> Min	<i>D_a</i> Max	<i>r_a</i> Max	<i>D_x</i> Max	<i>C_y</i> Min	<i>C_z</i> Max	
50	65	7	0.3	6.60	6.10	9600	11000	1.3	0.95	63.7	0.25	0.3	67.8	0.85	52	54	63	0.3	68.5	1.9	0.9	0.050
	72	12	0.6	13.40	11.20	9000	11000	1.7	0.95	70.7	0.25	0.5	74.8	0.85	54	55.5	68	0.6	76	2.3	0.9	0.135
	80	10	0.6	13.20	11.30	8500	10000	-	-	-	-	-	-	-	54	-	76	0.6	-	-	-	0.175
	80	16	1	21.80	16.60	8500	10000	2.49	1.9	76.81	0.6	0.5	86.6	1.7	55	57.5	75	1	88	3.8	1.7	0.261
	90	20	1.1	35.00	23.20	7100	8300	3.28	2.7	86.79	0.6	0.5	96.5	2.46	56.5	60	83.5	1	98	5.4	2.5	0.454
	110	27	2	62.00	38.50	6400	7500	3.28	2.7	106.81	0.6	0.5	116.6	2.46	59	68.5	101	2	118	5.4	2.5	1.060
	130	30	2.1	83.00	49.50	5700	6700	-	-	-	-	-	-	-	61	-	119	2	-	-	-	1.880
55	72	9	0.3	8.80	8.10	870	10000	1.7	0.95	70.7	0.25	0.3	74.8	0.85	57	59	70	0.3	76	2.3	0.9	0.083
	80	13	1	16.00	13.30	8200	9600	2.1	1.3	77.9	0.4	0.5	84.4	0.12	60	61.5	75	1	86	2.9	1.2	0.180
	90	11	0.6	18.60	15.30	7700	9000	-	-	-	-	-	-	-	59	-	86	0.6	-	-	-	0.258
	90	18	1.1	28.30	21.20	7700	9000	2.87	2.7	86.79	0.6	0.5	96.5	2.46	61.5	64	83.5	1	98	5	2.5	0.388
	100	21	1.5	43.50	29.20	6400	7600	3.28	2.7	96.8	0.6	0.5	106.5	2.46	63	67	92	1.5	108	5.4	2.5	0.601
	120	29	2	71.50	45.00	5800	6800	4.06	3.1	115.21	0.6	0.5	129.7	2.82	64	74	111	2	131.5	6.5	2.9	1.370
	140	33	2.1	89.00	54.00	5200	6100	-	-	-	-	-	-	-	66	-	129	2	-	-	-	2.290
60	78	10	0.3	11.50	10.60	8000	9400	1.7	1.3	76.2	0.4	0.3	82.7	1.12	62	64.5	76	0.3	84	2.5	1.2	0.106
	85	13	1	16.40	14.30	7600	8900	2.1	1.3	82.9	0.4	0.5	89.4	1.12	65	66.5	80	1	91	2.9	1.2	0.193
	95	11	0.6	20.00	17.50	7000	8300	-	-	-	-	-	-	-	64	-	91	0.6	-	-	-	0.283
	95	18	1.1	29.50	23.20	7000	8300	2.87	2.7	91.82	0.6	0.5	101.6	2.46	66.5	69	88.5	1	103	5	2.5	0.414
	110	22	1.5	52.50	36.00	6000	7000	3.28	2.7	106.81	0.6	0.5	116.6	2.46	68	75	102	1.5	118	5.4	2.5	0.783
	130	31	2.1	82.00	52.00	5400	6300	4.06	3.1	125.22	0.6	0.5	139.7	2.82	71	80.5	119	2	141.5	6.5	2.9	1.730
	150	35	2.1	102.00	64.50	4800	5700	-	-	-	-	-	-	-	71	-	139	2	-	-	-	2.770
65	85	10	0.6	11.60	11.00	7400	8700	1.7	1.3	82.9	0.4	0.5	89.4	1.12	69	70	81	0.6	91	2.5	1.2	0.128
	90	13	1	17.40	16.10	7000	8200	2.1	1.3	87.9	0.4	0.5	94.4	1.12	70	71.5	85	1	96	2.9	1.2	0.206
	100	11	0.6	20.50	18.70	6500	7700	-	-	-	-	-	-	-	69	-	96	0.6	-	-	-	0.307
	100	18	1.1	30.50	25.20	6500	7700	2.87	2.7	96.8	0.6	0.5	106.5	2.46	71.5	74	93.5	1	108	5	2.5	0.421
	120	23	1.5	57.50	40.00	5500	6500	4.06	3.1	115.21	0.6	0.5	129.7	2.82	73	80.5	112	1.5	131.5	6.5	2.9	0.990
	140	33	2.1	92.50	60.00	4900	5800	4.9	3.1	135.23	0.6	0.5	149.7	2.82	76	86	129	2	152	7.3	2.9	2.080
	160	37	2.1	111.00	72.50	4400	5200	-	-	-	-	-	-	-	76	-	149	2	-	-	-	3.300
70	90	10	0.6	12.10	11.90	6900	8100	1.7	1.3	87.9	0.4	0.5	94.4	1.12	74	75.5	86	0.6	96	2.5	1.2	0.137
	100	16	1	23.70	21.20	6500	7700	2.5	1.3	97.9	0.4	0.5	104.4	1.12	75	77.5	95	1	106	3.3	1.2	0.334
	110	13	0.6	24.40	22.60	6100	7100	-	-	-	-	-	-	-	74	-	106	0.6	-	-	-	0.441
	110	20	1.1	38.00	31.00	6100	7100	2.87	2.7	106.81	0.6	0.5	116.6	2.46	76.5	80.5	103.5	1	118	5	2.5	0.604
	125	24	1.5	62.00	44.00	5100	6000	4.06	3.1	120.22	0.6	0.5	134.7	2.82	78	85	117	1.5	136.5	6.5	2.9	1.070
	150	35	2.1	104.00	68.00	4600	5400	4.9	3.1	145.24	0.6	0.5	159.7	2.82	81	92.5	139	2	162	7.3	2.9	2.520
	180	42	3	128.00	89.50	4100	4800	-	-	-	-	-	-	-	83	-	167	2.5	-	-	-	4.830

02 | Deep Groove Ball Bearing

Single Row Deep Groove Ball Bearing

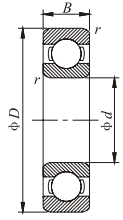

Open Type



Shielded Type (ZZ)



Contact seal type (RS)

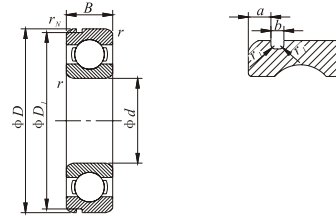

With snap groove

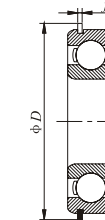

With snap ring

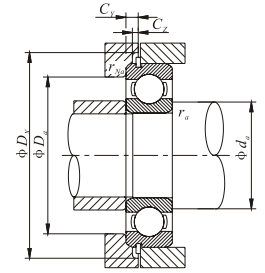

d 75~ 100mm

Main Dimension (mm)				Basic Load Rating (kN)		Limit Speed (r/min)		Bearing No.	Snap Groove dimensions (mm)					Stop Ring Dimensions (mm)		Mounting dimensions (mm)						Weight (kg) Max	
d	D	B	r (min)	C _r	C _{0r}	Grease Lubrication	Oil Lubrication		a Max	b Min	D ₁ Max	r ₀ Max	r ₁ Min	D ₂ Max	f Max	d _a Min	D _a Max	r _a Max	D _x Max	C _y Min	C _z Max		
75	95	10	0.6	12.50	12.90	6400	7600	6815 6915 16015 6015 6215 6315 6415	1.7	1.3	92.9	0.4	0.5	99.4	1.12	79	80	91	0.6	101	2.5	1.2	0.145
	105	16	1	24.40	22.60	6100	7200		2.5	1.3	102.6	0.4	0.5	110.7	1.12	80	82.5	100	1	112	3.3	1.2	0.353
	115	13	0.6	25.00	24.00	5700	6700		-	-	-	-	-	-	-	79	-	111	0.6	-	-	-	0.464
	115	20	1.1	39.50	33.50	5700	6700		2.87	2.7	111.81	0.6	0.5	121.6	2.46	81.5	85.5	108.5	1	123	5	2.5	0.649
	130	25	1.5	66.00	46.50	4800	5600		4.06	3.1	125.22	0.6	0.5	139.7	2.82	83	90.5	122	1.5	141.5	6.5	2.9	1.180
	160	37	2.1	113.00	77.00	4300	5000		4.9	3.1	155.22	0.6	0.5	169.7	2.82	86	99	149	2	172	7.3	2.9	3.020
	190	45	3	138.00	99.00	3800	4500		-	-	-	-	-	-	-	88	-	177	2.5	-	-	-	5.720
80	100	10	0.6	12.70	13.30	6000	7100	6816 6916 16016 6016 6216 6316 6416	1.7	1.3	97.9	0.4	0.5	104.4	1.12	84	85	96	0.6	106	2.5	1.2	0.154
	110	16	1	24.90	24.00	5700	6700		2.5	1.3	107.6	0.4	0.5	115.7	1.12	85	88	105	1	117	3.3	1.2	0.373
	125	14	0.6	25.40	25.10	5300	6200		-	-	-	-	-	-	-	84	-	121	0.6	-	-	-	0.597
	125	22	1.1	47.50	40.00	5300	6200		2.87	3.1	120.22	0.6	0.5	134.7	2.82	86.5	91.5	118.5	1	136.5	5.3	2.9	0.854
	140	26	2	72.50	53.00	4500	5300		4.9	3.1	135.23	0.6	0.5	149.7	2.82	89	95.5	131	2	152	7.3	2.9	1.400
	170	39	2.1	123.00	86.50	4000	4700		5.69	3.5	163.65	0.6	0.5	182.9	3.1	91	105	159	2	185	8.4	3.1	3.590
	200	48	3	164.00	125.00	3600	4200		-	-	-	-	-	-	-	93	-	187	2.5	-	-	-	6.760
85	110	13	1	18.70	19.00	5700	6700	6817 6917 16017 6017 6217 6317	2.1	1.3	107.6	0.4	0.5	115.7	1.12	90	91	105	1	117	2.9	1.2	0.270
	120	18	1.1	32.00	29.60	5400	6300		3.3	1.3	117.6	0.4	0.5	125.7	1.12	91.5	94	113.5	1	127	4.1	1.2	0.536
	130	14	0.6	25.90	26.20	5000	5900		-	-	-	-	-	-	-	89	-	126	0.06	-	-	-	0.626
	130	22	1.1	49.50	43.00	5000	5900		2.87	3.1	125.22	0.6	0.5	139.7	2.82	91.5	97	123.5	1	141.5	5.3	2.9	0.890
	150	28	2	83.50	64.00	4200	5000		4.9	3.1	145.24	0.6	0.5	159.7	2.82	94	103	141	2	162	7.3	2.9	1.790
	180	41	3	133.00	97.00	3800	4500		5.69	3.5	173.66	0.6	0.5	192.9	3.1	98	112	167	2.5	195	8.4	3.1	4.230
90	115	13	1	19.00	19.70	5400	6300	6818 6918 16018 6018 6218 6318	2.1	1.3	112.6	0.4	0.5	120.7	1.12	95	96	110	1	122	2.9	1.2	0.285
	125	18	1.1	33.00	31.50	5100	6000		3.3	1.3	122.6	0.4	0.5	130.7	1.12	96.5	99	118.5	1	132	4.1	1.2	0.554
	140	16	1	33.50	33.50	4700	5600		-	-	-	-	-	-	-	95	-	135	1	-	-	-	0.848
	140	24	1.5	58.00	49.50	4700	5600		3.71	3.1	135.23	0.6	0.5	149.7	2.82	98	102	132	1.5	152	6.1	2.9	1.020
	160	30	2	96.00	71.50	4000	4700		4.9	3.1	155.22	0.6	0.5	169.7	2.82	99	109	151	2	172	7.3	2.9	2.150
	190	43	3	143.00	107.00	3600	4200		5.69	3.5	183.64	0.6	0.5	202.9	3.1	103	118	177	2.5	205	8.4	3.1	4.910
95	120	13	1	19.30	20.50	5000	5900	6819 6919 16019 6019 6219 6319	2.1	1.3	117.6	0.4	0.5	125.7	1.12	100	101	115	1	127	2.9	1.2	0.300
	130	18	1.1	33.50	33.50	4800	5700		3.3	1.3	127.6	0.4	0.5	135.7	1.12	101.5	104	123.5	1	137	4.1	1.2	0.579
	145	16	1	34.50	35.00	4500	5300		-	-	-	-	-	-	-	100	-	140	1	-	-	-	0.885
	145	24	1.5	60.50	54.00	4500	5300		3.71	3.1	140.23	0.6	0.5	154.7	2.82	103	109	137	1.5	157	6.1	2.9	1.080
	170	32	2.1	109.00	82.00	3700	4400		5.69	3.5	163.65	0.6	0.5	182.9	3.1	106	116	159	2	185	8.4	3.1	2.620
	200	45	3	153.00	119.00	3300	3900		5.69	3.5	193.65	0.6	0.5	212.9	3.1	108	125	187	2.5	215	8.4	3.1	5.670
100	125	13	1	19.60	21.20	4800	5600	6820 6920 16020 6020 6220 6320	2.1	1.3	122.6	0.4	0.5	130.7	1.12	105	106	120	1	132	2.9	1.2	0.313
	140	20	1.1	41.00	39.50	4500	5300		3.3	1.9	137.6	0.6	0.5	145.7	1.7	106.5	110	133.5	1	147	4.7	1.7	0.785
	150	16	1	35.00	36.50	4200	5000		-	-	-	-	-	-	-	105	-	145	1	-	-	-	0.910
	150	24	1.5	60.00	54.00	4200	5000		3.71	3.1	145.24	0.6	0.5	159.7	2.82	108	110	142	1.5	162	6.1	2.9	1.150
	180	34	2.1	122.00	93.00	3500	4200		5.69	3.5	173.66	0.6	0.5	192.9	3.1	111	122	169	2	195	8.4	3.1	3.140
	215	47	3	173.00	141.00	3200	3700		-	-	-	-	-	-	-	113	133	202	2.5	-	-	-	7.000

02 | Deep Groove Ball Bearing

Single Row Deep Groove Ball Bearing

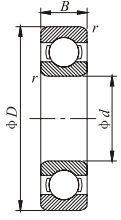

Open Type



Shielded Type (ZZ)



Contact seal type (RS)

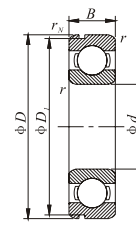

With snap groove

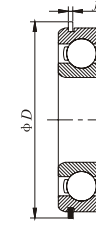
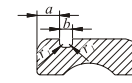

With snap ring

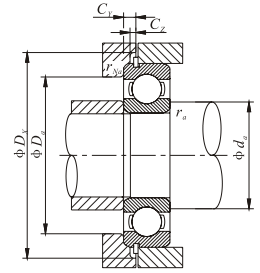

d 105~ 150mm

Main Dimension (mm)				Basic Load Rating (kN)		Limit Speed (r/min)		Bearing No.	Snap Groove dimensions (mm)					Stop Ring Dimensions (mm)		Mounting dimensions (mm)					Weight (kg)		
<i>d</i>	<i>D</i>	<i>B</i>	<i>r</i> (min)	<i>C_r</i>	<i>C_{0r}</i>	Grease Lubrication	Oil Lubrication		<i>a</i> Max	<i>b</i> Min	<i>D</i> ₁ Max	<i>r</i> ₀ Max	<i>r</i> ₁ Min	<i>D</i> ₂ Max	<i>f</i> Max	<i>d</i> _a Min	<i>D</i> _a Max	<i>r</i> _a Max	<i>D</i> _x Max	<i>C</i> _y Min		<i>C</i> _z Max	Max
105	130	13	1	19.80	22.00	4600	5400	9821 6921 16021 6021 6221 6321	2.1	1.3	127.6	0.4	0.5	135.7	1.12	110	-	125	1	137	2.9	1.2	0.330
	145	20	1.1	42.50	42.00	4300	5100		3.3	1.9	142.6	0.6	0.5	150.7	1.7	111.5	115	138.5	1	152	4.7	1.7	0.816
	160	18	1	52.00	50.50	4000	4700		-	-	-	-	-	-	-	110	-	155	1	-	-	-	1.200
	160	26	2	72.50	65.50	4000	4700		3.71	3.1	155.22	0.6	0.5	169.7	2.82	114	119	151	2	172	6.1	2.9	1.590
	190	36	2.1	133.00	105.00	3400	4000		5.69	3.5	183.64	0.6	0.5	202.9	3.1	116	125	179	2	205	8.4	3.1	3.700
	225	49	3	184.00	153.00	3000	3600		-	-	-	-	-	-	-	118	134	212	2.5	-	-	-	8.050
110	140	16	1	24.90	28.20	4300	5100	6822 6922 16022 6022 6222 6322	2.5	1.9	137.6	0.6	0.5	145.7	1.7	115	-	135	1	147	3.9	1.7	0.515
	150	20	1.1	43.50	44.50	4100	4800		3.3	1.9	147.6	0.6	0.5	155.7	1.7	116.5	120	143.5	1	157	4.7	1.7	0.849
	170	19	1	57.50	56.50	3800	4500		-	-	-	-	-	-	-	115	-	165	-	-	-	-	1.460
	170	28	2	82.00	73.00	3800	4500		3.71	3.5	163.55	0.6	0.5	182.9	3.1	119	126	161	2	185	6.4	3.1	1.960
	200	38	2.1	144.00	117.00	3200	3800		5.69	3.5	193.65	0.6	0.5	212.9	3.1	121	132	189	2	215	8.4	3.1	4.360
	240	50	3	205.00	179.00	2900	3400		-	-	-	-	-	-	-	123	149	227	2.5	-	-	-	9.540
120	150	16	1	28.90	33.00	4000	4700	6824 6924 16024 6024 6224 6324	2.5	1.9	147.6	0.6	0.5	155.7	1.7	125	-	145	1	157	3.9	1.7	0.555
	165	22	1.1	53.00	54.00	3800	4400		3.7	1.9	161.8	0.6	0.5	171.5	1.7	126.5	-	158.5	1	173	5.1	1.7	1.150
	180	19	1	63.00	63.50	3500	4100		-	-	-	-	-	-	-	125	-	175	1	-	-	-	1.560
	180	28	2	85.00	79.50	3500	4100		3.71	3.5	173.66	0.6	0.5	192.9	3.1	129	136	171	2	195	6.4	3.1	2.070
	215	40	2.1	155.00	131.00	2900	3400		-	-	-	-	-	-	-	131	143	204	2	-	-	-	5.150
	260	55	3	207.00	185.00	2600	3100		-	-	-	-	-	-	-	133	-	247	2.5	-	-	-	12.40
130	165	18	1.1	37.0	41.0	3700	4300	6826 6926 16026 6026 6226 6326	3.3	1.9	161.8	0.6	0.5	171.5	1.7	136.5	-	158.5	1	173	4.7	1.7	0.800
	180	24	1.5	65.0	67.5	3500	4100		3.7	1.9	176.8	0.6	0.5	186.5	1.7	138	-	172	1.5	188	5.1	1.7	1.520
	200	22	1.1	80.0	79.5	3200	3800		-	-	-	-	-	-	-	136.5	-	193.5	1	-	-	-	2.310
	200	33	2	106.0	101.0	3200	3800		5.69	3.5	193.65	0.6	0.5	212.9	3.1	139	148	191	2	215	8.4	3.1	3.160
	230	40	3	167.0	146.0	2700	3100		-	-	-	-	-	-	-	143	-	217	2.5	-	-	-	5.820
	280	58	4	229.0	214.0	2400	2800		-	-	-	-	-	-	-	146	-	264	3	-	-	-	15.30
140	175	18	1.1	38.5	44.5	3400	4000	6828 6928 16028 6028 6228 6328	3.3	1.9	171.8	0.6	0.5	181.5	1.7	146.5	-	168.5	1	183	4.7	1.7	0.850
	190	24	1.5	66.5	71.5	3200	3800		3.7	1.9	186.8	0.6	0.5	196.5	1.7	148	-	182	1.5	198	5.1	1.7	1.620
	210	24	1.5	66.5	71.5	3200	3500		-	-	-	-	-	-	-	146.5	-	203.5	1	-	-	-	2.450
	210	33	2	110.0	109.0	3000	3500		-	-	-	-	-	-	-	149	158	201	2	-	-	-	3.350
	250	42	3	166.0	150.0	2500	2900		-	-	-	-	-	-	-	153	-	237	2.5	-	-	-	7.570
	300	62	4	253.0	246.0	2200	2600		-	-	-	-	-	-	-	156	-	284	3	-	-	-	18.50
150	190	20	1.1	47.5	55.0	3100	3700	6830 6930 16030 6030 6230 6330	3.3	1.9	186.8	0.6	0.5	196.5	1.7	156.5	-	183.5	1	198	4.7	1.7	1.160
	210	28	2	85.0	90.5	3000	3500		-	-	-	-	-	-	-	159	-	201	2	-	-	-	2.470
	225	24	1.1	96.5	101.0	2800	3200		-	-	-	-	-	-	-	156.5	-	218.5	1	-	-	-	3.070
	225	35	2.1	126.0	126.0	2800	3200		-	-	-	-	-	-	-	161	169	214	2	-	-	-	4.080
	270	45	3	176.0	168.0	2300	2700		-	-	-	-	-	-	-	163	-	257	2.5	-	-	-	9.410
	320	65	4	274.0	284.0	2100	2400		-	-	-	-	-	-	-	166	-	304	3	-	-	-	22.00

02 | Deep Groove Ball Bearing

Single Row Deep Groove Ball Bearing

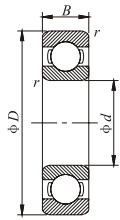

Open Type



Shielded Type (ZZ)



Contact Seal type (RS)

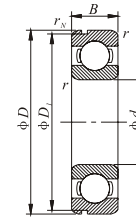

With snap groove

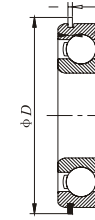
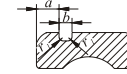

With snap ring

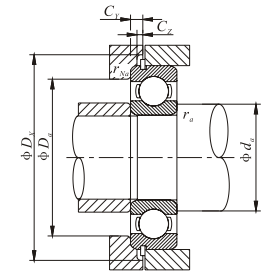

d 160~170mm

Main Dimension (mm)				Basic Load Rating (kN)		Limit Speed (r/min)		Bearing No.	Snap Groove dimensions (mm)					Stop Ring Dimensions (mm)		Mounting dimensions (mm)					Weight (kg) Max	
d	D	B	r (min)	C _r	C _{0r}	Grease Lubrication	Oil Lubrication		a Max	b Min	D ₁ Max	r ₀ Max	r _β Min	D ₂ Max	f Max	d _a Min	D _a Max	r _a Max	D _x Max	C _y Min		C _z Max
160	200	20	1.1	48.5	57.0	2900	3400	3.3	1.9	196.8	0.6	0.5	206.5	1.7	166.5	-	193.5	1	208	4.7	1.7	1.230
	220	28	2	87.0	96.0	2800	3300	-	-	-	-	-	-	-	169	-	211	2	-	-	-	2.610
	240	25	1.5	99.0	108.0	2600	3000	-	-	-	-	-	-	-	168	-	232	1.5	-	-	-	3.640
	240	38	2.1	143.0	144.0	2600	3000	-	-	-	-	-	-	-	171	183	229	2	-	-	-	5.050
	290	48	3	185.0	186.0	2100	2500	-	-	-	-	-	-	-	173	-	277	2.5	-	-	-	11.70
	340	68	4	278.0	286.0	1900	2300	-	-	-	-	-	-	-	176	-	324	3	-	-	-	26.00
170	215	22	1.1	60.0	70.5	2700	3200	-	-	-	-	-	-	-	176.5	-	208.5	1	-	-	-	1.630
	230	28	2	86.0	95.5	2600	3100	-	-	-	-	-	-	-	179	-	221	2	-	-	-	2.740
	260	28	1.5	119.0	128.0	2400	2800	-	-	-	-	-	-	-	178	-	252	1.5	-	-	-	4.930
	260	42	2.1	168.0	172.0	2400	2800	-	-	-	-	-	-	-	181	-	249	2	-	-	-	6.760
	310	52	4	212.0	223.0	2000	2400	-	-	-	-	-	-	-	186	-	294	3	-	-	-	14.50
	360	72	4	325.0	355.0	1800	2100	-	-	-	-	-	-	-	186	-	344	3	-	-	-	30.70

02 | Deep Groove Ball Bearing

Stainless Steel Ball Bearing

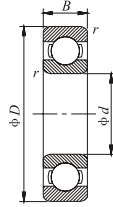

Boundary dimensions (mm)				Basic load ratings (N)		Speed ratings (rpm)		Bearing No.	Abutment and filter dimensions (mm)				Weight (kg)
<i>d</i>	<i>D</i>	<i>B</i>	<i>(r)</i>	<i>Dynamic (Cr)</i>	<i>Static (Cor)</i>	<i>Grease</i>	<i>Oil</i>		<i>Ds min</i>	<i>Ds max</i>	<i>Dh max</i>	<i>R max</i>	
7	19	6	0.3	2240	910	39000	33000	SS 607	9	-	17	0.3	0.008
8	22	7	0.3	3350	1400	36000	31000	SS 608	10	-	20	0.3	0.012
9	24	7	0.3	3400	1450	33000	29000	SS 609	11	-	22	0.3	0.014
10	26	8	0.3	4580	1980	28000	20000	SS 6000	12	13.5	24	0.3	0.019
12	28	8	0.3	5100	2380	26000	19000	SS 6001	14	16	26	0.3	0.022
15	32	9	0.3	5600	2840	24000	18000	SS 6002	17	19	30	0.3	0.031
17	35	10	0.3	6800	3350	22000	17000	SS 6003	19	21	33	0.3	0.04
20	42	12	0.6	9400	5050	19000	15000	SS 6004	24	26	38	0.6	0.071
25	47	12	0.6	10100	5850	17000	13000	SS 6005	29	30.5	43	0.6	0.084
30	55	13	1	13200	8300	14000	10000	SS 6006	35	37	50	1	0.11
35	62	14	1	16000	10300	12000	9000	SS 6007	40	42	57	1	0.162
40	68	15	1	16800	11500	11000	8500	SS 6008	45	47	63	1	0.199
45	75	16	1	21000	15100	10000	8000	SS 6009	50	52.5	70	1	0.23
50	80	16	1	21800	16600	9000	7000	SS 6010	55	57.5	75	1	0.272
55	90	18	1.1	28300	21200	7700	8300	SS 6011	62	64	83	1	0.388
60	95	18	1.1	29500	23200	7000	8300	SS 6012	67	69	88	1	0.414
65	100	18	1.1	30500	25200	6500	7700	SS 6013	72	73	93	1	0.421
70	110	20	1.1	38000	31000	6100	7100	SS 6014	77	80.5	103	1	0.604
75	115	20	1.1	39500	33500	5700	6700	SS 6015	82	85.5	108	1	0.649

02 | Deep Groove Ball Bearing

Stainless Steel Ball Bearing

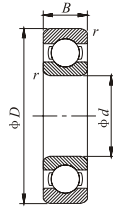

Boundary dimensions (mm)				Basic load ratings (N)		Speed ratings (rpm)		Bearing No.	Abutment and filter dimensions (mm)				Weight (kg)
<i>d</i>	<i>D</i>	<i>B</i>	<i>r</i> (min)	Dynamic (<i>Cr</i>)	Static (<i>Cor</i>)	Grease	Oil		<i>Ds min</i>	<i>Ds max</i>	<i>Dh max</i>	<i>R max</i>	
6	19	6	0.3	2340	885	39000	33000	SS 626	8.0	-	17	0.3	0.008
7	22	7	0.3	3350	1400	36000	31000	SS 627	9.0	-	20	0.3	0.014
9	26	8	0.3	4550	1960	31000	27000	SS 629	11.0	-	24	0.3	0.019
10	30	9	0.6	5100	2380	26000	19000	SS 6200	14.0	16.0	26	0.6	0.032
12	32	10	0.6	6100	2750	24000	18000	SS 6201	16.0	17.5	28	0.6	0.035
15	35	11	0.6	7750	3600	22000	17000	SS 6202	19.0	20.5	31	0.6	0.045
17	40	12	0.6	9600	4600	20000	16000	SS 6203	21.0	23.0	36	0.6	0.064
20	47	14	1.0	12800	6650	18000	14000	SS 6204	24.0	28.0	42	1.0	0.103
25	52	15	1.0	14000	7880	16000	12000	SS 6205	30.0	32.0	47	1.0	0.127
30	62	16	1.0	19500	11500	13000	9500	SS 6206	35.0	39.0	57	1.0	0.200
35	72	17	1.1	25500	15200	11000	8500	SS 6207	41.5	45.0	65.5	1.1	0.298
40	80	18	1.1	29100	17800	10000	8000	SS 6208	46.5	51.0	73.5	1.1	0.368
45	85	19	1.1	32500	20400	9000	7000	SS 6209	51.5	55.5	78.5	1.1	0.416
50	90	20	1.1	35000	23200	8500	6700	SS 6210	56.5	60.0	83.5	1.1	0.463
55	100	21	1.5	43500	29200	6400	7600	SS 6211	63.0	67.0	92	1.5	0.601
60	110	22	1.5	52500	36000	6000	7000	SS 6212	68.0	75.0	102	1.5	0.783

02 | Deep Groove Ball Bearing

Stainless Steel Ball Bearing

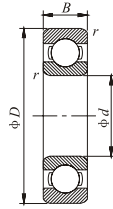

Boundary dimensions (mm)				Basic load ratings (N)		Speed ratings (rpm)		Bearing No.	Abutment and filter dimensions (mm)				Weight (kg)
<i>d</i>	<i>D</i>	<i>B</i>	<i>(r)</i>	<i>Dynamic (Cr)</i>	<i>Static (Cor)</i>	<i>Grease</i>	<i>Oil</i>		<i>Ds min</i>	<i>Ds max</i>	<i>Dh max</i>	<i>R max</i>	
10	35	11	0.6	8200	3500	23000	27000	SS 6300	14.0	17.0	31.0	0.6	0.053
12	37	12	1.0	9700	4200	20000	24000	SS 6301	18.0	18.5	31.0	1.0	0.060
15	42	13	1.0	11400	5450	17000	21000	SS 6302	21.0	23.0	36.0	1.0	0.082
17	47	14	1.0	13500	6550	16000	19000	SS 6303	23.0	25.0	41.0	1.0	0.115
20	52	15	1.0	15900	7900	14000	17000	SS 6304	27.0	28.5	45.0	1.0	0.144
25	62	17	1.0	21200	10900	12000	14000	SS 6305	32.0	35.0	55.0	1.0	0.232
30	72	19	1.0	26700	15000	10000	12000	SS 6306	37.0	43.0	65.0	1.0	0.360
35	80	21	1.5	33500	19100	8800	10000	SS 6307	43.5	47.0	71.5	1.5	0.457
40	90	23	1.5	40500	24000	7800	9200	SS 6308	48.5	54.0	81.5	1.5	0.630
45	100	25	1.5	53000	32000	7000	8200	SS 6309	53.5	61.5	91.5	1.5	0.814
50	110	27	2.0	62000	38500	6400	7500	SS 6310	60.0	68.5	100.0	2.0	1.070
40	80	18	1.1	29100	17800	10000	8000	SS 6208	46.5	51.0	73.5	1.1	0.368
45	85	19	1.1	32500	20400	9000	7000	SS 6209	51.5	55.5	78.5	1.1	0.416
50	90	20	1.1	35000	23200	8500	6700	SS 6210	56.5	60.0	83.5	1.1	0.463
55	100	21	1.5	43500	29200	6400	7600	SS 6211	63.0	67.0	92	1.5	0.601
60	110	22	1.5	52500	36000	6000	7000	SS 6212	68.0	75.0	102	1.5	0.783

02 | Deep Groove Ball Bearing

Ball Bearing Series

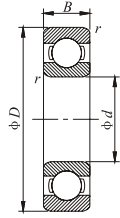

Open Type



Shielded Type (ZZ)



Contact Seal type (2RS)

Boundary dimensions (mm)			Basic load ratings (N)		Speed ratings (rpm)		Bearing No.	Weight (kg)
d	D	B	Dynamic (Cr)	Static (Cor)	Grease	Oil		
12.700	33.338	9.525	5162	3026	21000	28500	RLS 4	0.037
1/2	1-5/16	3/8						
15.875	39.688	11.112	7387	4361	18000	24000	RLS 5	0.059
5/8	1-9/16	7/16						
19.050	47.625	14.288	10547	6542	15000	21000	RLS 6	0.109
3/4	1-7/8	9/16						
22.225	50.800	14.288	10725	6542	14300	19500	RLS 7	0.116
7/8	2	9/16						
25.400	57.150	15.875	13795	8900	12700	17000	RLS 8	0.169
1	2-1/4	5/8						
28.575	63.500	15.875	14997	10013	11700	15500	RLS 9	0.220
1-1/8	2-1/2	5/8						
31.750	69.850	17.463	20470	13929	10600	14400	RLS 10	0.276
1-1/4	2-3/4	11/16						
34.925	76.200	17.463	23051	15842	9800	13200	RLS 11	0.333
1-3/8	3	11/16						
38.100	82.550	19.050	25810	17889	9000	12200	RLS 12	0.418
1-1/2	3-1/4	3/4						
41.275	88.900	19.050	28658	20070	8400	11330	RLS 13	0.481
1-5/8	3-1/2	3/4						
44.45	95.250	20.638	31595	22339	7800	10600	RLS 14	0.594
1-3/4	3-3/4	13/16						
47.625	101.600	20.638	37380	27857	7200	9800	RLS 15	0.708
1-7/8	4	13/16						

Ball Bearing Series

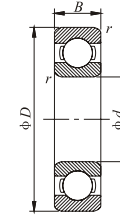

Open Type



Shielded Type (ZZ)



Contact Seal type (2RS)

Boundary dimension (mm)			Basic load ratings (N)		Speed ratings (rpm)		Bearing No.	Weight (kg)
d	D	B	Dynamic (Cr)	Static (Cor)	Grease	Oil		
12.700	41.275	15.875	9034	5607	18500	25000	RMS 4	0.096
1/2	1-5/8	5/8						
15.875	46.038	15.875	9345	5607	16500	22000	RMS 5	0.117
5/8	1-13/16	5/8						
19.050	50.800	17.463	12193	7788	14700	20000	RMS 6	0.156
3/4	2	11/16						
22.225	57.150	17.463	14196	9123	13300	18000	RMS 7	0.197
7/8	2-1/4	11/16						
25.400	63.500	19.050	16332	10547	12200	16500	RMS 8	0.262
1	2-1/2	3/4						
28.575	71.438	20.638	22695	15842	10800	14500	RMS 9	0.347
1-1/8	2-13/16	13/16						
31.750	79.375	22.225	27902	19536	9800	13200	RMS 10	0.476
1-1/4	3-1/8	7/8						
34.925	88.900	22.225	33598	23852	8800	11900	RMS 11	0.608
1-3/8	3-1/2	7/8						
38.100	95.250	23.813	36490	26211	8200	11000	RMS 12	0.753
1-1/2	3-3/4	15/16						
41.275	101.600	23.813	40495	30038	7700	10300	RMS 13	0.857
1-5/8	4	15/16						
44.45	107.950	26.998	43254	31195	7100	9600	RMS 14	1.061
1-3/4	4-1/4	1-1/16						
47.625	114.300	26.998	51175	38715	6600	8900	RMS 15	1.220
1-7/8	4-1/2	1-1/16						

03 | Angular Contact Ball Bearing

Angular Contact Ball Bearing



Angular contact ball bearings are ideal for applications which require accuracy and speed. These kinds of bearings are required to carry a combined load. The following different types of angular contact bearings are available:

1. Shield / Sealed type.

The standard contact angles are 15 degrees (C), 30 degrees (A) and 40 degrees (B). Smaller contact angles are suitable for higher speed applications. Large contact angles provide better axial resistance. These bearings are also available as matched pair bearings where they are matched as follows:

- a) Back-to-Back (DB): These are arranged so that the distance between the load centers is long and hence this arrangement will sustain larger moment loads.
- b) Face-to-Face (DF): These are arranged so that the distance between the load centers is short and hence ability to carry moment loads is smaller.
- c) Tandem Arrangement: This arrangement is useful for applications that require high axial load.

2. Double Row Contact Bearings:

These consist of two single row angular contact ball bearings matched back-to-back with integrated inner and outer rings.

3. Four Point Contact Bearings:

These have a contact angle of 35 degrees. The inner ring is divided into 2 pieces. These are very specialized bearings.

The standard cages used are pressed steel cages. Additionally copper alloy machined cages are also available.

For details on boundary dimensions and specifications please refer to the tables overleaf

Radial Thrust Ball bearing

Angular contact ball bearings can bear radial loading and axial load simultaneously, and single row angular contact ball bearings can only bear single direction axial load, therefore, they are often used in pairs. When used in pairs, the paired angular contact ball bearings with preset gap are most convenient. The contact angles between steel balls and the inner race/outer race are 15°, 25° and 40°. The larger its contact angle is the higher axial load it can bear. Smaller contact angle is good for high speed rotation. Generally, high precision and high speed bearings often adopt the contact angle of 15°.

1. Single Row angular contact bearing

The type of bearings has contact angle, so they are suited to bear single direction axial load, or combined load.

Structurally, they generate axial thrust load after bearing radial loading, so two bearings shall be used in pairs, or more than two back to back duplexes. The rigidity of single row angular contact ball bearings can be improved through pretension. Therefore, they are applied to the principal axes of high rotation precision machine tools, etc.

The contact angles of standard products include 15° (code C), 25° (code AC) and 40° (code AC). The retainers of bearings with 15° and 25° contact angles are often made of bakelite. The materials of the retainers of 40° contact angle bearings include copper, nylon, steel sheet etc.

In addition, where the retainer structures of the same bearing specifications are different and the number of balls varies, the load ratings are also different from the values in dimension table.

For 15° (code C) and 25° code (AC) angular contact ball bearings, high precision above P4 grade can be achieved.

These products are especially suited for the principal axes of high speed and high machine tools and spinning frames.

2. Paired duplex angular contact ball bearing

The structures and features of paired duplex angular contact ball bearings are shown in Table 1.

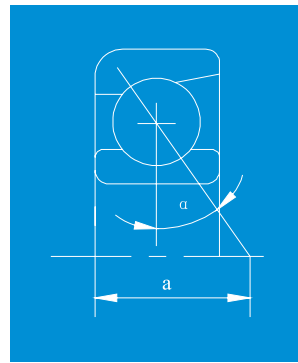

Table 1 the structures and features of paired duplex angular contact ball bearing

Standard	Structures	Features
	Back to back paired duplex E.g: 7209 CDB	Can bear radial loading and axial load from two from directions. The application point distance a_0 is large, are applicable where the torque load is large.
	Back to back paired duplex E.g: 7209 BDF	Can bear radial loading and axial load from two from directions. Compared with back to back paired duplex, the application point distance is smaller, so the torque load capacity is no good.
	Parallel paired duplex E.g: 7209 CDT	Can bear radial loading and axial load from one directions. Bearing axial load with two bearings, so used where the single direction load is large.

Note: The dimension table does not provide the value of the application point a_0 . Please contact technical center of DPI if required.

3. Double row angular contact ball bearing

The inner and outer races of the back to back duplex bearings are combined into one structure, which can bear two directional axial loads, and the torque load capacity is large. They can be used as restrained end bearings.

Pressed retainers or nylon retainers are often used.

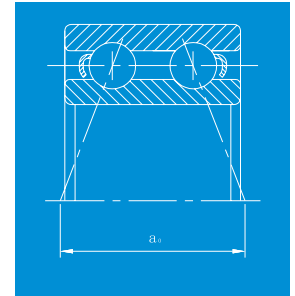

4. Four point contact ball bearing

Inner race is divided into two, and one bearing bears axial from two directions.

Contact angle is 35°, axial load capacity is high, suited to bear net axial load, or resultant load whose axial load is high.

Copper alloy lathe retainers are often used.

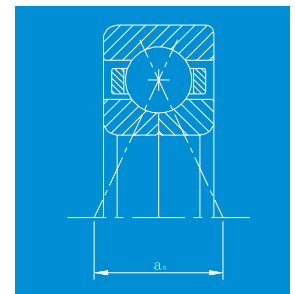

03 | Angular Contact Ball Bearing

Single row angular contact ball bearing

Static equivalent load $P_0 = X_0 F_r + Y_0 F_a$

Nominal contact angle	Single row, series combination		Back combination, face combination	
	X_0	Y_0	X_0	Y_0
15°	0.5	0.46	1	0.92
25°	0.5	0.38	1	0.76
40°	0.5	0.26	1	0.52

Note: When the single row or series combination $P_0 > 0.5F_r + Y_0 F_a$, $P_0 = F_r$

Static equivalent load $P = X F_r + Y F_a$

Nominal contact angle	$\frac{i f_0 F_a^*}{C_{or}}$	e	Single row, series combination				Back combination, face combination			
			$F_a/F_r < e$		$F_a/F_r > e$		$F_a/F_r < e$		$F_a/F_r > e$	
			X	Y	X	Y	X	Y	X	Y
15°	0.178	0.38	1	0	0.44	1.47	1	1.65	0.72	2.39
	0.357	0.40	1	0	0.44	1.40	1	1.57	0.72	2.28
	0.714	0.43	1	0	0.44	1.30	1	1.46	0.72	2.11
	1.070	0.46	1	0	0.44	1.23	1	1.38	0.72	2.00
	1.430	0.47	1	0	0.44	1.19	1	1.34	0.72	1.93
	2.140	0.50	1	0	0.44	1.12	1	1.26	0.72	1.82
	3.570	0.55	1	0	0.44	1.02	1	1.14	0.72	1.66
	5.350	0.56	1	0	0.44	1.00	1	1.12	0.72	1.63
25°	-	0.68	1	0	0.41	0.87	1	0.92	0.67	1.41
45°	-	1.14	1	0	0.38	0.57	1	0.55	0.57	0.93

Note: * i = 2 in back combination and series combination, i = 1 in series combination.

Double row angular contact ball bearing

$P_0 = X F_r + Y F_a$

$F_a/F_r < e$		$F_a/F_r > e$		e
X	Y	X	Y	
1	0.92	0.67	1.41	0.68

Static equivalent load $P = F_r + 76 F_a$

Static equivalent load $P_a = F_a$

Static equivalent load $P_{ca} = F_a$

03 | Angular Contact Ball Bearing

Angular Contact Ball Bearing

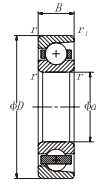

Single Row

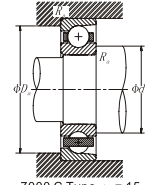

7000 C Type $\alpha = 15^\circ$
7000 A C Type $\alpha = 25^\circ$
7000 B Type $\alpha = 40^\circ$

d 10 ~ 20mm

d	Main Dimension (mm)					Basic Load Rating (kN)		Limit Speed (r/min)		Bearing No.	Weight (Single row) (kg)
	D	B	2B	r (min)	r (max)	C _r	C _{0r}	Grease Lubrication	Oil Lubrication		
	Grease Lubrication		Oil Lubrication								
10	26	8	16	0.30	0.15	5.02	2.31	29000	39000	7000C	0.023
	26	8	16	0.30	0.15	4.80	2.17	29000	39000	7000AC	0.023
	30	9	18	0.60	0.30	5.88	3.06	28000	37000	7200C	0.029
	30	9	18	0.60	0.30	5.63	2.87	28000	37000	7200AC	0.029
	30	9	18	0.60	0.30	5.00	2.52	24000	32000	7200B	0.029
	35	11	22	0.60	0.30	10.09	4.91	26000	34000	7300C	0.039
	35	11	22	0.60	0.30	9.65	4.61	26000	34000	7300AC	0.040
	35	11	22	0.60	0.30	8.80	4.10	22000	29000	7300B	0.041
12	28	8	16	0.30	0.15	5.45	2.74	26000	35000	7001C	0.025
	28	8	16	0.30	0.15	5.21	2.57	26000	35000	7001AC	0.025
	32	10	20	0.60	0.30	7.72	4.02	25000	33000	7201C	0.034
	32	10	20	0.60	0.30	7.38	3.77	25000	33000	7201AC	0.035
	32	10	20	0.60	0.30	6.60	3.35	21000	28000	7201B	0.036
	37	12	24	1.00	0.60	12.09	5.86	23000	30000	7301C	0.043
	37	12	24	1.00	0.60	11.56	5.49	23000	30000	7301AC	0.044
	37	12	24	1.00	0.60	10.50	4.95	19000	26000	7301B	0.045
15	32	9	18	0.30	0.15	6.26	3.51	23000	31000	7002C	0.035
	32	9	18	0.30	0.15	5.99	3.30	23000	31000	7002AC	0.035
	35	11	22	0.60	0.30	9.77	5.24	22000	29000	7202C	0.045
	35	11	22	0.60	0.30	9.34	4.92	22000	29000	7202AC	0.046
	35	11	22	0.60	0.30	8.35	4.35	18000	25000	7202B	0.047
	42	13	26	1.00	0.60	14.57	8.03	19000	26000	7302C	0.055
	42	13	26	1.00	0.60	13.94	7.54	19000	26000	7302AC	0.056
	42	13	26	1.00	0.60	12.50	6.65	17000	22000	7302B	0.057
17	35	10	20	0.30	0.15	7.72	4.29	21000	28000	7003C	0.045
	35	10	20	0.30	0.15	7.38	4.03	21000	28000	7003AC	0.046
	40	12	24	0.60	0.30	12.95	7.36	19000	26000	7203C	0.062
	40	12	24	0.60	0.30	12.39	6.91	19000	26000	7203AC	0.064
	40	12	24	0.60	0.30	11.00	6.10	17000	22000	7203B	0.066
	47	14	28	1.00	0.6	17.16	9.65	18000	24000	7303C	0.105
	47	14	28	1.00	0.60	16.41	9.05	18000	24000	7303AC	0.107
	47	14	28	1.00	0.60	14.80	8.00	15000	20000	7303b	0.109
20	42	12	24	0.60	0.30	10.47	6.25	19000	25000	7004C	0.079
	42	12	24	0.60	0.30	10.01	5.86	19000	25000	7004AC	0.080
	47	14	28	1.00	0.60	15.65	9.37	17000	23000	7204C	0.098
	47	14	28	1.00	0.60	14.97	8.79	17000	23000	7204AC	0.100
	47	14	28	1.00	0.60	13.30	7.70	15000	20000	7204B	0.102
	52	15	30	1.10	0.60	20.19	11.60	16000	21000	7304C	0.140
	52	15	30	1.10	0.60	19.31	10.88	16000	21000	7304AC	0.138
	52	15	30	1.10	0.60	17.30	9.65	13000	18000	7304B	0.140

Angular Contact Ball Bearing

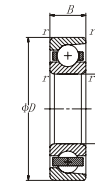

Single Row

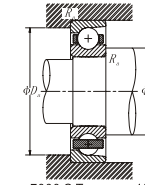

7000 C Type $\alpha = 15^\circ$
7000 A C Type $\alpha = 25^\circ$
7000 B Type $\alpha = 40^\circ$

d 25 ~ 45mm

d	Main Dimension (mm)					Basic Load Rating (kN)		Limit Speed (r/min)		Bearing No.	Weight (Single row) (kg)
	D	B	2B	r (min)	r (max)	C _r	C _{0r}	Grease Lubrication	Oil Lubrication		
	Grease Lubrication		Oil Lubrication								
25	47	12	24	0.60	0.30	11.55	7.64	16000	21000	7005C	0.091
	47	12	24	0.60	0.30	11.05	7.17	16000	21000	7005AC	0.093
	52	15	30	1.00	0.60	17.49	11.49	14000	19000	7205C	0.122
	52	15	30	1.00	0.60	16.72	10.78	14000	19000	7205AC	0.125
	52	15	30	1.00	0.60	14.80	9.40	12000	16000	7205B	0.129
	62	14	34	1.10	0.60	28.50	17.62	13000	17000	7305C	0.227
	62	14	34	1.10	0.60	27.25	16.54	13000	17000	7305AC	0.230
	62	14	34	1.10	0.60	24.40	14.60	11000	15000	7305B	0.234
30	55	13	26	1.00	0.60	15.00	10.54	13000	18000	7006C	0.133
	55	13	26	1.00	0.60	14.35	9.89	13000	18000	7006AC	0.135
	62	16	32	1.00	0.60	24.29	16.51	12000	16000	7206C	0.190
	62	16	32	1.00	0.60	23.23	15.49	12000	16000	7206AC	0.193
	62	16	32	1.00	0.60	20.50	13.50	11000	14000	7206B	0.197
	72	19	38	1.10	0.60	36.16	24.87	11000	15000	7306C	0.339
	72	19	38	1.10	0.60	34.58	23.34	11000	15000	7306AC	0.345
	72	19	38	1.10	0.60	31.00	20.50	9600	13000	7306B	0.352
35	62	14	28	1.00	0.60	18.89	14.05	12000	16000	7007C	0.160
	62	14	28	1.00	0.60	18.07	13.19	12000	16000	7007AC	0.180
	72	17	34	1.10	0.60	32.06	22.42	11000	14000	7207C	0.275
	72	17	34	1.10	0.60	30.66	21.04	11000	14000	7207AC	0.281
	72	17	34	1.10	0.60	27.10	18.40	9300	12000	7207B	0.287
	80	21	42	1.50	1.00	43.18	29.33	9800	13000	7307C	0.455
	80	21	42	1.50	1.00	41.29	27.52	9800	13000	7307AC	0.462
	80	21	42	1.50	1.00	36.50	24.20	8400	11000	7307B	0.469
40	68	15	30	1.00	0.60	20.29	16.28	10000	14000	7008C	0.219
	68	15	30	1.00	0.60	19.41	15.28	10000	14000	7008AC	0.222
	80	18	36	1.10	0.60	38.32	28.00	9600	13000	7208C	0.340
	80	18	36	1.10	0.60	36.65	26.27	9600	13000	7208AC	0.355
	80	18	36	1.10	0.60	32.00	23.00	8300	11000	7208B	0.375
	90	23	46	1.50	1.00	34.54	25.65	8600	12000	7308C	0.610
	90	23	46	1.50	1.00	33.04	24.07	8600	12000	7308AC	0.625
	90	23	46	1.50	1.00	45.00	30.50	7400	9900	7308B	0.636
45	75	16	32	1.00	0.60	24.07	19.74	9500	13000	7009C	0.270
	75	16	32	1.00	0.60	23.02	18.52	9500	13000	7009AC	0.282
	85	19	38	1.10	0.60	42.64	32.01	8700	12000	7209C	0.395
	85	19	38	1.10	0.60	40.78	30.04	8700	12000	7209AC	0.404
	85	19	38	1.10	0.60	36.00	26.20	7400	9900	7209B	0.410
	100	25	50	1.50	1.00	68.54	48.52	7800	10000	7309C	0.810
	100	25	50	1.50	1.00	65.55	45.52	7800	10000	7309AC	0.837
	100	25	50	1.50	1.00	58.50	40.00	6600	8900	7309B	0.854

03 | Angular Contact Ball Bearing

Angular Contact Ball Bearing

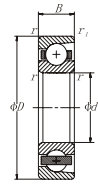

Single Row

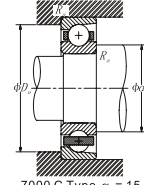

7000 C Type $\alpha = 15^\circ$
7000 A C Type $\alpha = 25^\circ$
7000 B Type $\alpha = 40^\circ$

d 50 ~ 70mm

d	Main Dimension (mm)					Basic Load Rating (kN)		Limit Speed (r/min)		Bearing No.	Weight (Single row) (kg)	
	D	B	2B	r (min)	r (max)	C _r	C _{0r}	Grease Lubrication	Oil Lubrication			
50	80	16	32	1.00	0.60	25.58	22.42	8600	11000	7010C	0.300	
	80	16	32	1.00	0.60	24.47	21.04	8600	11000	7010AC	0.306	
	90	20	40	1.10	0.60	44.80	35.13	7900	10000	7210C	0.448	
	90	20	40	1.10	0.60	42.84	32.97	7900	10000	7210AC	0.457	
	90	20	40	1.10	0.60	37.50	58.60	6700	9000	7210B	0.466	
	110	27	54	2.00	1.00	79.88	58.00	7100	9400	7310C	1.070	
	110	27	54	2.00	1.00	76.39	54.42	7100	9400	7310AC	1.090	
	110	27	54	2.00	1.00	68.00	48.00	6000	8100	7310B	1.110	
	55	90	18	36	1.10	0.60	33.46	29.33	7900	11000	7011C	0.210
		90	18	36	1.10	0.60	32.00	27.52	7900	11000	7011AC	0.214
100		21	42	1.50	1.00	55.05	44.06	7100	9500	7211C	0.589	
100		21	42	1.50	1.00	52.65	41.34	7100	9500	7211AC	0.600	
100		21	42	1.50	1.00	46.50	36.00	6100	8200	7211B	0.612	
120		29	58	2.00	1.00	92.83	68.59	6400	8600	7311C	1.370	
120		29	58	2.00	1.00	88.78	64.36	6400	8600	7311AC	1.390	
120		29	58	2.00	1.00	79.00	56.50	5500	7300	7311B	1.420	
60		95	18	36	1.10	0.60	34.54	31.34	7200	9600	7012C	0.467
		95	18	36	1.10	0.60	33.04	29.41	7200	9600	7012AC	0.478
	110	22	44	1.50	1.00	66.38	54.65	6600	8800	7212C	0.750	
	110	22	44	1.50	1.00	63.49	51.28	6600	8800	7212AC	0.765	
	110	22	44	1.50	1.00	56.00	44.50	5700	7600	7212B	0.780	
	130	31	62	2.10	1.10	105.78	79.75	5900	7900	7312C	1.700	
	130	31	62	2.10	1.10	101.17	74.83	5900	7900	7312AC	1.740	
	130	31	62	2.10	1.10	90.00	66.00	5100	6800	7312B	1.770	
	65	100	18	36	1.10	0.60	36.16	35.13	6700	9000	7013C	0.495
		100	18	36	1.10	0.60	34.58	32.97	6700	9000	7013AC	0.509
120		23	46	1.50	1.00	76.10	64.69	6100	8100	7213B	0.981	
120		23	46	1.50	1.00	74.65	62.93	6100	8100	7213AC	0.962	
120		23	46	1.50	1.00	63.50	52.50	5200	7000	7213B	0.981	
140		33	66	2.10	1.10	119.82	91.46	5500	7300	7313C	2.090	
140		33	66	2.10	1.10	114.59	85.81	5500	7300	7313AC	2.110	
140		33	66	2.10	1.10	102.00	75.50	4700	6300	7313B	2.150	
70		110	20	40	1.10	0.60	45.88	44.06	6200	8300	7014C	0.690
		110	20	40	1.10	0.60	43.87	41.34	6200	8300	7014AC	0.705
	125	24	48	1.50	1.00	82.58	70.83	5700	7600	7214C	1.070	
	125	24	48	1.50	1.00	78.97	66.45	5700	7600	7214AC	1.090	
	125	24	48	1.50	1.00	69.00	58.00	4900	6500	7214B	1.110	
	150	35	70	2.10	1.10	134.93	104.29	5100	6800	7314C	2.510	
	150	35	70	2.10	1.10	129.04	97.85	5100	6800	7314AC	2.560	
	150	35	70	2.10	1.10	114.00	86.00	4400	5800	7314B	2.610	

Angular Contact Ball Bearing

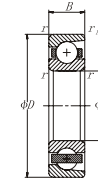

Single Row

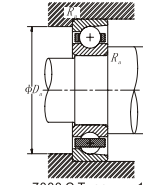

7000 C Type $\alpha = 15^\circ$
7000 A C Type $\alpha = 25^\circ$
7000 B Type $\alpha = 40^\circ$

d 75 ~ 95mm

d	Main Dimension (mm)					Basic Load Rating (kN)		Limit Speed (r/min)		Bearing No.	Weight (Single row) (kg)	
	D	B	2B	r (min)	r (max)	C _r	C _{0r}	Grease Lubrication	Oil Lubrication			
75	115	20	40	1.10	0.60	46.96	46.29	5800	7800	7015C	0.730	
	115	20	40	1.10	0.60	44.91	43.43	5800	7800	7015AC	0.745	
	130	25	50	1.50	1.00	85.27	76.40	5300	7100	7215C	1.150	
	130	25	50	1.50	1.00	81.56	71.69	5300	7100	7215AC	1.170	
	130	25	50	1.50	1.00	71.50	62.00	4500	6000	7215B	1.190	
	160	37	74	2.10	1.10	146.80	118.23	4800	6300	731C	3.020	
	160	37	74	2.10	1.10	140.40	110.93	4800	6300	7315AC	3.070	
	160	37	74	2.10	1.10	125.00	97.50	4100	5400	7315B	3.130	
	80	125	22	44	1.10	0.60	57.75	56.33	5500	7300	7016C	0.980
		125	22	44	1.10	0.60	55.23	52.85	5500	7300	7016AC	0.994
140		26	52	2.00	1.00	96.07	84.77	5000	6600	7216C	1.360	
140		26	52	2.00	1.00	91.88	79.54	5000	6600	7216AC	1.390	
140		26	52	2.00	1.00	91.88	79.54	4300	5700	7216B	1.420	
170		39	78	2.10	1.10	158.67	132.73	4500	5900	7316C	3.590	
170		39	78	2.10	1.10	151.75	124.54	4500	5900	7316AC	3.650	
170		39	78	2.10	1.10	135.00	109.00	3800	5100	7316B	3.720	
85		130	22	44	1.10	0.60	58.83	59.67	5100	6900	7017C	1.020
		130	22	44	1.1	0.60	56.26	55.99	5100	6900	7017AC	1.040
	150	28	56	2.00	1.00	107.40	98.71	4700	6200	7217C	1.760	
	150	28	56	2.00	1.00	102.72	92.62	4700	6200	7217AC	1.780	
	150	28	56	2.00	1.00	90.00	80.50	4000	5300	7217B	1.820	
	180	41	82	3.00	1.10	171.63	148.34	4200	5600	7317C	4.260	
	180	41	82	3.00	1.10	164.14	139.19	4200	5600	7317AC	4.340	
	180	41	82	3.00	1.10	146.00	122.00	3600	4800	7317B	4.430	
	90	140	24	48	1.50	1.00	70.16	70.83	4900	6500	7018C	1.310
		140	24	48	1.50	1.00	67.10	66.45	4900	6500	7018AC	1.350
160		30	60	2.00	1.00	127.37	114.88	4400	5900	7218C	2.140	
160		30	60	2.00	1.00	121.82	107.79	4400	5900	7218AC	2.180	
160		30	60	2.00	1.00	121.82	107.79	4400	5900	7218B	2.220	
190		43	86	3.00	1.10	184.58	163.96	4000	5300	7318C	4.970	
190		43	86	3.00	1.10	176.53	153.84	4000	5300	7318AC	5.060	
190		43	86	3.00	1.10	156.00	135.00	3400	4500	7318B	5.160	
95		145	24	48	1.50	1.00	72.32	74.73	4600	6100	7019C	1.370
		145	24	48	1.50	1.00	69.17	70.12	4600	6100	7019AC	1.410
	170	32	64	2.00	1.10	143.56	131.61	4100	5500	7219C	2.620	
	170	32	64	2.00	1.10	137.30	123.49	4100	5500	7219AC	2.670	
	170	32	64	2.00	1.10	121.00	107.00	3500	4700	7219AC	2.720	
	200	45	90	3.00	1.10	197.53	180.69	3700	5000	7319C	5.770	
	200	45	90	3.00	1.10	188.92	169.54	3700	5000	7319AC	5.890	
	200	45	90	3.00	1.10	167.00	149.00	3200	4200	7319B	6.000	

03 | Angular Contact Ball Bearing

Angular Contact Ball Bearing

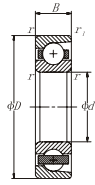

Single Row

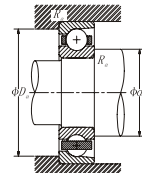

7000 C Type $\alpha = 15^\circ$
 7000 A C Type $\alpha = 25^\circ$
 7000 B Type $\alpha = 40^\circ$

d100mm

d	Main Dimension (mm)					Basic Load Rating (kN)		Limit Speed (r/min)		Bearing No.	Weight (Single row) (kg)
	D	B	2B	r (min)	r (max)	C _r	C _{0r}	Grease Lubrication	Oil Lubrication		
100	150	24	48	1.50	1.00	73.94	78.63	4400	5800	7020C	1.400
	150	24	48	1.50	1.00	70.72	73.78	4400	5800	7020AC	1.470
	180	34	68	2.10	1.10	155.44	140.54	3900	5200	7220C	3.120
	180	34	68	2.10	1.10	148.66	131.86	3900	5200	7220AC	3.260
	180	34	68	2.10	1.10	130.00	114.00	3400	4500	7220B	3.400
	215	47	94	3.00	1.10	223.44	215.26	3500	4700	7320C	7.050
	215	47	94	3.00	1.10	213.69	201.98	3500	4700	7320AC	7.180
	215	47	94	3.00	1.10	190.00	178.00	3000	4000	7320B	7.320

03 | Angular Contact Ball Bearing

Double Row Angular Contact Ball Bearing

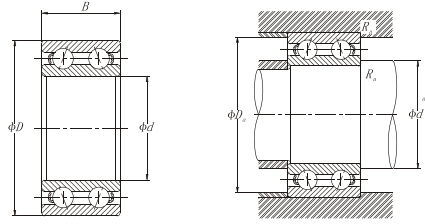

d 25 ~ 100mm

Main Dimension (mm)				Basic Load Rating (kN)		Limit Speed (r/min)		Bearing No.	Mounting dimensions (mm)			Weight (kg)
d	D	B	r (min)	C _r	C _{0r}	Grease Lubrication	Oil Lubrication		d _a Min	D _a Max	r _a Max	
25	52	20.6	1.0	19.30	18.4	7300	9800	3205	31.0	46.0	1.0	0.183
	62	25.4	1.1	29.4	26.8	6700	8900		3205	32.0	55.0	1.0
30	62	23.8	1.0	27.7	27.4	6300	8400	3206	36.0	56.0	1.0	0.303
	72	30.2	1.1	39.0	36.5	5700	7600		3206	37.0	65.0	1.0
35	72	27	1.1	37.5	38.0	5500	7400	3207	42.0	65.0	1.0	0.458
	80	34.9	1.5	49.5	47.5	5000	6600		3207	43.5	71.5	1.5
40	80	30.2	1.1	46.5	52.0	4900	6600	3208	47.0	73.0	1.0	0.627
	90	36.5	1.5	54.5	57.5	4400	5900		3208	48.5	81.5	1.5
45	85	30.2	1.1	40.5	45.0	4400	5900	3209	52.0	78.0	1.0	0.678
	100	39.7	1.5	67.5	72.5	4000	5300		3209	53.5	91.5	1.5
50	90	30.2	1.1	52.5	60.0	4000	5300	3210	57.0	83.0	1.0	0.698
	110	44.4	2.0	81.5	89.5	3600	4800		3210	60.0	100.0	2.0
55	100	33.3	1.5	66.0	76.5	3600	4900	3211	63.5	91.5	1.5	1.070
	120	49.2	2.0	96.5	108.0	3300	4400		3211	65.0	110.0	2.0
60	110	36.5	1.5	70.5	88.0	3400	4500	3212	68.5	101.5	1.5	1.340
	130	54	2.1	113.0	128.0	3000	4000		3212	72.0	118.0	2.0
65	120	38.1	1.5	78.0	99.0	3100	4200	3213	73.5	111.5	1.5	1.680
	140	58.7	2.1	131.0	150.0	2800	3700		3213	77.0	128.0	2.0
70	125	39.7	1.5	86.0	110.0	5900	3900	3214	78.5	116.5	1.5	1.840
	150	63.5	2.1	153.0	168.0	2600	3500		3214	82.0	138.0	2.0
75	130	41.3	1.5	94.0	122.0	2700	3600	3215	83.5	121.5	1.5	2.010
	160	68.3	2.1	172.0	191.0	2400	3200		3215	87.0	148.0	2.0
80	140	44.4	2.0	104.0	131.0	2500	3400	3216	90.0	130.0	2.0	2.710
85	150	49.2	2.0	121.0	155.0	2400	3200	3217	95.0	140.0	2.0	3.480
90	160	52.4	2.0	135.0	170.0	2200	3000	3218	100.0	150.0	2.0	4.240
95	170	55.6	2.1	144.0	184.0	2100	2800	3219	107.0	158.0	2.0	5.100
100	180	60.3	2.1	189.0	234.0	2000	2700	3220	112.0	168.0	2.0	5.880

Double Row Angular Contact Ball Bearing

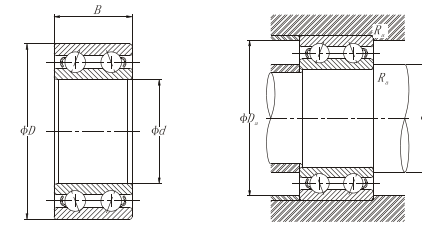

d 10~ 110mm

Boundary dimensions (mm)				Basic Load Rating (kN)		Limit Speed (r/min)		Bearing No.	Abutment and filter dimensions (mm)				Weight (kg)
d	D	B	rs min 1	C _r	C _{0r}	Grease Lubrication	Oil Lubrication		Ds min	Ds max	Dh max	R max	
10	30	14.3	0.6	6950	3800	16000	22000	5200	15	25	0.6	17.5	0.049
12	32	15.9	0.6	9150	5050	15000	20000	5201	17	27	0.6	19	0.057
15	35	15.9	0.6	10000	6050	12000	17000	5202	20	30	0.6	21	0.064
17	40	17.5	0.6	12800	7900	10000	15000	5203	22	35	0.6	24	0.096
20	47	20.6	1.0	19000	12100	9000	13000	5204	26	41	1	28	0.153
25	52	20.6	1.0	20600	14300	8000	11000	5205	31	46	1	31.5	0.175
30	62	23.8	1.0	28600	20400	7000	9500	5206	36	56	1	36.5	0.286
35	72	27	1.1	38000	27800	6000	8000	5207	42	65	1	42.5	0.436
40	80	30.2	1.1	42500	32500	5600	7500	5208	47	73	1.0	47.5	0.590
45	85	30.2	1.1	48000	37000	5000	6700	5209	52	78	1.0	50.5	0.640
50	90	30.2	1.1	51000	42000	4000	5300	5210	57	83	1.0	54.0	0.689
55	100	33.3	1.5	63000	53000	3600	4900	5211	63.5	91.5	1.5	60.5	0.986
60	110	36.5	1.5	71500	58500	3400	4500	5212	68.5	101.5	1.5	65.5	1.270
65	120	38.1	1.5	83500	72500	3100	4200	5213	73.5	111.5	1.5	71.0	1.570
70	125	39.7	1.5	90500	79500	2900	3900	5214	78.5	116.5	1.5	74.5	1.800
75	130	41.3	1.5	90000	80500	2700	3600	5215	83.5	121.5	1.5	78.0	1.900
80	140	44.4	2	106000	95500	2500	3400	5216	90	130	2.0	83.5	2.390
85	150	49.2	2	112000	106000	2400	3200	5217	95	140	2.0	91.5	3.060
90	160	52.4	2	140000	129000	2200	3000	5218	100	150	2.0	95.5	3.730
95	170	56	2.1	159000	148000	2800	2100	5219	107	158	2.0	111.0	4.860
100	180	60	2.1	178000	167000	2700	2000	5220	112	168	2.0	118.0	5.940
110	200	70	2.1	212000	212000	2800	2800	5222	122	188	2.0	132.0	8.800

03 | Angular Contact Ball Bearing

Four-point Contact Ball Bearing

d 30 ~ 90mm

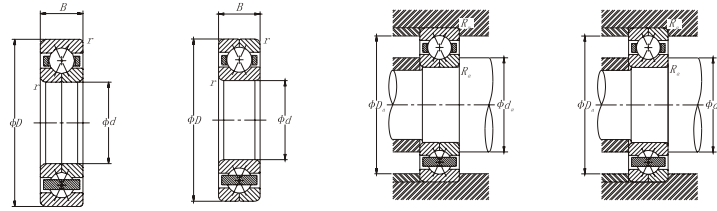

Main Dimension (mm)				Basic Load Rating (kN)		Limit Speed (r/min)		Bearing No.	Mounting dimensions (mm)			Weight (kg)
d	D	B	(r)	C _r	C _{or}	Grease Lubrication	Oil Lubrication		d _a Min	D _a Max	r _a Max	
30	62	16	1.0	31.0	45.0	8500	12000	QJ206	36.0	56.0	1.0	0.240
	72	19	1.1	39.5	57.5	8000	11000	QJ306	37.0	65.0	1.0	0.420
35	72	17	1.1	41.0	61.5	7500	10000	QJ207	42.0	65.0	1.0	0.350
	80	21	1.5	49.5	73.0	7000	9300	QJ307	43.5	71.5	1.5	0.570
40	80	18	1.1	44.0	70.5	6900	9200	QJ208	47.0	73.0	1.0	0.450
	90	23	1.5	60.5	91.5	6200	8200	QJ308	48.5	81.5	1.5	0.780
45	85	19	1.0	49.5	81.0	6200	8200	QJ209	52.0	78.0	1.0	0.520
	100	25	1.5	79.0	121.0	5500	7400	QJ309	53.5	91.5	1.5	1.050
50	90	20	1.1	52.0	89.0	5600	7500	QJ210	57.0	83.0	1.0	0.603
	110	27	2.0	92.0	145.0	5000	6700	QJ310	60.0	100.0	2.0	1.380
55	100	21	1.5	54.0	112.0	5100	6800	QJ211	63.5	91.5	1.5	0.780
	120	29	2.0	106.0	170.0	4600	6100	QJ311	65.0	110.0	2.0	1.760
60	110	22	1.5	77.5	138.0	4700	6300	QJ212	68.5	101.5	1.5	0.978
	130	31	2.1	122.0	198.0	4200	5700	QJ312	72.0	118.0	2.0	2.180
65	120	23	1.5	84.5	153.0	4400	5800	QJ213	73.5	111.5	1.5	0.987
	140	33	2.1	138.0	228.0	3900	5200	QJ313	77.0	128.0	2.0	3.270
70	125	24	1.5	92.0	168.0	4000	5400	QJ214	78.5	116.5	1.5	1.360
	150	35	2.1	155.0	260.0	3600	4800	QJ314	82.0	138.0	2.0	3.900
75	130	25	1.5	96.0	183.0	3800	5000	QJ215	83.5	121.5	1.5	1.530
	160	37	2.1	169.0	294.0	3400	4500	QJ315	87.0	148.0	2.0	3.900
80	140	26	2.0	112.0	217.0	3500	4700	QJ216	90.0	130.0	2.0	2.300
	170	39	2.1	183.0	330.0	3200	4200	QJ316	92.0	158.0	2.0	4.640
85	150	28	2.0	126.0	252.0	3300	4400	QJ217	95.0	140.0	2.0	2300
	180	41	3.0	197.0	370.0	3000	4000	QJ317	99.0	166.0	2.5	5430
90	160	30	2.0	148.0	293.0	3100	4200	QJ218	100.0	150.0	2.0	2.760
	190	43	3.0	212.0	410.0	2800	3800	QJ318	104.0	176.0	2.5	6.310

Four-point Contact Ball Bearing

d 95 ~ 150mm

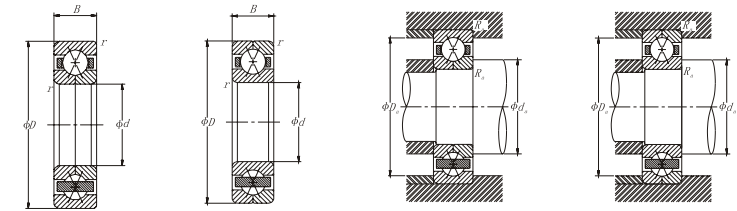

Main Dimension (mm)				Basic Load Rating (kN)		Limit Speed (r/min)		Bearing No.	Mounting dimensions (mm)			Weight (kg)
d	D	B	(r)	C _r	C _{or}	Grease Lubrication	Oil Lubrication		d _a Min	D _a Max	r _a Max	
95	170	32	2.1	168.0	335.0	3000	3900	QJ219	107.0	158.0	2.0	3.350
	200	45	3.0	227.0	450.0	2700	3500	QJ319	109.0	186.0	2.5	7.410
100	180	34	2.1	181.0	355.0	2800	3700	QJ220	112.0	168.0	2.0	4.020
	215	47	3.0	273.0	585.0	2500	3400	QJ320	114.0	201.0	2.5	9.140
105	190	36	2.1	197.0	400.0	2700	3600	QJ221	117.0	178.0	2.0	4.750
	225	49	3.0	273.0	585.0	2400	3200	QJ321	119.0	211.0	2.05	10.4
110	200	38	2.1	213.0	450.0	2500	3400	QJ222	122.0	188.0	2.0	5.620
	240	50	3.0	305.0	680.0	2300	3100	QJ322	124.0	226.0	2.5	12.0
120	215	40	2.1	240.0	540.0	2300	3000	QJ224	132.0	203.0	2.0	6.750
	260	55	3.0	325.0	765.0	2100	2800	QJ324	134.0	246.0	2.5	15.90
130	230	40	3	249.0	585.0	2200	300	QJ226	144.0	216.0	2.5	7.700
	280	58	4	364.0	892.0	1900	2600	QJ326	148.0	262.0	3.0	19.0
140	250	42	3	287.0	713.0	2000	2800	QJ228	154.0	236.0	2.5	9.800
	300	62	4	400.0	1021.0	1700	2400	QJ328	158.0	282.0	3.0	24.0
150	270	45	3	328.0	851.0	1800	2600	QJ230	164.0	256.0	2.5	12.0
	320	65	4	419.0	1131.0	1600	2200	QJ330	168.0	302.0	3.0	29.0

04 | Self Aligning Ball Bearing

Self Aligning ball bearings have spherical outer raceway. The centre of this raceway coincides the centre of the bearing itself. Due to this specific design the rolling elements rotate and align themselves in the event they are misaligned.

These are very useful in applications where there is displacement of the centers around the shaft and housing rotate and deflection are likely to occur.

The standard cage used are staggered type pressed steel cages an snap type pressed steel cages. Additionally Copper alloy machined cages are also available.

For details on boundary dimensions and specifications please refer to the tables overleaf.

Self Aligning Ball Bearing



Self aligning ball bearing

The outer ring raceway of self aligning roller bearing is a spherical surface, its center of curvature corresponds with the bearing center. Therefore, the inner race, outer race, ball and retainer can incline at a certain degree, and can be rotated freely around the bearing center. Its automatic self-aligning ability can correct the misalignment caused by improper processing and installation automatically. It is applicable where axle and case centering is difficult and axle is easy to be crooked.

Self-aligning roller bearings are mostly used to bear radial load. While bearing radial load, it can also bear a small amount of axial load, but not suitable to bear net axial load. Thanks to the self-aligning ability of this bearing, it is suited where the speed is low and self-aligning is required. Where the loading capacity of the self-aligning ball bearing is not enough, the self-aligning roller bearing with self-aligning ability shall be used.

Application scope of self-aligning ball bearing: driving shafts of woodworking machinery and textile machinery.

Self-aligning ball bearings have a cylindrical inner bore or taper inner bore. The tapering of taper inner bore is 1:12 (suffix is K). DPI can provide self-aligning ball bearings whose bore surfaces have cylindrical inner bores or taper inner bores.

DPI can provide seal self-aligning ball bearings with lengthened inner races that facilitate the installation and dismounting. Please consult the technical center of DPI if required.

1. Structural form

1. Conventional type (Fig. 1):

Self-aligning ball bearing whose internal bore surface is cylindrical:

2. Taper bore type (Fig. 2):

Self-aligning ball bearing whose internal bore surface is tapered. The tapering is 1:12:

3. Closed type (Fig. 3)

Self-aligning ball bearing with sealing rings on both sides:

4. Wide inner race type (Fig. 4)

Self-aligning ball bearing whose inner race is lengthened.

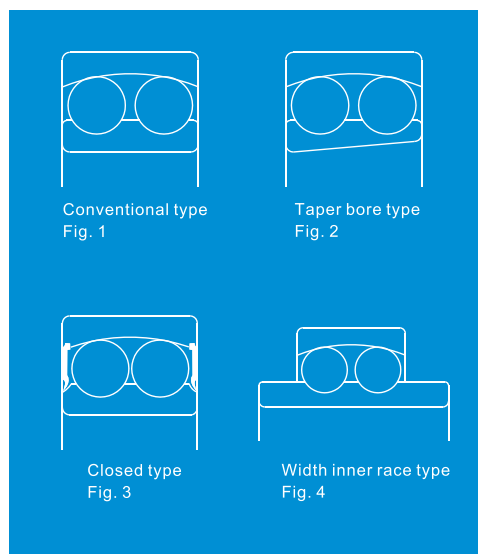

2. Permitted self-aligning angle

The internal structure design of self-aligning ball bearings enables them to have a self-aligning function, which can make the bearings correct the angle alignment errors between the inner and outer races by themselves. In normal load and working conditions, the misalignment angle values given in Table 1 are permitted when the inner race is running. Whether the given values can be reached completely also depends on the design and sealing types of the reference bearing structures, etc.

Bearing series	Permitted misalignment angle values
1200 series	2.5°
1300 series	3°
2200 series	2.5°
2300 series	3°

3. Retainer

The retainers of self-aligning ball bearings often adopt either stamped steel or glass fiber reinforced nylon. If self-aligning ball bearings with nylon retainers are required, please consult the technical center of DPI.

4. Radial Clearance

DPI standard type cylindrical bore self-aligning ball bearings adopt conventional set clearance. Taper self-aligning ball bearings take C3 set clearance as standard type. Self-aligning ball bearings with clearance greater than or less than standardized set can be provided on request. The clearance of inner race lengthened self-aligning ball bearings is between C2 set and conventional set.

5. Scale accuracy & running load

DPI can also provide various self-aligning ball bearings above the ordinary grade of the technical specification for relevant dimensional precision and running accuracy.

6. Dynamic equivalent load

$$\text{When } F_a/F_r > e, P = 0.65F_r + Y_2F_a$$

The relevant calculating coefficient e , Y_1 and Y_2 for each bearing can be found in the dimension table.

7. Static equivalent load

The coefficient value Y_0 for each bearing has been given in the dimension table.

04 | Self Aligning Ball Bearing

Self Aligning Ball Bearing

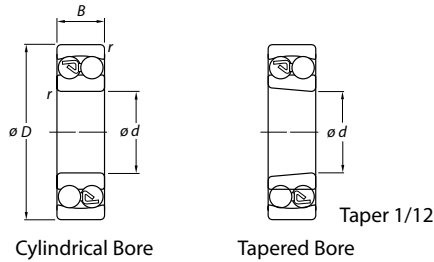

d 10 ~ 40mm

Main Dimension (mm)				Basic Load Rating (kN)		Limit Speed (r/min)		Bearing No.		Mounting dimensions (mm)			Weight (kg)	Constant e	Axial Load Factors		
d	D	B	r (min)	C _r	C _{0r}	Grease Lubrication	Oil Lubrication	Cylindrical bore	Taper Bore	d _s Min	D _s Max	r _s Max			Y ₁	Y ₂	Y ₀
10	30	9	0.6	5.53	1.18	24000	30000	1200	1200K	14.0	26.0	0.6	0.035	0.33	1.9	3	2
	30	14	0.6	8.06	1.73	22000	28000	2200	-	14.0	26.0	0.6	0.050	0.54	1.15	1.8	1.3
	35	11	0.6	7.35	1.62	20000	24000	1300	1300K	14.0	31.0	0.6	0.060	0.35	2.8	1.8	1.9
	35	17	0.6	9.20	2.01	18000	22000	2300	-	14.0	31.0	0.6	0.090	0.71	1.4	0.89	0.93
12	32	10	0.6	6.24	1.43	22000	28000	1201	1201K	16.0	28.0	0.6	0.042	0.33	1.9	3	2
	32	14	0.6	8.52	1.90	20000	26000	2201	-	16.0	28.0	0.6	0.060	0.50	1.25	2	1.3
	37	12	1.0	9.36	2.16	18000	22000	1301	1301K	17.0	32.0	1.0	0.070	0.35	1.8	2.8	1.8
	37	17	1.0	11.70	2.70	17000	20000	2301	-	17.0	32.0	1.0	0.100	0.60	1.05	1.6	1.1
15	35	11	0.6	7.41	1.76	19000	24000	1202	1202K	19.0	31.0	0.6	0.051	0.33	1.9	3	2
	35	14	0.6	8.71	2.04	18000	22000	2202	2202K	19.0	31.0	0.6	0.060	0.43	1.5	2.3	1.6
	42	13	1.0	10.80	2.60	17000	20000	1302	1302K	20.0	37.0	1.0	0.100	0.31	2	3.1	2.2
	42	17	1.0	11.90	2.90	15000	18000	2302	-	20.0	37.0	1.0	0.110	0.52	1.2	1.9	1.3
17	40	12	0.6	8.84	2.20	18000	22000	1203	1203K	21.0	36.0	0.6	0.076	0.31	2	3.1	2.2
	40	16	0.6	10.60	2.55	17000	20000	2203	2203K	21.0	36.0	0.6	0.090	0.43	1.5	2.3	1.6
	47	14	1.0	12.70	3.40	14000	17000	1303	1303K	22.0	42.0	1.0	0.140	0.30	2.1	3.3	2.2
	47	19	1.0	14.60	3.55	13000	16000	2303	-	22.0	42.0	1.0	0.170	0.52	1.2	1.9	1.3
20	47	17	1.0	12.70	3.40	15000	18000	1204	1204K	25.0	42.0	1.0	0.120	0.30	2.1	3.3	2.2
	47	18	1.0	16.80	4.15	14000	17000	2204	2204K	25.0	42.0	1.0	0.150	0.40	1.6	2.4	1.6
	52	15	1.1	14.30	4.00	12000	15000	1304	1304K	26.5	42.0	1.0	0.170	0.28	2.2	3.5	2.5
	52	21	1.1	18.20	4.75	11000	14000	2304	2304K	26.5	45.5	1.0	0.220	0.52	1.2	1.9	1.3
25	52	15	1.0	14.30	4.00	13000	16000	1205	1205K	30.0	47.0	1.0	0.140	0.28	2.2	3.5	2.5
	52	18	1.0	16.80	4.40	11000	14000	2205	2205K	30.0	47.0	1.0	0.190	0.35	1.8	2.8	1.8
	62	17	1.1	19.00	5.40	9500	12000	1305	1305K	31.5	55.5	1.0	0.260	0.28	2.2	3.5	2.5
	62	24	1.1	24.20	6.55	9500	12000	2305	2305K	31.5	55.5	1.0	0.350	0.48	1.3	2	1.4
30	62	16	1.0	15.60	4.65	10000	13000	1206	1206K	35.0	57.0	1.0	0.230	0.25	2.5	3.9	2.5
	62	20	1.0	23.80	6.70	9500	12000	2206	2206K	35.0	57.0	1.0	0.260	0.33	1.9	3	2
	72	19	1.1	22.50	6.80	9000	11000	1306	1306k	36.5	65.5	1.0	0.400	0.25	2.5	3.9	2.5
	72	27	1.1	31.2	8.80	8500	10000	2306	2306k	36.5	65.5	1.0	0.500	0.44	1.4	2.2	1.4
35	72	17	1.1	19.00	6.00	9000	11000	1207	1207k	41.5	65.5	1.0	0.320	0.23	2.7	4.2	2.8
	72	23	1.1	30.70	8.80	8500	10000	2207	2207k	41.5	65.5	1.0	0.440	0.31	2	3.1	2.2
	80	21	1.5	26.50	8.50	7500	9000	1307	1308k	43.0	72.0	1.5	0.540	0.25	2.5	3.9	2.5
	80	31	1.5	39.70	11.20	7000	8500	2307	2307k	43.0	72.0	1.5	0.680	0.46	1.35	2.1	1.4
40	80	18	1.1	19.90	6.95	8500	10000	1208	1208k	46.5	73.5	1.0	0.410	0.22	2.9	4.5	2.8
	80	23	1.1	31.90	10.00	7500	9000	2208	2208k	46.5	73.5	1.0	0.530	0.28	2.2	3.5	2.5
	90	23	1.5	33.80	11.20	6700	8000	1308	1308k	48.0	82.0	1.5	0.710	0.23	2.7	4.2	2.8
	90	33	1.5	54.00	16.00	6300	7500	2308	2308k	48.0	82.0	1.5	0.930	0.40	1.6	2.4	1.6

04 | Self Aligning Ball Bearing

Self Aligning Ball Bearing

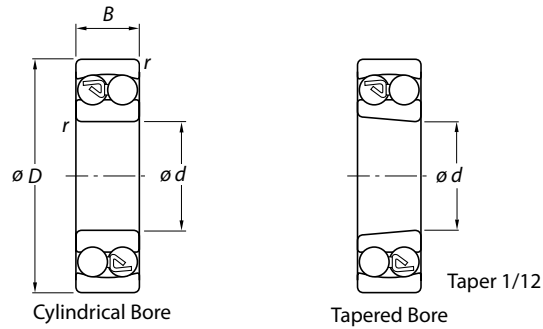

d 45 ~ 80mm

Main Dimension (mm)	Basic Load Rating (kN)		Limit Speed (r/min)		Bearing No.		Mounting dimensions (mm)			Weight (kg)	Constant e	Axial Load Factors					
							<i>d</i> _s Min	<i>D</i> _s Max	<i>r</i> _s Max			<i>Y</i> ₁	<i>Y</i> ₂	<i>Y</i> ₀			
<i>d</i>	<i>D</i>	<i>B</i>	<i>r</i> (min)	<i>C_r</i>	<i>C_{0r}</i>	Grease Lubrication	Oil Lubrication	Cylindrical bore	Taper Bore								
45	85	19	1.1	22.90	7.80	7500	9000	1209	1209k	51.5	78.5	1.0	0.490	0.21	3	4.6	3.2
	85	23	1.1	32.50	10.60	7000	8500	2209	2209k	51.5	78.5	1.0	0.550	0.26	2.4	3.7	2.5
	100	25	1.5	39.00	13.40	6300	7500	1309	1309k	53.0	92.0	1.5	0.960	0.23	2.7	4.2	2.8
	100	36	1.5	63.70	19.30	5600	6700	2309	2309k	53.0	92.0	1.5	1.250	0.33	1.9	3	2
50	90	20	1.1	26.50	9.15	7000	8500	1210	1210k	56.5	83.5	1.0	0.540	0.21	3	4.6	3.2
	90	23	1.1	33.80	11.20	6300	7500	2210	2210k	56.5	83.5	1.0	0.680	0.23	2.7	4.2	2.8
	110	27	2.0	43.60	14.00	5600	6700	1310	1310k	59.0	101.0	2.0	1.210	0.24	2.6	4.1	2.8
	110	40	2.0	63.70	20.00	5300	6300	2310	2310k	59.0	101.0	2.0	1.640	0.43	1.5	2.3	1.6
55	100	21	1.5	27.60	10.60	6300	7500	1211	1211k	63.0	92.0	1.5	0.720	0.19	3.3	5.1	3.6
	100	25	1.5	39.00	13.40	6000	7000	2211	2211k	63.0	92.0	1.5	0.810	0.23	2.7	4.2	2.8
	120	29	2.0	50.70	18.00	5000	6000	1311	1311k	64.0	111.0	2.0	1.580	0.23	2.7	4.2	2.8
	120	43	2.0	76.10	24.00	4800	5600	2311	2311k	64.0	111.0	2.0	2.100	0.40	1.6	2.4	1.6
60	110	22	1.5	31.20	12.20	5600	6700	1212	1212k	68.0	102.0	1.5	0.900	0.19	3.3	5.1	3.6
	110	28	1.5	48.80	17.00	5300	6300	2212	2212k	68.0	102.0	1.5	1.100	0.24	2.6	4.1	2.8
	130	31	2.1	58.50	22.00	4500	5300	1312	1312k	71.0	119.0	2.0	1.960	0.23	2.7	4.2	2.8
	130	46	2.1	87.1	28.50	4500	5300	2312	2312k	71.0	119.0	2.0	2.600	0.33	1.9	3	2
65	120	23	1.5	35.10	14.00	5300	6300	1213	1213K	73.0	112.0	1.5	0.920	0.18	3.5	5.4	3.6
	120	31	1.5	57.20	20.00	5000	6000	2213	2213K	73.0	112.0	1.5	1500	0.24	2.6	4.1	2.8
	140	33	2.1	65.00	25.50	4300	5000	1313	1313K	76.0	129.0	2.0	2.390	0.22	2.9	4.5	2.8
	140	48	2.1	95.60	32.50	4000	4800	2313	2313	76.0	129.0	2.0	3200	0.37	1.7	2.6	1.8
70	125	24	1.5	34.50	13.70	5000	6000	1214	1214K	78.0	117.0	1.5	1.290	0.18	3.5	5.4	3.6
	125	31	1.5	44.20	17.00	4800	5600	2214	2214K	78.0	117.0	1.5	1.620	0.27	2.3	3.6	2.5
	150	35	2.1	74.10	27.50	4000	4800	1314	1314K	81.0	139.0	2.0	3.000	0.22	2.9	4.5	2.8
	150	51	2.1	111.0	37.50	3800	4500	2314	2314K	81.0	139.0	2.0	3.900	0.37	1.7	2.6	1.8
75	130	25	1.5	39.00	15.60	4800	5600	1215	1215K	83.0	122.0	1.5	1.350	0.17	3.7	5.7	4
	130	31	1.5	44.20	18.00	4500	5300	2215	2215K	83.0	122.0	1.5	1.720	0.25	2.5	3.9	2.5
	160	37	2.1	79.30	30.00	3800	4500	1315	1315K	86.0	149.0	2.0	3.600	0.22	2.9	4.5	2.8
	160	55	2.1	124.00	43.00	3400	4000	2315	2315K	86.0	149.0	2.0	4.700	0.37	1.7	2.6	1.8
80	140	23	1.5	39.70	17.00	4500	5300	1216	1216K	89.0	131.0	2.0	1.650	0.16	3.9	6.1	4
	140	33	2.0	65.00	25.50	4000	4800	2216	2216K	89.0	131.0	2.0	2.190	0.22	2.9	4.5	2.8
	170	39	2.1	88.40	33.50	3600	4300	1316	1316K	91.0	159.0	2.0	4.200	0.22	2.9	4.5	2.8
	170	58	2.1	135.00	49.00	3200	3800	2316	2316K	91.0	159.0	2.0	5.700	0.37	1.7	2.6	1.8

04 | Self Aligning Ball Bearing

Self Aligning Ball Bearing

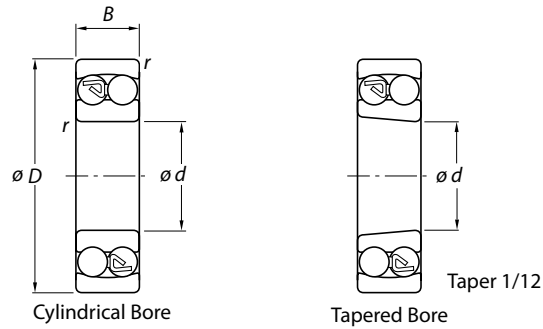

d 85 ~ 110mm

Main Dimension (mm)				Basic Load Rating (kN)		Limit Speed (r/min)		Bearing No.		Mounting dimensions (mm)			Weight (kg)	Constant e	Axial Load Factors		
d	D	B	r (min)	C _r	C _{0r}	Grease Lubrication	Oil Lubrication	Cylindrical bore	Taper Bore	d _a Min	D _a Max	r _a Max			Y ₁	Y ₂	Y ₀
85	150	28	2.0	48.80	20.80	4000	4800	1217	1217K	94.0	141.0	2.0	2.100	0.17	3.7	5.7	4
	150	36	2.0	58.50	23.60	3800	4500	2217	2217K	94.0	141.0	2.0	2.530	0.25	2.5	3.9	2.5
	180	41	3.0	97.50	38.00	3400	4000	1317	1317K	98.0	167.0	2.5	5.000	0.22	2.9	4.5	2.8
	180	60	3.0	140.00	51.00	3000	3600	2317	2317K	98.0	167.0	2.5	6.700	0.37	1.7	2.6	1.8
90	160	30	2.0	57.20	23.60	3800	4500	1218	1218K	99.0	151.0	2.0	2.500	0.17	3.7	5.7	4
	160	40	2.0	70.20	28.50	3600	4300	2218	2218K	99.0	151.0	2.0	3.220	0.27	2.3	3.6	2.5
	190	43	3.0	117.00	44.00	3200	3800	1318	1318K	103.0	177.0	2.5	6.000	0.22	2.9	4.5	2.8
	190	64	3.0	153.00	57.00	2800	3400	2318	2318K	103.0	177.0	2.5	7.900	0.37	1.7	2.6	1.8
95	170	32	2.1	63.70	27.00	3600	4300	1219	1219K	106.0	159.0	2.0	3.000	0.17	3.7	5.7	4
	170	43	2.1	83.20	34.50	3400	4000	2219	2219K	106.0	159.0	2.0	4.200	0.27	2.3	3.6	2.5
	200	45	3.0	133.00	51.00	3000	3600	1319	1319K	108.0	187.0	2.5	7.000	0.23	2.7	4.2	2.8
	200	67	3.0	165.00	64.00	2600	3200	2319	2319K	108.0	187.0	2.5	9.200	0.37	1.7	2.6	1.8
100	180	34	2.1	68.90	30.00	3400	4000	1220	1220K	111.0	169.0	2.0	3.700	0.17	3.7	5.7	4
	180	46	2.1	97.50	40.50	3200	3800	2220	2220K	111.0	202.0	2.5	5000	0.27	2.3	3.6	2.5
	215	47	3.0	143.00	57.00	2800	3400	1320	1320K	113.0	202.0	2.5	8.640	0.23	2.7	4.2	2.8
	215	73	3.0	190.00	80.00	2400	3000	2320	2320K	113.0	202.0	2.5	12.40	0.37	1.7	2.6	1.8
105	190	36	2.1	74.10	32.50	3200	3800	1221	1221K	116.0	179.0	2.0	4.520	0.17	3.7	5.7	4
	190	50	2.1	108.00	45.00	3000	3600	2211	2211K	116.0	179.0	2.0	5.640	0.28	2.2	3.5	2.5
	225	49	3.0	154.00	64.50	2600	3200	1311	1311K	118.0	212.0	2.5	10.00	0.23	2.7	4.2	2.8
	225	77	3.0	200.00	87.00	2400	3000	2311	2311K	118.0	212.0	2.5	14.40	0.37	1.7	2.6	1.8
110	200	38	2.1	88.40	39.00	3000	3600	1222	1222K	121.0	189.0	2.0	5.330	0.17	3.7	5.7	4
	200	53	2.1	124.00	52.00	2800	3400	2222	2222K	121.0	189.0	2.0	6.640	0.28	2.2	3.5	2.5
	240	50	3.0	163.00	72.00	2400	3000	1322	1322K	123.0	227.0	2.5	12.00	0.22	2.9	4.5	2.8
	240	80	3.0	216.00	95.00	2200	2800	2322	2322K	123.0	227.0	2.5	17.40	0.37	1.7	2.6	1.8

Cylindrical Roller Bearings



05 | Cylindrical Roller Bearing

These bearings require feature high radial load as rollers and raceway are in linear contact. These are ideal for applications where there is heavy impact or radial loading. Due their construction they can be very accurately machined and hence are also used in high speed applications. An additional feature of these bearings is that they have a seperable inner and outer ring due to which mounting and dismounting is very easy.

The following types of Cylindrical roller bearings are available:

1. Single Row Cylindrical Roller Bearings:

Within this type they are further subdivided as follows:

- a) NU & N Type: These give good performance when they are used as free side bearings as they adjust to the shafts axial movement to a certain extent.
- b) NJ & NF Type: These carry axial load in one direction
- c) NUP & NH Type: These can carry a certain degree of axial load in both directions.

2. Four point contact ball bearings

These have a contact angle of 35 degrees. The inner ring is divided into 2 pieces. These are very specialized bearings.

The standard cages used are pressed steel cages. Additionally Copper alloy machined cages are also available.

For details on boundary dimensions and specifications please refer to the tables overleaf.

05 | Cylindrical Roller Bearing

Cylindrical roller bearing

The rollers of cylindrical roller bearings are often guided by two ribs of a certain ring. The retainer, roller and guide ring make up an assembly. It can be separated from another ring. They are separable bearings. They are easy to mount and dismount. Especially when tight fit is required for the inner/outer race and the axle/shell, their advantages are more obvious.

This type of bearings is often used to bear radial load. Only single row bearings with ribs on both inner and outer races can bear low constant axial load or high interval axial load.

Compared with deep groove ball bearings of same physical dimensions, this type of bearings radial loading capacity is larger. The requirements for the working accuracy of the axles and shell bores for this type of bearings is higher.

1. Primary structure type

Outer race without rib, inner race with two ribs N type



Outer race without rib, inner race with single rib NU type

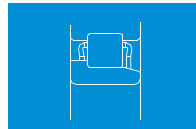

Outer race without rib, inner race with two ribs NU type



Outer race with two ribs, inner race with single rib and a plate NUP type

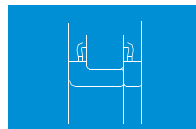

Outer race with single rib, inner race with two ribs NF type



The retainers of bearing of the above structures often include: Pressed structure, nylon fabric, etc. Some models can be full of rollers without retainers.

2. Permitted inclination angle

Generally the axle of the cylindrical roller bearings is not permitted to incline to the outer bore. But, when the load is light, the axial directions of the inner and outer races of the single row cylindrical roller bearings are permitted to incline 2' mutually. If the load is heavier, the permissible error is also larger, but is not permitted to exceed 4'.

3. Tolerance and clearance

As required, products of different grades of tolerance can be provided. See the above section tolerance for the tolerance values.

4. Axial load capacity

For cylindrical roller bearings with inner and outer races, their axial load is related to radial load the bear and the lubricating methods. Maximum permitted axial load.

$$F_{ap} = KC_{Or} \left(\frac{n_g - n}{n_g - 2n} \right) \text{ Oil Lubrication}$$

$$F_{ap} = KC_{Or} \left(\frac{n_g - 2.5n}{n_g - 10n} \right) \text{ Grease Lubrication}$$

$$F_{ap} < 0.4F_r$$

In the equations:

F_{ap}: Maximum permitted axial load N

K: Coefficient relating to the bearing dimensions series

For 2,3 series K=0.2

22,33 series k=0.16

C_{Or}: Static radial load rating of bearings N

N_g: The limit speed when the bearing bears radial load, when Fr > 0.1Cr, the limit speeds listed in the dimension table shall be multiplied by the decreasing coefficient r/min.

N: Bearing working speed r/min

The axial load determined by the above formula acan make Grade 0 tolerance bearing (except improved and reinforced bearings) work normally in the following conditions.

Bearing temperature rise is 55°C for oil lubrication and 40°C for grease lubrication. The bearing maximum temperature is 90°C (the used lubricating oil viscosity is V50=33mm2/s and the drop point of grease is 170°C).

For interval axial load, the permitted axial load can be improved 1 time and for transient one, it can be improved 2 times. According to the working conditions, single row cylindrical roller bearings with lareger axial load capacity can be provided.

5. Dynamic equivalent radial load

$$P_r = F_r$$

For cylindrical roller bearings bearing axial load

2, 3 series

22,23 series

$$P_r = F_r + 0.3F_a \quad (0 \leq F_a / F_r \leq 0.12)$$

$$P_r = F_r + 0.2F_a \quad (0 \leq F_a / F_r \leq 0.18)$$

$$P_r = 0.94F_r + 0.8F_a \quad (0.12 \leq F_a / F_r \leq 0.3)$$

$$P_r = 0.94F_r + 53F_a \quad (0.18 \leq F_a / F_r \leq 0.3)$$

6. Static equivalent radial load

$$P_{Or} = F_r$$

05 | Cylindrical Roller Bearing

Single Row Cylindrical Roller Bearings

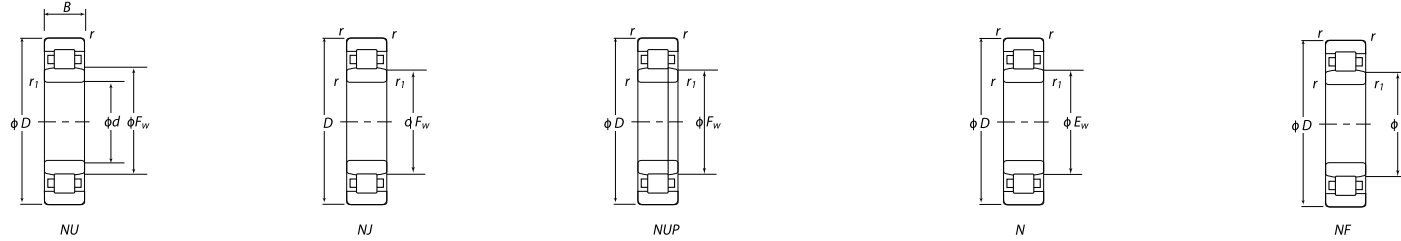

d 15 ~ 30mm

d	Main Dimension (mm)						Basic Load Rating (kN)		Limit Speed (r/min)		Bearing No.		Bearing No.			Mounting dimensions (mm)										Weight (kg)
	D	B	F _w	E _w	(r)	(r ₁)	C _r	C _{0r}	Grease Lubrication	Oil Lubrication	NU Type	NJ Type	NUP Type	N Type	NF Type	D _s Min	D ₁ Min	D ₂ Max	D ₃ Min	D ₄ Min	d _h Max	d ₁ Max	d ₁ Min	R Max	R ₁ Max	
15	35	11	19.3	29.3	0.6	0.3	7.5	3.5	17000	20000	NU202	NJ202	-	N202	NF202	19	20	24	27	21	30	31	30	0.6	0.3	0.005
	35	11	19.3	30.3	0.6	0.3	11.5	9.5	15000	19000	NU202E	NJ202E	-	N202E	-	19	-	24	27	21	30	-	-	0.6	0.3	0.005
17	40	12	22.9	33.9	0.6	0.3	8.7	4.7	15000	19000	NU203	NJ203	NU203	N203	NF203	21	20	25	28	24	35	36	35	0.6	0.3	0.009
	40	12	22.1	35.1	0.6	0.3	17.2	14.3	15000	18000	NU203E	NJ203E	NUP203E	N203E	-	21	-	25	28	24	35	-	-	0.6	0.3	0.009
	40	16	22.1	-	0.6	0.6	19.8	16.3	14000	17000	NU2203E	NJ2203E	NUP2203E	-	-	21	-	25	28	24	32	-	-	0.6	0.3	0.011
	47	14	24.0	40.2	1.1	0.6	19.2	15.3	14000	17000	NU303E	NJ303E	NUP303E	-	-	24	-	26	29	32	42	-	-	1	0.6	0.135
20	47	14	27.0	40.0	1.0	0.6	16.6	13.9	17000	20000	NU204	NJ204	NUP204	N204	NF204	24	25	26	29	32	42	43	42	1	0.6	0.111
	47	14	26.5	-	1.0	0.6	25.7	22.6	15000	18000	NU204E	NJ204E	NUP204E	-	-	24	-	26	29	32	42	-	-	1	0.6	0.122
	47	18	27.0	40.0	1.0	0.6	22.2	20.3	15000	18000	NU2204	NJ2204	NUP2204	N2204	-	24	25	26	29	32	42	43	42	1	0.6	0.143
	47	18	26.5	-	1.0	0.6	30.5	28.3	14000	16000	NU2204E	NJ2204E	NUP2204E	-	-	24	-	26	29	32	42	-	-	1	0.6	0.158
	52	15	28.5	44.5	1.1	0.6	23.1	19.2	14000	17000	NU304	NJ304	NUP304	N304	NF304	24	26.5	27	30	33	45.5	48	47	1	0.6	0.153
	52	15	27.5	-	1.1	0.6	31.5	26.9	13000	15000	NU304E	NJ304E	NUP304E	-	-	24	-	27	30	33	45.5	-	-	1	0.6	0.176
	52	21	28.5	44.5	1.1	0.6	33.0	30.0	13000	15000	NU2304	NJ2304	NUP2304	N2304	-	24	26.5	27	30	33	45.5	48	47	1	0.6	0.250
	52	21	27.5	-	1.1	0.6	42.0	39.0	12000	14000	NU2304E	NJ2304E	NUP2304E	-	-	24	-	27	30	33	45.5	-	-	1	0.6	0.240
25	47	12	30.5	41.5	0.6	0.3	15.1	14.1	16000	19000	NU1005	NJ1005	NUP1005	N1005	-	27	29	30	32	33	43	45	42.5	0.6	0.3	0.092
	52	15	32.0	45.0	1.0	0.6	18.8	17.0	14000	16000	NU205	NJ205	NUP205	N205	NF205	29	30	31	34	37	48	47	1	0.6	0.137	
	52	15	31.5	-	1.0	0.6	29.3	27.7	13000	15000	NU205E	NJ205E	NUP205E	-	-	29	-	31	34	37	47	-	-	1	0.6	0.151
	52	18	32.0	45.0	1.0	0.6	25.1	24.7	13000	15000	NU2205	NJ2205	NUP2205	N2205	-	29	30	31	34	37	47	48	47	1	0.6	0.166
	52	18	31.5	-	1.0	0.6	35.0	34.5	11000	13000	NU2205E	NJ2205E	NUP2205E	-	-	29	-	31	34	37	47	-	-	1	0.6	0.0186
	62	17	35.0	53.0	1.1	1.1	31.5	27.7	12000	14000	NU305	NJ305	NUP305	N305	NF305	31.5	31.5	33	37	40	55.5	55.5	55.5	1	1	0.241
	62	17	34.0	-	1.1	1.1	41.5	37.5	11000	13000	NU2305E	NJ2305E	NUP305E	-	-	31.5	-	33	37	40	55.5	-	-	1	1	0.275
	62	17	35.0	53.0	1.1	1.1	46.0	45.0	11000	12000	NU2305	NJ2305	NUP2305	N2305	-	31.5	31.5	33	37	40	55.5	55.5	55.5	1	1	0.343
	62	24	34.0	-	1.1	1.1	57.0	56.0	9700	11000	NU2305E	NJ2305E	NUP2305E	-	-	31.5	-	33	37	40	55.5	-	-	1	1	0.386
	80	21	38.8	62.8	1.5	1.5	46.5	40.0	8500	10000	NU405	NJ405	NUP405	N405	NF405	33	33	38	41	46	72	72	64	1.5	1.5	0.550
30	55	13	36.5	48.5	1.0	0.6	19.7	19.6	14000	16000	NU1006	NJ1006	NUP1006	N1006	-	33	35	35	38	39.5	50	52	50	1	0.6	0.130
	62	16	38.5	53.5	1.0	0.6	24.9	23.3	12000	14000	NU206	NJ206	NUP206	N206	NF206	34	35	37	40	44	57	58	56	1	0.6	0.207
	62	16	37.5	-	1.0	0.6	39.0	37.5	11000	13000	NU206E	NJ206E	NUP206E	-	-	34	-	37	40	44	57	-	-	1	0.6	0.226
	62	20	38.5	53.5	1.0	0.6	35.0	36.0	11000	13000	NU2206	NJ2206	NUP2206	N2206	-	34	35	37	40	44	57	58	56	1	0.6	0.261
	62	20	37.5	-	1.0	0.6	49.0	50.0	9700	11000	NU2206E	NJ2206E	NUP2206E	-	-	34	-	37	40	44	57	-	-	1	0.6	0.297
	72	19	42.0	62.0	1.1	1.1	38.5	35.0	10000	12000	NU306	NJ306	NUP306	N306	NF306	36.5	36.5	40	44	48	65.5	66	64	1	1	0.358
	72	19	40.5	-	1.1	1.1	53.0	50.0	9300	11000	NU306E	NJ306E	NUP306E	-	-	36.5	-	40	44	48	65.5	-	-	1	1	0.398
	72	27	42.0	62.0	1.1	1.1	51.5	51.0	9000	11000	NU2306	NJ2306	NUP2306	N2306	-	36.5	36.5	40	44	48	65.5	66	64	1	1	0.513
	72	27	40.5	-	1.1	1.1	74.5	77.5	8300	9700	NU2306E	NJ2306E	NUP26306E	-	-	36.5	-	40	44	48	65.5	-	-	1	1	0.580
	90	23	45.0	73.0	1.5	1.5	62.5	55.0	7300	8500	NU406	NJ406	NUP406	N406	NF406	38	38	44	47	52	82	82	74	1.5	1.5	0.751

05 | Cylindrical Roller Bearing

Single Row Cylindrical Roller Bearings

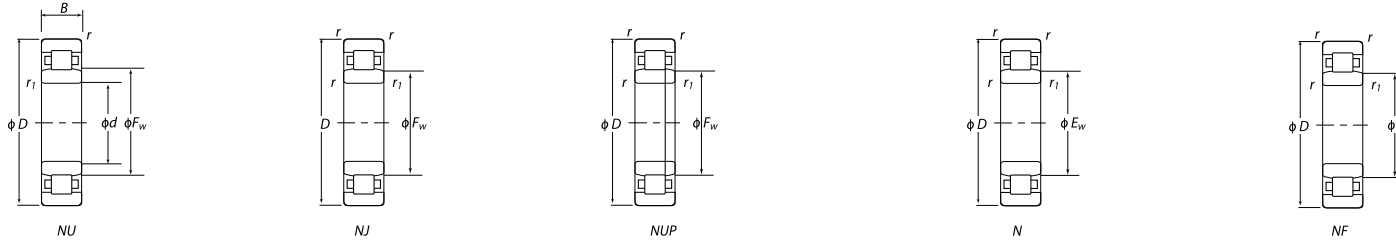

d 35 ~ 50mm

d	Main Dimension (mm)						Basic Load Rating (kN)		Limit Speed (r/min)		Bearing No.		Bearing No.			Mounting dimensions (mm)										Weight (kg)
	D	B	F _w	E _w	(r)	(r ₁)	C _r	C _{0r}	Grease Lubrication	Oil Lubrication	NU Type	NJ Type	NUP Type	N Type	NF Type	D _s Min	D ₁ Min	D ₂ Max	D ₃ Min	D ₄ Min	d _h Max	d _i Max	d _i Min	R Max	R ₁ Max	
35	62	14	42.0	55.0	1.0	0.6	22.6	23.02	12000	15000	NU1007	NJ1007	NUP1007	N1007	-	38	40	41	44	45	57	59	56	1	0.6	0.179
	72	17	43.8	61.8	1.1	0.6	35.5	34.0	11000	12000	NU207	NJ207	NUP207	N207	NF207	39	41.5	43	46	50	65.5	68	64	1	0.6	0.295
	72	17	44.0	-	1.1	0.6	50.5	50.0	9500	11000	NU207E	NJ207E	NUP207E	-	-	39	-	43	46	50	65.5	-	-	1	0.6	0.327
	72	23	43.8	61.8	1.1	0.6	52.0	55.5	9500	11000	NU2207	NJ2207	NUP2207	N2207	-	39	41.5	43	46	50	65.5	68	64	1	0.6	0.404
	72	23	44.0	-	1.1	0.6	61.5	65.5	8500	10000	NU2207E	NJ2207E	NUP2207E	-	-	39	-	43	46	50	65.5	-	-	1	0.6	0.455
	80	21	46.2	68.2	1.5	1.1	49.5	47.0	9000	11000	NU307	NJ307	NUP307	N307	NF307	41.5	43	45	48	53	72	74	71	1.5	1	0.461
	80	21	46.2	-	1.5	1.1	71.0	71.0	8100	9600	NU307E	NJ307E	NUP307E	-	-	41.5	-	45	48	53	72	-	-	1.5	1	0.545
	80	31	46.2	68.2	1.5	1.1	64.5	65.5	7900	8300	NU2307	NJ2307	NUP2307	N2307	-	41.5	43	45	48	53	72	74	71	1.5	1	0.712
	80	31	46.2	-	1.5	1.1	99.0	19.0	7200	8500	NU2307E	NJ2307E	NUP2307E	-	-	41.5	-	45	48	53	72	-	-	1.5	1	0.780
	100	25	53.0	83.0	1.5	1.5	75.5	69.0	6400	7500	NU407	NJ407	NUP407	N407	NF407	43	43	52	55	61	92	92	84	1.5	1.5	0.990
40	68	15	74.0	61.0	1.0	0.6	27.3	29.0	11000	13000	NU1008	NJ1008	NUP1008	N1008	-	44	45	46	49	50.5	63	64	62	1	0.6	0.221
	80	18	50.0	70.0	1.1	1.1	43.5	42.0	9400	11000	NU208	NJ208	NUP208	N208	NF208	46.5	46.5	49	52	56	73.5	74	72	1	1	0.378
	80	18	49.5	-	1.1	1.1	55.5	55.5	8500	10000	NU208E	NJ208E	NUP208E	-	-	46.5	-	49	52	56	73.5	-	-	1	1	0.426
	80	23	50.0	70.0	1.1	1.1	58.0	62.0	8500	10000	NU2208	NJ2208	NUP2208	N2208	-	46.5	46.5	49	52	56	73.5	74	72	1	1	0.49
	80	23	49.5	-	1.1	1.1	72.5	77.5	7600	8900	NU2208E	NJ2208E	NUP2208E	-	-	46.5	-	49	52	56	73.5	-	-	1	1	0.552
	90	23	53.5	77.5	1.5	1.5	58.5	57.0	8000	9400	NU308	NJ308	NUP308	N308	NF308	48	48	51	55	60	82	82	80	1.5	1.5	0.658
	90	23	52.0	-	1.5	1.5	83.0	81.5	7200	8500	NU308E	NJ308E	NUP308E	-	-	48	-	51	55	60	82	-	-	1.5	1.5	0.754
	90	33	53.5	-	1.5	1.5	82.5	88.0	7000	8200	NU2308	NJ2308	NUP2308	N2308	-	48	48	51	55	60	82	82	80	1.5	1.5	0.951
	90	33	52.0	-	1.5	1.5	114.0	122.0	6400	7500	NU2308E	NJ2308E	NUP2308E	-	-	48	-	51	55	60	82	-	-	1.5	1.5	1.06
	110	27	58.0	92.0	2.0	2.0	95.5	89.0	5700	6700	NU408	NJ408	NUP408	N408	NF408	49	49	57	60	67	101	101	93	2	2	1.29
45	75	16	52.5	67.5	1.0	1.0	31.0	34.0	9900	12000	NU1009	NJ1009	NUP1009	N1009	-	49	50	52	54	56	70	71	69	1	0.6	0.282
	85	19	55.0	75.0	1.1	1.1	46.0	47.0	8400	9900	NU209	NJ209	NUP209	N209	NF209	51.5	51.5	54	57	61	78.5	79	77	1	1	0.432
	85	19	54.5	-	1.1	1.1	63.0	66.5	7600	9000	NU209E	NJ209E	NUP209E	-	-	51.5	-	54	57	61	78.5	-	-	1	1	0.496
	85	23	55.0	75.0	1.1	1.1	61.5	68.0	7600	9000	NU2209	NJ2209	NUP2209	N2209	-	51.5	51.5	54	57	61	78.5	79	77	1	1	0.531
	85	23	54.5	-	1.1	1.1	76.0	84.5	6800	8000	NU2209E	NJ2209E	NUP2209E	-	-	51.5	-	54	57	61	78.5	-	-	1	1	0.601
	100	25	58.5	86.5	1.5	1.5	69.79	77.5	7200	8400	NU309	NJ309	NUP309	N309	NF309	53	53	57	60	66	92	92	89	1.5	1.5	0.877
	100	25	58.5	-	1.5	1.5	97.5	98.5	6500	7600	NU309E	NJ309E	NUP309E	-	-	53	-	57	60	66	92	-	-	1.5	1.5	0.995
	100	36	58.8	86.5	1.5	1.5	106.0	113.0	6300	7400	NU2309	NJ2309	NUP2309	N2309	-	53	53	57	60	66	92	89	1.5	1.5	1.27	
	100	36	58.5	-	1.5	1.5	137.0	153.0	5700	6800	NU2309E	NJ2309E	NUP2309E	-	-	53	-	57	60	66	92	-	-	1.5	1.5	1.41
	120	29	64.5	100.5	2.0	2.0	115.0	112.0	5100	6000	NU409	NJ409	NUP409	N409	NF409	54	54	63	66	74	111	111	102	2	2	1.62
50	80	16	57.5	72.5	1.0	1.0	32.0	36.0	8900	11000	NU1010	NJ1010	NUP1010	N1010	-	54	55	57	59	61	75	76	74	1	0.6	0.295
	90	20	60.34	80.4	1.1	1.1	50.5	54.5	7600	9000	NU210	NJ210	NUP210	N210	NF210	56.5	56.5	58	62	67	83.5	84	83	1	1	0.47
	90	20	59.5	-	1.1	1.1	66.0	72.0	6900	8100	NU210E	NJ210E	NUP210E	-	-	56.5	-	58	62	67	83.5	-	-	1	1	0.541
	90	23	60.4	80.4	1.1	1.1	67.5	78.5	6900	8100	NU2210	NJ2210	NUP2210	N2210	-	56.5	56.5	58	62	67	83.5	84	83	1	1	0.571
	90	23	59.5	-	1.1	1.1	67.5	78.5	6200	7300	NU2210E	NJ2210E	NUP2201E	-	-	56.5	-	58	62	67	83.5	-	-	1	1	0.652
	110	27	65.0	2.0	2.0	2.0	87.0	86.0	6500	7700	NU310	NJ310	NUP310	N310	NF310	59	59	63	67	73	101	101	98	2	2	1.14
	110	27	65.0	-	2.0	2.0	110.0	113.0	5900	6900	NU310E	NJ310E	NUP310E	-	-	59	-	63	67	73	101	-	-	2	2	1.31
	110	40	65.0	95.0	2.0	2.0	121.0	131.0	5700	6700	NU2310	NJ2310	NUP2310	N2310	-	59	59	63	67	73	101	101	98	2	2	1.68
	110	40	65.0	-	2.0	2.0	163.0	187.0	5200	6100	NU2310E	NJ2310E	NUP2310E	-	-	59	-	63	67	73	101	-	-	2	2	1.88
	130	31	70.8	110.8	2.1	2.1	139.0	136.0	4700	5500	NU410	NJ410	NUP410	N410	NF410	61	61	69	73	81	119	119	112	2	2	2.02

05 | Cylindrical Roller Bearing

Single Row Cylindrical Roller Bearings

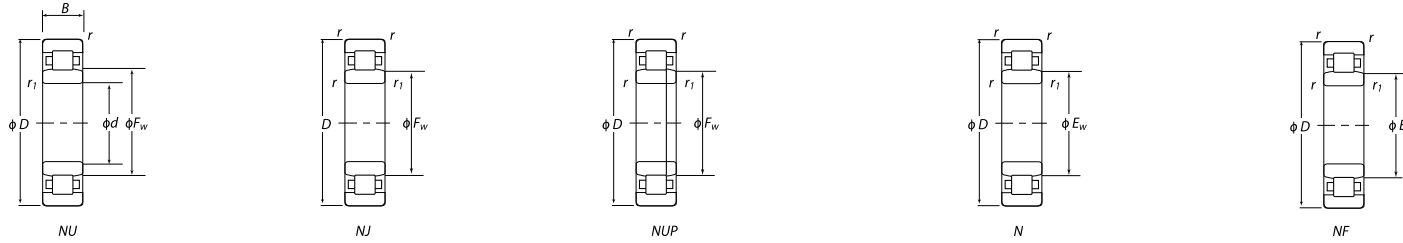

d 55 ~ 70mm

d	Main Dimension (mm)						Basic Load Rating (kN)		Limit Speed (r/min)		Bearing No.		Bearing No.			Mounting dimensions (mm)										Weight (kg)
	D	B	F _w	E _w	(r)	(r ₁)	C _r	C _{0r}	Grease Lubrication	Oil Lubrication	NU Type	NJ Type	NUP Type	N Type	NF Type	D _s Min	D ₁ Min	D ₂ Max	D ₃ Min	D ₄ Min	d _h Max	d ₁ Max	d ₁ Min	R Max	R ₁ Max	
55	90	18	64.5	80.5	1.1	1.1	37.5	44.0	8200	9700	NU1011	NJ1011	NUP1011	N1011	-	60	61.5	63	66	68.5	83.5	85	82	1	1	0.442
	100	21	66.5	88.5	1.5	1.5	61.0	66.5	6900	8200	NU211	NJ211	NUP211	N211	NF211	61.5	63	65	68	73	92	94	91	1.5	1	0.638
	100	21	66.0	-	1.5	1.5	82.5	93.0	6300	7400	NU211E	NJ211E	NUP211E	-	-	61.5	-	65	68	73	92	-	-	1.5	1	0.718
	100	25	66.5	88.5	1.5	1.5	79.0	93.0	6300	7400	NU2211	NJ2211	NUP2211	N2211	-	61.5	63	65	68	73	92	94	91	1.5	1	0.773
	100	25	66.0	-	1.5	1.5	97.0	114.0	5600	6600	NU2211E	NJ2211E	NUP2211E	-	-	61.5	-	65	68	73	92	-	-	1.5	1	0.968
	120	29	70.5	104.5	2.0	2.0	111.0	111.0	5900	7000	NU311	NJ311	NUP311	N311	NF311	64	64	69	72	80	111	111	107	2	2	1.45
	120	29	70.5	-	2.0	2.0	137.0	143.0	5300	6300	NU311E	NJ311E	NUP311E	-	-	64	-	69	72	80	111	-	-	2	2	1.65
	120	43	70.5	104.5	2.0	2.0	148.0	162.0	5200	6100	NU2311	NJ2311	NUP2311	N2311	-	64	64	69	72	80	111	111	107	2	2	2.17
	120	43	70.5	-	2.0	2.0	201.0	233.0	4700	5600	NU2311E	NJ2311E	NUP2311E	-	-	64	-	69	72	80	111	-	-	2	2	2.37
	140	33	77.2	117.2	2.1	2.1	139.0	138.0	4300	5000	NU411	NJ411	NUP411	N411	NF411	66	66	76	79	87	129	129	109	2	2	2.48
60	95	18	69.5	85.5	1.1	1.1	40.0	48.5	7500	8800	NU1012	NJ1012	NUP1012	N1012	-	65	66.5	68	71	73.5	88.5	90	87	1	1	0.474
	110	22	73.5	97.5	1.5	1.5	72.0	80.0	6400	7600	NU212	NJ212	NUP212	N212	NF212	68	68	71	75	80	102	102	100	1.5	1.5	0.818
	110	22	72.0	-	1.5	1.5	97.5	107.5	5800	6800	NU212E	NJ212E	NUP212E	-	-	68	-	71	75	80	102	-	-	1.5	1.5	0.923
	110	28	73.5	97.5	1.5	1.5	101.0	123.0	5800	6800	NU2212	NJ2212	NUP2212	N2212	-	68	68	71	75	80	102	102	100	1.5	1.5	1.06
	110	28	72.0	-	1.5	1.5	131.0	157.0	5200	6100	NU2212E	NJ2212E	NUP2212E	-	-	68	-	71	75	80	102	-	-	2	2	1.21
	130	31	77.0	113.0	2.1	2.1	124.0	126.0	5500	6500	NU312	NJ312	NUP312	N312	NF312	71	71	75	79	86	119	119	116	2	2	1.82
	130	31	77.0	-	2.1	2.1	150.0	157.0	4900	5800	NU312E	NJ312E	NUP312E	-	-	71	-	75	79	86	119	-	-	2	2	2.05
	130	46	77.0	113.0	2.1	2.1	169.0	188.0	4800	5700	NU2312	NJ2312	NUP2312	N2312	-	71	71	75	79	86	119	119	116	2	2	2.71
	130	46	77.0	-	2.1	2.1	222.0	262.0	4400	5200	NU2312E	NJ2312E	NUP2312E	-	-	71	-	75	79	86	119	-	-	2	2	2.96
	150	35	83.0	127.0	2.1	2.1	167.0	168.0	3900	4600	NU412	NJ412	NUP412	N412	NF412	71	71	82	85	94	139	139	128	2	2	3.02
65	100	18	74.5	90.5	1.1	1.0	41.0	51.0	7000	8200	NU1013	NJ1013	NUP1013	N1013	-	70	71.5	73	76	78.5	93.5	95	92	1	1	0.485
	120	23	79.6	105.6	1.5	1.5	84.0	94.5	5900	7000	NU213	NJ213	NUP213	N213	NF213	73	73	77	81	87	112	112	108	1.5	1.5	1.02
	120	23	78.5	-	1.5	1.5	108.0	119.0	5400	6300	NU213E	NJ213E	NUP213E	-	-	73	-	77	81	87	112	-	-	1.5	1.5	1.21
	120	31	79.6	105.6	1.5	1.5	120.0	149.0	5400	6300	NU2213	NJ2213	NUP2213	N2213	-	73	73	77	81	87	112	112	108	1.5	1.5	1.41
	120	31	78.5	-	1.5	1.5	149.0	181.0	4800	5600	NU2213E	NJ2213E	NUP2213E	-	-	73	-	77	81	87	112	-	-	1.5	1.5	1.62
	140	33	82.5	-	2.1	2.1	135.0	13.0	5100	6000	NU313	NJ313	NUP313	N313	NF313	76	76	81	85	93	129	129	125	2	2	2.23
	140	33	82.5	-	2.1	2.1	181.0	191.0	4600	5400	NU313E	NJ313E	NUP313E	-	-	76	-	81	85	93	129	-	-	2	2	2.54
	140	48	83.5	121.5	2.1	2.1	188.0	212.0	4400	5200	NU2313	NJ2313	NUP2313	N2313	-	76	76	81	85	93	129	129	125	2	2	3.27
	140	48	82.5	-	2.1	2.1	248.0	287.0	4100	4800	NU2313E	NJ2313E	NUP2313E	-	-	76	-	81	85	93	129	-	-	2	2	3.48
	160	37	89.3	135.3	2.1	2.1	195.0	203.0	3600	4300	NU413	NJ413	NUP413	N413	NF413	76	76	88	91	100	149	149	137	2	2	3.61
70	110	20	80.0	100.0	1.0	1.0	58.5	70.5	6500	7600	NU1014	NJ1014	NUP1014	N1014	-	75	76.5	78	82	85	103.5	105	101	1	1	0.699
	125	24	84.5	110.5	1.5	1.5	87.5	101.0	5500	6500	NU214	NJ214	NUP214	N214	NF214	78	78	82	86	92	117	117	114	1.5	1.5	1.12
	125	24	83.5	-	1.5	1.5	119.0	137.0	5000	5900	NU214E	NJ214E	NUP214E	-	-	78	-	82	86	92	117	-	-	1.5	1.5	1.32
	125	31	84.5	110.5	1.5	1.5	125.0	160.0	5000	5900	NU2214	NJ2214	NUP2214	N2214	-	78	78	82	86	92	117	117	114	1.5	1.5	1.47
	125	31	83.5	-	1.5	1.5	156.0	194.0	4500	5200	NU2214E	NJ2214E	NUP2214E	-	-	78	-	82	86	92	117	-	-	1.56	1.56	1.71
	150	35	90.0	130.0	2.1	2.1	158.0	168.0	4700	5500	NU314	NJ314	NUP314	N314	NF314	81	81	87	92	100	139	139	134	2	2	2.71

05 | Cylindrical Roller Bearing

Single Row Cylindrical Roller Bearings

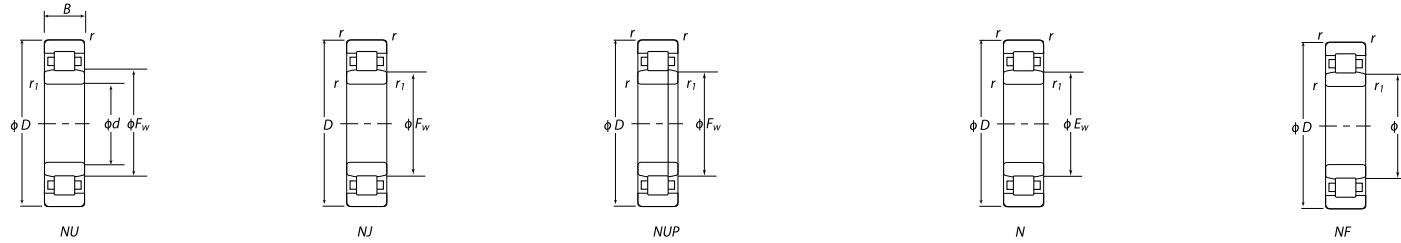

d 70 ~ 85mm

d	Main Dimension (mm)						Basic Load Rating (kN)		Limit Speed (r/min)		Bearing No.		Bearing No.	Mounting dimensions (mm)										Weight (kg)		
	D	B	F _w	E _w	(r)	(r ₁)	C _r	C _{0r}	Grease Lubrication	Oil Lubrication	NU Type	NJ Type		NUP Type	N Type	NF Type	D _s Min	D ₁ Min	D ₂ Max	D ₃ Min	D ₄ Min	d _h Max	d ₁ Max		R Min	R ₁ Max
70	150	35	89.0	-	2.1	2.1	205.0	222.0	1200	5000	NU314E	NJ314E	NUP314E	-	-	81	-	87	92	100	139	-	-	2	2	3.11
	150	51	90.0	130.0	2.1	2.1	223.0	262.0	4100	4800	NU2314	NJ2314	NUP2314	N2314	-	81	81	87	92	100	139	139	134	2	2	3.98
	150	51	89.0	-	2.1	2.1	274.0	325.0	3800	4400	NU2314E	NJ2314E	NUP2314E	-	-	81	-	87	92	100	139	-	-	2	2	4.25
	180	42	100.0	152.0	3.0	3.0	243.0	257.0	3400	4000	NU414	NJ414	NUP414	N414	NF414	83	83	99	102	112	167	167	153	2.2	2.2	5.24
75	115	20	85.0	105.0	1.1	1.0	60.0	74.5	6100	7100	NU1015	NJ1015	NUP1015	N1015	-	80	81.5	83	87	90	108.5	110	106	1	1	0.738
	130	25	88.5	116.5	1.5	1.5	101.0	118.0	5100	6000	NU215	NJ215	NUP215	N215	NF215	83	83	87	90	96	122	122	120	1.5	1.5	1.23
	130	25	88.5	-	1.5	1.5	130.0	156.0	4700	5500	NU215E	NJ215E	NUP215E	-	-	83	-	87	90	96	122	-	-	1.5	1.5	1.41
	130	31	88.5	116.5	1.5	1.5	136.0	172.0	4700	5500	NU2215	NJ2215	NUP2215	N2215	-	83	83	87	90	96	122	122	120	1.5	1.5	1.55
	130	31	88.5	-	1.5	1.5	162.0	207.0	4200	4900	NU2215E	NJ2215E	NUP2215E	-	-	83	-	87	90	96	122	-	-	1.5	1.5	1.79
	160	37	95.5	139.5	2.1	2.1	190.0	205.0	4400	5200	NU315	NJ315	NUP315	N315	NF315	86	86	93	97	106	149	149	143	2	2	3.28
	160	37	95.0	-	2.1	2.1	240.0	263.0	4000	4700	NU315E	NJ315E	NUP315E	-	-	86	-	93	97	106	149	-	-	2	2	3.74
	160	55	95.5	139.5	2.1	2.1	274.0	325.0	3800	4500	NU2315	NJ2315	NUP2315	N2315	-	86	86	93	97	106	149	149	143	2	2	4.87
	160	55	95.0	139.5	2.1	2.1	274.0	325.0	3800	4500	NU2315E	NJ2315E	NUP2315E	-	-	86	-	93	97	106	149	-	-	2	2	5.25
	190	45	104.5	160.5	3.0	3.0	262.0	274.0	3200	3700	NU415	NJ415	NUP415	N145	NF415	88	88	103	107	118	177	177	162	2.5	2.5	6.22
80	125	22	91.5	113.5	1.1	1.0	72.5	90.5	5700	6700	NU1016	NJ1016	NUP1016	N1016	-	85	86.5	90	94	97	118.5	120	115	1	1	0.98
	140	26	95.3	125.3	2.0	2.0	111.0	130.0	4800	5700	NU216	NJ216	NUP216	N216	NF216	89	89	94	97	104	131	131	128	2	2	1.52
	140	26	95.3	-	2.0	2.0	139.0	167.0	4400	5100	NU216E	NJ216E	NUP216E	-	-	89	-	94	97	104	131	-	-	2	2	1.67
	140	33	95.3	125.3	2.0	2.0	154.0	198.0	4400	5100	NU2216	NJ2216	NUP2216	N2216	-	89	89	94	97	104	131	131	128	2	2	1.93
	140	33	95.3	-	2.0	2.0	186.0	243.0	3900	4600	NU2216E	NJ2216E	NUP2216E	-	-	89	-	94	97	104	131	-	-	2	2	2.12
	170	39	103.0	147.0	2.1	2.1	201.0	223.0	4100	4800	NU316	NJ316	NUP316	N316	NF316	91	91	99	105	114	159	159	151	2	2	3.86
	170	39	101.0	-	2.1	2.1	256.0	282.0	2700	4400	NU316E	NJ316E	NUP316E	-	-	91	-	99	105	114	159	-	-	2	2	4.22
	170	58	103.0	147.0	2.1	2.1	274.0	330.0	3600	4200	NU2316	NJ2316	NUP2316	N2316	-	91	91	99	105	114	159	159	151	2	2	5.79
	170	58	101.0	-	2.1	2.1	355.0	430.0	3300	3900	NU2316E	NJ2316E	NUP2316E	-	-	91	-	99	105	114	159	-	-	2	2	6.25
	200	48	110.0	170.0	3.0	3.0	299.0	315.0	3000	3500	NU416	NJ416	NUP416	N416	NF416	93	93	109	112	124	187	187	172	2.5	2.5	7.32
85	130	22	96.5	118.5	1.1	1.0	74.5	95.5	5400	6300	NU1017	NJ1017	NUP1017	N1017	-	90	91.5	95	99	102	123.5	125	120	1	1	1.03
	150	28	101.8	133.8	2.0	2.0	126.0	149.0	4500	5300	NU217	NJ217	NUP217	N217	NF217	94	94	99	104	110	141	141	137	2	2	1.87
	150	28	100.5	-	2.0	2.0	167.0	199.0	4100	4800	NU217E	NJ217E	NUP217E	-	-	94	-	99	104	110	141	-	-	2	2	2.11
	150	36	101.8	133.8	2.0	2.0	178.0	232.0	4100	4800	NU2217	NJ2217	NUP2217	N2217	-	94	94	99	104	110	141	141	137	2	2	2.44
	150	36	100.5	-	2.0	2.0	217.0	279.0	3700	4300	NU2217E	NJ2217E	NUP2217E	-	-	94	-	99	104	110	141	-	-	2	2	2.67
	180	41	108.0	156.0	3.0	3.0	225.0	247.0	3900	4600	NU317	NJ317	NUP317	N317	NF317	98	98	106	110	119	167	167	160	2.5	2.5	4.54
	180	41	108.0	-	3.0	3.0	291.0	330.0	3500	4100	NU317E	NJ317E	NUP317E	-	-	98	-	106	110	119	167	-	-	2.5	2.5	4.81
	180	60	108.0	156.0	3.0	3.0	315.0	380.0	3400	4000	NU2317	NJ2317	NUP2317	N2317	-	98	98	106	110	119	167	167	160	2.5	2.5	6.7
	180	60	108.0	-	3.0	3.0	395.0	485.0	3100	3700	NU2317E	NJ2317E	NUP2317E	-	-	98	-	106	110	119	167	-	-	2.5	2.5	7.16
	210	52	113.0	177.0	4.0	4.0	335.0	350.0	2800	330	NU417	NJ417	NUP417	N417	NF417	101	101	111	115	128	194	194	179	3	3	9.41

05 | Cylindrical Roller Bearing

Single Row Cylindrical Roller Bearings

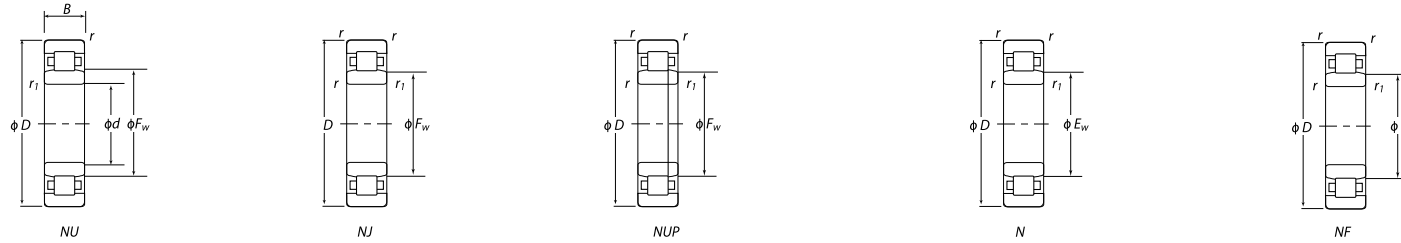

d 90~ 105mm

d	Main Dimension (mm)						Basic Load Rating (kN)		Limit Speed (r/min)		Bearing No.		Bearing No.			Mounting dimensions (mm)										Weight (kg)
	D	B	F _w	E _w	(r)	(r ₁)	C _r	C _{0r}	Grease Lubrication	Oil Lubrication	NU Type	NJ Type	NUP Type	N Type	NF Type	D _s Min	D ₁ Min	D ₂ Max	D ₃ Min	D ₄ Min	d _h Max	d ₁ Max	d ₁ Min	R Max	R ₁ Max	
90	140	24	103.0	127.0	1.5	1.1	88.0	114.0	5100	5900	NU1018	NJ1018	NUP1018	N1018	-	96.5	98	101	106	109	132	134	129	1.5	1	1.33
	160	30	107.0	143.0	2.0	2.0	152.0	178.0	4300	500	NU218	NJ218	NUP218	N218	NF218	99	99	105	109	116	151	151	146	2	2	2.29
	160	30	107.0	-	2.0	2.0	182.0	217.0	3900	4600	NU218E	NJ218E	NUP218E	-	-	99	-	105	109	116	151	-	-	2	2	2.44
	160	40	107.0	143.0	2.0	2.0	207.0	265.0	3900	4600	NU2218	NJ2218	NUP2218	N2218	-	99	99	105	109	116	151	151	146	2	2	3.09
	160	40	107.0	-	2.0	2.0	242.0	315.0	3500	4100	NU2218E	NJ2218E	NUP2218E	-	-	99	-	105	109	116	151	-	-	2	2	3.33
	190	43	115.0	165.0	3.0	3.0	240.0	265.0	3700	4300	NU318	NJ318	NUP318	N318	NF318	103	103	111	117	127	177	177	169	2.5	2.5	5.31
	190	43	113.5	-	3.0	3.0	315.0	355.0	3300	3900	NU318E	NJ318E	NUP318E	-	-	103	-	111	117	127	177	-	-	2.5	2.5	5.72
	190	64	115.0	165.0	3.0	3.0	325.0	395.0	3200	3800	NU2318	NJ2318	NUP2318	N2318	-	103	103	111	117	127	177	177	169	2.5	2.5	7.95
	190	64	113.5	-	3.0	3.0	435.0	535.0	2900	3400	NU2318E	NJ2318E	NUP2318E	-	-	103	-	111	117	127	177	-	-	2.5	2.5	8.56
	225	54	123.5	191.5	4.0	4.0	375.0	400.0	2600	3100	NU418	NJ418	NUP418	N418	NF418	106	106	122	125	139	209	209	194	3	3	11.2
95	145	24	108.0	132.0	1.5	1.1	90.5	120.0	4800	5600	NU1019	NJ1019	NUP1019	N1019	-	101.5	103	106	111	114	137	139	134	1.5	1	1.42
	170	32	113.5	151.5	2.1	2.1	166.0	195.0	4000	4700	NU219	NJ219	NUP219	N219	NF219	106	106	111	116	123	1559	159	155	2	2	2.78
	170	32	112.5	-	2.1	2.1	220.0	265.0	3600	4300	NU219E	NJ219E	NUP219E	-	-	106	-	111	116	123	159	-	-	2	2	3.02
	170	43	113.5	151.5	2.1	2.1	230.0	298.0	3600	4300	NU2219	NJ2219	NUP2219	N2219	-	106	-	111	116	123	159	159	155	2	2	3.79
	170	43	112.5	-	2.1	2.1	286.0	370.0	3300	3800	NU2219E	NJ2219E	NUP2219E	-	-	106	-	111	116	123	159	-	-	2	2	4.14
	200	45	121.5	173.5	3.0	3.0	274.0	310.0	3400	4000	NU319	NJ319	NUP319	N319	NF319	108	108	119	124	134	187	187	178	2.5	2.5	6.13
	200	45	121.5	-	3.0	3.0	335.0	385.0	3100	3600	NU319E	NJ319E	NUP319E	-	-	108	-	119	124	134	187	-	-	2.5	2.5	6.62
	200	67	121.5	173.5	3.0	3.0	395.0	495.0	3000	3500	NU2319	NJ2319	NUP2319	N2319	-	108	108	119	124	134	187	187	178	2.5	2.5	9.21
	200	67	121.5	-	3.0	3.0	460.0	585.0	2700	3200	NU2319E	NJ2319E	NUP2319E	-	-	108	-	119	124	134	187	-	-	2.5	2.5	9.81
	240	55	133.5	201.5	4.0	4.0	400.0	445.0	2500	2900	NU419	NJ419	NUP419	N419	NF419	111	111	132	136	149	224	224	204	3	3	13.2
100	150	24	113.0	137.0	1.5	1.5	93.0	126.	4600	5400	NU1020	NJ1020	NUP1020	N1020	-	106.5	108	111	116	119	142	144	139	1.5	1	1.45
	180	34	120.0	160.0	2.1	2.1	183.0	217.0	3800	4500	NU220	NJ220	NUP220	N220	NF220	111	111	117	122	130	169	169	164	2	2	3.33
	180	34	119.0	-	2.1	2.1	249.0	305.0	3500	4100	NU220E	NJ220E	NUP220E	-	-	111	-	117	122	130	169	-	-	2	2	3.66
	180	46	120.0	160.0	2.1	2.1	258.0	340.0	3500	4100	NU2220	NJ2220	NUP2220	N2220	-	111	111	117	122	130	169	169	164	2	2	4.57
	180	46	119.0	-	2.1	2.1	335.0	445.0	3100	3600	NU2220E	NJ2220E	NUP2220E	-	-	111	-	117	122	130	169	-	-	2	2	5.01
	215	47	127.5	185.5	3.0	3.0	315.0	365.0	3300	3800	NU320	NJ320	NUP320	N320	NF320	113	113	125	132	143	202	202	190	2.5	2.5	7.49
	215	47	127.5	-	3.0	3.0	380.0	425.0	2900	3500	NU320E	NJ320E	NUP320E	-	-	113	-	125	132	143	202	-	-	2.5	2.5	8.57
	215	73	129.5	185.5	3.0	3.0	460.0	590.0	2900	3400	NU2320	NJ2320	NUP2320	N2320	-	113	113	125	132	143	202	202	190	2.5	2.5	11.7
	215	73	127.5	-	3.0	3.0	570.0	715.0	2600	3100	NU2320E	NJ2320E	NUP2320E	-	-	113	-	125	132	143	202	-	-	2.5	2.5	12.8
	250	58	139.0	211.0	4.0	4.0	445.0	495.0	2300	2800	NU420	NJ420	NUP420	N420	NF420	116	116	137	141	156	234	234	213	3	3	14.9
105	160	26	119.5	145.5	2.0	2.0	105.0	142.0	4300	5100	NU1021	NJ1021	NUP1021	N1021	-	111.5	114	118	122	126	151	154	148	2	1	1.84
	190	36	126.8	168.8	2.1	2.1	201.0	241.0	3600	4300	NU221	NJ221	NUP221	N221	NF221	116	116	124	129	137	179	179	173	2	2	3.95
	225	49	135.0	195.0	3.0	3.0	360.0	415.0	3100	3700	NU321	NJ321	NUP321	N321	NF321	118	118	132	137	149	212	212	199	2.5	2.5	8.53
	260	60	144.5	220.5	4.0	4.0	495.0	555.0	2200	2600	NU421	NJ421	NUP421	N421	NF421	121	121	143	147	162	244	244	223	3	3	16.6

05 | Cylindrical Roller Bearing

Single Row Cylindrical Roller Bearings

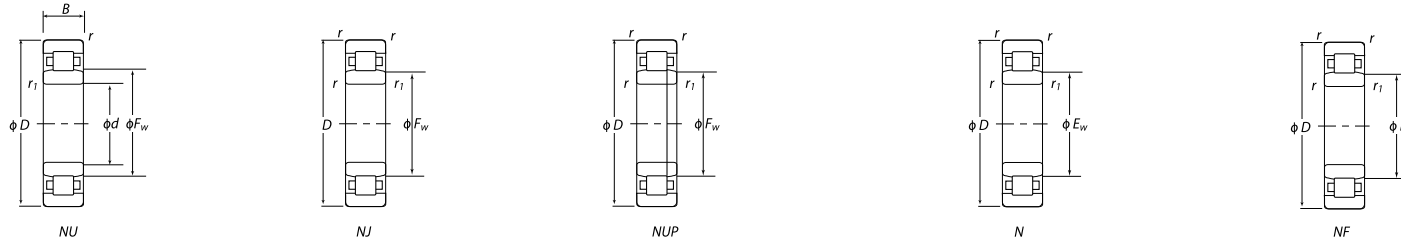

d 110 ~ 140mm

d	Main Dimension (mm)					Basic Load Rating (kN)		Limit Speed (r/min)		Bearing No.		Bearing No.			Mounting dimensions (mm)										Weight (kg)	
	D	B	F _w	E _w	(r)	(r ₁)	C _r	C _{0r}	Grease Lubrication	Oil Lubrication	NU Type	NJ Type	NUP Type	N Type	NF Type	D _s Min	D ₁ Min	D ₂ Max	D ₃ Min	D ₄ Min	d _h Max	d ₁ Max	d ₁ Min	R Max		R ₁ Max
110	170	28	125.0	155.0	2.0	2.0	131.	174.0	4100	4800	NU1022	NJ1022	NUP1022	N1022	-	116.5	119	124	128	132	161	164	157	2	1	2.33
	200	38	132.5	178.5	2.1	2.1	240.0	290.0	3400	4000	NU222	NJ222	NUP222	N222	NF222	121	121	130	135	144	189	189	182	2	2	4.63
	200	38	132.5	-	2.1	2.1	293.0	365.0	3100	3700	NU222E	NJ222E	NUP222E	-	-	121	-	130	135	144	189	-	-	2	2	4.27
	200	53	132.5	178.5	2.1	2.1	335.0	440.0	3100	3700	NU2222	NJ2222	NUP2222	N2222	-	121	121	130	135	144	185	189	182	2	2	6.56
	200	53	132.5	-	2.1	2.1	385.0	515.0	2800	3300	NU2222E	NJ2222E	NUP2222E	-	-	121	-	130	135	144	189	-	-	2	2	7.41
	240	50	143.0	207.0	3.0	3.0	400.0	465.0	3000	3500	NU322	NJ322	NUP322	N322	NF322	123	123	140	145	158	227	227	211	2.5	2.5	10.1
	240	50	143.0	-	3.0	3.0	450.0	525.0	2700	3100	NU322E	NJ322E	NUP322E	-	-	123	123	140	145	158	227	-	-	2.5	2.5	11.1
	240	80	143.0	207.0	3.0	3.0	605.0	790.0	2600	3100	NU2322	NJ2322	NUP2322	N2322	-	123	123	140	145	158	227	227	211	2.5	2.5	17.1
	240	80	143.0	-	3.0	3.0	675.0	880.0	2400	2800	NU2322E	NJ2322E	NUP2322E	-	-	123	-	140	145	158	227	-	-	2.5	2.5	19.4
	280	65	155.0	235.0	4.0	4.0	550.0	620.0	2100	2500	NU422	NJ422	NUP422	N422	NF422	126	126	153	157	173	264	264	237	3	3	21.1
120	180	28	135.0	165.0	2.0	2.0	139.0	191.0	3800	4400	NU1024	NJ1024	NUP1024	N1024	-	126.5	129	134	138	142	171	174	167	2	1	2.44
	215	40	143.5	191.5	2.1	2.1	272.0	340.0	3200	3700	NU224	NJ224	NUP224	N224	NF224	131	131	141	146	156	204	204	196	2	2	5.57
	215	40	143.5	-	2.1	2.1	335.0	420.0	2900	3400	NU224E	NJ224E	NUP224E	-	-	131	-	141	146	156	204	-	-	2	2	5.97
	215	58	143.5	191.5	2.1	2.1	380.0	525.0	2900	3400	NU2224	NJ2224	NUP2224	N2224	-	131	131	141	146	156	204	204	196	2	2	8.19
	215	58	143.5	-	2.1	2.1	450.0	620.0	2600	3000	NU2224E	NJ2224E	NUP2224E	-	-	131	-	141	146	156	204	-	-	2	2	9.18
	215	55	154.0	226.0	3.0	3.0	475.0	550.0	2700	3200	NU324	NJ324	NUP324	N324	NF324	133	133	151	156	171	247	247	230	2.5	2.5	12.8
120	260	55	154.0	-	3.0	3.0	530.0	610.0	2400	2800	NU324E	NJ324E	NUP324E	-	-	133	-	151	156	171	247	-	-	2.5	2.5	13.9
	260	86	154.0	226.0	3.0	3.0	710.0	920.0	2400	2800	NU2324	NJ2324	NUP2324	N2324	-	133	133	151	156	171	247	247	230	2.5	2.5	21.5
	260	86	154.0	-	3.0	3.0	795.0	1030.0	2200	2500	NU2324E	NJ2324E	NUP2324E	-	-	133	-	151	156	171	247	-	-	2.5	2.5	26.1
	310	72	170.0	260.0	5.0	5.0	675.0	770.0	1900	2300	NU424	NJ424	NUP424	N424	NF424	140	140	168	172	190	290	290	262	4	4	28.9
130	200	32	148.0	182.0	2.0	1.1	172.0	238.0	3400	4000	NU1026	NJ1026	NUP1026	N1026	-	136.5	139	146	151	156	191	194	194	2	1	3.69
	230	40	156.0	204.0	3.0	3.0	282.0	360.0	2900	3400	NU226	NJ226	NUP226	N226	NF226	143	143	151	158	168	217	217	208	2.5	2.5	6.32
	230	40	153.5	-	3.0	3.0	365.0	455.0	2600	3100	NUNU226E	NJ226E	NUP226E	-	-	143	-	151	158	168	217	-	-	2.5	2.5	6.92
	230	64	156.0	204.0	3.0	3.0	395.0	560.0	2600	3400	NU2226	NJ2226	NUP2226	N2226	-	143	143	151	158	168	217	217	208	2.5	2.5	10.2
	230	64	153.5	-	3.0	3.0	530.0	735.0	2300	2700	NU2226E	NJ2226E	NUP2226E	-	-	143	-	151	158	168	217	-	-	2.5	2.5	11.8
	280	58	167.0	243.0	4.0	4.0	560.0	665.0	2500	2900	NU326	NJ326	NUP326	N326	NF326	146	146	164	169	184	264	-	-	3	3	30.9
	280	58	167.0	-	4.0	4.0	615.0	735.0	2200	2600	NU326E	NJ326E	NUP326E	-	-	146	-	164	169	184	264	-	-	3	3	19.4
	280	93	167.0	243.0	4.0	4.0	840.0	1130.0	2200	2600	NU2326	NJ2326	NUP2326	N2326	-	146	146	164	169	184	264	264	247	3	3	26.9
	280	93	167.0	-	4.0	4.0	920.0	1230.0	2000	2300	NU2326E	NJ2326E	NUP2326E	-	-	146	-	164	169	184	264	-	-	3	3	30.9
	340	78	185.0	285.0	5.0	5.0	825.0	955.0	1800	2100	NU426	NJ426	NUP426	N426	NF426	150	150	183	187	208	320	320	287	4	4	37.7
140	210	33	158.0	192.0	2.0	1.1	176.0	250.0	3200	3800	NU1028	NJ1028	NUP1028	N1028	-	146.5	149	156	161	166	201	204	194	2	1	4.05
	250	42	169.0	221.0	3.0	3.0	325.0	420.0	2700	3100	NU228	NJ228	NUP228	N228	NF228	153	153	166	171	182	237	237	225	2.5	2.5	7.88
	250	42	169.0	-	3.0	3.0	395.0	515.0	2400	2800	NU228E	NJ228E	NUP228E	-	-	153	-	166	171	182	237	-	-	2.5	2.5	8.73
	250	68	169.0	221.0	3.0	3.0	465.0	670.0	2400	2800	NU2228	NJ2228	NUP2228	N2228	-	153	153	166	171	182	237	237	225	2.5	2.5	12.9
	250	68	169.0	-	3.0	3.0	575.0	835.0	2100	2500	NU2228E	NJ2228E	NUP2228E	-	-	153	-	166	171	182	237	-	-	2.5	2.5	15.8
	300	62	180.0	260.0	4.0	4.0	615.0	745.0	2300	2700	NU328	NJ328	NUP328	N328	NF328	156	156	176	182	198	284	284	265	3	3	21.2
	300	62	180.0	-	4.0	4.0	665.0	795.0	2100	2400	NU328E	NJ328E	NUP328E	-	-	156	-	176	182	198	284	-	-	3	3	23.2
	300	102	180.0	260.0	4.0	4.0	920.0	1250.0	2000	2300	NU2328	NJ2328	NUP2328	N2328	-	156	156	176	182	198	284	284	265	3	3	33.8
	300	102	180.0	-	4.0	4.0	1020.0	1380.0	1800	2100	NU2328E	NJ2328E	NUP2328E	-	-	156	-	176	182	198	284	-	-	3	3	38.7
	360	82	198.0	302.0	5.0	5.0	875.0	1020	1600	1900	NU428	NJ428	NUP428	N428	NF428	160	160	195	200	222	340	340	304	4	4	44.3

05 | Cylindrical Roller Bearing

Single Row Cylindrical Roller Bearings

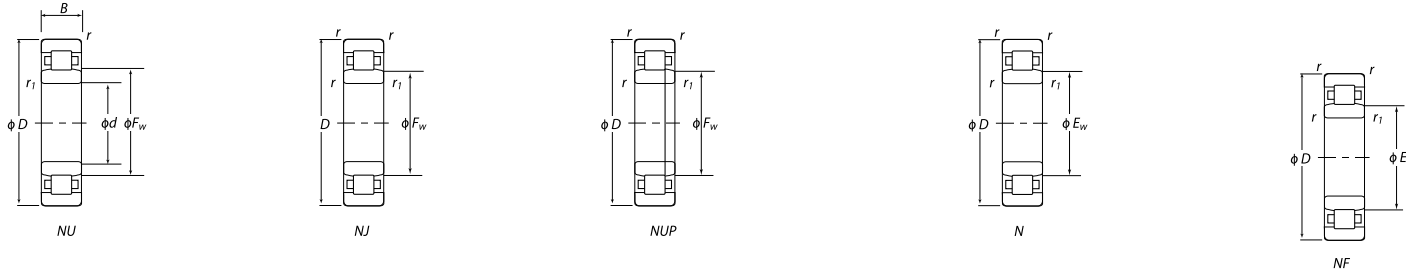

d 150 ~ 180mm

d	Main Dimension (mm)						Basic Load Rating (kN)		Limit Speed (r/min)		Bearing No.		Bearing No.			Mounting dimensions (mm)										Weight (kg)
	D	B	F _w	E _w	(r)	(r ₁)	C _r	C _{0r}	Grease Lubrication	Oil Lubrication	NU Type	NJ Type	NUP Type	N Type	NF Type	D _s Min	D ₁ Min	D ₂ Max	D ₃ Min	D ₄ Min	d _h Max	d ₁ Max	R Max	R ₁ Max		
150	225	35	169.5	205.5	2.1	1.5	202.0	294.0	3000	3500	NU1030	NJ1030	NUP1030	N1030	-	158	161	167	173	178	214	217	208	2	1.5	4.77
	270	45	182.0	238.0	3.0	3.0	375.0	490.0	2500	2900	NU230	NJ230	NUP230	N230	NF230	163	163	179	184	196	257	257	242	2.5	2.5	9.92
	270	45	182.0	-	3.0	3.0	450.0	595.0	2200	2600	NU230E	NJ230E	NUP230E	-	-	163	-	179	184	196	257	-	-	2.5	2.5	11.1
	270	73	182.0	238.0	3.0	3.0	545.0	800.0	2200	2600	NU2230	NJ2230	NUP2230	N2230	-	163	163	179	184	196	257	257	242	2.5	2.5	16.3
	270	73	182.0	-	3.0	3.0	660.0	980.0	2000	2400	NU2230E	NJ2230E	NUP2230E	-	-	163	-	179	184	196	257	-	-	2.5	2.5	19.7
	320	65	193.0	227.0	4.0	4.0	665.0	805.0	2100	2500	NU330	NJ330	NUP330	N330	NF330	166	166	190	195	213	304	304	282	3	3	25.3
	320	65	193.0	-	4.0	4.0	760.0	920.0	1900	2300	NU330E	NJ330E	NUP330E	-	-	166	-	190	195	213	304	-	-	3	3	28.4
	320	108	193.0	277.0	4.0	4.0	1020.0	1400.0	1900	2200	NU2330	NJ2330	NUP2330	N2330	-	166	166	190	195	213	304	304	282	3	3	40.6
	320	108	193.0	-	4.0	4.0	1160.0	1600.0	1700	2000	NU2330E	NJ2330E	NUP2330E	-	-	166	-	190	195	213	304	-	-	3	3	47.2
	380	85	213.0	317.0	5.0	5.0	930.0	1120.0	1500	1800	NU430	NJ430	NUP430	N430	NF430	170	170	210	216	237	360	360	319	4	4	50.8
160	240	38	180.0	220.0	2.1	1.5	238.0	340.0	2800	3300	NU1032	NJ1032	NUP1032	N1032	-	168	171	178	184	189	229	232	222	2	1.5	5.91
	290	48	195.0	255.0	3.0	3.0	430.0	570.0	2300	2700	NU232	NJ232	NUP232	N232	NF232	173	173	192	197	210	277	277	259	2.5	2.5	13.7
	290	48	195.0	-	3.0	3.0	500.0	665.0	2100	2400	NU232E	NJ232E	NUP232E	-	-	173	-	192	197	210	277	-	-	2.5	2.5	15.6
	290	80	195.0	255.0	3.0	3.0	630.0	940.0	2100	2400	NU2232	NJ2232	NUP2232	N2232	-	173	173	192	197	210	277	277	259	2.5	2.5	22.1
	290	80	193.0	-	3.0	3.0	810.0	1190.0	1900	2200	NU2232E	NJ2232E	NUP2232E	-	-	173	-	192	197	210	277	-	-	2.5	2.5	25.1
	340	68	208.0	292.0	4.0	4.0	700.0	875.0	2000	2300	NU332	NJ332	NUP332	N332	NF332	176	176	200	211	228	324	324	297	3	3	31.3
	340	68	204.0	-	4.0	4.0	860.0	1050.0	1800	2100	NU332E	NJ332E	NUP332E	-	-	176	-	200	211	228	324	-	-	3	3	34
	340	114	208.0	292.0	4.0	4.0	1070.0	1520.0	1700	2000	NU2332	NJ2332	NUP2332	N2332	-	176	176	200	211	228	324	324	297	3	3	50.5
	340	114	204.0	-	4.0	4.0	1310.0	1820.0	1600	1900	NU2332E	NJ2332E	NUP2332E	-	-	176	-	200	211	228	324	-	-	3	3	56
	170	260	42	193.0	237.0	2.1	2.1	278.0	400.0	2600	3000	NU1034	NJ1034	NUP1034	N1034	-	181	181	190	197	203	249	249	239	2	2
310		52	208.0	272.0	4.0	4.0	475.0	635.0	2200	2500	NU234	NJ234	NUP234	N234	NF234	186	186	204	211	223	294	294	277	3	3	17
310		52	207.0	-	4.0	4.0	605.0	800.0	2000	2300	NU234E	NJ234E	NUP234E	-	-	186	-	204	211	223	294	-	-	3	3	19.6
310		86	208.0	272.0	4.0	4.0	715.0	1080.0	2000	2300	NU2234	NJ2234	NUP2234	N2234	-	186	186	204	211	223	294	294	277	3	3	27.2
310		86	205.0	-	4.0	4.0	965.0	1410.0	1800	2100	NU2234E	NJ2234E	NUP2234E	-	-	186	-	204	211	223	294	-	-	3	3	31
360		72	220.0	310.0	4.0	4.0	795.0	1010.0	1800	2200	NU334	NJ334	NUP334	N334	NF334	186	186	216	223	241	344	344	315	3	3	37
360		120	220.0	310.0	4.0	4.0	1220.0	1750.0	1600	1900	NU2334	NJ2334	NUP2334	N2334	-	186	186	216	223	241	344	344	315	3	3	59.5
180		280	46	205.0	255.0	2.1	2.1	340.0	485.0	2400	2900	NU1036	NJ1036	NUP1036	N1036	-	191	191	203	209	216	269	269	257	2	2
	320	52	218.0	282.0	4.0	4.0	495.0	675.0	2000	2400	NU236	NJ236	NUP236	N236	NF236	196	196	214	221	233	304	304	287	3	3	17.7
	320	52	217.0	-	4.0	4.0	625.0	850.0	1800	2200	NU236E	NJ236E	NUP236E	-	-	196	-	214	221	233	304	-	-	3	3	20.4
	320	86	218.0	282.0	4.0	4.0	625.0	850.0	1800	2200	NU2236	NJ2236	NUP2236	N2236	-	196	196	214	221	233	304	304	287	3	3	28.4
	320	86	215.0	-	4.0	4.0	1010.0	1150.0	1600	1900	NU2236E	NJ2236E	NUP2236E	-	-	196	-	214	221	233	304	-	-	3	3	31.9
	380	75	232.0	328.0	4.0	4.0	905.0	1150.0	1700	200	NU336	NJ336	NUP336	N336	NF336	196	196	227	235	255	364	364	333	3	3	44.2
	380	126	232.0	328.0	4.0	4.0	1380.0	1990.0	1500	1800	NU2336	NJ2336	NUP2336	N2336	-	196	196	227	235	255	364	364	333	3	3	69.5

05 | Cylindrical Roller Bearing

Single Row Cylindrical Roller Bearings

d 190 ~ 200mm

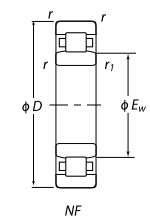
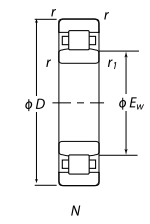
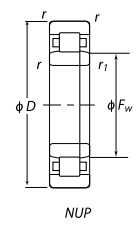
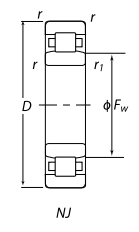
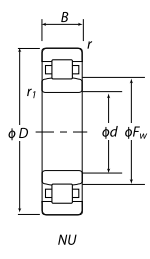

d	Main Dimension (mm)						Basic Load Rating (kN)		Limit Speed (r/min)		Bearing No.		Bearing No.			Mounting dimensions (mm)										Weight (kg)
	D	B	F _w	E _w	(r)	(r ₁)	C _r	C _{or}	Grease Lubrication	Oil Lubrication	NU Type	NJ Type	NUP Type	N Type	NF Type	D ₂ Min	D ₁ Min	D ₂ Max	D ₃ Min	D ₄ Min	d _h Max	d ₁ Max	d ₁ Min	R Max	R ₁ Max	
190	290	46	215.0	265.0	2.1	2.1	350.0	510.0	2300	2700	NU1038	NJ1038	NUP1038	N1038	-	201	201	213	219	226	279	279	267	2	2	10.7
	340	55	231.0	299.0	4.0	4.0	555.0	770.0	1900	2200	NU238	NJ238	NUP238	N238	NF238	206	206	227	234	247	324	324	304	3	3	21.3
	340	55	230.0	-	4.0	4.0	695.0	955.0	1700	2000	NU238E	NJ238E	NUP238E	-	-	206	-	227	234	247	324	-	-	3	3	24.2
	340	92	231.0	299.0	4.0	4.0	830.0	1290.0	1700	2000	NU2238	NJ2238	NUP2238	N2238	-	206	206	227	234	247	324	324	304	3	3	34.4
	340	92	228.0	-	4.0	4.0	1100.0	1670.0	1500	1800	NU2238E	NJ2238E	NUP2238E	-	-	206	-	227	234	247	324	-	-	3	3	39.5
	400	78	245.0	345.0	5.0	5.0	975.0	1260.0	1600	1900	NU338	NJ338	NUP338	N338	NF338	210	210	240	248	268	380	380	351	4	4	80.5
	400	132	245.0	345.0	5.0	5.0	1520.0	2220.0	1400	1700	NU2338	NJ2338	NUP2338	N2338	-	210	210	240	248	268	380	380	351	4	4	80.5
	200	310	51	229.0	281.0	2.1	2.1	390.0	580.0	2200	2600	NU1040	NJ1040	NUP1040	N1040	-	211	211	226	233	241	299	299	283	2	2
360		58	244.0	316.0	4.0	4.0	620.0	865.0	1800	2100	NU240	NJ240	NUP240	N240	NF240	216	216	240	247	261	344	344	321	3	3	25.3
360		58	243.0	-	4.0	4.0	765.0	1060.0	1600	1900	NU240E	NJ240E	NUP240E	-	-	216	-	240	247	261	344	-	-	3	3	28.1
360		98	244.0	316.0	4.0	4.0	620.0	865.0	1600	1900	NU2240	NJ2240	NUP2240	N2240	-	216	216	240	247	261	344	344	321	3	3	41.3
360		98	241.0	-	4.0	4.0	1220.0	1870	1500	1700	NU2240E	NJ2240E	NUP2240E	-	-	216	-	240	247	261	344	-	-	3	3	47.8
420		80	260.0	360.0	5.0	5.0	975.0	1270.0	1500	1800	NU340	NJ340	NUP340	N340	NF340	220	220	254	263	283	400	400	366	4	4	55.8
420		138	260.0	360.0	5.0	5.0	1510.0	2240.0	1400	1600	NU2340	NJ2340	NUP2340	N2340	-	220	220	254	263	283	400	400	366	4	4	92.6

Tapered roller bearings have tapered surfaces whose apexes converge at a common point on the bearing axis. This type of bearing is suitable for applications involving heavy or impact loading.

Single Row Tapered Roller Bearings

Single row tapered roller bearings are able to carry axial and radial load in one direction simultaneously.

Tapered Roller Bearings



06 | Tapered Roller Bearing

Taper Roller Bearing

Taper roller bearings are mainly used to bear radial and axial combined loading (mainly radial), large taper angle taper roller bearing can be used to bear radial and axial combined loading (mainly axial). These bearings are separate type bearings, whose inner race components (including taper roller and retainer) and outer space can be mounted respectively. During mounting and use, the radial clearance and axial clearance of the bearings can be adjusted, and pre-mounting is also possible.

1. Main structure types

1. Single-row taper roller bearing 30000

This type of bearings can limit the axial displacement of shaft and housing in one direction, and bear axial load from one direction. Affected by radial load, they will generate additional axial force, and are generally used in pairs in the two bearings of the shaft.

31300 series taper roller bearings have large contact angles (27-30), and can generate large axial load. The contact angles of the other bearings of other series are between 10-18.

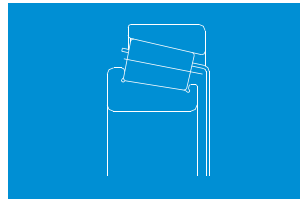

2. Permitted inclination angle

If the contact state of the roller ring is proper, it cannot only prevent the abnormal margin load of contact surface, but can also allow the inner/outer race inclination caused by alignment error, etc. The permitted inclination angles of taper roller bearings are generally 0.0005rad (1.5') for back-to-back combination, and 0.001rad (1.5') for face-to-face combination. Please contact the technical center of DPI if larger inclination angles are required.

3. Tolerance and clearance

Taper roller bearings with different kinds of tolerance grades can be manufactured as required. Customers can adjust the clearances of single row-taper roller bearings at the time of mounting as required. The radial clearance of Double row taper roller bearings can be the antecedent tolerance and clearance section according to customer requirements. Customers can adjust clearance according to related procedures during as required.

4. Dynamic equivalent radial load

Single row taper roller bearing:

$$P_r = F_r \text{ (when } F_a/F_r > e)$$

$$P_r = 0.4F_r + YF_a \text{ (when } F_a/F_r > e)$$

Single row taper roller bearings (principal dimensions may be different) are used in pairs, the additional axial force caused by radial load must be taken into account while calculating the dynamic equivalent of the bearing. The axial load magnitude of the bearing is related to its installation configuration mode and the

direction of the applied axial load.

The additional axial force of single-row taper roller bearings can be approximately calculated according to the following formula:

$$S = F_r / 2Y$$

5. Static equivalent radial load

Single row taper roller bearing

$$P_{0r} = F_r + Y_0 F_a \text{ if } P_{0r} < F_r \text{ adopt } P_{0r} = F_r$$

F_r and F_a both refer to the total load applied to single row and double row bearings.

See the bearing dimension table for the calculating coefficients e, Y, Y_1, Y_2 , and Y_0 .

6. Minimal radial load

In order to prevent the rolling between roller and raceway caused by inertial force of roller and retainer during the high speed running of the bearing, the bearing must carry certain load, and its minimum value can be estimated according to the following formula:

$$F_{rmin} = C_r$$

In the equations:

F_{rmin} :

Minimal radial load KN

C_r :

Basic dynamic load rating KN

06 | Tapered Roller Bearing

Single row taper roller bearing

Metric Series

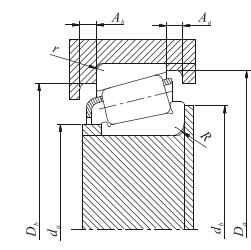
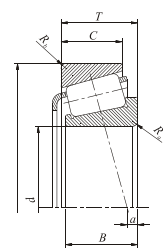

d 15~32mm

Main Dimension (mm)							Basic Load Rating (kN)		Limit Speed (r/min)		Bearing No.	Mounting dimensions (mm)							Load center mm ^a	Constant ^e	Axial load coefficient		Weight (kg)	
d	D	T	B	C	r (min)		C _r	C _{or}	Grease Lubrication	Oil Lubrication		d _a Min	d _b Max	D _a Max	D _b Min	S _a Min	S _b Min	Inner race r _a Max			Outer Ring r _b Max	Y ₁		Y ₀
					Inner race	Outer Ring																		
15	35	11.75	11	10	0.6	0.6	14.8	13.2	11000	15000	30202	23	19	30	33	2	1.5	0.6	0.6	8.2	0.32	1.9	1.0	0.056
	42	14.25	13	11	1	1	23.6	21.1	9500	13000		30302	24	22	36	38.5	2	3	1	1	9.5	0.29	2.1	1.2
17	40	13.25	12	11	1	1	20.1	19.9	9500	13000	30203	26	23	34	37.5	2	2	1	1	9.7	0.35	1.7	0.96	0.079
	40	17.25	16	14	1	1	22.7	23.3	9500	13000	32203	26	22	34	37.5	2	3	1	1	11.0	0.29	2.1	1.1	0.105
	47	15.25	14	12	1	1	29.2	26.7	8500	12000	30303	26	24	41	43	2	3	1	1	10.4	0.29	2.1	1.2	0.133
	47	20.25	19	16	1	1	36.6	35.9	8500	11000	32303	23	24	41	43	2	4	1	1	12.2	0.29	2.1	1.1	0.174
20	42	15	15	12	0.6	0.6	24.6	27.4	9000	12000	32004	28	24	37	40	3	3	0.6	0.6	10.6	0.37	1.6	0.88	0.102
	47	15.25	14	12	1	1	27.9	28.5	8000	11000	30204	29	27	41	44	2	3	1	1	11.0	0.35	1.7	0.96	0.124
	47	19.25	18	15	1	1	31.5	33.5	8000	10000	32204	29	26	41	44	2	4	1	1	12.7	0.35	1.7	0.95	0.158
	52	16.25	15	13	1.5	1.5	35	47.5	7500	10000	30304	31	27	44	47.5	2	3	2.0	1.5	11.6	0.30	2	1.1	0.171
	52	22.25	21	18	1.5	1.5	45.5	29.4	8000	11000	32304	33	26	43	48	3	4	1.5	1.5	13.9	0.30	2	1.1	0.204
22	44	15	15	11.5	0.6	0.6	25.6	30.5	8500	11000	320/22	30	27	39	42	3	3.5	0.6	0.6	11.1	0.40	1.5	0.83	0.103
	50	15.25	14	12	1	1	29.2	40.5	7500	10000	302/22	31	29	44	47	2	3	1	1	11.6	0.37	1.6	0.9	0.139
	50	19.25	18	15	1	1	36.5	33	7500	11000	322/22	31	28	44	47	2	4	1	1	13.0	0.49	1.6	0.89	0.180
25	47	15	15	11.5	0.6	0.6	27.4	38	8300	11000	32005	33	30	42	45	3	3.5	0.6	0.6	11.8	0.43	1.4	0.77	0.118
	47	17	17	14	0.6	0.6	31	35	8000	11000	33005	33	29	42	44	3	3	0.6	0.6	11.0	0.29	2.1	1.1	0.131
	52	16.25	15	13	1	1	32	43.5	7000	9000	30205	34	31	46	48.5	2	3	1	1	12.7	0.38	1.6	0.88	0.159
	52	19.25	18	15	1	1	38.5	56.5	7000	10000	32205	34	30	46	49	2	4	1	1	13.7	0.39	1.5	0.85	0.186
	52	22	22	18	1	1	47.5	56.5	7900	10000	33205	34	29	46	49.5	4	4	1	1	14.1	0.35	1.7	0.94	0.225
	62	18.25	17	15	1.5	1.5	47.5	46	6300	8500	30305	36	34	54	57	2	3	1.5	1.5	13.2	0.30	2	1.1	0.271
	62	18.25	17	13	1.5	1.5	38	40	5700	8000	31305	34	32	47	59	3	5	1.5	1.5	19.1	0.81	0.74	0.41	0.260
	62	25.25	24	20	1.5	1.5	62.5	66	6300	8000	32305	38	32	53	59	3	5	1.5	1.5	15.6	0.30	2	1.1	0.365
28	52	16	16	12	1	1	32	39	7100	9500	320/28	37	33	46	50	3	4	1	1	12.8	0.43	1.4	0.77	0.146
	58	17.25	16	14	1	1	39.5	41.5	6300	9000	302/28	37	34	52	55	2	3	1	1	13.2	0.35	1.7	0.93	0.203
	68	19.75	18	15	1.5	1.5	55	55.5	6000	8000	303/28	39	37	59	61	2	4.5	1.5	1.5	14.5	0.31	1.9	1.1	0.341
30	55	17	17	13	1	1	36	44.5	6700	9000	32006	39	35	49	53	3	4	1	1	13.5	0.43	1.4	0.77	0.170
	62	17.25	16	14	1	1	43	47.5	6000	8000	30206	39	37	56	58	2	3	1	1	13.9	0.38	1.6	0.88	0.245
	62	21.5	20	17	1	1	52	60	6000	8500	32206	39	36	56	58.5	2	4	1	1	15.4	0.38	1.6	0.88	0.285
	62	25	25	19.5	1	1	66.5	79.5	6000	8000	33206	39	35	56	59.5	5	5.5	1	1	16.1	0.34	1.8	0.97	0.355
	72	20.75	19	16	1.5	1.5	59.5	60	5300	7500	30306	41	40	63	66	3	4.5	1.5	1.5	15.1	0.32	1.9	1	0.408
	72	20.75	19	14	1.5	1.5	47.3	50	5000	6700	31306	40	37	55	68	3	6.5	1.5	1.5	22.3	0.81	0.74	0.41	0.378
	72	28.75	27	23	1.5	1.5	80	88.5	5600	7000	32306	43	36	63	68	3	5.5	1.5	1.5	18.0	0.32	1.6	0.88	0.575
32	58	17	17	13	1	1	37.5	47	6000	8500	320/32	41	37	52	55	3	4	1	1	14.2	0.45	1.3	0.73	0.191
	65	18.25	17	15	1	1	48.5	54	5600	8000	302/32	41	39	59	61	3	3	1	1	14.7	0.37	1.6	0.88	0.275
	65	22.25	21	18	1	1	56	65	6000	8000	322/32	41	38	59	61	3	4	1	1	15.9	0.37	1.6	0.88	0.336
	65	26	26	20.5	1	1	70	86.5	5600	8000	332/32	41	38	59	62	5	5.5	1	1	17.0	0.35	1.7	0.95	0.400

06 | Tapered Roller Bearing

Single row taper roller bearing

Metric Series

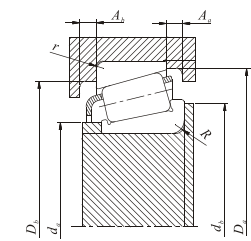
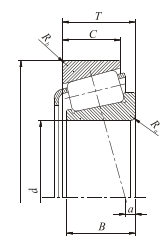

d 35~55mm

d	Main Dimension (mm)					Basic Load Rating (kN)		Limit Speed (r/min)		Bearing No.	Mounting dimensions (mm)						Load center mm ^a	Constant e	Axial load coefficient		Weight (kg)			
	D	T	B	C	r (min)	C _r	C _{or}	Grease Lubrication	Oil Lubrication		d _a Min	d _b Max	D _a Max	D _b Min	S _a Min	S _b Min			Inner race r _a Max	Outer Ring r _b Max		Y ₁	Y ₀	
35	62	18	18	14	1	1	43.5	55.5	5600	8000	32007	44	40	56	60	4	4	1	1	15.0	0.45	1.3	0.73	0.223
	62	21	21	17	1	1	49	65	5600	8000	33007	44	40	56	59	4	4	1	1	14.1	0.31	2	1.1	0.267
	72	18.25	17	15	1.5	1.5	54	59.5	5300	7100	30207	46	43	63	67	3	3	1.5	1.5	15.0	0.38	1.6	0.88	0.345
	72	24.25	23	19	1.5	1.5	70.5	83.5	5300	7100	32207	46	42	63	67.5	3	5	1.5	1.5	17.9	0.38	1.6	0.88	0.458
	72	28	28	22	1.5	1.5	86.5	108	5300	7100	33207	46	41	63	68	5	6	1.5	1.5	18.3	0.35	1.7	0.93	0.540
	80	22.75	21	18	2	1.5	76	79	4800	6700	30307	47	45	71	74	3	4.5	2	1.5	16.7	0.32	1.9	1	0.513
	80	22.75	21	15	2	1.5	62	68	4300	6000	31307	51	44	71	77	3	7.5	2	1.5	25.2	0.83	0.73	0.4	0.520
	80	32.75	31	25	2	1.5	99	111	5000	6700	32307	49	43	71	74	3	7.5	2	1.5	20.7	0.32	1.9	1	0.760
40	62	15	15	12	0.6	0.6	34	47	5600	7500	32908	48	44	57	59	3	3	0.6	0.6	11.5	0.29	2.1	1.1	0.163
	68	19	19	14.5	1	1	52.5	71	5300	7100	32008	49	45	62	65.5	4	4.5	1	1	15.0	0.38	1.6	0.87	0.280
	80	19.75	18	16	1.5	1.5	63.5	70	4800	6300	30208	51	48	71	7	3	3.5	1.5	1.5	16.6	0.38	1.6	0.88	0.438
	80	24.75	23	19	1.5	1.5	74	90.5	4500	6300	32208	51	47	71	76	3	5.5	1.5	1.5	18.9	0.38	1.6	0.88	0.559
	90	25.25	23	20	2	1.5	90.5	101	4300	5600	30308	52	52	81	82	3	5	2	1.5	19.5	0.35	1.7	0.96	0.761
	90	25.25	23	17	2	1.5	80	89.5	4000	5300	31308	56	50	81	87	3	8	2	1.5	20.8	0.36	1.7	0.9	0.726
	90	35.25	33	27	2	1.5	120	145	4500	6000	32308	54	50	81	82	3	8	2	1.5	23.4	0.35	1.7	0.96	1.045
45	68	15	15	12	0.6	0.6	34.5	50.5	5000	6700	32909	53	50	63	64	3	3	0.6	0.6	12.3	0.32	1.9	7	0.187
	75	20	20	15.5	1	1	60	83	4500	6300	32009	54	51	69	72	4	4.5	1	1	16.6	0.39	1.5	0.84	1.354
	85	20.75	19	16	1.5	1.5	68.5	79.5	4300	6000	30209	56	53	76	80	3	4.5	1.5	1.5	18.3	0.41	1.5	0.81	0.506
	85	24.75	23	19	1.5	1.5	83	102	4300	6000	32209	56	53	76	81	3	5.5	1.5	1.5	20.1	0.41	1.5	0.81	0.602
	100	27.25	25	22	2	1.5	112	127	3800	5300	30309	57	58	91	93	3	5	2	1.5	21.1	0.35	1.7	0.96	1.008
	100	27.25	25	18	2	1.5	95.5	109	4000	5000	31309	61	57	91	96	3	9	2	1.5	31.5	0.83	0.73	0.40	0.958
	100	38.25	36	30	2	1.5	144	177	3800	5300	32309	59	56	91	93	3	8	2	1.5	25.0	0.35	1.7	0.96	1.417
50	72	15	15	12	0.6	0.6	36	54	4500	6300	32910	58	54	67	69	3	3	0.6	0.6	13.5	0.34	1.8	0.97	0.192
	80	20	20	15.5	1	1	61	87	4300	6000	32010	59	56	74	77	4	4.5	1	1	17.9	0.42	1.4	0.78	0.310
	90	21.75	20	17	1.5	1.5	76	91.5	4000	5300	30210	61	58	81	85	3	4.5	1.5	1.5	19.6	0.42	1.4	0.79	0.592
	90	24.75	23	19	1.5	1.5	87.5	109	4000	5300	32210	61	57	81	86	3	5.5	1.5	1.5	21.0	0.42	1.4	0.79	0.618
	110	29.25	27	23	2.5	2	130	148	3400	4800	30310	65	65	100	102	3	6	2	2	23.1	0.35	1.7	0.96	1.250
	110	29.25	27	19	2.5	2	106	120	3800	4800	31310	62	60	100	104	4	10	2	2	34.2	0.83	0.73	0.40	1.254
	110	42.25	40	33	2.5	2	176	220	3600	4800	32310	68	62	100	102	3	9	2	2	27.9	0.35	1.7	0.96	1.885
55	90	23	23	17.5	1.5	1.5	81.5	117	3800	5300	32011	66	62	81	86	4	5.5	1.5	1.5	19.7	0.41	1.5	0.81	0.530
	100	22.75	21	18	2	1.5	94.5	113	3600	5000	30211	67	64	91	94	4	4.5	2	1.5	20.9	0.41	1.5	0.81	0.739
	100	26.75	25	21	2	1.5	110	137	3600	5000	32211	67	63	91	95	4	5.5	2	1.5	22.7	0.41	1.5	0.81	0.915
	120	31.5	29	25	2.5	2	150	171	3200	4300	30311	70	71	110	111	4	6.5	2	2	34.6	0.35	1.7	0.96	0.628
	120	31.5	29	21	2.5	2	121	137	3400	4300	31311	68	65	110	113	4	10.5	2	2	37.0	0.83	0.73	0.40	1.576
	120	45.5	43	35	2.5	2	204	258	3200	4300	32311	73	67	110	111	4	10.5	2	2	29.9	0.35	1.7	0.96	2.390

06 | Tapered Roller Bearing

Single row taper roller bearing

Metric Series

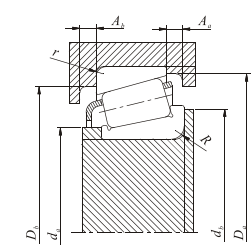
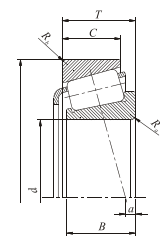

d 60~85mm

d	Main Dimension (mm)					Basic Load Rating (kN)		Limit Speed (r/min)		Bearing No.	Mounting dimensions (mm)						Load center mm ^a	Constant ^e	Axial load coefficient		Weight (kg)			
	D	T	B	C	r (min)		C _r	C _{0r}	Grease Lubrication		Oil Lubrication	d _a Min	d _b Max	D _a Max	D _b Min	S _a Min			S _b Min	Inner race r _a Max		Outer Ring r _b Max	Y ₁	Y ₀
	Inner race	Outer Ring																						
60	95	23	23	17.5	1.5	1.5	85.5	127	3600	5000	32012 30212 32212 30312 31312 32312	71	66	86	91	4	5.5	1.5	1.5	20.9	0.43	1.4	0.77	0.560
	110	23.75	22	19	2	1.5	104	123	3400	4500		72	69	101	103	4	4.5	2	1.5	22.0	0.41	1.5	0.81	0.934
	110	29.75	28	24	2	1.5	131	167	3400	4500		72	68	101	104	4	5.5	2	1.5	24.1	0.41	1.5	0.81	1.197
	130	33.5	31	26	3	2.5	174	201	300	4000		78	77	118	120	4	7.5	2.5	2	26.0	0.35	1.7	0.96	1.940
	130	33.5	31	22	3	2.5	145	166	2600	3600		84	74	118	125	4	11.5	2.5	2	40.3	0.83	0.73	0.40	1.896
	130	48.5	46	37	3	2.5	233	295	3000	4000		81	74	118	120	4	11.5	2.5	2	31.4	0.35	1.7	0.96	2.880
65	100	23	23	17.5	1.5	1.5	86.5	132	3400	4500	32013 30213 32213 30313 31313 32313	76	71	91	97	4	5.5	1.5	1.5	22.4	0.46	1.3	0.72	0.630
	120	24.75	23	20	2	1.5	122	151	3000	4000		77	78	111	113	4	4.5	2	1.5	23.8	0.41	1.5	0.81	1.132
	120	32.75	31	27	2	1.5	157	202	3000	4000		77	75	111	115	4	5.5	2	1.5	27.1	0.41	1.5	0.81	1.580
	140	36	33	28	3	2.5	200	233	2600	3600		83	83	128	130	4	8	2.5	2	27.9	0.35	1.7	0.96	2.629
	140	36	33	23	3	2.5	173	205	2800	3600		89	80	128	133	4	13	2.5	2	43.2	0.83	0.73	0.4	2.426
	140	51	48	39	3	2.5	267	340	2800	3800		86	80	128	130	4	12	2.5	2	34.0	0.35	1.7	0.96	3.609
70	110	25	25	19	1.5	1.5	104	158	3200	4300	32014 30214 32214 30314 31314 32314	81	77	101	105	5	6	1.5	1.5	23.7	0.43	1.4	0.76	0.850
	125	26.25	24	21	2	1.5	132	163	2800	4000		82	81	116	118	4	5	2	1.5	25.6	0.42	1.4	0.79	1.296
	125	33.25	31	27	2	1.5	157	205	2800	4000		82	80	116	119	4	6	2	1.5	28.6	0.42	1.4	0.79	1.620
	150	38	35	30	3	2.5	227	268	2400	3400		88	89	138	140	4	8	2.5	2	28.6	0.35	1.7	0.96	3.170
	150	38	35	25	3	2.5	192	229	2600	3400		94	85	138	142	4	13	2.5	2	45.7	0.83	0.73	0.4	2.935
	150	54	51	42	3	2.5	300	390	2600	3400		91	86	138	140	4	12	2.5	2	36.0	0.35	1.7	0.96	4.346
75	115	25	25	19	1.5	1.5	109	171	3000	4000	32015 30215 32215 30315 31315 32315	86	82	106	110	5	6	1.5	1.5	25.1	0.46	1.3	0.72	0.880
	130	27.25	25	22	2	1.5	143	182	2800	3800		87	85	121	124	4	5	2	1.5	27.0	0.44	1.4	0.76	1.384
	130	33.25	31	27	2	1.5	143	182	2800	3800		87	84	121	125	4	6	2	1.5	29.8	0.44	1.4	0.76	1.765
	160	40	37	31	3	2.5	253	300	2400	3200		93	95	148	149	4	9	2.5	2	31.8	0.35	1.7	0.96	3.542
	160	40	37	26	3	2.5	211	251	2200	3000		99	91	148	152	6	14	2.5	2	48.7	0.83	0.73	0.4	3.469
	160	58	55	45	3	2.5	340	445	2400	3200		96	91	148	149	4	13	2.5	2	38.9	0.35	1.7	0.96	5.316
80	125	29	29	22	1.5	1.5	140	222	2800	3600	32016 30216 32216 30316 31316 32316	91	89	116	120	6	7	1.5	1.5	26.9	0.42	1.4	0.78	1.180
	140	28.25	26	22	2.5	2	157	195	2600	3400		95	91	130	132	4	6	2	2	28.1	0.42	1.4	0.79	1.650
	140	35.25	33	28	2.5	2	192	254	2600	3400		95	90	130	134	4	7	2	2	30.6	0.42	1.4	0.79	2.162
	170	42.5	39	33	3	2.5	276	330	2200	3000		98	102	158	159	4	9.5	2.5	2	34.0	0.35	1.7	0.96	4.486
	170	42.5	39	27	3	2.5	235	285	2000	2800		104	97	158	159	6	15.5	2.5	2	51.8	0.83	0.73	0.4	4.065
	170	61.5	58	48	3	2.5	385	505	2200	3000		101	98	158	159	4	13.5	2.5	2	41.3	0.35	1.7	0.96	6.390
85	130	29	29	22	1.5	1.5	143	231	2600	3600	32017 30217 32217 30317 31317 32317	96	94	121	125	6	7	1.5	1.5	28.2	0.44	1.4	0.75	1.250
	150	30.5	28	24	2.5	2	184	233	2400	3200		100	97	140	141	5	6.5	2	2	30.3	0.42	1.4	0.79	2.060
	150	38.5	36	30	2.5	2	210	277	2400	3200		100	96	140	142	5	8.5	2	2	33.8	0.42	1.4	0.79	2.670
	180	44.5	41	34	4	3	310	375	2000	2800		106	108	166	167	5	10.5	3	2.5	35.7	0.35	1.7	0.96	5.305
	180	44.5	41	28	4	3	261	315	2000	2600		113	103	166	169	6	16.5	3	2.5	55.2	0.83	1.74	0.96	4.881
	180	63.5	60	49	4	3	410	535	2000	2800		110	104	166	167	5	14.5	3	2.5	43.5	0.35	1.7	0.96	7.302

06 | Tapered Roller Bearing

Single row taper roller bearing

Metric Series

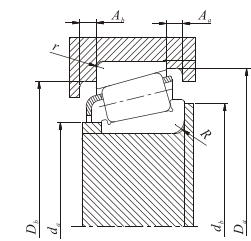
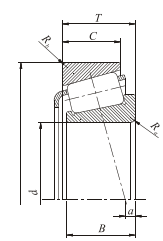

d 90~120mm

d	Main Dimension (mm)					Basic Load Rating (kN)		Limit Speed (r/min)		Bearing No.	Mounting dimensions (mm)						Load center mm a	Constant e	Axial load coefficient		Weight (kg)			
	D	T	B	C	r (min)		C _r	C _{0r}	Grease Lubrication		Oil Lubrication	d _a Min	d _b Max	D _a Max	D _b Min	S _a Min			S _b Min	Inner race r _a Max		Outer Ring r _a Max	Y ₁	Y ₀
					Inner race	Outer Ring																		
90	140	32	32	24	2	1.5	170	273	2400	3200	32018 30218 32218 30318 31318 32318	102	99	131	134	6	8	2	1.5	29.7	0.42	1.4	0.78	1.700
	160	32.5	30	26	2.5	2	201	256	2200	3000		105	103	150	150	5	6.5	2	2	31.7	0.42	1.4	0.79	2.558
	160	42.5	40	34	2.5	2	256	350	2200	3000		105	102	150	152	5	8.5	2	2	36.1	0.42	1.4	0.79	3.265
	190	46.5	43	36	4	3	305	360	1900	2600		111	115	176	177	5	10.5	3	2.5	37.6	0.35	1.7	0.95	6.144
	190	46.5	43	30	4	3	265	315	1800	2400		118	110	176	179	6	16.5	3	2.5	58.5	0.83	0.73	0.4	5.511
	190	67.5	64	53	4	3	450	590	2000	2600		115	109	176	177	5	14.5	3	2.5	46.5	0.35	1.7	0.96	8.568
95	145	32	32	24	2	1.5	173	283	2400	3200	32019 30219 32219 30319 31319 32319	107	104	136	140	6	8	2	1.5	31.2	0.44	1.4	0.75	1.700
	170	34.5	32	27	3	2.5	223	286	2200	2800		113	110	158	159	5	7.5	2.5	2	33.7	0.42	1.4	0.79	3.269
	170	45.5	43	37	3	2.5	289	400	2200	2800		113	108	158	161	5	8.5	2.5	2	39.3	0.42	1.4	0.79	4.216
	200	49.5	45	38	4	3	335	400	1900	2400		116	119	186	184	5	11.5	3	2.5	39.7	0.35	1.7	0.95	6.546
	200	49.5	45	32	4	3	310	375	1800	2400		123	115	186	187	6	17.5	3	2.5	61.9	0.83	0.73	0.4	6.635
	200	71.5	67	55	4	3	460	600	1900	2400		120	114	186	184	5	16.5	3	2.5	48.5	0.35	1.7	0.95	9.645
100	150	32	32	24	2	1.5	176	294	2200	3000	32020 30220 32220 30320 31320 32320	112	109	141	144	6	8	2	1.5	32.5	0.46	1.3	0.72	1.947
	180	37	34	29	3	2.5	255	330	2000	2600		118	116	168	168	5	8	2.5	2	36.1	0.42	1.4	0.79	3.976
	180	49	46	39	3	2.5	325	450	2000	2600		118	115	168	171	5	10	2.5	2	41.5	0.42	1.4	0.79	5.213
	215	51.5	47	39	4	3	365	435	1700	2400		121	128	201	196	5	12.5	3	2.5	41.7	0.35	1.7	0.95	8.690
	215	56.5	51	35	4	3	350	435	1600	2000		114	121	201	202	7	21.5	3	2.5	69.0	0.83	0.73	0.4	8.600
	215	77.5	73	60	4	3	565	755	1700	2400		125	125	201	200	5	17.5	3	2.5	53.2	0.35	1.7	0.96	12.96
105	160	35	35	26	2.5	2	204	340	2000	2800	32021 30221 32221 30321 31321 32321	120	115	150	154	6	9	2	2	34.3	0.44	1.4	0.74	2.500
	190	39	36	30	3	2.5	280	365	1900	2600		123	123	178	177	6	9	2.5	2	38.1	0.42	1.4	0.79	4.510
	190	53	50	43	3	2.5	360	510	1900	2600		123	120	178	180	5	10	2.5	2	44.8	0.42	1.4	0.79	6.260
	225	53.5	49	41	4	3	395	470	1600	2200		126	134	211	206	6	12.5	3	2.5	43.5	0.35	1.7	0.95	9.120
	225	58	53	36	4	3	380	470	1700	2300		119	126	211	211	7	22	3	2.5	71.5	0.83	0.73	0.4	9.680
	225	81.5	77	63	4	3	585	780	1700	2200		130	129	211	209	6	18.5	3	2.5	55.0	0.35	1.7	0.95	14.21
110	170	38	38	29	2.5	2	236	390	2000	2600	32022 30222 32222 30322 31322 32322	125	121	160	163	7	9	2	2	35.9	0.43	1.4	0.77	3.100
	200	41	38	32	3	2.5	315	420	1800	2400		128	129	188	187	6	9	2.5	2	40.1	0.42	1.4	0.79	5.270
	200	56	53	46	3	2.5	400	565	1800	2400		128	127	188	190	5	10	2.5	2	47.2	0.42	1.4	0.79	7.360
	240	54.5	50	42	4	3	485	595	1500	2000		131	143	226	220	6	12.5	3	2.5	45.1	0.35	1.7	0.96	11.45
	240	63	57	38	4	3	430	563	1400	1900		124	135	226	224	7	25	3	2.5	76.0	0.83	0.73	0.4	12.20
	240	84.5	80	65	4	3	675	910	1500	2000		135	139	226	222	6	19.5	3	2.5	58.5	0.35	1.7	0.96	18.78
120	180	38	38	29	2.5	2	242	405	1800	2400	32024 30224 32224 30324 31324 32324	135	131	170	173	7	9	2	2	39.7	0.46	1.3	0.72	3.100
	215	43.5	40	34	3	2.5	335	450	1600	2200		138	141	203	201	6	9.5	2.5	2	44.4	0.44	1.4	0.76	6.125
	215	61.5	58	50	3	2.5	440	635	1600	2200		138	137	203	204	6	11.5	2.5	2	52.0	0.44	1.4	0.76	9.169
	260	59.5	55	46	4	3	535	655	1400	1900		141	154	246	237	6	13.5	3	2.5	50.0	0.35	1.7	0.96	13.7
	260	68	62	42	4	3	526	665	1300	1800		134	145	246	244	9	26	3	2.5	82.5	0.83	0.73	0.4	15.4
	260	90.5	86	69	4	3	770	1060	1400	1900		145	149	246	239	6	21.5	3	2.5	62.4	0.35	1.7	0.96	21.7

06 | Tapered Roller Bearing

Single row taper roller bearing

Metric Series

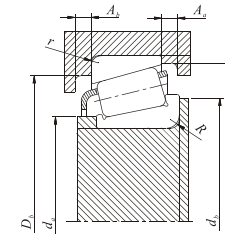
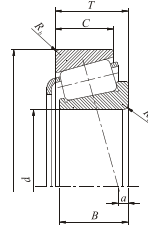

d 130~200mm

d	Main Dimension (mm)					Basic Load Rating (kN)		Limit Speed (r/min)		Bearing No.	Mounting dimensions (mm)						Load center mm a	Constant e	Axial load coefficient		Weight (kg)					
	D	T	B	C	r (min)	C _r	C _{0r}	Grease Lubrication	Oil Lubrication		d _a Min	d _b Max	D _a Max	D _b Min	S _a Min	S _b Min			Inner race r _a Max	Outer Ring r _b Max		Y ₁	Y ₀			
130	200	45	45	34	2.5	2	320	535	1600	2200	32026 30226 32226 30326 31326 32326	145	144	190	192	8	11	2	2	43.9	0.43	1.4	0.76	5.06		
	230	43.75	40	34	4	3	375	505	1500	2000		151	151	216	217	7	9.5	3	2.5	45.8	0.44	1.4	0.76	7.24		
	230	67.75	64	54	4	3	530	790	1500	2000		151	147	216	219	7	13.5	3	2.5	56.9	0.44	1.4	0.76	11.37		
	280	63.75	58	49	5	4	545	675	1300	1800		157	168	262	255	8	14.5	4	3	53.9	0.36	1.7	0.92	17.1		
	280	72	66	44	5	4	589	748	1200	1600		148	152	262	261	9	28	4	3	87.5	0.83	0.73	0.4	18.9		
	280	98.75	93	78	5	4	830	1150	1300	1800		162	165	262	263	8	20.5	4	3	69.2	0.36	1.7	0.92	26.6		
140	210	45	45	34	2.5	2	325	555	1600	2200	32028 30228 32228 30328 31328 32328	155	152	200	202	8	11	2	2	46.6	0.46	1.3	0.72	5.21		
	250	45.75	42	36	4	3	390	515	1400	1900		161	164	236	234	7	9.5	3	2.5	48.9	0.44	1.4	0.76	8.892		
	250	71.75	68	58	4	3	610	915	1400	1900		161	159	236	238	9	13.5	3	2.5	58.9	0.40	1.5	0.82	14.68		
	300	67.75	62	53	5	4	600	740	1200	1600		167	180	282	272	9	14.5	4	3	57.4	0.36	1.7	0.92	21.7		
	300	77	70	47	5	4	674	865	1100	1500		158	165	282	280	9	30	4	3	94.0	0.83	0.73	0.4	23.3		
	300	107.75	102	85	5	4	985	1440	1200	1600		172	177	282	281	9	22.5	4	3	76.4	0.37	1.6	0.88	33.9		
150	225	48	48	36	3	2.5	375	650	1400	2000	32030 30230 32230 30330 31330 32330	168	164	213	216	8	12	2.5	2	49.8	0.46	1.3	0.72	6.2		
	270	49	45	38	4	3	435	570	1300	1700		171	176	256	251	7	11	3	2.5	50.2	0.43	1.4	0.77	10.3		
	270	77	73	60	4	3	595	900	1300	1700		171	177	256	254	8	17	3	2.5	64.0	0.40	1.5	0.82	17.4		
	320	72	65	55	5	4	690	860	1100	1500		177	193	302	292	8	17	4	3	61.4	0.36	1.7	0.92	24.4		
	320	82	75	50	5	4	763	898	980	1400		172	179	302	301	9	27	4	3	100.0	0.83	0.73	0.4	28.0		
	320	114	108	90	5	4	1120	1700	1100	1500		182	191	302	297	8	24	4	3	81.5	0.37	1.6	0.88	41.4		
160	240	51	51	38	3	2.5	425	750	1300	1800	32032 30232 32232 30332 31332 32332	178	175	228	231	8	13	2.5	2	53.0	0.46	1.3	0.72	8.0		
	290	52	48	40	4	3	470	610	1200	1600		181	192	276	272	8	12	3	2.5	55.0	0.43	1.4	0.77	12.9		
	290	84	80	67	4	3	725	1120	1200	1600		181	190	276	275	10	17	3	2.5	70.1	0.40	1.5	0.82	21.1		
	340	75	68	58	5	4	765	960	1000	1400		187	205	322	311	10	17	4	3	64.6	0.36	1.7	0.92	33.5		
	340	121	114	95	5	4	1210	1770	1000	1400		192	202	322	319	10	26	4	3	87.1	0.37	1.6	0.88	47.9		
	170	260	57	57	43	3	2.5	505	890	1200		1700	32304 30234 32234 30334 31334 32334	188	187	248	249	10	14	2.5	2	56.6	0.44	1.4	0.74	11.0
310		57	52	43	5	4	525	690	1100	1500	197	203		292	288	8	14	4	3	59.8	0.43	1.4	0.77	16.1		
310		91	86	71	5	4	835	1320	1100	1500	197	201		292	293	10	20	4	3	73.9	0.40	1.5	0.82	28.5		
360		80	72	62	5	4	845	1080	950	1300	197	221		342	332	10	18	4	3	70.1	0.37	1.6	0.90	33.4		
360		127	120	100	5	4	1370	2050	1000	1300	202	213		342	337	10	27	4	3	91.3	0.37	1.6	0.88	56.8		
180		280	64	64	48	3	2.5	640	1130	1200	1600	32036 30236 32236 30336 31336 32336		198	199	268	267	10	16	2.5	2	60.4	0.42	1.42	0.78	14.1
	320	57	52	43	5	4	520	695	1100	1400	207		213	302	297	9	14	4	3	62.1	0.44	1.4	0.74	18.1		
	320	91	86	71	5	4	875	1380	1000	1400	207		211	302	305	10	20	4	3	75.2	0.40	1.5	0.82	28.2		
	380	83	75	64	5	4	935	1230	940	1300	207		233	362	345	10	19	4	3	72.4	0.36	1.7	0.92	39.7		
	380	134	126	106	5	4	1520	2290	950	1300	212		225	362	353	10	28	4	3	96.6	0.37	1.6	0.88	67		
	190	340	60	55	46	5	4	580	790	1300	1300		30238 32238 30338 32338	217	228	322	316	9	14	4	3	62.7	0.40	1.5	0.82	21.7
340		97	92	75	5	4	980	1550	1000	1300	217	223		322	323	11	22	4	3	79.0	0.40	1.5	0.82	35.7		
400		86	78	65	6	5	1010	1340	850	1200	223	248		378	366	11	21	5	4	76.1	0.36	1.7	0.92	46.2		
400		140	132	109	6	5	1660	2580	850	1200	229	243		378	375	11	31	5	4	102.7	0.73	1.6	0.88	76.6		
200		360	64	58	48	5	4	645	890	900	1300	30240 32240 30340 32340		227	242	342	334	10	16	4	3	65.5	0.40	1.5	0.82	25.7
		360	104	98	82	5	4	1090	1750	950	1300			227	233	342	338	11	22	4	3	85.0	0.40	1.5	0.82	44.7
	420	89	80	67	6	5	1030	1390	850	1200	233		253	398	368	11	22	5	4	81.4	0.37	1.6	0.88	53.5		
	420	146	138	115	6	5	1820	2870	800	1100	239		253	398	392	11	31	5	4	106.7	0.37	1.6	0.88	91		

06 | Tapered Roller Bearing

Single row taper roller bearing

Inch Series

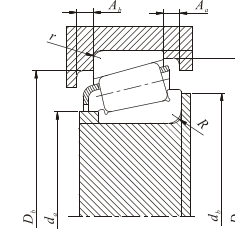
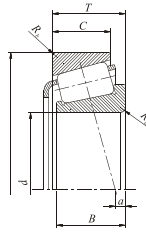

d 15.875~25.400mm

d	Main Dimension (mm)					(R_s) (R_r) min	Basic Load Rating (kN)		Limit Speed (r/min)		Bearing No.		Load center mm <i>a</i> ¹⁾	Constant <i>e</i>	Axial load coefficient		Mounting dimensions (mm)						Weight (kg)
	D	T	B	C	C_1		C_{Or}	Grease Lubrication	Oil Lubrication	Cone	Cup	Y_1			Y_0	Shaft		Bearing housing			Retainer		
	d_a	d_b	RMax	D_a												D_b	rMax	A_a	A_b				
15.875	42.862	14.288	14.288	9.525	17.4	17.4	10,000	14,000	11590	11520	1.3	0.70	0.85	0.47	22.5	24.5	1.5	39.5	34.5	1.5	4.5	2.0	0.10
16.000	47.000	21.000	21.000	16.000	37.1	39.3	9,800	13,000	HM81649	HM81610	6.1	0.55	1.10	0.60	23.0	27.5	1.0	43.0	37.5	1.0	5.0	3.0	0.18
17.462	39.878	13.843	14.605	10.688	22.9	23.4	11,000	14,000	LM11749	LM11710	5.1	0.29	2.00	1.10	21.5	23.0	1.3	37.0	34.0	1.3	4.0	3.0	0.08
19.050	45.237	15.494	16.637	12.065	30.6	32.0	9,400	13,000	LM11949	LM11910	5.6	0.30	2.00	1.10	23.5	25.0	1.3	41.5	39.5	1.3	4.5	3.5	0.12
	49.225	19.845	21.539	14.288	39.7	40.5	8,900	12,000	09078	09195	9.1	0.27	2.26	1.24	24.0	25.5	1.3	44.5	42.0	1.3	4.5	4.0	0.18
	49.225	21.209	19.050	17.462	39.7	40.5	8,900	12,000	09067	09196	7.4	0.27	2.26	1.24	24.0	25.5	1.3	44.5	41.5	1.5	4.5	1.0	0.19
	53.975	22.225	21.839	15.875	43.0	42.5	8,400	11,000	21075	21212	5.8	0.59	1.02	0.56	26.0	31.5	1.5	50.0	43.0	2.3	4.5	4.0	0.24
20.000	50.005	13.495	14.260	9.525	27.0	29.6	7,900	11,000	07079	07196	2.8	0.40	1.49	0.82	26.0	27.5	1.5	47.0	44.5	5.0	4.0	1.5	0.14
20.625	49.225	19.845	21.539	14.288	39.7	40.5	8,000	11,000	09081	09195	9.1	0.27	2.26	1.24	25.5	27.5	1.5	44.5	42.0	1.3	4.5	4.0	0.17
21.986	45.237	17.526	18.288	13.970	40.8	43.5	8,600	12,000	M12649	M12160	6.4	0.28	2.16	1.18	25.5	29.0	1.3	46.0	44.0	1.3	4.5	3.5	0.16
	45.974	15.494	16.637	12.065	30.2	35.3	8,900	12,000	LM12749	LM12710	5.3	0.31	1.96	1.08	26.0	27.5	1.3	42.0	39.5	1.3	4.0	3.0	0.12
22.225	50.005	15.494	16.637	12.065	30.2	35.3	8,900	12,000	LM12749	LM12711	5.3	0.31	1.96	1.08	26.0	27.5	1.3	42.5	40.0	1.3	4.0	3.0	0.12
21.225	50.005	17.526	18.288	13.970	40.8	43.5	8,500	11,000	M12648	M12610	6.4	0.28	2.16	1.19	26.5	28.5	1.3	46.0	44.0	1.3	4.5	3.5	0.17
	52.388	19.638	20.168	14.288	44.3	48.3	8,000	11,000	1380	1328	7.6	0.29	2.05	1.13	27.0	29.5	1.5	48.5	45.0	1.5	5.0	3.5	0.20
	53.975	19.368	20.168	14.288	44.3	48.3	8,000	11,000	1380	1329	7.6	0.29	2.05	1.13	27.0	29.5	1.5	49.0	46.0	1.5	5.0	3.5	0.22
	56.896	19.368	19.837	15.875	42.0	45.3	7,600	10,000	1755	1729	6.9	0.31	1.95	1.07	27.5	29.0	1.3	51.0	49.0	1.3	4.0	3.5	0.24
	57.150	22.225	22.225	17.462	51.2	55.1	7,600	10,000	1280	1220	6.9	0.35	1.73	0.95	29.0	29.5	0.8	52.0	49.0	1.5	5.5	2.5	0.28
	66.421	23.812	25.433	19.050	71.0	81.7	6,500	8,700	2684	2631	9.4	0.25	2.36	1.30	29.0	31.5	1.5	60.0	58.0	1.3	6.0	4.5	0.46
22.606	47.000	15.500	15.500	12.000	27.5	33.0	8,700	12,000	LM72489	LM72810	3.0	0.47	1.27	0.70	28.0	30.0	1.5	44.0	40.5	1.0	4.0	2.0	0.12
23.812	50.292	14.224	14.732	10.688	27.8	32.9	7,800	10,000	L44640	L44610	3.3	0.37	1.60	0.88	28.5	30.5	1.5	47.0	44.5	1.3	4.0	2.5	0.12
	56.896	19.367	19.837	15.875	42.0	45.3	7,600	10,000	1779	1729	6.9	0.31	1.95	1.07	28.5	29.5	0.8	51.0	49.0	1.3	4.0	3.5	0.24
	65.088	22.225	21.463	15.875	50.6	55.8	5,600	7,900	23092	23256	2.3	0.73	0.82	0.45	34.5	38.5	1.5	63.0	53.0	1.5	4.0	3.5	0.37
24.981	50.005	13.495	14.260	9.525	27.0	29.6	7,900	11,000	07098	07196	2.8	0.40	1.49	0.82	29.0	31.0	1.5	47.0	44.5	1.0	5.0	4.0	0.11
	62.000	16.002	16.566	14.288	40.0	44.1	6,700	8,900	17098	17244	3.6	0.38	1.57	0.86	30.5	33.0	1.5	57.0	54.0	1.5	3.5	4.5	0.25
25.000	50.005	13.495	14.260	9.525	27.0	29.6	7,900	11,000	07097	07196	2.8	0.40	1.49	0.82	29.0	31.0	1.5	47.0	44.5	1.0	5.0	4.0	0.11
25.400	50.005	13.495	14.260	9.525	27.0	29.6	7,900	11,000	07100	07196	2.8	0.40	1.49	0.82	29.5	30.5	1.0	47.0	44.5	1.0	5.0	4.0	0.11
	50.005	13.495	14.260	9.525	27.0	29.6	7900	11000	07100S	07196	2.8	0.40	1.49	0.82	29.5	31.5	1.5	47.0	44.5	1.0	5.0	4.0	0.11
	50.292	14.224	14.732	10.668	27.8	32.9	7800	10000	L44643	L44610	3.3	0.37	1.60	0.88	30.0	32.0	1.3	47.0	44.5	1.3	4.0	2.5	0.12
	51.994	15.011	14.260	12.700	27.0	29.6	7900	11000	07100	07204	2.8	0.40	1.49	0.82	29.5	30.5	1.0	48.0	45.0	1.3	3.0	2.5	0.14
	58.738	19.050	19.355	15.080	44.8	50.2	7000	9300	1986R	1932	5.8	0.33	1.82	1.00	30.5	32.5	1.2	54.0	52.0	1.2	5.0	3.5	0.24
	59.530	23.368	23.114	18.288	53.8	63.3	7200	9600	M84249	M84210	5.1	0.55	1.10	0.60	32.5	36.0	0.8	56.0	49.5	1.5	5.5	3.0	0.32
	61.912	19.050	20.638	14.288	46.8	53.9	6400	8600	15101	15243	5.8	0.35	1.71	0.94	31.5	32.5	0.8	58.0	54.0	2.0	5.0	5.0	0.29
	62.000	19.050	20.638	14.288	46.8	53.9	6400	8600	15100	15245	5.8	0.35	1.71	0.94	31.5	38.0	3.5	58.0	55.0	1.3	5.0	5.0	0.29
	63.500	19.050	20.638	14.288	46.8	53.9	6400	8600	15101	15250X	5.8	0.35	1.71	0.94	31.5	32.5	0.8	58.0	54.0	1.5	5.0	5.0	0.29

Remarks: 1.) When a is negative, it represents that the useful load center on the outer side of the bearing
2.)** represents that the inner race adopts compound fillet.

06 | Tapered Roller Bearing

Single row taper roller bearing

Inch Series

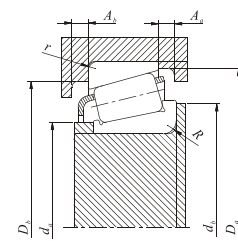
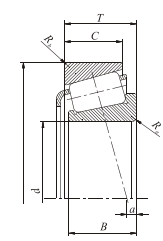

d 25.400~30.162mm

d	Main Dimension (mm)					Basic Load Rating (kN)		Limit Speed (r/min)		Bearing No.		Load center mm a ¹⁾	Constant e	Axial load coefficient		Mounting dimensions (mm)							Weight (kg)		
	D	T	B	C	(R _s) min	(R _b) min	C ₁	C _{or}	Grease Lubrication	Oil Lubrication	Cone			Cup	Y ₁	Y ₀	Shaft		Bearing housing			Retainer			
																d _s	d _b	RMax	D _s	D _b	rMax	A _s	A _b		
25.400	64.292	21.433	21.433	16.670	1.5	1.5	55.7	71.7	6400	8500	M86643	M86610			1.10	0.60	36.5	38.0	1.5	61.0	54.0	1.5	5.0	3.0	0.36
	65.088	22.225	21.463	15.875	1.5	1.5	50.6	55.8	5600	7900	23100	23256			0.82	0.45	34.5	39.0	1.5	63.0	53.0	1.5	4.0	3.5	0.36
	66.421	23.812	25.433	19.050	1.3	1.3	71.0	81.7	6500	8700	2687	2631			2.36	1.30	31.5	33.5	1.3	60.0	58.0	1.3	6.0	4.5	0.44
	68.262	22.225	22.225	17.462	0.8	1.5	59.1	70.2	6000	8000	02473	02420			1.44	0.79	33.5	34.5	0.8	63.0	59.0	1.5	5.5	3.0	0.43
	72.233	25.400	25.400	19.842	0.8	2.3	71.1	94.2	5700	7600	HM88630	HM88610			1.10	0.60	39.5	39.5	0.8	69.0	60.0	2.3	5.5	4.0	0.59
26.157	61.913	19.050	20.638	14.288	0.8	2.0	46.8	53.9	6400	8600	15103	15249			1.71	0.94	32.5	33.0	0.8	58.0	55.0	2.0	5.0	5.0	0.29
	61.999	19.050	20.638	14.288	0.8	1.3	46.8	53.9	6400	8600	15103	15245			1.71	0.94	32.5	33.0	0.8	58.0	55.0	1.3	5.0	5.0	0.29
26.162	66.421	23.812	25.433	19.050	1.5	1.3	71.0	81.7	6500	8700	2682	2631			2.36	1.30	32.0	34.5	1.5	60.0	58.0	1.3	6.0	4.5	0.43
26.988	50.292	14.244	14.732	10.688	3.5	1.3	27.8	32.9	7800	10000	L44649	L44610			1.60	0.88	31.0	37.5	3.5	47.0	44.5	1.3	4.0	2.5	0.11
	60.325	19.842	17.462	15.875	3.5	1.5	42.6	50.1	7000	9400	15580	15523			1.73	0.95	32.0	38.5	3.5	54.0	51.0	1.5	5.0	1.5	0.25
	62.000	19.050	20.638	14.288	0.8	1.3	46.8	53.9	6400	8600	15106	15245			1.71	0.94	33.0	33.5	0.8	58.0	55.0	1.3	5.0	5.0	0.28
	66.421	23.812	25.433	19.050	1.5	1.3	71.0	81.7	6500	8700	2688	2631			2.36	1.30	33.0	35.0	1.5	60.0	58.0	1.3	6.0	4.5	0.42
28.575	57.150	17.462	17.462	13.495	3.5	1.5	42.6	50.1	7000	9400	15590	15520			1.73	0.95	33.5	39.5	3.5	53.0	51.0	1.5	5.0	3.5	0.19
	57.150	19.845	19.355	15.875	3.5	1.5	44.8	50.2	7000	9300	1988	1922			1.82	1.00	33.5	39.5	3.5	53.5	51.0	1.5	5.0	2.5	0.17
	62.000	19.050	20.638	14.288	3.5	1.3	46.8	53.9	6400	8600	15112	15245			1.71	0.94	34.0	40.0	3.5	58.0	55.0	1.3	5.0	5.0	0.27
	62.000	19.050	20.638	14.288	0.8	1.3	46.8	53.9	6400	8600	15113	15245			1.71	0.94	34.0	34.5	0.8	58.0	55.0	1.3	5.0	5.0	0.27
	64.292	21.433	21.433	16.670	1.5	1.5	55.7	71.7	6400	8500	M86647	M86610			1.10	0.60	38.0	40.0	1.5	61.0	54.0	1.5	5.0	3.0	0.34
	66.421	23.812	25.433	19.050	1.3	1.3	71.0	81.7	6500	8700	2689	2631			2.36	1.30	34.0	36.0	1.3	60.0	58.0	1.3	6.0	4.5	0.41
	68.262	22.225	22.225	17.462	0.8	1.5	59.1	70.2	6000	8000	02474	02420			1.77	0.81	36.0	36.5	0.8	63.0	59.0	1.5	5.5	3.0	0.41
	72.000	19.000	18.923	15.875	1.5	1.5	54.4	60.1	5900	7800	26112	26283			1.67	0.92	35.0	37.0	1.5	65.0	62.0	1.5	4.5	3.0	0.38
	72.626	24.608	24.257	17.462	4.8	1.5	64.6	64.1	6100	8600	41125	41286			1.00	0.55	36.5	48.0	4.8	68.0	61.0	1.5	6.5	4.0	0.46
	72.626	24.608	24.608	17.462	1.5	1.5	64.6	64.1	6100	8600	41126	41286			1.00	0.55	36.5	41.5	1.5	68.0	61.0	1.5	6.5	4.0	0.46
	72.626	30.162	30.162	23.812	3.5	3.3	87.7	102.0	5800	7700	3192	3120			1.80	0.99	37.0	43.5	3.5	67.0	61.0	3.3	6.5	3.0	0.61
	72.626	30.162	30.162	23.812	1.3	3.3	87.7	102.0	5800	7400	3198	3120			1.80	0.99	37.0	39.0	1.3	67.0	61.0	3.3	6.5	3.0	0.61
	73.025	22.225	22.225	17.462	0.8	3.3	60.8	74.9	5500	7400	02872	02820			1.32	0.73	37.0	37.5	0.8	68.0	62.0	3.3	5.0	3.0	1.04
79.375	25.400	25.400	17.462	0.8	1.5	71.9	76.2	5500	7300	43112	43312			0.90	0.49	41.5	42.5	0.8	74.0	67.0	1.5	7.0	3.5	0.60	
29.000	50.292	14.224	14.224	10.668	3.5	1.3	27.7	36.2	7600	10000	L45449	L45410			1.62	0.89	33.0	39.5	3.5	48.0	44.5	1.3	4.0	3.5	0.11
29.367	66.421	23.812	23.812	19.050	3.5	1.3	71.0	81.7	6500	8700	2690	2631			2.36	1.30	35.0	41.0	3.5	60.0	58.0	1.3	6.0	4.5	0.40
29.987	62.000	16.002	16.002	14.288	1.5	1.5	40.0	44.1	6700	8900	17118	17244			1.57	0.86	34.5	37.0	1.5	57.0	54.0	1.5	3.5	4.5	0.22
	62.000	19.050	19.050	14.288	1.3	1.3	46.8	53.9	6400	8600	15117	15245			1.71	0.94	35.0	36.5	1.3	58.0	55.0	1.3	5.0	5.0	0.26
30.000	69.3012	19.845	19.845	15.875	3.5	1.3	50.6	61.7	5900	7800	14117A	14276			1.57	0.86	40.0	43.0	3.5	63.0	60.0	1.3	4.5	3.0	0.36
30.112	62.000	19.050	19.050	14.288	0.8	1.3	46.8	53.9	6400	8600	15116	15245			1.71	0.94	35.5	36.0	0.8	58.0	55.0	1.3	5.0	5.0	0.26
30.162	62.000	19.845	16.002	14.288	1.5	1.5	40.0	44.1	6700	8900	17119	17244			1.57	0.86	34.5	37.0	1.5	57.0	54.0	1.5	3.5	4.5	0.23
	64.292	19.050	21.433	16.670	1.5	1.5	55.7	71.7	6400	8500	M86649	M86610			1.10	0.60	38.2	41.0	1.5	61.0	54.0	1.5	5.0	3.0	0.33
	68.262	16.002	22.225	17.462	2.3	1.5	59.6	77.4	6000	7900	M88043	M88010			1.10	0.60	39.5	43.5	2.3	65.0	58.0	1.5	4.0	3.0	0.41

Remarks: 1.) When a is negative, it represents that the useful load center on the outer side of the bearing
2.)** represents that the inner race adopts compound fillet.

06 | Tapered Roller Bearing

Single row taper roller bearing

Inch Series

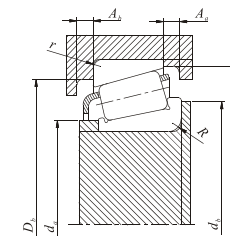
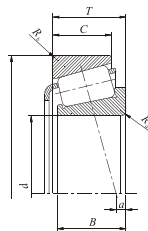

d30.213~34.980mm

d	Main Dimension (mm)					Basic Load Rating (kN)		Limit Speed (r/min)		Bearing No.		Load center mm a ¹⁾	Constant e	Axial load coefficient		Mounting dimensions (mm)						Weight (kg)			
	D	T	B	C	(R _a) min	(R _b)	C ₁	C ₂	Grease Lubrication	Oil Lubrication	Cone			Cup	Y ₁	Y ₀	Shaft			Bearing housing			Retainer		
																	d _a	d _b	R _{Max}	D _a	D _b		r _{Max}	A _a	A _b
30.213	62.000	21.433	19.050	14.288	3.5	1.3	46.8	53.9	6400	8600	15518	15245	5.8	0.35	1.71	0.94	35.5	41.5	3.5	58.0	55.0	1.3	5.0	5.0	0.26
	62.000	22.225	19.050	14.288	1.5	1.3	46.8	53.9	6400	8600	15119	15245	5.8	0.35	1.71	0.94	35.5	37.5	1.5	58.0	55.0	1.3	5.0	5.0	0.26
	62.000	19.050	19.050	14.288	0.8	1.3	46.8	53.9	6400	8600	15120	15245	5.8	0.35	1.71	0.94	35.5	36.0	0.8	58.0	55.0	1.3	5.0	5.0	0.26
30.226	69.012	19.845	19.845	15.875	0.8	3.3	50.6	61.7	5900	7800	14116	14274	4.3	0.38	1.57	0.86	36.5	38.0	0.8	63.0	59.0	3.3	4.5	3.0	0.35
31.750	58.738	14.684	14.684	10.716	1.0	1.0	29.3	35.0	6600	8900	08125	08231	1.3	0.47	1.27	0.69	36.0	37.5	1.0	55.0	52.0	1.0	4.5	3.0	0.16
	59.131	15.875	15.875	11.811	** 2)	1.3	36.5	44.6	6600	8800	LM67048	LM67010	3.0	0.41	1.46	0.80	36.0	42.5	***2)	56.0	52.0	1.3	4.5	3.5	0.17
	62.000	18.161	18.161	14.288	**	1.3	46.8	53.9	6400	8600	15123	15245	4.8	0.35	1.71	0.94	36.5	42.5	**	58.0	55.0	1.3	5.0	5.0	0.23
	62.000	19.050	19.050	14.288	3.5	1.3	46.8	53.9	6400	8600	15125	15245	5.8	0.35	1.71	0.94	36.5	42.5	3.5	58.0	55.0	1.3	5.0	5.0	0.24
	62.000	19.050	19.050	14.288	0.8	1.3	46.8	53.9	6400	8600	15126	15245	5.8	0.35	1.71	0.94	36.5	37.0	0.8	58.0	55.0	1.3	5.0	5.0	0.25
	66.421	25.400	25.400	20.638	0.8	3.3	77.5	94.4	6000	8000	2580	2520	8.6	0.27	2.19	1.21	37.5	38.5	0.8	62.0	56.9	3.3	5.5	3.0	0.39
	68.262	22.225	22.225	17.462	1.5	1.5	59.6	77.4	6000	7900	M88046	M88010	2.8	0.55	1.10	0.60	40.5	43.0	1.5	58.0	58.0	1.5	4.0	3.0	0.40
	68.262	22.225	22.225	17.462	3.5	1.5	59.1	70.2	6000	8000	02475	02420	5.1	0.42	1.44	0.79	38.5	44.5	3.5	63.0	59.0	1.5	5.5	3.0	0.37
	68.262	22.225	22.225	17.462	0.8	1.5	59.1	70.2	6000	8000	02476	02420	5.1	0.42	1.44	0.79	38.5	44.5	0.8	63.0	59.0	1.5	5.5	3.0	0.38
	73.025	22.225	22.225	17.462	3.5	3.3	60.8	74.9	5600	7400	02875	02820	3.8	0.45	1.32	0.73	39.5	45.5	3.5	68.0	62.0	3.3	5.0	3.0	0.44
	73.025	22.225	22.225	17.462	0.8	3.3	60.8	74.9	5600	7400	02876	02820	3.8	0.45	1.32	0.73	39.5	40.0	0.8	68.0	62.0	3.3	5.0	3.0	0.45
	73.025	29.37	27.783	23.02	1.3	3.3	80.6	111	5600	7500	HM88542	HM88510	5.6	0.55	1.10	0.60	42.5	45.5	1.3	70.0	59.0	3.3	6.5	2.0	0.61
	73.812	29.37	27.783	23.02	1.3	0.8	80.6	111	5600	7500	HM88542	HM88511	5.6	0.55	1.10	0.60	42.5	45.5	1.3	70.0	62.0	0.8	6.5	2.0	0.62
79.375	25.4	24.074	17.462	1.5	1.5	71.9	76.2	5500	7300	43125	43312	2.0	0.67	0.90	0.49	41.5	44.0	1.5	74.0	67.0	1.5	7.0	3.5	0.57	
33.338	68.262	22.225	22.225	17.462	0.8	1.5	59.6	77.4	6020	7900	M88048	M88010	2.8	0.55	1.10	0.60	41.0	42.5	0.8	65.0	58.0	1.5	4.0	3.0	0.37
	72	19	18.923	15.875	3.5	1.5	54.4	60.1	5900	7800	26131	26283	4.2	0.36	1.67	0.92	38.5	44.5	3.5	65.0	62.0	1.5	4.5	3.0	0.34
	73.025	29.37	27.783	23.02	0.8	3.3	80.6	111	5600	7500	HM89443	HM88510	5.6	0.55	1.10	0.60	42.6	45.5	0.8	70.0	59.0	3.3	6.5	2.0	0.59
	76.2	29.37	28.575	23.02	0.8	3.3	86.2	119	5400	7200	HM89443	HM89410	5.6	0.55	1.10	0.60	44.5	46.5	0.8	73.0	62.0	3.3	5.5	3.0	0.66
	79.375	25.4	24.074	17.462	3.5	1.5	71.9	76.2	5500	7300	43131	43312	2.0	0.67	0.90	0.49	42.0	51.0	3.5	74.0	67.0	1.5	7.0	3.5	0.55
	79.375	25.4	24.074	17.462	2	1.5	71.9	76.2	5500	7300	43132	43312	2.0	0.67	0.90	0.49	42.0	48.0	2.0	74.0	67.0	1.5	7.0	3.5	0.56
	88.501	25.4	23.698	17.462	2	1.5	77.9	88.6	3900	5500	43131	43318	2.3	0.78	0.77	0.42	48.0	51.0	2.0	84.0	75.0	1.5	5.5	4.0	0.76
34.925	65.088	18.034	18.288	13.97	**2)	1.3	50.5	63.1	6000	8000	LM48548	LM48510	3.6	0.38	1.59	0.88	40.0	46.0	**2)	61.0	58.0	1.3	4.5	3.0	0.26
	69.012	19.845	19.583	15.875	1.5	1.3	50.6	61.7	5900	7800	14137A	14276	4.3	0.38	1.57	0.86	40.0	42.0	1.5	63.0	60.0	1.3	4.5	3.0	0.32
	72.233	25.4	25.4	19.842	2.3		71.1	94.2	5700	7600	HM88649	HM88610	4.6	0.55	1.10	0.6	42.5	48.5	2.3	69.0	60.0	2.3	5.5	4.0	0.50
	72.238	20.638	20.638	15.875	3.5	1.3	52.4	65.8	5600	7400	16137	16284	4.1	0.40	1.49	0.82	40.5	47.0	3.5	67.0	63.0	1.3	5.5	3.0	0.38
	73.025	22.225	22.225	17.462	3.5	3.3	60.8	74.9	5500	7400	02877	02820	3.8	0.45	1.32	0.73	42.0	48.5	3.5	68.0	62.0	3.3	5.0	3.0	0.41
	73.025	22.225	22.225	17.462	0.8	3.3	60.8	74.9	5500	7400	02878	02820	3.8	0.45	1.32	0.73	42.0	42.5	0.8	68.0	62.0	3.3	5.0	3.0	0.42
	73.025	23.812	24.608	19.05	1.5	0.8	78.8	97.4	5600	7400	25877	25821	8.1	0.29	2.07	1.14	40.5	43.0	1.5	68.0	65.0	0.8	5.5	4.5	0.46
	76.2	23.812	25.654	19.5	5	3.3	80.4	102	5300	7000	2786	2720	8.1	0.30	1.98	0.82	41.0	51.0	5.0	70.0	66.0	3.3	5.0	5.0	0.52
	76.2	29.37	28.575	23.812	3.5	3.3	87.7	107	5400	7200	31594	31520	7.6	0.40	1.49	1.09	43.5	46.0	1.5	72.0	64.0	3.3	6.0	2.5	0.61
	79.375	29.37	29.711	23.812	3.5	3.3	96.9	119	5400	7200	3478	3420	8.6	0.37	1.64	0.82	43.5	50.0	3.5	74.0	67.0	3.3	6.0	3.5	0.70
	80.035	21.433	20.94	15.875	1.5	1.5	58.8	68.9	5200	6900	28137	28317	4.8	0.40	1.49	0.90	41.0	43.5	1.5	73.0	69.0	1.5	4.5	3.0	0.50
95.25	27.782	29.9	22.225	0.8	2.3	118	144	4500	5900	449	432	9.1	0.28	2.11	1.16	43.5	44.0	0.8	87.0	83.0	2.3	6.0	5.0	1.07	
34.980	59.131	15.875	16.764	11.938	**2)	1.3	35.5	49.3	6400	8500	L68149	L68110	2.5	0.42	1.44	0.79	39.0	45.5	**2)	56.0	53.0	1.3	4.0	3.0	0.18
	59.975	15.875	16.764	11.938	**	1.3	35.5	49.3	6400	8500	L68149	L68111	2.5	0.42	1.44	0.79	39.0	45.5	**	56.0	53.0	1.3	4.0	3.0	0.18

Remarks: 1.) When a is negative, it represents that the useful load center on the outer side of the bearing
2.)** represents that the inner race adopts compound fillet.

06 | Tapered Roller Bearing

Single row taper roller bearing

Inch Series

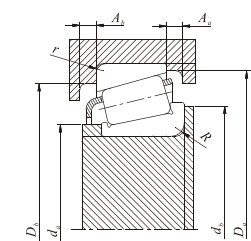
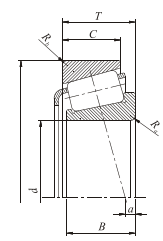

d 35.000~39.688mm

d	Main Dimension (mm)					Basic Load Rating (kN)		Limit Speed (r/min)		Bearing No.		Load center mm a ¹⁾	Constant e	Axial load coefficient		Mounting dimensions (mm)						Weight (kg)			
	D	T	B	C	(R _s) min	(R _b) min	C _r	C _{or}	Grease Lubrication	Oil Lubrication	Cone			Cup	Y ₁	Y ₀	Shaft d _a d _b RMax	Bearing housing D _a D _b rMax	Retainer A _a A _b						
35.000	79.375	23.812	25.400	19.050	0.8	0.8	84.3	110	5000	6700	26883	26822	7.4	0.32	1.88	1.04	42.0	42.5	0.8	74.0	71.0	0.8	5.0	4.5	0.60
	80.000	21.000	22.403	17.826	0.8	1.3	73.6	83.4	4900	6000	339	332	6.2	0.27	2.20	1.21	41.5	42.5	0.8	75.0	73.0	1.3	5.0	4.5	0.53
35.717	72.233	25.400	25.400	19.842	3.5	2.3	71.1	94.2	5700	7600	HM88648	HM88610	4.6	0.55	1.10	0.60	43.0	52.0	3.5	69.0	60.0	2.3	5.5	4.0	0.48
36.487	73.025	23.812	24.608	19.050	1.5	0.8	78.8	97.4	5600	7400	25880	25821	8.1	0.29	2.07	1.14	42.0	44.0	1.5	68.0	65.0	0.8	5.5	4.5	0.45
	76.200	23.812	25.654	19.050	1.5	3.3	80.4	102	5400	7200	2780	2720	8.1	0.3	1.98	1.09	42.5	44.5	1.5	70.0	66.0	3.3	5.0	5.0	0.52
36.512	79.200	29.370	28.575	23.020	3.5	0.8	86.2	119	5400	7200	HM89449	HM89441	5.6	0.55	1.10	0.60	44.5	54.0	3.5	73.0	65.0	0.8	5.5	3.0	0.62
	79.375	23.812	25.400	19.050	0.8	0.8	84.3	110	5000	6700	26877	26822	7.4	0.32	1.88	1.04	43.0	44.0	0.8	74.0	71.0	0.8	5.0	4.5	0.59
	79.375	29.370	29.771	23.812	0.8	3.3	96.9	119	5200	6900	3479	3420	8.6	0.37	1.64	0.90	44.5	45.5	0.8	74.0	67.0	3.3	6.0	3.5	0.68
	85.725	30.162	30.162	23.812	0.8	3.3	115	148	4800	6400	3878	3820	8.1	0.40	1.49	0.82	47.0	48.0	0.8	81.0	73.0	3.3	7.0	4.5	0.89
	88.500	25.400	23.698	17.462	2.3	1.5	77.9	88.6	3900	5500	44143	44348	-2.3	0.78	0.77	0.42	50.0	54.0	2.3	84.0	75.0	1.5	5.5	4.0	0.72
38.000	63.000	17.000	17.000	13.500	** 2)	1.3	39.8	55.0	6000	8000	JL69349	JL69310	2.3	0.42	1.44	0.79	42.5	49.0	**2)	60.0	56.0	1.3	4.0	3.0	0.19
38.100	63.500	12.700	11.908	9.525	1.5	0.8	25.1	33.0	5800	7700	13889	13830	0.8	0.35	1.73	0.95	42.5	45.0	1.5	60.0	59.0	0.8	4.0	2.0	0.14
	65.088	12.700	11.908	9.525	1.5	0.8	25.1	33.0	5800	7700	13889	13836	0.8	0.35	1.73	0.95	42.5	45.0	1.5	61.0	59.0	0.8	4.0	2.0	0.15
	65.088	18.034	18.288	13.970	**	1.3	45.0	60.3	5800	7800	LM29748	LM29710	4.1	0.33	1.80	0.99	42.5	49.0	**	62.0	59.0	1.3	4.5	3.0	0.22
	65.088	19.812	18.288	15.748	2.3	1.3	45.0	60.3	5800	7800	LM29749	LM29711	4.1	0.33	1.80	0.99	42.5	46.0	2.3	62.0	58.0	1.3	4.5	1.5	0.24
	69.012	19.050	19.050	15.083	2.0	2.3	52.5	67.9	5600	7500	13687	13621	3.0	0.40	1.49	0.82	43.0	46.5	2.0	65.0	61.0	2.3	4.0	2.5	0.29
	71.438	15.875	16.520	11.908	1.5	1.0	46.9	57.8	5700	7600	19150	19281	1.5	0.44	1.35	0.74	43.0	45.0	1.5	66.0	63.0	1.0	4.0	4.0	0.27
	76.200	23.812	25.654	19.050	3.5	3.3	80.4	102	5400	7200	2788	2720	8.1	0.30	1.98	1.09	43.5	50.0	3.5	77.0	66.0	3.3	5.0	5.0	0.49
	79.375	29.370	29.771	23.812	3.5	3.3	96.9	119	5200	6900	3490	3420	8.6	0.37	1.64	0.90	45.5	52.0	3.5	74.0	67.0	3.3	6.0	3.5	0.65
	80.035	21.006	20.940	15.875	1.5	1.5	58.8	68.9	5300	7000	28150	28315	4.8	0.40	1.49	0.82	43.5	45.5	1.5	73.0	69.0	1.5	4.5	3.5	0.46
	80.035	24.608	23.698	18.512	0.8	1.5	72.2	91.1	5200	6900	27880	27820	2.5	0.56	1.07	0.59	47.0	48.0	0.8	75.0	68.0	1.5	4.5	2.5	0.56
	80.035	24.608	23.698	18.512	3.5	1.5	72.2	91.1	5200	6900	27881	27820	2.5	0.56	1.07	0.59	47.0	48.0	3.5	75.0	68.0	1.5	4.5	2.5	0.55
	82.550	29.370	28.575	23.020	0.8	3.3	95.1	130	4900	6600	HM801346	HM801310	4.8	0.55	1.10	0.60	49.1	51.0	0.8	78.0	68.0	3.3	6.0	3.0	0.76
	82.550	29.370	28.575	23.020	2.3	3.3	95.1	130	4900	6600	HM801346X	HM801310	4.8	0.55	1.10	0.60	49.1	54.0	2.3	78.0	68.0	3.3	6.0	3.0	0.53
	82.931	23.812	25.400	19.050	0.8	0.8	83.8	111	4800	6300	25572	25520	6.4	0.33	1.79	0.99	46.0	46.0	0.8	77.0	74.0	0.8	5.5	4.5	0.64
	88.500	25.400	23.698	17.462	2.3	1.5	77.9	88.6	3900	5500	44150	44348	-2.3	0.78	0.77	0.42	51.0	55.0	2.3	84.0	75.0	1.5	5.5	4.0	0.71
88.500	26.988	29.083	22.225	3.5	1.5	107	124	4900	6500	418	414	9.7	0.26	2.28	1.25	44.5	51.0	3.5	80.0	77.0	1.5	6.0	5.0	0.82	
90.488	39.688	40.386	38.338	1.5	3.3	155	204	4500	6000	4375	4335	15	0.28	2.11	1.16	48.5	51.0	1.5	85.0	77.0	3.3	6.5	3.5	1.30	
95.250	30.958	28.300	20.638	1.5	0.8	92.8	104	3700	5200	53150	53375	0.3	0.74	0.81	0.45	53.0	55.0	1.5	89.0	81.0	0.8	7.0	2.0	1.04	
101.60	34.925	36.068	26.988	3.5	3.3	152	192	4000	5300	525	522	12.7	0.29	2.15	1.16	48.0	54.0	3.5	95.0	89.0	3.3	8.0	5.5	1.47	
39.688	73.025	16.667	17.462	12.700	0.8	1.5	47.0	58.1	5200	6900	18587	18250	2.8	0.35	1.71	0.94	45.0	45.5	0.8	69.0	66.0	1.5	5.5	4.0	0.29
	76.200	23.812	25.654	19.050	3.5	3.3	80.4	102	5400	7200	2789	2720	8.1	0.30	1.98	1.09	45.0	52.0	3.5	70.0	66.0	3.3	5.0	5.0	0.47
	80.167	29.370	30.391	23.812	0.8	3.3	106	129	5000	6700	3886	3320	10.9	0.27	2.20	1.21	45.5	46.5	0.8	75.0	70.0	3.3	6.0	4.5	0.65
	84.138	29.370	30.391	23.812	0.8	3.3	106	129	5000	6700	3382	3328	10.9	0.27	2.20	1.21	45.0	52.0	0.8	76.0	72.0	3.3	6.0	4.5	0.75
	88.500	25.400	23.698	17.462	3.5	1.5	77.9	88.6	3900	5500	44158	44348	-2.3	0.78	0.77	0.42	51.0	58.0	3.5	84.0	75.0	1.5	5.5	4.0	0.68

Remarks: 1.) When a is negative, it represents that the useful load center on the outer side of the bearing
2.)** represents that the inner race adopts compound fillet.

06 | Tapered Roller Bearing

Single row taper roller bearing

Inch Series

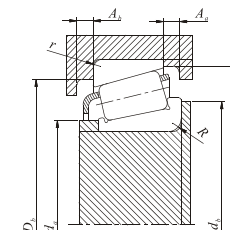
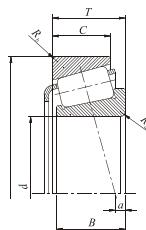

d 40.000~42.875mm

d	Main Dimension (mm)					Basic Load Rating (kN)		Limit Speed (r/min)		Bearing No.		Load center mm a ¹⁾	Constant e	Axial load coefficient		Mounting dimensions (mm)						Weight (kg)			
	D	T	B	C	(Ra) min	(Rb) min	Cr	Cor	Grease Lubrication	Oil Lubrication	Cone			Cup	Y ₁	Y ₀	Shaft			Bearing housing			Retainer		
40.000	76.200	20.638	20.940	15.507	1.5	1.3	58.8	68.9	5300	7000	28158	28300	4.8	0.40	1.49	0.82	45.0	47.5	1.5	71.0	68.0	1.3	4.5	4.0	0.38
	80.000	21.000	22.403	17.826	3.5	1.3	73.6	83.4	4900	6600	344	332	6.4	0.27	2.20	1.21	45.5	52.0	3.5	75.0	73.0	1.3	5.0	4.5	0.47
	80.000	21.000	22.403	17.826	0.8	1.3	73.6	83.4	4900	6600	344A	332	6.2	0.27	2.20	1.21	45.5	46.0	0.8	75.0	73.0	1.3	5.0	4.5	0.47
	85.000	20.638	21.692	17.462	0.8	1.3	75.8	89.2	4600	6200	350A	354A	4.8	0.31	1.96	1.08	46.5	47.5	0.8	80.0	77.0	1.3	5.0	5.0	0.55
	88.500	26.988	29.083	22.225	3.5	1.5	108	124	4900	6500	420	414	9.7	0.26	2.28	1.25	46.0	52.0	3.5	80.0	77.0	1.5	6.0	5.0	0.79
	107.95	36.512	36.957	28.575	3.3	3.3	159	206	3800	5100	543	532A	12.2	0.30	2.02	1.11	50.0	57.0	3.5	100	94.0	3.3	8.0	4.0	1.74
40.483	82.550	29.370	28.575	23.020	3.5	3.3	95.1	130	4900	6600	HM801349	HM801310	4.8	0.55	1.10	0.6	49.0	58.0	3.5	78.0	68.0	3.3	6.0	3.0	0.73
41.275	73.025	16.667	17.460	12.700	3.5	105	47.0	58.1	5200	6900	18590	18520	2.8	0.35	1.71	0.94	46.0	53.0	3.5	69.0	66.0	1.5	5.5	4.0	0.27
	73.431	19.558	19.812	14.732	3.5	0.8	58.4	74.2	5200	7000	LM501349	LM501310	3.3	0.40	1.50	0.83	46.5	53.0	3.5	70.0	67.0	0.8	5.5	3.5	0.32
	73.431	21.430	19.812	16.604	3.5	0.8	58.4	74.2	5200	7000	LM501349	LM501314	3.3	0.40	1.50	0.83	46.5	53.0	3.5	70.0	66.0	0.8	5.5	1.5	0.34
	76.200	18.009	17.384	14.288	1.5	1.5	44.5	55.1	5200	6900	11162	11300	0.8	0.49	1.23	0.68	46.5	49.0	1.5	71.0	67.0	1.5	3.5	3.0	0.33
	76.200	22.225	23.020	17.462	3.5	0.8	69.9	89.2	5200	6900	24780	24720	4.8	0.39	1.53	0.84	47.0	54.0	3.5	72.0	68.0	0.8	5.5	3.5	0.41
	80.000	21.000	22.403	17.826	0.8	1.3	73.6	83.4	4900	6600	336	332	6.2	0.27	2.20	1.21	46.0	47.0	0.8	75.0	73.0	1.3	5.0	4.5	0.46
	80.000	21.000	22.403	17.826	3.5	1.3	73.6	83.4	4900	6600	342	332	6.2	0.27	2.20	1.21	46.0	53.0	3.5	75.0	73.0	1.3	5.0	4.5	0.45
	82.550	26.543	25.654	20.193	3.5	3.3	84.9	112	4900	6500	M802048	M802011	3.0	0.55	1.10	0.60	51.0	57.0	3.5	79.0	70.0	3.3	5.5	3.0	0.62
	82.725	30.162	30.162	23.812	3.5	1.3	115	148	4800	6400	3877	3821	8.1	0.40	1.49	0.82	50.0	57.0	3.5	81.0	75.0	1.3	7.0	4.5	0.83
	87.312	30.162	30.886	23.812	0.8	3.3	105	134	4800	6400	3576	3525	10.2	0.31	1.96	1.08	48.0	49.0	0.8	81.0	75.0	3.3	6.5	3.5	0.82
	88.501	26.988	29.083	22.225	3.5	1.5	107	124	4600	6200	419	414	9.7	0.26	2.28	1.25	47.0	54.0	3.5	80.0	77.0	1.5	6.0	5.0	0.77
	88.900	20.638	22.225	16.513	3.5	1.3	79.5	95.8	4900	6500	365A	362A	4.3	0.32	1.88	1.03	48.5	55.0	3.5	84.0	81.0	1.3	5.5	5.0	0.62
	88.900	30.162	29.370	23.020	3.5	3.3	105	144	4400	5800	HM803146	HM803110	4.3	0.55	1.10	0.60	53.0	60.0	3.5	85.0	74.0	3.3	7.5	4.0	0.89
	88.900	30.162	29.370	23.020	3.5	0.8	105	144	4600	6100	HM803146	HM803111	4.3	0.55	1.10	0.60	53.0	60.0	3.5	85.0	76.0	0.8	7.5	4.0	0.90
	90.488	39.688	40.386	33.338	3.5	3.3	155	204	4500	6000	4388	4335	15.0	0.28	2.11	1.16	51.0	57.0	3.5	85.0	77.0	3.3	6.5	3.5	1.23
93.662	31.750	31.750	26.195	0.8	3.3	120	158	4400	5800	46162	46368	7.9	0.40	1.49	0.82	51.0	52.0	0.8	87.0	79.0	3.3	5.5	3.5	1.07	
95.250	30.162	29.370	23.020	3.5	3.3	115	157	3300	4400	HM804840	HM804810	3.8	0.55	1.10	0.60	54.0	61.0	3.5	91.0	81.0	3.3	7.0	4.5	1.06	
104.775	36.513	36.512	28.575	1.5	3.3	159	223	3800	5100	HM807035	HM807010	7.4	0.49	1.23	0.68	57.0	60.0	1.5	100	89.0	3.3	7.0	4.0	1.69	
42.070	90.488	39.688	40.386	33.338	3.5	3.3	155	204	4500	6000	4395	4335	15.0	0.28	2.11	1.16	51.0	58.0	3.5	85.0	77.0	3.3	6.5	3.5	1.21
42.862	76.992	17.462	17.145	11.908	1.5	1.5	45.9	58.1	5000	6600	12168	12303	0	0.51	1.19	0.65	48.5	51.0	1.5	73.0	68.0	1.5	6.0	3.5	0.31
42.875	79.375	23.812	25.400	19.050	3.5	0.8	84.3	110	5000	67000	26884	26822	7.4	0.32	1.88	1.04	48.5	55.0	3.5	74.0	71.0	0.8	5.0	4.5	0.50
	82.931	23.812	25.400	19.050	3.5	0.8	83.8	111	4800	6300	25577	25520	6.4	0.33	1.79	0.99	49.0	55.0	3.5	77.0	74.0	0.8	5.5	4.5	0.58

Remarks: 1.) When a is negative, it represents that the useful load center on the outer side of the bearing
2.)** represents that the inner race adopts compound fillet.

06 | Tapered Roller Bearing

Single row taper roller bearing

Inch Series

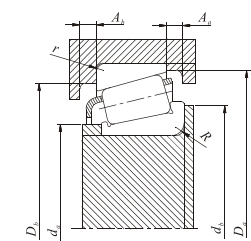
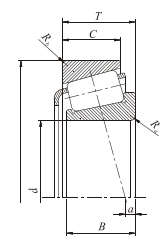

d 44.450~46.038mm

d	Main Dimension (mm)					Basic Load Rating (kN)		Limit Speed (r/min)		Bearing No.		Load center mm a ¹⁾	Constant e	Axial load coefficient		Mounting dimensions (mm)						Weight (kg)			
	D	T	B	C	(R _s) min	(R _b) min	C _r	C _{or}	Grease Lubrication	Oil Lubrication	Cone			Cup	Y ₁	Y ₀	Shaft			Bearing housing			Retainer		
																	d _a	d _b	RMax	D _a	D _b		rMax	A _a	A _b
44.450	73.025	18.258	18.258	15.083	1.5	1.5	52.8	73.8	5100	6800	L102849	L102810	3.8	0.32	1.88	1.04	49.0	51.0	1.5	69.0	66.0	1.5	4.5	3.0	0.30
	79.992	17.462	17.145	11.908	1.5	1.5	45.9	58.1	5000	6600	12175	12303	0	0.51	1.19	0.65	49.5	52.0	1.5	73.0	68.0	1.5	6.0	3.5	0.30
	79.375	17.462	17.462	13.495	2.8	1.5	48.2	61.3	4800	6400	18685	18620	2	0.37	1.60	0.88	49.5	54.0	2.8	74.0	71.0	1.5	5.0	3.5	0.34
	82.931	23.812	25.400	19.050	5.0	0.8	83.8	111	4800	6300	25582	25520	6.4	0.33	1.79	0.99	50.0	60.0	5.0	77.0	74.0	0.8	5.5	4.5	0.55
	84.138	30.162	30.886	23.812	3.5	3.3	105	134	4600	6200	3578	3520	10.2	0.31	1.96	1.08	51.0	57.0	3.5	80.0	74.0	3.3	6.5	3.5	0.68
	85.000	20.638	21.692	17.462	2.3	1.3	75.8	89.2	4600	6200	355	354A	4.8	0.31	1.96	1.08	50.0	54.0	2.3	80.0	77.0	1.3	5.0	5.0	0.50
	85.000	20.638	21.692	17.462	0.8	1.3	75.8	89.2	4600	6200	355A	355A	4.8	0.31	1.96	1.08	50.0	51.0	0.8	80.0	77.0	1.3	5.0	5.0	0.50
	88.900	30.162	29.370	23.020	3.5	3.3	105	144	4600	6100	HM803149	HM803110	4.3	0.55	1.10	0.60	53.4	62.0	3.5	85.0	74.0	3.3	7.5	4.0	0.84
	93.662	31.750	31.750	26.195	0.8	3.3	120	158	4400	5900	46175	46368	7.8	0.40	1.49	0.92	54.0	55.0	0.8	87.0	79.0	3.3	5.5	3.5	1.01
	93.662	31.750	31.750	25.400	3.5	3.3	126	156	4400	5800	49175	49368	9.1	0.36	1.67	0.82	53.0	59.0	3.5	87.0	82.0	3.3	5.5	3.0	1.00
	93.662	31.750	31.750	26.195	3.5	3.3	120	158	4400	5800	46176	46368	7.8	0.40	1.49	0.82	54.0	60.0	3.5	87.0	79.0	3.3	5.5	3.5	1.01
	95.250	27.783	28.575	22.225	0.8	2.3	120	161	4100	5400	33885	33821	7.6	0.33	1.82	1.00	53.0	53.0	0.8	90.0	85.0	2.3	6.5	5.5	0.96
	95.250	27.783	29.000	22.225	3.5	0.8	118	144	4500	5900	438	432A	9.1	0.28	2.11	1.16	51.0	57.0	3.5	87.0	84.0	0.8	6.0	5.0	0.93
	95.250	30.162	29.370	23.020	0.8	3.3	115	157	3300	4400	HM804842	HM804810	3.8	0.55	1.10	0.6	57.0	57.0	0.8	91.0	81.0	3.3	7.0	4.5	1.02
	95.250	30.162	29.370	23.020	3.5	3.3	115	157	3700	5200	HM804843	HM804810	3.8	0.55	1.10	0.6	57.0	63.0	3.5	91.0	81.0	3.3	7.0	4.5	1.01
	95.250	30.958	28.300	20.638	3.5	0.8	92.8	104	3700	5200	53177	53375	0.3	0.74	0.81	0.45	53.0	63.0	3.5	89.0	81.0	0.8	7.0	2.0	0.94
	95.250	30.958	28.300	20.638	2.0	0.8	92.8	104	3700	5200	53178	53375	0.3	0.74	0.81	0.45	53.0	60.0	2.0	89.0	81.0	0.8	7.0	2.0	0.94
	95.250	30.958	28.575	22.225	3.5	0.8	107	132	3700	5100	HM903249	HM903210	-0.5	0.74	0.81	0.45	54.0	65.0	3.5	91.0	81.0	0.8	7.0	2.0	1.00
	98.425	31.750	31.750	25.400	0.8	3.3	123	155	3900	5200	49576	49520	7.1	0.40	1.50	0.82	54.0	55.0	0.8	96.0	88.0	3.3	6.5	4.0	1.23
	98.425	30.958	28.300	20.638	1.3	0.8	92.8	104	3700	5200	53176	53387	0.3	0.74	0.81	0.45	53.0	59.0	1.3	91.0	82.0	0.8	7.0	2.0	1.03
101.6	34.926	30.068	26.988	3.5	3.3	152	192	4000	5300	527	522	12.7	0.29	2.10	1.16	53.0	59.0	3.5	95.0	89.0	3.3	8.0	5.5	1.35	
104.775	36.512	36.512	28.575	3.5	3.3	159	223	3800	5100	HM807040	HM807010	7.4	0.49	1.23	0.68	59.0	66.0	3.5	100	89.0	3.3	7.0	4.0	1.62	
111.125	30.162	26.909	20.638	3.5	3.3	118	161	3100	4300	55175C	55437	-7.6	0.88	0.68	0.37	64.0	70.0	3.5	105	92.0	3.3	6.0	3.5	1.44	
111.125	30.162	26.909	20.638	0.8	3.3	118	161	3100	4300	55176C	55437	-7.6	0.88	0.68	0.37	64.0	65.0	0.8	105	92.0	3.3	6.0	3.5	1.44	
111.125	38.100	36.957	30.162	3.5	3.3	159	206	3800	5100	535	532A	12.2	0.3	2.02	1.11	54.0	60.0	3.5	100	95.0	3.3	8.0	2.5	1.84	
44.983	93.264	30.162	30.302	23.812	3.5	3.3	113	153	4200	5500	3776	3720	8.1	0.34	1.77	0.97	53.0	59.0	3.5	88.0	82.0	3.3	7.0	3.5	0.94
44.988	95.250	30.958	28.575	22.225	3.5	0.8	107	132	3700	5100	HM903248	HM903210	-0.5	0.74	0.81	0.45	54.0	66.0	3.5	91.0	81.0	0.8	7.0	2.0	0.99
45.000	85.000	20.638	21.692	17.462	1.5	1.3	75.8	89.2	4600	6200	358	354A	4.8	0.31	1.96	1.08	50.0	53.0	1.5	80.0	77.0	1.3	5.0	5.0	0.50
45.242	73.431	19.558	19.812	15.748	3.5	0.8	56.9	81.8	5100	6700	LM102949	LM102910	4.6	0.31	1.97	1.08	50.0	56.0	3.5	70.0	68.0	0.8	4.5	3.0	0.31
	77.788	19.842	19.842	15.080	3.5	0.8	59.6	77.9	4900	6500	LM102949	LM103011	2.3	0.43	1.41	0.77	50.0	57.0	3.5	74.0	71.0	0.8	5.0	3.5	0.36
	77.788	21.430	19.842	16.667	3.5	0.8	59.6	77.9	4900	6500	LM102949	LM103012	2.3	0.43	1.41	1.08	50.0	57.0	3.5	74.0	70.0	0.8	5.0	2.0	0.37
	80.000	19.842	19.842	15.080	3.5	0.8	59.6	77.9	4900	6500	LM102949	LM103014	2.3	0.43	1.41	0.77	51.0	58.0	3.5	75.0	71.0	0.8	5.0	3.5	0.39
45.518	85.000	23.812	25.400	19.050	3.5	2.3	83.8	111	4800	6300	25590	25526	6.4	0.33	1.79	0.99	51.0	58.0	3.5	78.0	74.0	2.3	5.5	4.5	0.57
45.987	74.976	18.000	18.000	14.000	2.3	1.5	52.6	75.4	5000	6600	LM503349	LM503310	2.0	0.40	1.49	0.82	51.0	55.0	2.3	71.0	67.0	1.5	5.0	3.5	0.30
46.038	79.375	17.462	17.462	13.495	2.8	1.5	48.2	61.3	4800	6400	18690	18620	2.0	0.37	1.60	0.88	51.0	56.0	2.8	74.0	71.0	1.5	5.0	3.5	0.33
	85.000	20.638	21.692	17.462	3.5	1.3	75.8	89.2	4800	6200	359A	354A	4.8	0.31	1.96	1.08	51.0	57.0	3.5	80.0	77.0	1.3	5.0	5.0	0.48
	85.000	20.638	21.692	17.462	2.3	1.3	75.8	89.2	4800	6200	359S	354A	4.8	0.31	1.96	1.08	51.0	55.0	2.3	80.0	77.0	1.3	5.0	5.0	0.48
	85.000	25.400	25.608	20.638	3.5	1.3	86.4	117	4800	6100	2984	2924	6.4	0.35	1.73	0.95	52.0	58.0	3.5	80.0	76.0	1.3	5.0	5.0	0.60

Remarks: 1.) When a is negative, it represents that the useful load center on the outer side of the bearing
2.)** represents that the inner race adopts compound fillet.

06 | Tapered Roller Bearing

Single row taper roller bearing

Inch Series

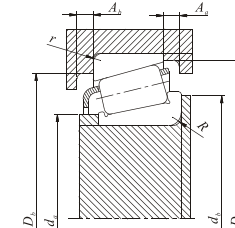
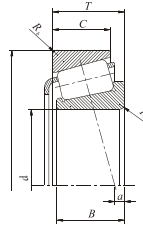

d 47.625~50.800mm

	Main Dimension (mm)						Basic Load Rating (kN)		Limit Speed (r/min)		Bearing No.		Load center mm a ¹⁾	Constant e	Axial load coefficient		Mounting dimensions (mm)						Weight (kg)		
	d	D	T	B	C	(R _a) min	(R _b)	C _r	C _{or}	Grease Lubrication	Oil Lubrication	Cone			Cup	Y ₁	Y ₀	Shaft			Bearing housing			Retainer	
47.625	88.900	20.638	22.225	16.513	3.5	1.3	79.5	95.8	4400	5800	369A	362A	4.3	0.32	1.88	1.03	d _a	d _b	RMax	D _a	D _b	rMax	A _a	A _b	0.54
	88.900	25.400	25.400	19.050	3.5	3.3	91.3	116	4400	5900	M804049	M804010	1.8	0.55	1.10	0.6	56.0	63.0	3.5	85.0	77.0	3.3	6.5	4.5	0.65
	95.250	30.162	29.370	23.020	3.5	3.3	115	157	3300	4400	HM804046	HM804810	3.8	0.55	1.10	0.6	57.0	66.0	3.5	91.0	81.0	3.3	7.0	4.5	0.96
	96.838	21.000	21.946	15.875	0.8	0.8	84.2	108	3900	5200	386A	382A	3.0	0.35	1.69	0.93	55.0	56.0	0.8	92.0	89.0	0.8	6.0	5.5	0.72
	101.600	34.925	36.068	26.988	3.5	3.3	152	192	4000	5300	528	522	12.7	0.29	2.10	1.16	55.0	62.0	3.5	95.0	89.0	3.3	8.0	5.5	1.29
	104.775	30.162	29.317	24.605	4.8	3.3	126	166	3700	4900	463	453X	7.1	0.34	1.79	0.98	56.0	65.0	4.8	98.0	92.0	3.3	5.5	3.0	1.21
	104.775	30.162	29.317	24.605	0.8	3.3	126	166	3700	4900	467	453X	7.1	0.34	1.79	0.98	56.0	57.0	0.8	98.0	92.0	3.3	5.5	3.0	1.22
	104.775	30.162	30.958	23.812	3.5	3.3	142	189	3700	4900	45282	45220	8.1	0.33	1.8	0.99	57.0	63.0	3.5	99.0	93.0	3.3	6.5	5.0	1.26
	111.125	30.162	26.909	20.638	3.5	3.3	118	161	3200	4400	55187C	55437	-7.6	0.88	0.68	0.37	62.0	69.0	3.5	105.0	92.0	3.3	6.0	3.5	1.39
	112.712	30.162	26.909	20.638	3.5	3.3	118	161	3100	4300	55187C	55443	-7.6	0.88	0.68	0.37	62.0	69.0	3.5	106.0	92.0	3.3	6.0	3.5	1.47
48.412	95.250	30.162	29.370	23.020	2.3	3.3	115	157	3300	4400	HM804848	HM804810	3.8	0.55	1.10	0.6	57.0	63.0	2.3	91.0	81.0	3.3	7.0	4.5	0.95
	95.250	30.162	29.370	23.020	3.5	3.3	115	157	3300	4400	HM804849	HM804810	3.8	0.55	1.10	0.6	57.0	63.0	3.5	91.0	83.0	3.3	7.0	4.5	0.95
49.212	88.900	20.638	22.225	16.513	0.8	1.3	79.5	95.8	4400	5800	365S	362A	4.3	0.32	1.88	1.03	54.0	55.0	0.8	84.0	81.0	1.3	5.5	5.0	0.53
	104.775	36.512	36.512	28.575	3.5	3.3	159	223	3800	5100	HM807044	HM807010	7.4	0.49	1.23	0.68	63.0	69.0	3.5	100.00	89.0	3.3	7.0	4.0	1.52
	114.3	44.500	44.500	34.925	3.5	3.3	207	256	3800	5000	65390	65320	12.4	0.43	1.39	0.77	60.0	70.0	3.5	107.0	97.0	3.3	9.0	4.0	2.18
	114.3	44.500	44.500	36.068	3.5	3.3	228	290	3700	5000	HH506348	HH506310	13.5	0.40	1.49	0.82	61.0	71.0	3.5	107.0	97.0	3.3	9.5	6.0	2.34
49.987	92.075	24.608	25.400	19.845	2.3	0.8	91.6	130	4200	5600	28579	28521	4.8	0.38	1.59	0.87	56.0	60.0	2.3	87.0	83.0	0.8	5.0	3.5	0.71
50.000	82.000	21.500	21.500	17.000	3.0	0.5	75.2	104	4500	6000	JLM104948	JLM104910	5.3	0.31	1.97	1.08	55.0	60.0	3.0	78.0	76.0	0.5	5.5	4.0	0.41
	88.900	20.638	22.225	16.513	2.0	1.3	79.5	95.8	4400	5800	365	362	4.3	0.32	1.88	1.03	55.0	58.0	2.0	84.0	81.0	1.3	5.5	5.0	0.51
	88.900	20.638	22.225	16.513	2.3	1.3	79.5	95.8	4400	5800	366	362A	4.3	0.32	1.88	1.03	55.0	59.0	2.3	84.0	81.0	1.3	5.5	5.0	0.51
	90.000	28.000	28.000	23.000	3.0	2.5	115	154	4300	5800	JM205149	JM205110	7.6	0.33	1.82	1.00	57.0	62.0	3.0	85.0	80.0	2.5	6.5	4.5	0.74
	105.000	37.000	36.000	29.000	3.0	2.5	159	223	3800	5100	JHM807045	JHM807012	7.4	0.49	1.23	0.68	63.0	69.0	3.0	100.0	90.0	2.5	6.5	4.0	1.52
	110.000	22.000	21.996	18.824	0.8	1.3	91.6	126	3400	4500	396	394A	0.8	0.40	1.49	0.82	60.0	61.0	0.8	104.0	101.0	1.3	4.0	4.5	1.04
50.800	80.962	18.258	18.258	14.288	1.5	1.5	56.3	88.8	4600	6100	L305649	L305610	2.5	0.36	1.69	0.93	56.0	58.0	1.5	77.0	73.0	1.5	5.0	3.5	0.34
	82.55	21.590	22.225	16.510	3.5	1.3	75.2	104	4500	6000	LM104949	LM104911	5.8	0.31	1.97	1.08	55.0	62.0	3.5	78.0	75.0	1.3	5.5	4.5	0.42
	85.725	19.050	18.263	12.700	1.5	1.5	47.8	63.9	4400	5900	18200	18337	-1.9	0.57	1.06	0.58	56.0	59.0	1.5	81.0	76.0	1.5	5.0	3.0	0.39
	88.900	17.462	17.462	13.495	3.5	1.3	50.6	67.5	4400	5900	18790	18724	0.8	0.41	1.48	0.81	56.0	62.0	3.5	82.0	78.0	1.3	5.0	3.5	0.42
	88.900	20.638	22.225	16.153	1.5	1.3	79.5	95.8	4400	5900	368	362A	4.3	0.32	1.88	1.03	56.0	58.0	1.5	84.0	81.0	1.3	5.5	5.0	0.50
	88.900	20.638	22.225	16.153	3.5	1.3	79.5	95.8	4400	5800	368A	362A	4.3	0.32	1.88	1.03	56.0	62.0	1.5	84.0	81.0	1.3	5.5	5.0	0.50
	88.900	20.638	22.225	16.513	5.0	1.3	79.5	95.8	4400	5800	370A	362A	4.3	0.32	1.88	1.03	56.0	65.0	5.0	84.0	81.0	1.3	5.5	5.0	0.49
	92.075	24.608	25.400	19.845	3.5	0.8	91.6	130	4200	5600	28580	28521	4.8	0.38	1.59	0.87	57.0	63.0	3.5	87.0	83.0	0.8	5.0	3.5	0.69
	93.264	20.638	22.225	15.083	2.3	1.3	81.4	101	4200	5600	375	374	3.8	0.34	1.77	0.97	57.0	60.0	2.3	88.0	85.0	1.3	7.0	5.5	0.59
	93.264	30.162	30.302	23.812	3.5	3.3	113	153	4200	5500	3780	3720	8.1	0.34	1.77	0.97	58.0	64.0	3.5	88.0	82.0	3.3	7.0	3.5	0.84
	93.264	30.162	30.302	23.812	3.5	0.8	113	153	4200	5500	3780	3730	8.1	0.34	1.77	0.97	58.0	64.0	3.5	88.0	84.1	0.8	7.0	3.5	0.85
	95.250	27.783	28.575	22.225	3.5	2.3	120	161	4100	5400	33889	33822	7.6	0.33	1.82	1.00	58.0	64.0	3.5	90.0	85.0	2.3	6.5	5.5	0.85
	96.838	21.000	21.946	15.875	2.3	0.8	84.2	108	3900	5200	385	382A	3.0	0.35	1.69	0.93	60.0	61.0	2.3	92.0	89.0	0.8	6.0	5.5	0.67
	97.630	24.608	24.608	19.446	3.5	0.8	96.3	142	3900	5200	28678	28622	3.3	0.40	1.49	0.82	58.0	65.0	3.5	92.0	88.0	0.8	5.0	4.0	0.83
	98.425	30.162	30.302	23.812	3.5	3.3	113	153	4200	5500	3870	3732	8.1	0.34	1.77	0.97	58.0	64.0	3.5	90.0	84.0	3.3	7.0	3.5	0.98

Remarks: 1.) When a is negative, it represents that the useful load center on the outer side of the bearing
2.)** represents that the inner race adopts compound fillet.

06 | Tapered Roller Bearing

Single row taper roller bearing

Inch Series

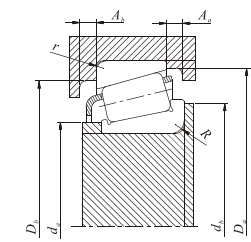
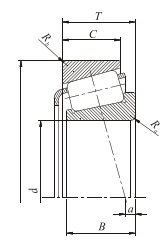

d 50.800~55.575mm

d	Main Dimension (mm)					Basic Load Rating (kN)		Limit Speed (r/min)		Bearing No.		Load center mm a ¹⁾	Constant e	Axial load coefficient		Mounting dimensions (mm)						Weight (kg)			
	D	T	B	C	(R _a) min	(R _b) min	C _r	C _{0r}	Grease Lubrication	Oil Lubrication	Cone			Cup	Y ₁	Y ₀	Shaft			Bearing housing			Retainer		
																	d _a	d _b	RMax	D _a	D _b		rMax	A _a	A _b
50.800	101.600	31.750	31.750	25.400	3.5	3.3	123	155	3900	5200	49585	49520	7.1	0.40	1.50	0.82	59.0	66.0	3.5	96.0	88.0	3.3	6.5	4.0	1.11
	101.600	34.925	36.068	26.998	0.8	3.3	152	192	4000	5300	529	522	12.7	0.29	2.10	1.16	58.0	59.0	0.8	95.0	89.0	3.3	8.0	5.5	1.23
	101.600	34.925	36.068	26.998	3.5	3.3	152	192	4000	5300	529X	522	12.7	0.29	2.10	1.16	58.0	65.0	3.5	95.0	89.0	3.3	8.0	5.5	1.22
	104.775	30.162	30.958	23.812	6.4	3.3	142	189	3700	4900	45284	25220	8.1	0.33	1.80	0.99	59.0	71.0	6.4	99.0	93.0	3.3	6.5	5.0	1.19
	104.775	36.512	36.512	28.575	3.5	3.3	159	223	3900	5100	HM807046	HM807010	7.4	0.49	1.23	0.68	63.0	70.0	3.5	100.0	89.0	3.3	7.0	4.0	1.49
	104.775	36.512	36.512	28.575	3.5	3.3	158	202	3800	5100	59200	59412	9.7	0.40	1.49	0.82	61.0	68.0	3.5	99.0	92.0	3.3	7.0	4.0	1.39
	104.775	39.688	40.157	33.338	3.5	3.3	167	237	3800	5100	4580	4535	12.4	0.34	1.79	0.98	61.0	67.0	3.5	99.0	90.0	3.3	7.5	4.5	1.61
51.592	88.900	20.638	22.225	16.513	2.0	1.3	79.5	95.8	4400	5800	368S	362A	4.3	0.32	1.88	1.03	56.0	59.0	2.0	84.0	81.0	1.3	5.5	5.0	0.49
	92.075	24.608	25.400	19.845	3.5	0.8	91.6	130	4200	5600	28584	28521	4.8	0.38	1.59	0.87	58.0	65.0	3.5	87.0	83.0	0.8	5.0	3.5	0.66
	104.775	30.162	29.317	24.605	1.5	3.3	126	166	3700	4900	468	453X	7.1	0.34	1.79	0.98	60.0	62.0	1.5	98.0	92.0	3.3	5.5	3.0	1.12
53.975	88.900	19.050	19.050	13.492	2.3	2.0	60.6	81.8	4200	5600	LM806649	LM806610	-2.3	0.55	1.10	0.68	60.0	63.0	2.3	85.0	80.0	2.0	5.5	4.0	0.42
	95.250	27.783	28.575	22.225	1.5	0.8	120	161	4100	5400	33895	33822	7.6	0.33	1.82	1.00	60.0	63.0	1.5	90.0	86.0	0.8	6.5	5.5	0.79
	104.775	30.162	29.317	24.605	3.5	3.3	126	166	3700	4900	456	453X	7.1	0.34	1.79	0.98	61.0	68.0	3.5	98.0	92.0	3.3	5.5	3.0	1.1
	104.775	36.512	36.512	28.575	3.5	3.3	159	223	3800	5100	HM807049	HM807010	7.4	0.49	1.23	0.68	63.0	73.0	3.5	100.0	89.0	3.3	7.0	4.0	1.41
	104.775	39.688	40.157	33.338	3.5	3.3	167	237	3800	5100	4595	4535	12.3	0.34	1.79	0.98	63.0	70.0	3.5	99.0	90.0	3.3	7.5	4.5	1.54
	107.950	36.512	36.957	28.575	3.5	3.3	159	206	3800	5100	539	532X	12.2	0.30	2.02	1.11	61.0	68.0	3.5	100.0	94.0	3.3	8.0	4.0	1.44
	107.950	36.512	36.957	28.575	5.5	3.3	159	161	3800	5100	539A	539A	12.2	0.30	2.02	1.11	61.0	72.0	5.5	100.0	94.0	3.3	8.0	4.0	1.43
	117.475	33.338	31.750	23.812	3.5	3.3	138	166	3500	4600	66212	66462	0.3	0.63	0.96	0.53	67.0	73.0	3.5	110.0	100.0	3.3	7.0	3.0	1.58
	120.650	41.275	41.275	31.750	3.5	3.3	192	244	3500	4600	621	612	14.0	0.31	1.91	1.05	63.0	70.0	3.5	110.0	105.0	3.3	8.5	5.0	2.18
	122.238	33.338	31.750	23.812	3.5	3.3	143	178	3300	4300	66584	66520	-2.0	0.67	0.90	0.5	68.0	75.0	3.5	116.0	105.0	3.3	7.0	3.0	1.78
	122.238	43.658	43.764	36.512	3.5	3.3	219	327	3200	4300	5578	5535	12.2	0.36	1.67	0.92	67.0	73.0	3.5	116.0	106.0	3.3	7.5	4.0	2.59
	123.825	36.512	32.791	25.400	3.5	3.3	167	208	2900	4000	72212C	72487	-2.0	0.74	0.81	0.45	67.0	79.0	3.5	116.0	102.0	3.3	8.0	3.5	2.12
	123.825	38.100	36.678	30.162	3.5	3.3	177	248	3200	4200	557S	552A	9.4	0.35	1.73	0.95	65.0	71.0	3.5	116.0	109.0	3.3	7.5	2.5	2.22
	127.000	44.450	44.450	34.925	3.5	3.3	225	297	3300	4400	65212	65500	9.4	0.49	1.23	0.68	71.0	77.0	3.5	119.0	107.0	3.3	8.5	4.0	2.86
130.175	36.512	33.338	23.812	3.5	3.3	154	183	2600	3700	HM911242	HM911212	-5.3	0.82	0.73	0.40	74.0	79.0	3.5	123.6	109.0	3.3	8.5	4.0	2.22	
54.988	104.775	30.162	29.317	24.605	2.3	3.3	126	166	3700	4900	466	453X	7.1	0.34	1.79	0.98	62.0	66.0	2.3	98.0	92.0	3.3	5.5	3.0	1.08
54.991	135.755	53.975	56.007	44.450	3.5	3.3	298	404	3000	4000	6381	6320	19.3	0.32	1.85	1.02	70.0	76.0	3.5	126.0	117.0	3.3	9.0	6.0	4.08
55.000	90.000	23.000	23.000	18.500	1.5	0.5	85.0	123	4200	5500	JLM506849	JLM506810	2.8	0.40	1.49	0.82	61.0	63.0	1.5	86.0	82.0	0.5	5.0	3.5	0.55
	95.000	29.000	29.000	23.500	1.5	2.5	121	168	4000	5300	JM207049	JM207010	7.6	0.33	1.79	0.98	62.0	64.0	1.5	91.0	85.0	2.5	6.5	4.5	0.84
	96.838	21.000	21.946	15.875	2.3	0.8	84.2	108	3900	5200	385	382A	3.0	0.35	1.69	0.93	61.0	65.0	2.3	92.0	89.0	0.8	6.0	5.5	0.61
	96.838	21.000	21.946	15.875	3.5	0.8	84.2	108	3900	5200	385X	382A	3.0	0.35	1.69	0.93	61.0	67.0	3.5	92.0	89.0	0.8	6.0	5.5	0.61
	110.000	39.000	39.000	32.000	3.0	2.5	194	251	3600	4900	JH307749	JH307710	11.7	0.35	1.73	0.95	64.0	71.0	3.0	104.0	97.0	2.5	9.0	6.0	1.69
55.562	97.630	24.608	24.608	19.446	3.5	0.8	96.3	142	3900	5200	28680	28622	3.4	0.40	1.49	0.82	62.0	68.0	3.5	92.0	88.0	0.8	5.0	4.0	0.75
	127.000	36.512	36.512	26.988	3.5	3.3	179	256	3000	4000	HM813840	HM813810	3.8	0.50	1.20	0.68	70.0	76.0	3.5	121.0	111.0	3.3	8.0	4.0	2.73
55.575	96.838	21.000	21.946	15.875	2.3	0.8	84.2	108	3900	5200	389	382A	3.0	0.35	1.69	0.93	61.0	65.0	2.3	92.0	89.0	0.8	6.0	5.5	0.60

Remarks: 1.) When a is negative, it represents that the useful load center on the outer side of the bearing
2.)** represents that the inner race adopts compound fillet.

06 | Tapered Roller Bearing

Single row taper roller bearing

Inch Series

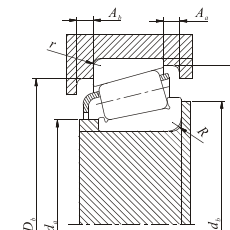
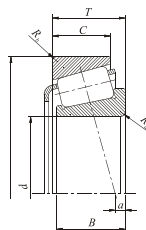

d 57.150~61.912mm

d	Main Dimension (mm)					Basic Load Rating (kN)		Limit Speed (r/min)		Bearing No.		Load center mm a ¹⁾	Constant e	Axial load coefficient		Mounting dimensions (mm)							Weight (kg)		
	D	T	B	C	(R _a) min	(R _b) min	C _r	C _{or}	Grease Lubrication	Oil Lubrication	Cone			Cup	Y ₁	Y ₀	Shaft			Bearing housing				Retainer	
57.150	96.838	21.000	21.946	15.875	2.3	0.8	84.2	108	3900	5200	387	382A	3.0	0.35	1.69	0.93	62.0	66.0	2.3	92.0	89.0	0.8	6.0	5.5	0.58
	96.838	21.000	21.946	15.875	3.5	0.8	84.2	108	3900	5200	387A	382A	3.0	0.35	1.69	0.93	62.0	69.0	3.5	92.0	89.0	0.8	6.0	5.5	0.57
	96.838	21.000	21.946	15.875	5.0	0.8	84.2	108	3900	5200	387AS	382A	3.0	0.35	1.69	0.93	62.0	72.0	5.0	92.0	89.0	0.8	6.0	5.5	0.56
	96.838	21.000	21.946	15.875	0.8	0.8	84.2	108	3900	5200	387S	382A	3.0	0.35	1.69	0.93	62.0	63.0	0.8	92.0	89.0	0.8	6.0	5.5	0.58
	98.425	21.000	21.946	17.826	3.5	0.8	84.2	108	3900	5200	387A	382	3.0	0.35	1.69	0.93	62.0	69.0	3.5	92.0	90.0	0.8	4.0	4.5	0.62
	104.775	30.162	29.317	24.605	2.3	3.3	126	166	3700	4900	462	453X	7.1	0.34	1.79	0.98	63.0	67.0	2.3	98.0	92.0	3.3	5.5	3.0	1.04
	104.775	30.162	29.317	24.605	3.5	3.3	126	166	3700	4900	469	453X	7.1	0.34	1.79	0.98	63.0	70.0	3.5	98.0	92.0	3.3	5.5	3.0	1.03
	104.775	30.162	30.958	23.812	6.4	0.8	142	189	3700	4900	45291	45221	8.1	0.33	1.80	0.99	65.0	76.0	6.4	99.0	95.0	0.8	6.5	5.0	1.06
	112.712	30.162	30.048	23.812	3.5	3.3	129	191	3400	4500	3979	3920	4.6	0.40	1.49	0.82	66.0	72.0	3.5	106.0	99.0	3.3	6.5	3.5	1.36
	112.712	30.162	30.162	23.812	3.5	3.3	155	224	3300	4500	39580	39520	6.6	0.34	1.77	0.97	66.0	72.0	3.5	107.0	101.0	3.3	7.0	5.0	1.37
	112.712	30.162	30.162	23.812	8.0	3.3	155	224	3300	4500	39581	39520	6.6	0.34	1.77	0.97	66.0	81.0	8.0	107.0	101.0	3.3	7.0	5.0	1.33
	117.475	30.162	30.162	23.812	3.5	3.3	128	197	3200	4200	33225	33462	2.8	0.44	1.38	0.76	68.0	74.0	3.5	112.0	104.0	3.3	6.5	3.5	1.53
	120.650	41.275	41.275	31.750	3.5	3.3	192	244	3500	4600	623	612	14.0	0.31	1.91	1.05	66.0	72.0	3.5	110.0	105.0	3.3	8.5	5.0	2.09
	123.825	36.512	32.791	25.400	3.5	3.3	167	208	2900	4000	72225C	72487	-2.0	0.74	0.81	0.45	67.0	81.0	3.5	116.0	102.0	3.3	8.0	3.5	2.05
	127.000	44.450	44.450	34.925	3.5	3.3	225	297	3300	4400	65225	65500	9.4	0.49	1.23	0.68	71.0	80.0	3.5	119.0	107.0	3.3	8.5	4.0	2.68
140.030	36.512	33.236	23.520	3.5	2.3	158	193	2500	3500	78225	78551	-7.9	0.87	0.69	0.38	77.0	83.0	3.5	132.0	117.0	2.3	9.0	4.0	2.56	
57.531	96.838	21.000	21.946	15.875	3.5	0.8	84.2	108	3900	5200	388A	382A	3.0	0.35	1.69	0.93	63.0	69.0	3.5	92.0	89.0	0.8	6.0	5.5	0.57
59.972	122.238	33.338	31.750	23.812	0.8	3.3	143	178	3300	4300	66589	66520	-2.0	0.67	0.90	0.50	73.0	74.0	0.8	116.0	105.0	3.3	7.0	3.0	1.65
60.000	95.000	24.000	24.000	19.000	5.0	2.5	90.4	135	3900	5200	JLM508748	JLM508710	2.8	0.40	1.49	0.82	66.0	75.0	5.0	91.0	85.0	2.5	5.5	3.5	0.63
	107.950	25.400	25.400	19.050	3.5	3.3	102	158	3300	4400	29580	29520	0.8	0.46	1.31	0.72	68.0	75.0	3.5	103.0	96.0	3.3	6.0	3.0	0.84
	110.000	22.000	21.996	18.824	0.8	1.3	91.6	126	2500	3500	397	394A	0.8	0.4	1.49	0.82	68.0	69.0	0.8	104.0	101.0	1.3	4.0	4.5	0.89
60.325	100.000	25.400	25.400	19.845	3.5	3.3	98.2	149	3700	4900	28985	28921	2.5	0.43	1.41	0.78	67.0	73.0	3.5	96.00	89.00	3.3	5.5	3.0	0.75
	101.600	25.400	25.400	19.845	3.5	3.3	98.2	149	3700	4900	28985	28920	2.5	0.43	1.41	0.78	67.0	73.0	3.5	97.00	90.00	3.3	5.5	3.0	0.79
	122.238	43.658	43.764	36.512	3.5	3.3	219	327	3200	4300	5583	5535	12.2	0.36	1.67	0.92	72.0	78.0	3.5	116.0	106.0	3.3	7.5	4.0	2.40
	127.000	36.512	36.512	26.988	3.5	3.3	179	256	3000	4000	HM813841	HM813810	3.8	0.50	1.20	0.66	73.0	80.0	3.5	121.0	111.0	3.3	8.0	4.0	2.61
	127.000	36.512	36.512	26.988	1.5	3.3	179	256	3000	4000	HM813841A	HM813810	3.8	0.50	1.20	0.66	73.0	76.0	1.5	121.0	111.0	3.3	8.0	4.0	2.61
	127.000	44.450	44.450	34.925	3.5	3.3	225	297	3300	4400	65237	65500	9.4	0.49	1.23	0.68	71.0	82.0	3.5	119.0	107.0	3.3	8.5	4.0	2.66
	127.000	44.450	44.450	34.925	1.5	3.3	225	297	3300	4400	65237A	65500	9.4	0.49	1.23	0.68	71.0	78.0	1.5	119.0	107.0	3.3	8.5	4.0	2.59
	130.175	36.512	33.338	23.812	5.0	3.3	154	183	2600	3700	HM911245	HM911210	-5.3	0.82	0.73	0.40	74.0	87.0	5.0	124.0	109.0	3.3	8.5	4.0	2.06
	136.525	46.038	46.038	36.512	3.5	3.3	249	405	2800	3700	H715332	H715311	8.6	0.47	1.27	0.70	78.0	84.0	3.5	132.0	118.0	3.3	8.0	4.5	3.55
61.912	110.000	22.000	21.996	18.824	0.8	1.3	91.6	126	3400	4500	392	394A	0.8	0.40	1.49	0.82	69.0	70.0	0.8	104.5	101.0	1.3	4.0	4.5	0.86
	130.175	36.512	33.338	23.812	3.5	3.3	154	183	2600	3700	HM911249	HM911210	-5.3	0.82	0.73	0.40	74.0	85.0	3.5	123.6	109.0	3.3	8.5	4.0	2.03
	146.050	41.275	39.688	25.400	3.5	3.3	213	256	2300	3300	H913842	H913810	-4.3	0.78	0.77	0.42	82.0	90.0	3.5	138.0	124.0	3.3	11.0	5.5	3.11

Remarks: 1.) When a is negative, it represents that the useful load center on the outer side of the bearing
2.)** represents that the inner race adopts compound fillet.

06 | Tapered Roller Bearing

Single row taper roller bearing

Inch Series

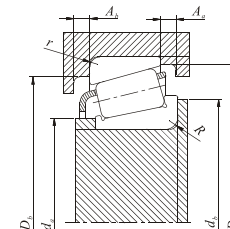
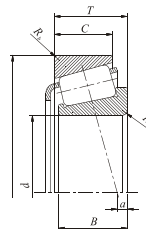

d 63.500~66.675mm

d	Main Dimension (mm)					Basic Load Rating (kN)		Limit Speed (r/min)		Bearing No.		Load center mm a ¹⁾	Constant e	Axial load coefficient		Mounting dimensions (mm)						Weight (kg)			
	D	T	B	C	(R _a) min	(R _b)	C _r	C _{0r}	Grease Lubrication	Oil Lubrication	Cone			Cup	Y ₁	Y ₀	Shaft			Bearing housing			Retainer		
																	d _a	d _b	RMax	D _a	D _b		rMax	A _a	A _b
63.500	107.950	25.400	25.400	19.050	1.5	3.3	102	158	3400	4500	29586	29520	0.8	0.46	1.31	0.72	71.0	73.0	1.5	103.0	96.0	3.3	6.0	3.0	0.92
	110.000	22.000	21.996	18.824	1.5	1.3	91.6	126	3400	4500	390A	394A	0.8	0.40	1.49	0.82	70.0	73.0	1.5	104.0	101.0	1.3	4.0	4.5	0.83
	110.000	22.000	21.996	18.824	3.5	1.3	91.6	126	3400	4500	395	394A	0.8	0.40	1.49	0.82	70.0	77.0	3.5	104.0	101.0	1.3	4.0	4.5	0.82
	110.000	25.400	25.400	19.050	3.5	1.3	102	158	3400	4500	29585	29521	0.8	0.46	1.31	0.72	71.0	77.0	3.5	104.0	99.0	1.3	6.0	3.0	0.98
	112.712	30.162	30.162	23.812	3.5	3.3	155	224	3300	4500	39585	39520	0.8	0.46	1.31	0.97	71.0	77.0	3.5	107.0	101.0	3.3	7.0	5.0	1.22
	120.000	29.794	29.007	24.237	0.8	2.0	133	186	3200	4200	477	472	4.1	0.38	1.56	0.86	72.0	73.0	0.8	114.0	107.0	2.0	6.5	4.0	1.46
	122.238	38.100	38.354	29.718	3.5	3.3	209	279	3200	4300	HM212046	HM212011	10.9	0.34	1.78	0.98	73.0	80.0	3.5	116.0	108.0	3.3	9.0	6.5	1.94
	122.238	43.658	43.764	36.512	3.5	3.3	219	327	3200	4300	5584	5535	12.2	0.36	1.67	0.92	75.0	81.0	3.5	116.0	106.0	3.3	7.5	4.0	2.29
	127.000	36.512	36.170	28.575	3.5	3.3	182	263	3000	4000	565	563	8.1	0.36	1.65	0.91	73.0	80.0	3.5	120.0	112.0	3.3	7.5	4.0	2.08
	135.775	53.975	56.007	44.450	4.3	3.3	298	404	3000	4000	6382	6320	19.3	0.32	1.85	1.02	77.0	84.0	4.3	126.0	117.0	3.3	9.0	6.0	3.68
136.525	36.512	33.236	23.520	2.3	3.3	158	193	2500	3500	78250	78537	-7.9	0.87	0.69	0.38	79.0	85.0	2.3	130.0	115.0	3.3	9.0	4.0	2.26	
136.525	41.275	41.275	31.750	3.5	3.3	252	335	2900	3800	H414235	H414210	10.9	0.36	1.67	0.92	78.0	82.0	3.5	129.0	121.0	3.3	9.0	6.0	2.91	
64.986	112.712	30.162	30.924	23.812	2.3	3.3	155	224	3300	4500	39586	39520	6.6	0.34	1.77	0.97	72.0	76.0	2.3	107.0	101.0	3.3	7.0	5.0	1.20
65.000	105.000	24.000	23.000	18.500	3.0	1.0	100	139	3500	4700	JLM710949	JLM710910	0.3	0.45	1.32	0.73	71.0	77.0	3.0	101.0	96.0	1.0	6.5	4.0	0.72
	110.000	28.000	28.000	22.500	3.0	2.5	131	195	3400	4600	JM511946	JM511910	3.3	0.40	1.49	0.82	72.0	78.0	3.0	105.0	99.0	2.5	6.5	4.5	1.05
	120.000	39.000	38.500	32.000	3.0	2.5	207	283	3200	4300	JH211749	JH211710	10.7	0.34	1.78	0.98	74.0	80.0	3.0	114.0	107.0	2.5	9.0	6.0	1.86
	120.000	39.000	38.500	32.000	7.0	2.5	207	283	3200	4300	JH211749A	JH211710	10.7	0.34	1.78	0.98	74.0	88.0	7.0	114.0	107.0	2.5	9.0	6.0	1.83
65.088	135.755	53.975	56.007	44.450	3.5	3.3	298	404	3000	4000	6379	6320	19.3	0.32	1.85	1.02	77.0	84.0	3.5	126.0	117.0	3.3	9.0	6.0	3.61
	136.525	46.038	46.038	36.512	3.5	3.3	249	405	2800	3700	H715340	H7154311	8.6	0.47	1.27	0.70	82.0	88.0	3.5	132.0	118.0	3.3	8.0	4.5	3.38
65.883	122.238	43.658	43.764	36.512	3.5	3.3	219	327	3200	4300	5595	5535	12.2	0.36	1.67	0.92	77.0	83.0	3.5	116.0	106.0	3.3	7.5	4.0	2.21
66.675	110.000	22.000	21.996	18.824	0.8	1.3	91.6	126	3400	4500	395A	394A	0.8	0.40	1.49	0.82	73.0	73.0	0.8	104.0	101.0	1.3	4.0	4.5	1.06
	110.000	22.000	21.996	18.824	3.5	1.3	91.6	126	3400	4500	395S	394A	0.8	0.40	1.49	0.82	73.0	79.0	3.5	104.0	101.0	1.3	4.0	4.5	0.78
	112.712	30.162	30.048	23.812	3.5	0.8	129	191	3400	4500	3984	3925	4.6	0.40	1.49	0.82	74.0	80.0	3.5	106.0	101.0	0.8	6.5	3.5	1.14
	112.712	30.162	30.162	23.812	3.5	3.3	155	224	3300	4500	39590	39520	6.6	0.34	1.77	0.97	74.0	80.0	3.5	107.0	101.0	3.3	7.0	5.0	1.13
	112.712	30.162	30.162	23.812	3.5	0.8	155	224	3300	4500	39590	39521	6.6	0.34	1.77	0.97	74.0	80.0	3.5	107.0	103.0	0.8	7.0	5.0	1.15
	122.238	38.100	38.354	29.718	3.5	1.5	209	279	3200	4300	HM212049	HM212010	10.9	0.34	1.78	0.98	75.0	82.0	3.5	116.0	110.0	1.5	9.0	6.5	1.85
	127.000	36.512	36.512	26.988	3.5	1.5	179	256	3000	4000	HM813844	HM813811	3.8	0.50	1.20	0.66	78.0	85.0	3.5	121.0	113.0	1.5	8.0	4.0	1.99
	130.175	41.275	41.275	31.750	3.5	3.3	216	298	3000	3900	641	633	11.2	0.36	1.66	0.91	77.0	83.0	3.5	124.0	116.0	3.3	8.5	5.0	2.38
	135.755	53.975	56.007	44.450	4.3	3.3	298	404	3000	4000	6386	6320	19.3	0.32	1.85	1.02	77.0	87.0	4.3	126.0	117.0	3.3	9.0	6.0	3.54
	135.755	53.975	56.007	44.450	6.4	3.3	298	404	3000	4000	6389	6320	19.3	0.32	1.85	1.02	77.0	91.0	6.4	126.0	117.0	3.3	9.0	6.0	3.52
	136.525	41.275	41.275	31.750	3.5	3.3	252	335	2900	3800	H414242	H414210	10.9	0.36	1.67	0.92	81.0	85.0	3.5	129.0	121.0	3.3	9.0	6.0	2.81
	136.525	46.038	46.038	36.512	3.5	3.3	252	335	2800	3700	H715341	H715311	8.6	0.47	1.27	0.70	84.0	90.0	3.5	132.0	118.0	3.3	8.0	4.5	3.26
	177.800	57.150	53.975	37.308	3.5	3.3	352	413	2100	2900	HH914449	HH914442	0.3	0.80	0.75	0.41	85.0	106.0	3.5	165.0	146.0	3.3	14.0	6.0	6.73

Remarks: 1.) When a is negative, it represents that the useful load center on the outer side of the bearing
2.)** represents that the inner race adopts compound fillet.

06 | Tapered Roller Bearing

Single row taper roller bearing

Inch Series

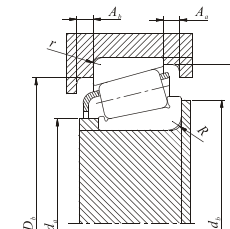
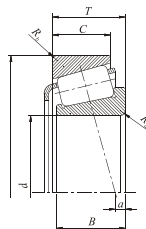

d 68.262~70.000mm

d	Main Dimension (mm)					Basic Load Rating (kN)		Limit Speed (r/min)		Bearing No.		Load center mm a ¹⁾	Constant e	Axial load coefficient		Mounting dimensions (mm)						Weight (kg)			
	D	T	B	C	(Ra) min	(Rb) min	C _r	C _{0r}	Grease Lubrication	Oil Lubrication	Cone			Cup	Y ₁	Y ₀	Shaft		Bearing housing				Retainer		
68.262	110.000	22.000	21.996	18.824	2.3	1.3	91.6	126	3400	4500	399A	394A	0.8	0.40	1.49	0.82	d _a 74.0	d _b 78.0	RMax 2.3	D _a 104.0	D _b 101.0	rMax 1.3	A _a 4.0	A _b 4.5	0.74
	110.000	22.000	21.996	18.824	5.0	1.3	91.6	126	3400	4500	399AS	94A	0.8	0.40	1.49	0.82	74.0	83.0	5.0	104.0	101.0	1.3	4.0	4.5	0.72
	117.745	30.162	30.162	23.812	3.5	3.3	128	197	3200	4200	33269	33462	2.8	0.44	1.38	0.76	76.0	82.0	3.5	112.0	104.0	3.3	6.5	3.5	1.29
	127.000	36.512	36.170	28.575	3.5	3.3	182	263	3000	4000	570	563	8.1	0.36	1.65	0.91	77.0	83.0	3.5	120.0	112.0	3.3	7.5	4.0	1.94
	136.525	41.275	41.275	31.750	3.5	3.3	252	335	2900	3800	H414245	H414210	10.9	0.36	1.67	0.92	82.0	86.0	3.5	129.0	121.0	3.3	9.0	6.0	2.75
	136.525	46.038	46.038	36.512	3.5	3.3	249	405	2800	3700	H715343	H715311	8.6	0.47	1.27	0.70	84.0	90.0	3.5	132.0	118.0	3.3	8.0	4.5	3.26
	152.400	47.625	46.038	31.750	3.5	3.3	264	306	2700	3600	9185	9121	3.8	0.66	0.91	0.50	81.0	94.0	3.5	145.0	130.0	3.3	11.5	6.5	3.83
	161.925	49.212	46.038	31.750	3.5	3.3	275	330	2100	2900	9278	9220	0.0	0.71	0.85	0.47	90.4	97.0	3.5	153.0	138.0	3.3	12.0	4.5	4.64
69.850	99.271	17.000	16.000	13.000	1.5	1.5	45.2	75.0	3500	4700	LL713149	LL713110	-4.6	0.46	1.29	0.75	75.0	77.0	1.5	95.0	91.0	1.5	5.0	1.0	0.38
	112.712	22.225	21.996	15.875	1.5	0.8	93.4	131	3300	4400	LM613449	LM613410	0.0	0.42	1.44	0.79	76.0	78.0	1.5	107.0	104.0	0.8	7.0	4.5	0.77
	112.712	25.400	25.400	19.050	1.5	3.3	102	166	3200	4300	29675	29620	-1.0	0.49	1.23	0.68	77.0	80.0	1.5	109.0	101.0	3.3	6.0	3.5	0.95
	117.745	30.162	30.162	23.812	3.5	3.3	128	197	3200	4200	33275	33462	2.8	0.44	1.38	0.76	77.0	84.0	3.5	112.0	104.0	3.3	6.5	3.5	1.25
	120.000	29.002	29.007	23.444	3.5	3.3	133	186	3200	4200	482	472A	4.1	0.38	1.56	0.86	77.0	83.0	3.5	114.0	106.0	3.3	6.5	5.0	1.27
	120.000	29.794	29.007	24.237	3.5	2.0	133	186	3200	4200	482	472	4.1	0.38	1.56	0.86	77.0	83.0	3.5	114.0	107.0	2.0	6.5	4.0	1.30
	120.000	32.545	32.545	26.195	3.5	3.3	166	249	3100	4200	47487	47420	6.4	0.36	1.67	0.92	78.0	84.0	3.5	114.0	107.0	3.3	6.5	4.0	1.46
	120.650	32.545	32.545	26.195	3.5	0.5	166	249	3100	4200	47487	47420A	6.4	0.36	1.67	0.92	78.0	84.0	3.5	114.0	109.0	0.5	6.5	4.0	1.47
	127.000	36.512	36.170	28.575	3.5	3.3	182	263	3000	4000	566	563	8.1	0.36	1.65	0.91	78.0	85.0	3.5	120.0	112.0	3.3	7.5	4.0	1.89
	146.050	41.275	39.688	25.400	3.5	3.3	213	256	2300	3300	H913849	H913810	-4.3	0.78	0.77	0.42	82.0	95.0	3.5	138.0	124.0	3.3	11.0	5.5	2.85
	146.050	41.275	41.275	31.750	3.5	3.3	229	335	2600	3400	655	653	7.9	0.41	1.47	0.81	82.0	88.0	3.5	139.0	131.0	3.3	8.0	5.0	3.24
	150.089	44.450	46.672	36.512	3.5	3.3	294	417	2500	3400	745A	742	11.9	0.33	1.84	1.01	82.0	88.0	3.5	142.0	134.0	3.3	9.5	7.0	3.88
168.275	53.975	56.363	41.275	3.5	3.3	379	522	2300	3100	835	832	18.5	0.30	2.00	1.10	84.0	91.0	3.5	155.0	149.0	3.3	11.0	7.5	6.15	
69.952	121.442	24.608	23.012	17.462	2.0	2.0	94.6	137	3000	4000	34274	34478	-1.5	0.45	1.33	0.73	78.0	81.0	2.0	116.0	110.0	2.0	7.0	3.0	1.08
70.000	110.000	26.000	25.000	20.500	1.0	2.5	106	168	3300	4400	JLM812049	JLM813010	-0.3	0.49	1.23	0.68	77.0	78.0	1.0	105.0	98.0	2.5	6.0	4.0	0.88
	115.000	29.000	29.000	23.000	3.0	2.5	139	198	3200	4300	JM612949	JM612910	2.5	0.43	1.39	0.77	77.0	83.0	3.0	110.0	103.0	2.5	7.5	5.0	1.13

Remarks: 1.) When a is negative, it represents that the useful load center on the outer side of the bearing
2.)** represents that the inner race adopts compound fillet.

Spherical Roller Bearings feature a large load rating capacity and self-aligning capability. The spherical roller bearing is also ideal for low or medium speed applications which involve heavy or impact loading.

DPI Spherical Roller Bearings are made under the most stringent quality benchmarks. Our large range of bearings provides you with all the requirements that you need for your industrial needs. The standard cages used are pressed steel cages or with copper alloy machined cage. For details on boundary dimensions and specifications please refer to the tables overleaf.

Spherical Roller Bearing



07 | Spherical Roller Bearing

Spherical Roller Bearing

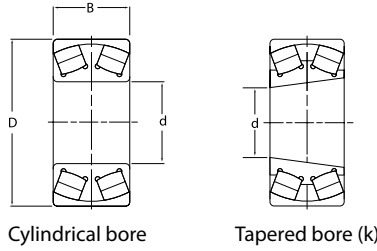

d 20.0~60.0mm

Boundary dimensions (mm)			Basic load ratings(kN)		Speed ratings (rpm)		Bearing No.		Weight (kg)
d	D	B	Dynamic C _r	Static C _{or}	Grease	Oil	Cylindrical bore	Tapered bore	
20.0	52.0	15.0	34.0	33.5	7300	9000	21304CCW33	21304CCKW33	0.18
25.0	52.0	18.0	45.5	48.0	7000	9000	22205MBW33	22205MBKW33	0.19
	52.0	18.0	45.5	48.0	7000	9000	22205CCW33	22205CCKW33	0.19
	62.0	17.0	46.0	47.5	6200	7800	21305CCW33	21305CCKW33	0.29
30.0	62.0	20.0	61.0	65.0	6000	7500	22206MBW33	22206MBKW33	0.30
	62.0	20.0	61.0	65.0	6000	7500	22206CCW33	22206CCKW33	0.30
	72.0	19.0	59.5	62.5	5300	6600	21306CCW33	21306CCKW33	0.43
35.0	72.0	23.0	80.5	88.5	5000	6300	22207MBW33	22207MBKW33	0.46
	72.0	23.0	80.5	88.5	5000	6300	22207CCW33	22207CCKW33	0.46
	80.0	21.0	69.5	76.0	4700	5900	21307CCW33	21307CCKW33	0.57
	80.0	31.0	104.0	107.0	6000	7700	22307MBW33	22307MBKW33	0.78
40.0	80.0	23.0	90.5	102.0	4500	5600	22208MBW33	22208MBKW33	0.56
	80.0	23.0	90.5	102.0	4500	5600	22208CCW33	22208CCKW33	0.56
	90.0	23.0	85.5	95.5	4000	5200	21308CCW33	21308CCKW33	0.78
	90.0	33.0	135.0	151.0	4000	5300	22308CCW33	22308CCKW33	1.07
	90.0	33.0	135.0	151.0	4000	5300	22308MBW33	22308MBKW33	1.07
45.0	85.0	23.0	95.5	110.0	4300	5300	22209MBW33	22209MBKW33	0.61
	85.0	23.0	95.5	110.0	4300	5300	22209CCW33	22209CCKW33	0.61
	100.0	25.0	108.0	124.0	3700	4600	21309CCW33	21309CCKW33	1.05
	100.0	36.0	165.0	182.0	3500	4800	22309CCW33	22309CCKW33	1.41
	100.0	36.0	165.0	182.0	3500	4800	22309MBW33	22309MBKW33	1.41
50.0	90.0	23.0	102.0	122.0	3800	4800	22210MBW33	22210MBKW33	0.65
	90.0	23.0	102.0	122.0	3800	4800	22210CCW33	22210CCKW33	0.65
	110.0	27.0	128.0	151.0	3300	4200	21310CCW33	21310CCKW33	1.36
	110.0	40.0	203.0	235.0	3200	4300	22310CCW33	22310CCKW33	1.92
	110.0	40.0	203.0	235.0	3200	4300	22310MBW33	22310MBKW33	1.92
55.0	100.0	25.0	123.0	144.0	3400	4300	22211MBW33	22211MBKW33	0.88
	100.0	25.0	123.0	144.0	3400	4300	22211CCW33	22211CCKW33	0.88
	120.0	29.0	144.0	165.0	3000	4100	21311CCW33	21311CCKW33	1.70
	120.0	43.0	235.0	263.0	3000	3800	22311CCW33	22311CCKW33	2.40
	120.0	43.0	235.0	263.0	3000	3800	22311MBW33	22311MBKW33	2.40
	120.0	43.0	235.0	263.0	3000	3800			
60.0	110.0	28.0	151.0	179.0	3200	4000	22212MBW33	22212MBKW33	1.20
	110.0	28.0	151.0	179.0	3200	4000	22212CCW33	22212CCKW33	1.20
	130.0	31.0	168.0	193.0	2800	3700	21312CCW33	21312CCKW33	2.10
	130.0	46.0	281.0	330.0	2800	3600	22312CCW33	22312CCKW33	3.05
	130.0	46.0	281.0	330.0	2800	3600	22312MBW33	22312MBKW33	3.05

Spherical Roller Bearing

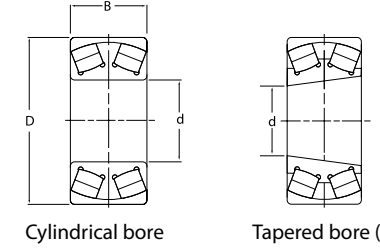

d 65.0~95.0mm

Boundary dimensions (mm)			Basic load ratings(kN)		Speed ratings (rpm)		Bearing No.		Weight (kg)
d	D	B	Dynamic C _r	Static C _{or}	Grease	Oil	Cylindrical bore	Tapered bore	
65.0	120.0	31.0	177.0	209.0	2800	3600	22213MBW33	22213MBKW33	1.56
	120.0	31.0	177.0	209.0	2800	3600	22213CCW33	22213CCKW33	1.56
	140.0	33.0	194.0	232.0	2600	3400	21313CCW33	21313CCKW33	2.60
	140.0	48.0	300.0	355.0	2400	3200	22313CCW33	22313CCKW33	3.67
	140.0	48.0	300.0	355.0	2400	3200	22313MBW33	22313MBKW33	3.67
70.0	125.0	31.0	185.0	220.0	2600	3400	22214MBW33	22214MBKW33	1.65
	125.0	31.0	185.0	220.0	2600	3400	22214CCW33	22214CCKW33	1.65
	150.0	35.0	215.0	260.0	2400	3200	21314CCW33	21314CCKW33	3.10
75.0	150.0	51.0	345.0	415.0	2200	3000	22314CCW33	22314CCKW33	4.45
	150.0	51.0	345.0	415.0	2200	3000	22314MBW33	22314MBKW33	4.45
	130.0	31.0	191.0	234.0	2400	3200	22215MBW33	22215MBKW33	1.74
80.0	130.0	31.0	191.0	234.0	2400	3200	22215CCW33	22215CCKW33	1.74
	160.0	37.0	245.0	298.0	2200	3000	21315CCW33	21315CCKW33	3.80
	160.0	55.0	395.0	475.0	2000	2800	22315CCW33	22315CCKW33	5.44
	160.0	55.0	395.0	475.0	2000	2800	22315MBW33	22315MBKW33	5.44
	140.0	33.0	215.0	269.0	2200	3000	22216MBW33	22216MBKW33	2.19
85.0	140.0	33.0	215.0	269.0	2200	3000	22216CCW33	22216CCKW33	2.19
	140.0	44.5	241.0	335.0	2200	2900	23216MBW33	23216MBKW33	2.95
	170.0	39.0	275.0	339.0	2100	2800	21316CCW33	21316CCKW33	4.50
	170.0	58.0	430.0	520.0	1900	2600	22316CCW33	22316CCKW33	6.42
	170.0	58.0	430.0	520.0	1900	2600	22316MBW33	22316MBKW33	6.42
	150.0	36.0	255.0	320.0	2000	2800	22217MBW33	22217MBKW33	2.75
90.0	150.0	36.0	255.0	320.0	2000	2800	22217CCW33	22217CCKW33	2.75
	150.0	49.2	285.0	405.0	2100	2700	23217MBW33	23217MBKW33	3.78
	180.0	41.0	300.0	372.0	2000	2600	21317CCW33	21317CCKW33	5.30
	180.0	60.0	480.0	585.0	1800	2400	22317CCW33	22317CCKW33	7.46
	180.0	60.0	480.0	585.0	1800	2400	22317MBW33	22317MBKW33	7.46
	160.0	40.0	294.0	375.0	1900	2600	22218MBW33	22218MBKW33	3.50
	160.0	40.0	294.0	375.0	1900	2600	22218CCW33	22218CCKW33	3.50
160.0	52.4	337.0	482.0	2100	2800	23218MBW33	23218MBKW33	4.57	
95.0	190.0	43.0	330.0	410.0	1900	2500	21318CCW33	21318CCKW33	6.10
	190.0	64.0	535.0	660.0	1800	2400	22318CCW33	22318CCKW33	8.82
	190.0	64.0	535.0	660.0	1800	2400	22318MBW33	22318MBKW33	8.82
	170.0	43.0	335.0	420.0	1900	2600	22219MBW33	22219MBKW33	4.24
	170.0	43.0	335.0	420.0	1900	2600	22219CCW33	22219CCKW33	4.24
95.0	170.0	55.6	360.0	510.0	1900	2400	23219MBW33	23219MBKW33	5.46
	200.0	45.0	362.0	461.0	1800	2300	21319CCW33	21319CCKW33	7.10
	200.0	67.0	585.0	725.0	1700	2200	22319CCW33	22319CCKW33	10.20
	200.0	67.0	585.0	725.0	1700	2200	22319MBW33	22319MBKW33	10.20

07 | Spherical Roller Bearing

Spherical Roller Bearing

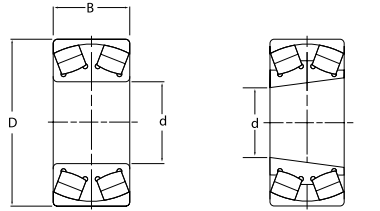

Cylindrical bore

Tapered bore (k)

d 100~120mm

Boundary dimensions (mm)			Basic load ratings(kN)		Speed ratings (rpm)		Bearing No.		Weight (kg)
<i>d</i>	<i>D</i>	<i>B</i>	Dynamic C_r	Static C_{or}	Grease	Oil	Cylindrical bore	Tapered bore	
100	165	52	287	510	2000	2800	23120MBW33	23120KMBW33	4.42
	180	60.3	400	570	1700	2200	23220MBW33	23220KMBW33	6.58
	165	65	414	582	1800	2600	24120MBW33	24120KMBW33	5.55
	165	65	414	582	1800	2600	24120CCW33	24120CCKW33	5.45
	150	50	260	377	2200	3000	24020MBW33	24020KMBW33	3.45
	150	50	260	377	2200	3000	24020CCW33	24020CCKW33	3.15
	180	46	277	425	2200	3000	22220MBW33	22220KMBW33	5.18
	180	46	277	425	2200	3000	22220CCW33	22220CCKW33	5.02
	215	73	540	815	1700	2200	22320MBW33	22320KMBW33	15.00
	215	73	540	815	1700	2200	22320CCW33	22320CCKW33	13.80
105	175	56	365	550	1900	2700	23121MBW33	23121KMBW33	5.48
110	170	45	253	460	2200	3000	23022MBW33	23022KMBW33	3.54
	170	45	253	460	2200	3000	23022CCW33	23022CCKW33	3.24
	240	50	450	580	1700	2400	21322MBW33	21322KMBW33	11.50
	180	56	325	580	1900	2600	23122MBW33	23122KMBW33	5.73
	180	56	325	580	1900	2600	23122CCW33	23122CCKW33	5.50
	200	69.8	490	720	1600	2000	23222MBW33	23222KMBW33	10.10
	200	69.8	490	720	1600	2000	23222CCW33	23222CCKW33	9.95
	180	69	425	750	1600	2000	24122MBW33	24122KMBW33	6.92
	180	69	425	750	1600	2000	24122CCW33	24122CCKW33	6.72
	170	60	378	565	1800	2500	24022MBW33	24022KMBW33	5.00
	170	60	378	565	1800	2500	24022CCW33	24022CCKW33	4.71
	200	53	345	545	2000	2800	22222MBW33	22222KMBW33	7.43
	200	53	345	545	2000	2800	22222CCW33	22222CCKW33	7.15
	240	80	630	955	1400	1800	22322MBW33	22322KMBW33	18.90
	240	80	630	955	1400	1800	22322CCW33	22322CCKW33	18.60
	120	180	46	263	495	2000	2800	23024MBW33	23024KMBW33
180		46	263	495	2000	2800	23024CCW33	23024CCKW33	4.01
200		62	405	715	1800	2400	23124MBW33	23124KMBW33	13.40
200		62	405	715	1800	2400	23124CCW33	23124CCKW33	13.10
215		76	535	940	1500	1900	23224MBW33	23224KMBW33	12.10
215		76	535	940	1500	1900	23224CCW33	23224CCKW33	11.80
200		80	495	925	900	1200	24124MBW33	24124KMBW33	10.60
200		80	495	925	900	1200	24124CCW33	24124CCKW33	10.20
180		60	325	660	1600	2000	24024MBW33	24024KMBW33	5.83
180		60	325	660	1600	2000	24024CCW33	24024CCKW33	5.52
215		58	445	735	1900	2600	22224MBW33	22224KMBW33	10.30
215		58	445	735	1900	2600	22224CCW33	22224CCKW33	10.10
260		86	780	1160	1400	1800	22324MBW33	22324KMBW33	23.80
260		86	780	1160	1400	1800	22324CCW33	22324CCKW33	23.20

Spherical Roller Bearing

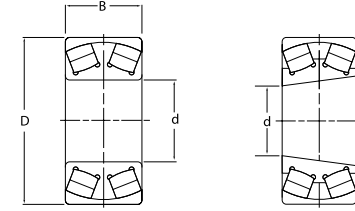

Cylindrical bore

Tapered bore (k)

d 130~150mm

Boundary dimensions (mm)			Basic load ratings(kN)		Speed ratings (rpm)		Bearing No.		Weight (kg)	
<i>d</i>	<i>D</i>	<i>B</i>	Dynamic C_r	Static C_{or}	Grease	Oil	Cylindrical bore	Tapered bore		
130	200	52	340	650	1900	2600	23026MBW33	23026KMBW33	7.04	
	200	52	340	650	1900	2600	23026CCW33	23026CCKW33	6.85	
	210	64	430	790	1700	2200	23126MBW33	23126KMBW33	9.56	
	210	64	430	790	1700	2200	23126CCW33	23126CCKW33	9.25	
	230	80	607	1020	1300	1700	23226MBW33	23226KMBW33	15.90	
	230	80	607	1020	1300	1700	23226CCW33	23226CCKW33	15.60	
	210	80	598	910	1500	1900	24126MBW33	24126KMBW33	11.00	
	210	80	598	910	1500	1900	24126CCW33	24126CCKW33	10.80	
	200	70	491	740	1700	2500	24026MBW33	24026KMBW33	8.05	
	200	71	491	740	1700	2500	24026CCW33	24026CCKW33	7.85	
140	230	64	490	805	1800	2400	22226MBW33	22226KMBW33	12.40	
	230	64	490	805	1800	2400	22226CCW33	22226CCKW33	12.10	
	280	93	840	1300	1300	1700	22326MBW33	22326KMBW33	18.30	
	280	93	840	1300	1300	1700	22326CCW33	22326CCKW33	18.10	
	150	210	53	365	705	1800	2400	23028MBW33	23028KMBW33	6.70
		210	53	365	705	1800	2400	23028CCW33	23028CCKW33	6.50
		225	68	490	935	1600	2000	23128MBW33	23128KMBW33	10.90
		225	68	490	935	1600	2000	23128CCW33	23128CCKW33	10.60
		250	88	910	1365	1200	1600	23228MBW33	23228KMBW33	19.70
		250	88	910	1365	1200	1600	23228CCW33	23228CCKW33	19.40
300		118	1300	2050	1000	1400	23328MBW33	23328KMBW33	42.20	
190		37	298	680	2200	3000	23928MBW33	23928KMBW33	3.10	
225		85	580	1150	850	1100	24128MBW33	24128KMBW33	13.50	
225		85	580	1150	850	1100	24128CCW33	24128CCKW33	13.10	
210		69	518	818	1700	2200	24028MBW33	24028KMBW33	8.55	
210		69	518	818	1700	2200	24028CCW33	24028CCKW33	8.14	
250		68	560	930	1700	2200	22228MBW33	22228KMBW33	16.20	
250		68	560	930	1700	2200	22228CCW33	22228CCKW33	15.70	
300	102	1210	1950	1100	1500	22328MBW33	22328KMBW33	35.50		
300	102	1210	1950	1100	1500	22328CCW33	22328CCKW33	35.10		
150	225	56	400	795	1700	2200	23030MBW33	23030KMBW33	7.44	
	225	56	400	795	1700	2200	23030CCW33	23030CCKW33	7.24	
	250	80	745	885	1400	1800	23130MBW33	23130KMBW33	16.90	
	250	80	745	885	1400	1800	23130CCW33	23130CCKW33	16.40	
	270	96	950	1550	1100	1500	23230MBW33	23230KMBW33	26.60	
	270	96	950	1550	1100	1500	23230CCW33	23230CCKW33	26.20	

07 | Spherical Roller Bearing

Spherical Roller Bearing

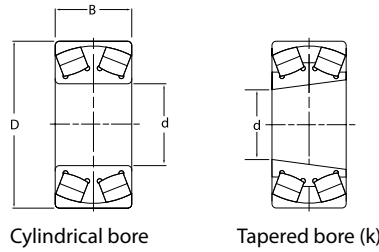

d 150~170mm

Boundary dimensions (mm)			Basic load ratings(kN)		Speed ratings (rpm)		Bearing No.		Weight (kg)	
d	D	B	Dynamic C _r	Static C _{or}	Grease	Oil	Cylindrical bore	Tapered bore		
150	250	100	928	1390	1400	1800	24130MBW33	24130KMBW33	20.20	
	250	100	928	1390	1400	1800	24130CCW33	24130CCKW33	20.00	
	225	75	500	1050	1300	1700	24030MBW33	24030KMBW33	9.39	
	225	75	500	1050	1300	1700	24030CCW33	24030CCKW33	9.11	
	270	73	630	1050	1600	2000	22230MBW33	22230KMBW33	18.70	
	270	73	630	1050	1600	2000	22230CCW33	22230CCKW33	18.20	
	320	108	1120	1810	1000	1400	22330MBW33	22330KMBW33	14.50	
	320	108	1120	1810	1000	1400	22330CCW33	22330CCKW33	14.10	
	160	240	60	445	875	1700	2200	23032MBW33	23032KMBW33	8.86
		240	60	445	875	1700	2200	23032CCW33	23032CCKW33	8.42
270		86	765	1430	1300	1700	23132MBW33	23132KMBW33	21.90	
270		86	765	1430	1300	1700	23132CCW33	23132CCKW33	21.40	
290		104	955	1770	1000	1400	23232MBW33	23232KMBW33	30.20	
290		104	955	1770	1000	1400	23232CCW33	23232CCKW33	30.00	
220		45	350	720	2000	2600	23932MBW33	23932KMBW33	5.12	
270		109	865	1690	1000	1400	24132MBW33	24132KMBW33	24.60	
270		109	865	1690	1000	1400	24132CCW33	24132CCKW33	24.20	
240		80	570	1210	1100	1500	24032MBW33	24032KMBW33	13.20	
240		80	570	1210	1100	1500	24032CCW33	24032CCKW33	13.00	
290		80	750	1300	1500	1900	22232MBW33	22232KMBW33	24.60	
290		80	750	1300	1500	1900	22232CCW33	22232CCKW33	24.30	
340		114	1270	2050	950	1300	22332MBW33	22332KMBW33	52.80	
340		114	1270	2050	950	1300	22332CCW33	22332CCKW33	52.50	
170		260	67	555	1090	1600	2000	23034MBW33	23034KMBW33	14.20
		260	67	555	1090	1600	2000	23034CCW33	23034CCKW33	14.00
		280	88	730	1390	1200	1600	23134MBW33	23134KMBW33	26.10
	280	88	730	1390	1200	1600	23134CCW33	23134CCKW33	25.60	
	310	110	1070	1930	950	1300	23234MBW33	23234KMBW33	38.00	
	310	110	1070	1930	950	1300	23234CCW33	23234CCKW33	37.50	
	230	45	400	800	1800	2400	23934MBW33	23934KMBW33	5.45	
	360	136	1420	2250	900	1200	23334MBW33	23334KMBW33	68.70	
	280	109	915	1830	1000	1400	24134MBW33	24134KMBW33	24.80	
	280	109	915	1830	1000	1400	24134CCW33	24134CCKW33	24.10	
	260	90	705	1500	1000	1400	24034MBW33	24034KMBW33	17.80	
	260	90	705	1500	1000	1400	24034CCW33	24034CCKW33	17.10	
	310	86	845	1450	1300	1700	22234MBW33	22234KMBW33	26.80	
	310	86	845	1450	1300	1700	22234CCW33	22234CCKW33	26.10	
	360	120	1320	2120	950	1300	22334MBW33	22334KMBW33	62.60	
	360	120	1320	2120	950	1300	22334CCW33	22334CCKW33	62.10	

Spherical Roller Bearing

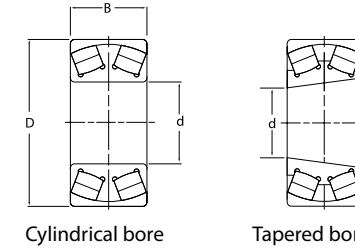

d 180~190mm

Boundary dimensions (mm)			Basic load ratings(kN)		Speed ratings (rpm)		Bearing No.		Weight (kg)
d	D	B	Dynamic C _r	Static C _{or}	Grease	Oil	Cylindrical bore	Tapered bore	
180	280	74	630	1280	1400	1800	23036MBW33	23036KMBW33	17.70
	280	74	630	1280	1400	1800	23036CCW33	23036CCKW33	17.40
	300	96	900	1720	1100	1500	23136MBW33	23136KMBW33	27.10
	300	96	900	1720	1100	1500	23136CCW33	23136CCKW33	26.60
	320	112	1160	2130	900	1200	23236MBW33	23236KMBW33	38.70
	320	112	1160	2130	900	1200	23236CCW33	23236CCKW33	38.40
	250	53	430	830	1700	2200	23936CCW33	23936CCKW33	7.34
	300	118	1020	2030	900	1200	24136MBW33	24136KMBW33	33.00
	300	118	1020	2030	900	1200	24136CCW33	24136CCKW33	32.70
	280	100	835	1750	950	1300	24036MBW33	24036KMBW33	26.60
	280	100	835	1750	950	1300	24036CCW33	24036CCKW33	26.20
	320	86	895	1550	1300	1700	22236MBW33	22236KMBW33	29.40
	320	86	895	1550	1300	1700	22236CCW33	22236CCKW33	29.10
	380	126	1470	2400	900	1200	22336MBW33	22336KMBW33	72.20
380	126	1470	2400	900	1200	22336CCW33	22336CCKW33	72.00	
190	290	75	700	1450	1300	1700	23038MBW33	23038KMBW33	17.30
	290	75	700	1450	1300	1700	23038CCW33	23038CCKW33	17.10
	320	104	975	1840	1000	1400	23138MBW33	23138KMBW33	34.30
	320	104	975	1840	1000	1400	23138CCW33	23138CCKW33	34.00
	340	120	1290	2400	850	1100	23238MBW33	23238KMBW33	44.80
	340	120	1290	2400	850	1100	23238CCW33	23238CCKW33	44.40
	260	52	550	980	1500	2000	23938MBW33	23938KMBW33	8.32
	260	52	550	980	1500	2000	23938CCW33	23938CCKW33	8.01
	320	128	1200	2400	850	1100	24138MBW33	24138KMBW33	41.90
	320	128	1200	2400	850	1100	24138CCW33	24138CCKW33	41.50
	290	100	855	1840	950	1300	24038MBW33	24038KMBW33	22.90
	290	100	855	1840	950	1300	24038CCW33	24038CCKW33	22.50
	340	92	865	1620	1200	1600	22238MBW33	22238KMBW33	37.40
	340	92	865	1620	1200	1600	22238CCW33	22238CCKW33	37.00
	400	132	1640	2630	850	1100	22338MBW33	22338KMBW33	82.20
	400	132	1640	2630	850	1100	22338CCW33	22338CCKW33	82.00

07 | Spherical Roller Bearing

Spherical Roller Bearing

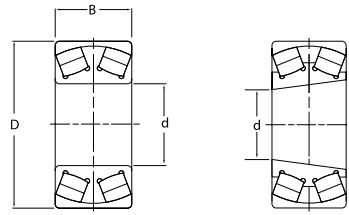

Cylindrical bore

Tapered bore (k)

d 200~220mm

Boundary dimensions (mm)			Basic load ratings(kN)		Speed ratings (rpm)		Bearing No.		Weight (kg)
d	D	B	Dynamic C _r	Static C _{or}	Grease	Oil	Cylindrical bore	Tapered bore	
200	310	82	770	1560	1200	1600	23040MBW33	23040KMBW33	22.60
	310	82	770	1560	1200	1600	23040CCW33	23040CCKW33	22.10
	340	112	1170	2240	950	1300	23140MBW33	23140KMBW33	43.80
	340	112	1170	2240	950	1300	23140CCW33	23140CCKW33	43.10
	360	128	1360	2530	850	1100	23240MBW33	23240KMBW33	53.40
	360	128	1360	2530	850	1100	23240CCW33	23240CCKW33	53.10
	280	60	495	1150	1600	2000	23940MBW33	23940KMBW33	13.20
	280	60	495	1150	1600	2000	23940CCW33	23940CCKW33	13.00
	420	165	2020	3500	750	950	23340MBW33	23340KMBW33	125.00
	340	140	1630	2450	900	1200	24140MBW33	24140KMBW33	53.50
	340	140	1630	2450	900	1200	24140CCW33	24140CCKW33	53.10
	310	109	985	2130	900	1200	24040MBW33	24040KMBW33	31.30
	310	109	985	2130	900	1200	24040CCW33	24040CCKW33	31.00
	360	98	1100	1950	1100	1500	22240MBW33	22240KMBW33	44.70
	360	98	1100	1950	1100	1500	22240CCW33	22240CCKW33	44.10
	420	138	1740	2860	850	1100	22340MBW33	22340KMBW33	97.00
	420	138	1740	2860	850	1100	22340CCW33	22340CCKW33	96.60
	220	340	90	935	1900	1100	1500	23044MBW33	23044KMBW33
340		90	935	1900	1100	1500	23044CCW33	23044CCKW33	31.70
370		120	1370	2710	900	1200	23144MBW33	23144KMBW33	54.70
370		120	1370	2710	900	1200	23144CCW33	23144CCKW33	54.40
400		144	1720	3200	750	950	23244MBW33	23244KMBW33	77.30
400		144	1720	3200	750	950	23244CCW33	23244CCKW33	77.00
300		60	500	980	1520	1760	23944MBW33	23944KMBW33	12.50
300		60	500	980	1520	1760	23944CCW33	23944CCKW33	12.10
370		150	1920	3045	800	1000	24144MBW33	24144KMBW33	67.00
370		150	1920	3045	800	1000	24144CCW33	24144CCKW33	66.60
340		118	1150	2500	850	1100	24044MBW33	24044KMBW33	39.10
340		118	1150	2500	850	1100	24044CCW33	24044CCKW33	38.70
400		108	1350	2400	950	1300	22244MBW33	22244KMBW33	63.50
400		108	1350	2400	950	1300	22244CCW33	22244CCKW33	63.10
460		145	2450	3130	800	1000	22344MBW33	22344KMBW33	115.00
460		145	2450	3130	800	1000	22344CCW33	22344CCKW33	115.00

Spherical Roller Bearing

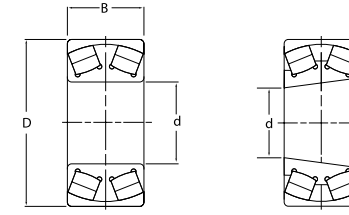

Cylindrical bore

Tapered bore (k)

d 240~260mm

Boundary dimensions (mm)			Basic load ratings(kN)		Speed ratings (rpm)		Bearing No.		Weight (kg)	
d	D	B	Dynamic C _r	Static C _{or}	Grease	Oil	Cylindrical bore	Tapered bore		
240	360	92	985	2080	1000	1400	23048MBW33	23048KMBW33	34.20	
	360	92	985	2080	1000	1400	23048CCW33	23048CCKW33	34.00	
	400	128	1500	3000	850	1100	23148MBW33	23148KMBW33	68.20	
	400	128	1500	3000	850	1100	23148CCW33	23148CCKW33	68.00	
	440	160	2080	3950	750	900	23248MBW33	23248KMBW33	102.00	
	440	160	2080	3950	750	900	23248CCW33	23248CCKW33	102.00	
	320	60	530	1310	1300	1700	23948MBW33	23948KMBW33	15.00	
	320	60	530	1310	1300	1700	23948CCW33	23948CCKW33	14.70	
	400	160	1660	3400	800	1000	24148MBW33	24148KMBW33	79.00	
	400	160	1660	3400	800	1000	24148CCW33	24148CCKW33	78.60	
	360	118	1240	2800	900	1200	24048MBW33	24048KMBW33	46.50	
	360	118	1240	2800	900	1200	24048CCW33	24048CCKW33	46.10	
	440	120	1640	1820	850	1150	22248MBW33	22248KMBW33	85.00	
	440	120	1640	1820	850	1150	22248CCW33	22248CCKW33	84.80	
	500	155	2480	3200	750	1000	22348MBW33	22348KMBW33	150.00	
	500	155	2480	3200	750	1000	22348CCW33	22348CCKW33	149.00	
	260	400	104	1230	2550	900	1200	23052MBW33	23052KMBW33	49.80
		400	104	1230	2550	900	1200	23052CCW33	23052CCKW33	49.10
440		144	1860	3750	800	1000	23152MBW33	23152KMBW33	88.90	
440		144	1860	3750	800	1000	23152CCW33	23152CCKW33	88.20	
480		174	2800	4750	630	800	23252MBW33	23252KMBW33	141.00	
480		174	2800	4750	630	800	23252CCW33	23252CCKW33	140.00	
360		75	820	1750	1100	1500	23952MBW33	23952KMBW33	21.60	
360		75	820	1750	1100	1500	23952CCW33	23952CCKW33	21.60	
440		180	2100	4350	650	850	24152MBW33	24152KMBW33	115.00	
440		180	2100	4350	650	850	24152CCW33	24152CCKW33	114.00	
400		140	1780	1910	750	1000	24052MBW33	24052KMBW33	66.70	
400		140	1780	1910	750	1000	24052CCW33	24052CCKW33	66.20	
360		100	970	2050	1000	1400	24952MBW33	24952KMBW33	31.30	
480		130	1900	3600	850	1100	22252MBW33	22252KMBW33	106.00	
480		130	1900	3600	850	1100	22252CCW33	22252CCKW33	105.00	
540		165	3000	4700	630	800	22352MBW33	22352KMBW33	184.00	
540		165	3000	4700	630	800	22352CCW33	22352CCKW33	183.00	

07 | Spherical Roller Bearing

Spherical Roller Bearing

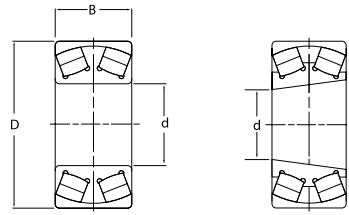

Cylindrical bore

Tapered bore (k)

d 280~300mm

Boundary dimensions (mm)			Basic load ratings(kN)		Speed ratings(rpm)		Bearing No.		Weight (kg)
d	D	B	Dynamic C _r	Static C _{or}	Grease	Oil	Cylindrical bore	Tapered bore	
280	420	106	1320	2850	850	1100	23056MBW33	23056KMBW33	56.80
	420	106	1320	2850	850	1100	23056CCW33	23056CCKW33	56.10
	460	146	1990	4150	750	950	23156MBW33	23156KMBW33	104.00
	460	146	1990	4150	750	950	23156CCW33	23156CCKW33	103.00
	500	176	2580	5100	600	750	23256MBW33	23256KMBW33	147.00
	500	176	2580	5100	600	750	23256CCW33	23256CCKW33	146.00
	380	75	700	1850	1000	1400	23956MBW33	23956KMBW33	25.80
	380	75	700	1850	1000	1400	23956CCW33	23956CCKW33	25.20
	460	180	2220	4750	600	800	24156MBW33	24156KMBW33	119.00
	460	180	2220	4750	600	800	24156CCW33	24156CCKW33	118.00
	420	140	1620	3700	670	850	24056MBW33	24056KMBW33	68.90
	420	140	1620	3700	670	850	24056CCW33	24056CCKW33	68.10
	500	130	1990	3600	800	1000	22256MBW33	22256KMBW33	118.00
	500	130	1990	3600	800	1000	22256CCW33	22256CCKW33	117.00
	580	175	3200	5700	600	750	22356MBW33	22356KMBW33	221.00
	580	175	3200	5700	600	750	22356CCW33	22356CCKW33	220.00
300	460	118	1610	3450	800	1000	23060MBW33	23060KMBW33	75.20
	460	118	1610	3450	800	1000	23060CCW33	23060CCKW33	75.00
	500	160	2310	4750	670	850	23160MBW33	23160KMBW33	126.00
	500	160	2310	4750	670	850	23160CCW33	23160CCKW33	125.00
	540	192	3300	5600	530	670	23260MBW33	23260KMBW33	192.00
	540	192	3300	5600	530	670	23260CCW33	23260CCKW33	191.00
	420	90	1050	2500	950	1300	23960MBW33	23960KMBW33	40.10
	420	90	1050	2500	950	1300	23960CCW33	23960CCKW33	39.70
	500	200	3400	5700	560	720	24160MBW33	24160KMBW33	160.00
	500	200	3400	5700	560	720	24160CCW33	24160CCKW33	159.00
	460	160	2020	2700	600	750	24060MBW33	24060KMBW33	99.00
	460	160	2020	2700	600	750	24060CCW33	24060CCKW33	98.20
	540	140	2310	4300	750	950	22260MBW33	22260KMBW33	138.00
	540	140	2310	4300	750	950	22260CCW33	22260CCKW33	137.00
	620	185	3500	5800	500	650	22360MBW33	22360KMBW33	270.00

Spherical Roller Bearing

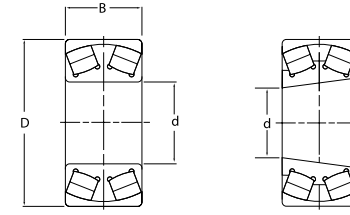

Cylindrical bore

Tapered bore (k)

d320~360mm

Boundary dimensions (mm)			Basic load ratings(kN)		Speed ratings (rpm)		Bearing No.		Weight (kg)	
d	D	B	Dynamic C _r	Static C _{or}	Grease	Oil	Cylindrical bore	Tapered bore		
320	480	121	1930	2200	800	1000	23064MBW33	23064KMBW33	85.50	
	480	121	1930	2200	800	1000	23064CCW33	23064CCKW33	85.00	
	540	176	3150	5800	630	800	23164MBW33	23164KMBW33	195.00	
	540	176	3150	5800	630	800	23164CCW33	23164CCKW33	194.00	
	580	208	3900	6800	500	630	23264MBW33	23264KMBW33	253.00	
	580	208	3900	6800	500	630	23264CCW33	23264CCKW33	252.00	
	440	90	1140	2660	900	1200	23964MBW33	23964KMBW33	43.00	
	440	90	1140	2660	900	1200	23964CCW33	23964CCKW33	42.50	
	540	218	3850	7300	500	700	24164MBW33	24164KMBW33	167.00	
	540	218	3850	7300	500	700	24164CCW33	24164CCKW33	166.00	
	480	160	2480	5100	560	700	24064MBW33	24064KMBW33	106.00	
	480	160	2480	5100	560	700	24064CCW33	24064CCKW33	105.00	
	580	150	2490	4550	670	850	22264MBW33	22264KMBW33	175.00	
	580	150	2490	4550	670	850	22264CCW33	22264CCKW33	174.00	
	670	200	3700	6000	450	600	22364MBW33	22364KMBW33	352.00	
	340	520	133	1980	4400	700	900	23068MBW33	23068KMBW33	115.00
520		133	1980	4400	700	900	23068CCW33	23068CCKW33	114.00	
580		190	3050	6300	600	750	23168MBW33	23168KMBW33	211.00	
580		190	3050	6300	600	750	23168CCW33	23168CCKW33	210.00	
620		224	4450	8000	380	570	23268MBW33	23268KMBW33	300.00	
460		90	1200	2700	900	1200	23968MBW33	23968KMBW33	45.60	
460		90	1200	2700	900	1200	23968CCW33	23968CCKW33	45.10	
580		243	4600	8250	400	600	24168MBW33	24168KMBW33	269.00	
580		243	4600	8250	400	600	24168CCW33	24168CCKW33	268.00	
520		180	2460	5700	530	670	24068MBW33	24068KMBW33	137.00	
520		180	2460	5700	530	670	24068CCW33	24068CCKW33	136.00	
620		165	2650	5050	550	700	22268MBW33	22268KMBW33	225.00	
710		212	3950	6500	400	550	22368MBW33	22368KMBW33	419.00	
360		540	134	2280	4800	670	850	23072MBW33	23072KMBW33	126.00
		540	134	2280	4800	670	850	23072CCW33	23072CCKW33	125.00
		600	192	3250	6850	560	700	23172MBW33	23172KMBW33	255.00
	600	192	3250	6850	560	700	23172CCW33	23172CCKW33	254.00	
	650	232	4650	8300	400	500	23272MBW33	23272KMBW33	330.00	
	480	90	1290	2820	850	1100	23972MBW33	23972KMBW33	46.60	
	480	90	1290	2820	850	1100	23972CCW33	23972CCKW33	46.10	
	600	243	5600	8400	400	500	24172MBW33	24172KMBW33	270.00	
	600	243	5600	8400	400	500	24172CCW33	24172CCKW33	269.00	
	540	180	3100	6600	630	800	24072MBW33	24072KMBW33	147.00	
	540	180	3100	6600	630	800	24072CCW33	24072CCKW33	146.00	
	750	224	4900	8600	350	450	22372MBW33	22372KMBW33	466.00	

07 | Spherical Roller Bearing

Spherical Roller Bearing

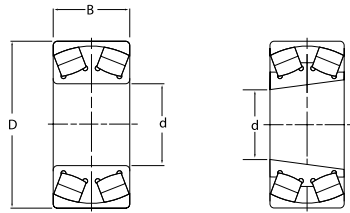

Cylindrical bore

Tapered bore (k)

d 380~440mm

Boundary dimensions (mm)			Basic load ratings(kN)		Speed ratings (rpm)		Bearing No.		Weight (kg)	
<i>d</i>	<i>D</i>	<i>B</i>	Dynamic C_r	Static C_{or}	Grease	Oil	Cylindrical bore	Tapered bore		
380	560	135	2480	5000	630	800	23076MBW33	23076KMBW33	130.00	
	560	135	2480	5000	630	800	23076CCW33	23076CCKW33	129.00	
	620	194	3400	7350	400	500	23176MBW33	23176KMBW33	244.00	
	620	194	3400	7350	400	500	23176CCW33	23176CCKW33	243.00	
	680	240	5200	9500	380	480	23276MBW33	23276KMBW33	380.00	
	520	106	1730	3800	800	1000	23976MBW33	23976KMBW33	69.50	
	520	106	1730	3800	800	1000	23976CCW33	23976CCKW33	69.10	
	620	243	5800	9650	400	500	24176MBW33	24176KMBW33	296.00	
	560	180	3150	6900	480	600	24076MBW33	24076KMBW33	153.00	
	560	180	3150	6900	480	600	24076CCW33	24076CCKW33	152.00	
	400	600	148	2540	5900	600	750	23080MBW33	23080KMBW33	161.00
		600	148	2540	5900	600	750	23080CCW33	23080CCKW33	160.00
650		200	4100	7650	380	480	23180MBW33	23180KMBW33	275.00	
720		256	6150	11300	340	430	23280MBW33	23280KMBW33	353.00	
540		106	2200	3900	750	950	23980MBW33	23980KMBW33	72.40	
540		106	2200	3900	750	950	23980CCW33	23980CCKW33	72.00	
650		250	5100	10300	380	480	24180MBW33	24180KMBW33	329.00	
600		200	3600	7800	450	560	24080MBW33	24080KMBW33	202.00	
600		200	3600	7800	450	560	24080CCW33	24080CCKW33	201.00	
720		185	4400	7400	420	550	22280MBW33	22280KMBW33	337.00	
820		243	6820	9500	350	450	22380MBW33	22380KMBW33	640.00	
420		620	150	2700	6400	450	560	23084MBW33	23084KMBW33	149.00
	620	150	2700	6400	450	560	23084CCW33	23084CCKW33	148.00	
	700	224	4250	9200	360	450	23184MBW33	23184KMBW33	353.00	
	700	224	4250	9200	360	450	23184CCW33	23184CCKW33	352.00	
	760	272	5610	11900	320	400	23284MBW33	23284KMBW33	550.00	
	560	106	2300	4250	600	800	23984MBW33	23984KMBW33	71.60	
	700	280	5600	11900	340	450	24184MBW33	24184KMBW33	421.00	
	620	200	3350	8450	380	480	24084MBW33	24084KMBW33	202.00	
440	650	157	2780	6500	430	530	23088MBW33	23088KMBW33	185.00	
	720	226	4500	10000	340	430	23188MBW33	23188KMBW33	378.00	
	790	280	6900	12800	300	400	23288MBW33	23288KMBW33	594.00	
	600	118	2450	4800	500	680	23988MBW33	23988KMBW33	96.30	
	720	280	6000	12000	320	430	24188MBW33	24188KMBW33	433.00	
	650	212	4150	9100	330	420	24088MBW33	24088KMBW33	237.00	

Spherical Roller Bearing

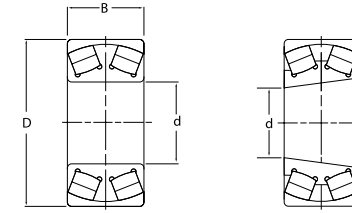

Cylindrical bore

Tapered bore (k)

d 460~480mm

Boundary dimensions (mm)			Basic load ratings(kN)		Speed ratings (rpm)		Bearing No.		Weight (kg)
<i>d</i>	<i>D</i>	<i>B</i>	Dynamic C_r	Static C_{or}	Grease	Oil	Cylindrical bore	Tapered bore	
460	680	163	3450	6950	400	500	23092MBW33	23092KMBW33	226.00
	760	240	5500	10000	320	400	23192MBW33	23192KMBW33	457.00
	830	296	7350	13500	300	380	23292MBW33	23292KMBW33	698.00
	620	118	2550	4950	430	530	23992MBW33	23992KMBW33	100.00
	760	300	6100	14400	300	400	24192MBW33	24192KMBW33	558.00
	680	218	4200	9200	320	400	24092MBW33	24092KMBW33	277.00
480	700	165	3800	7950	400	480	23096MBW33	23096KMBW33	218.00
	790	248	6100	12000	300	380	23196MBW33	23196KMBW33	516.00
	870	310	6750	15200	260	340	23296MBW33	23296KMBW33	853.00
	650	128	2150	5750	400	500	23996MBW33	23996KMBW33	125.00
	790	308	7150	14600	300	380	24196MBW33	24196KMBW33	616.00
	700	218	4600	10200	320	400	24096MBW33	24096KMBW33	288.00

08 | Thrust Ball & Roller Bearing

Thrust ball bearings are divided into two types:

1. Single Direction Thrust Bearings

These can accommodate axial load in one direction.

2. Double Direction Thrust Bearings

These can accommodate axial load in both directions.

Thrust bearings are not suitable for applications which require high speed or radial load.

The standard cages used are pressed steel cages or with copper alloy machined cage and in some cases also have molded cages.

For details on boundary dimensions and specifications please refer to the tables overleaf.

Thrust Ball & Roller Bearing



08 | Thrust Ball & Roller Bearing

Single Direction Thrust Ball Bearings

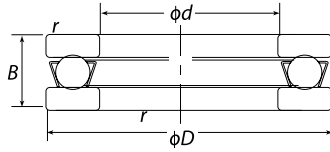

Boundary dimensions (mm)				Basic load ratings(kN)		Speed ratings (rpm)		GOCT	Bearing No.	Weight (kg)
<i>d</i>	<i>D</i>	<i>T</i>	<i>r</i>	Dynamic (C)	Static (Co)	Grease	Oil			
10	24	9	0.3	10.00	14.00	10000	6500	8100	51100	0.020
12	26	9	0.3	10.30	15.40	10000	6500	8101	51101	0.022
15	28	9	0.3	10.50	16.80	9400	6100	8102	51102	0.024
17	30	9	0.3	10.80	18.20	9400	6100	8103	51103	0.028
20	35	10	0.3	14.20	24.70	7900	5100	8104	51104	0.040
25	42	11	0.6	19.50	37.20	6800	4400	8105	51105	0.059
30	47	11	0.6	20.40	42.20	6600	4300	8106	51106	0.068
35	52	12	0.6	20.40	44.70	6000	3900	8107	51107	0.090
40	60	13	0.6	26.90	62.80	5000	3400	8108	51108	0.120
45	65	14	0.6	27.80	69.10	5000	3200	8109	51109	0.150
50	70	14	0.6	28.80	75.4	4800	3100	8110	51110	0.160
55	78	16	0.6	34.80	93.10	4300	2800	8111	51111	0.240
60	85	17	1.0	41.40	113.00	4000	2600	8112	51112	0.290
65	90	18	1.0	41.70	117.00	3700	2400	8113	51113	0.340
70	95	18	1.0	43.00	125.00	3600	2300	8114	51114	0.360
75	100	19	1.0	43.20	127.00	3400	2200	8115	51115	0.420
80	105	19	1.0	44.60	141.00	3300	2100	8116	51116	0.430
85	110	19	1.0	59.70	150.00	3200	2100	8117	51117	0.460
90	120	22	1.0	59.70	190.00	2900	1900	8118	51118	0.680
100	135	25	1	85	268	2500	1600	8120	51120	0.990

Single Direction Thrust Ball Bearings

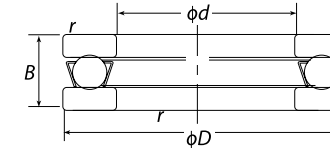

Boundary dimensions (mm)				Basic load ratings(kN)		Speed ratings (rpm)		GOCT	Bearing No.	Weight (kg)
<i>d</i>	<i>D</i>	<i>T</i>	<i>r</i>	Dynamic (C)	Static (Co)	Grease	Oil			
10	26	11	0.6	12.70	17.10	8800	5700	8200	51200	0.030
12	28	11	0.6	13.20	19.00	8300	5400	8201	51201	0.034
15	32	12	0.6	16.60	24.80	7500	4900	8202	51202	0.046
17	35	12	0.6	17.20	27.30	7500	4900	8203	51203	0.053
20	40	14	0.6	22.30	37.70	6000	3900	8204	51204	0.082
25	47	15	0.6	27.80	50.40	5500	3600	8205	51205	0.120
30	52	16	0.6	29.30	58.20	5200	3400	8206	51206	0.150
35	62	18	1.0	39.20	78.20	4500	2900	8207	51207	0.220
40	68	19	1.0	46.90	98.30	4200	2700	8208	51208	0.270
45	73	20	1.0	47.70	105.00	4000	2600	8209	51209	0.320
50	78	22	1.0	48.50	111.00	3600	2300	8210	51210	0.390
55	90	25	1.0	69.40	159.00	3200	2100	8211	51211	0.610
60	95	26	1.0	73.60	179.00	3000	1900	8212	51212	0.690
65	100	27	1.0	74.80	189.00	2900	1900	8213	51213	0.770
70	105	27	1.0	73.60	189.00	2800	1800	8214	51214	0.810
75	110	27	1.0	77.40	209.00	2700	1800	8215	51215	0.860
80	115	28	1.0	78.50	218.00	2600	1700	8216	51216	0.950
85	125	31	1.0	92.30	251.00	2300	1500	8217	51217	1.290
90	135	35	1.1	117.00	326.00	2100	1400	8218	51218	1.770
100	150	38	1.1	147	410	1900	1200	8220	51220	2.360

08 | Thrust Ball & Roller Bearing

Single Direction Thrust Ball Bearings

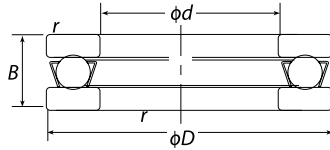

Boundary dimensions (mm)				Basic load ratings(kN)		Speed ratings (rpm)		ГОСТ	Bearing No.	Weight (kg)
d	D	T	B	Dynamic (C)	Static (Co)	Grease	Oil			
25	52	18	1	35.7	61.4	4800	3100	8305	51305	0.18
30	60	21	1	42.8	78.7	4200	2700	8306	51306	0.27
35	68	24	1	55.5	105	3700	2400	8307	51307	0.39
40	78	26	1	69.3	135	3300	2100	8308	51308	0.55
45	85	28	1	80	163	3000	1900	8309	51309	0.69
50	95	31	1.1	91.6	186	2700	1800	8310	51310	1.00
55	105	35	1.1	119	246	2400	1600	8311	51311	1.34
60	110	35	1.1	124	267	2300	1500	8312	51312	1.43
65	115	36	1.1	128	287	2200	1400	8313	51313	1.57
70	125	40	1.1	148	339	2000	1300	8314	51314	2.06
75	135	44	1.5	171	396	1900	1200	8315	51315	2.68
80	140	44	1.5	176	424	1800	1200	8316	51316	2.82
85	150	49	1.5	206	489	1700	1100	8317	51317	3.66
90	155	50	1.5	213	524	1600	1000	8318	51318	3.88
100	170	55	1.5	236	596	1450	940	8320	51320	5.11

Thrust Ball Bearing Single Direction Series

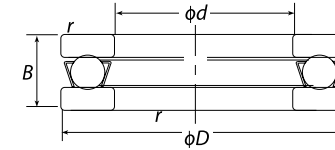

Boundary dimensions (mm)			Basic load ratings(kN)		Speed ratings(rpm)	ГОСТ	Bearing No.	Weight (kg)
d	D	B	Dynamic (C)	Static (Co)	Grease			
25	60	24	40000	67000	3000	8405	51405	0.34
30	70	28	54000	93000	2500	8406	51406	0.53
35	80	32	65000	117000	2200	8407	51407	0.79
40	90	36	84000	153000	2000	8408	51408	1.15
45	100	39	97000	180000	1800	8409	51409	1.45
50	110	43	119000	230000	1700	8410	51410	2.00
55	120	48	130000	270000	1500	8411	51411	2.65
60	130	51	149000	300000	1350	8412	51412	3.30
65	140	56	162000	335000	1250	8413	51413	4.20
70	150	60	175000	375000	1200	8414	51414	5.10
75	160	65	188000	420000	1100	8415	51415	6.35
80	170	68	200000	465000	1000	8416	51416	8.00
85	180	72	214000	510000	1000	8417	51417	9.45
90	190	77	230000	560000	900	8418	51418	11.00
100	210	85	278000	720000	800	8420	51420	14.70

08 | Thrust Ball & Roller Bearing

Double Direction Thrust Ball Bearings

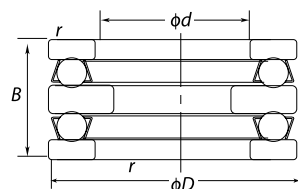

Boundary dimensions (mm)			Basic load ratings(kN)		Speed ratings (rpm)	ГОСТ	Bearing No.	Weight (kg)
d	D	B	Dynamic (C)	Static (Co)	Grease			
10	32	22	1200	18500	5000	38202	52202	0.09
15	40	26	1600	28000	4500	38204	52204	0.15
20	47	28	20000	37000	4000	38205	52205	0.23
25	52	29	19000	35000	3600	38206	52206	0.28
30	62	34	26000	50000	3200	38207	52207	0.42
30	68	36	35000	73000	2800	38208	52208	0.54
35	73	37	27000	60000	2700	38209	52209	0.62
40	78	39	38000	80000	2500	38210	52210	0.71
45	90	45	46000	100000	2100	38211	52211	1.10
50	95	46	47000	105000	2100	38212	52212	1.25
55	100	47	48000	112000	1900	38213	52213	1.35
60	110	47	50000	120000	1800	38215	52215	1.65
65	115	48	57000	140000	1800	38216	52216	1.7
70	125	55	73000	185000	1600	38217	52217	2.35
75	135	62	89000	225000	1500	38218	52218	3.2
85	150	67	93000	240000	1300	38220	52220	4.3
95	160	67	97000	270000	1300	38222	52222	4.7
100	170	68	105000	300000	1200	38224	52224	5.25

Double Direction Thrust Ball Bearings

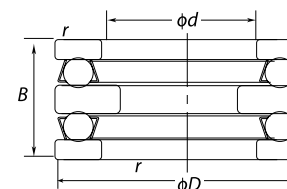

Boundary dimensions (mm)			Basic load ratings(kN)		Speed ratings (rpm)	ГОСТ	Bearing No.	Weight (kg)
d	D	B	Dynamic (C)	Static (Co)	Grease			
20	52	34	25000	41000	3800	38305	52305	0.33
25	60	38	28000	49000	3200	38306	52306	0.49
30	68	44	37000	66000	2900	38307	52307	0.71
30	78	49	46000	84000	2500	38308	52308	1.05
35	85	52	57000	105000	2400	38309	52309	1.30
40	95	58	66000	130000	2200	38310	52310	1.85
45	105	64	78000	155000	1800	38311	52311	2.50
50	110	64	75000	155000	1800	38312	52312	2.70
55	115	65	80000	165000	1700	38313	52313	2.90
55	125	72	100000	225000	1600	38314	52314	3.90
60	135	79	120000	270000	1400	38315	52315	4.85
65	140	79	119000	270000	1400	38316	52316	5.05
70	150	87	130000	310000	1300	38317	52317	6.45
75	155	88	150000	350000	1250	38318	52318	6.60
85	170	97	170000	420000	1200	38320	52320	8.90
95	190	110	200000	550000	1000	38322	52322	13.10
100	210	123	240000	680000	950	38324	52324	18.40

08 | Thrust Ball & Roller Bearing

Double Direction Thrust Ball Bearings

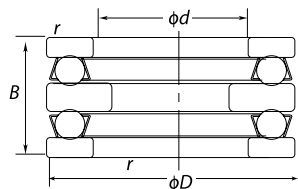

Boundary dimensions (mm)			Basic load ratings (kN)		Speed ratings (rpm)	ГОСТ	Bearing No.	Weight (kg)
d	D	B	Dynamic (C)	Static (Co)	Grease			
15	60	45	40000	70000	2600	38405	52405	0.630
20	70	52	54000	93000	2500	38406	52406	1.000
25	80	59	65000	115000	2200	38407	52407	1.440
30	90	65	84000	153000	2000	38408	52408	2.030
35	100	72	97000	180000	1800	38409	52409	2.710
40	110	78	110000	210000	1700	38410	52410	3.566
45	120	87	130000	270000	1500	38411	52411	4.700
50	30	93	149000	300000	1300	38412	52412	6.330
50	140	101	173000	370000	1200	38413	52413	8.030
55	150	107	185000	410000	1100	38414	52414	9.710
60	160	115	190000	420000	1050	38415	52415	11.800
65	170	120	200000	465000	950	38416	52416	14.800
65	180	128	215000	513000	900	38417	52417	18.600
70	190	135	230000	560000	800	38418	52418	20.800
80	210	150	258000	670000	750	38420	52420	28.200
90	230	166	325000	930000	720	38422	52422	37.800
95	250	177	340000	1000000	650	38424	52424	48.400
100	270	192	410000	1300000	600	38426	52426	60.100

Double Direction Thrust Ball Bearings

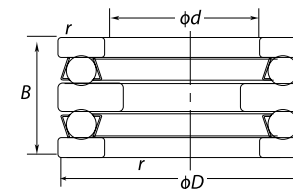

Boundary dimensions (mm)			Basic load ratings (kN)		Speed ratings (rpm)	ГОСТ	Bearing No.	Weight (kg)
d	D	B	Dynamic (C)	Static (Co)	Grease			
15	32	13.3	12000	18000	6000	18202	53202	0.046
17	35	13.2	13000	20000	5700	18203	53203	0.054
20	40	14.7	16000	27000	5100	18204	53204	0.081
25	47	16.7	20000	37000	4500	18205	53205	0.111
30	52	17.8	19000	35000	4100	18206	53206	0.139
35	62	19.9	26000	50000	3400	18207	53207	0.215
40	68	20.3	35000	73000	3200	18208	53208	0.276
45	73	21.3	29000	60000	3000	18209	53209	0.317
50	78	23.5	37000	80000	2900	18210	53210	0.378
55	90	27.3	46000	100000	2400	18211	53211	0.608
60	95	28.0	47000	105000	2400	18212	53212	0.678
65	100	28.7	48000	1100000	2200	18213	53213	0.767
70	105	28.8	49000	120000	2200	18214	53214	0.793
75	110	28.3	50000	127000	2000	18215	53215	0.874
80	115	29.5	57000	140000	2000	18216	53216	0.916
85	125	33.1	73000	185000	1800	18217	53217	1.250
90	135	38.5	89000	225000	1700	18218	53218	1.700
100	150	40.9	93000	240000	1500	18220	53220	2.290

08 | Thrust Ball & Roller Bearing

Single Direction Thrust Ball Bearings With Sphered Housing Washer

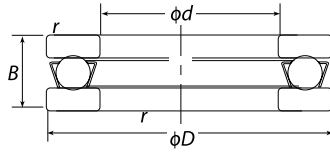

Boundary dimensions (mm)			Basic load ratings(kN)		Speed ratings (rpm)	ГОСТ	Bearing No.	Weight (kg)
d	D	B	Dynamic (C)	Static (Co)	Grease			
25	52	19.8	17000	30000	3400	18305	53305	0.176
30	60	22.6	27500	48700	3200	18306	53306	0.269
35	68	25.6	37000	66000	2900	18307	53307	0.383
40	78	28.5	46000	84000	2500	18308	53308	0.548
45	85	30.1	57000	105000	2400	18309	53309	0.684
50	95	34.4	66000	125000	2200	18310	53310	0.951
55	105	39.3	78000	156000	1800	18311	53311	1.290
60	110	38.3	75000	156000	1800	18312	53312	1.370
65	115	39.4	79000	165000	1700	18313	53313	1.510
70	125	44.2	100000	225000	1600	18314	53314	2.010
75	135	48.1	120000	270000	1400	18315	53315	2.610
80	140	47.6	119000	270000	1400	18316	53316	2.720
85	150	53.1	140000	318000	1300	18317	53317	3.520
90	155	54.6	146000	348000	1200	18318	53318	3.740
100	170	69.2	170000	420000	1200	18320	53320	4.880

Single Direction Thrust Ball Bearings With Sphered Housing Washer

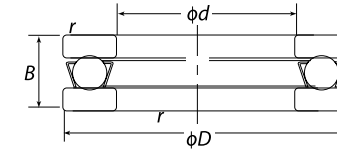

Boundary dimensions (mm)			Basic load ratings(kN)		Speed ratings (rpm)	ГОСТ	Bearing No.	Weight (kg)
d	D	B	Dynamic (C)	Static (Co)	Grease			
40	90	38.2	84000	153000	1800	18408	53408	1.08
45	100	42.4	97000	180000	1700	18409	53409	1.43
50	110	45.6	119000	232000	1700	18410	53410	1.90
55	120	50.5	130000	250000	1500	18411	53411	2.52
60	130	54.0	150000	300000	1300	18412	53412	3.12
65	140	60.2	160000	330000	1200	18413	53413	3.96
70	150	63.6	175000	375000	1200	18414	53414	5.50
75	160	69.0	188000	420000	1100	18415	53415	6.85
80	170	72.2	200000	465000	1000	18416	53416	8.00
85	180	77.0	215000	510000	950	18417	53417	9.03
90	190	81.2	230000	560000	900	18418	53418	11.00
100	210	90.0	278000	720000	800	18420	53420	15.00

08 | Thrust Ball & Roller Bearing

Spherical Thrust Roller Bearing



Boundary dimensions (mm)			Basic load ratings (kN)		Speed ratings (rpm)	GOCT	Bearing No.	Weight (kg)
<i>d</i>	<i>D</i>	<i>B</i>	Dynamic (C)	Static (Co)	Grease			
150	215	39	272000	1070000	1500	9039230	29230	4.56
160	225	39	280000	1170000	1450	9039232	29232	4.88
170	240	42	300000	1250000	1400	9039234	29234	6.02
180	250	42	315000	1320000	1350	9039236	29236	6.25
190	270	48	390000	1650000	1200	9039238	29238	8.70
200	280	48	400000	1710000	1200	9039240	29240	8.96
220	300	48	410000	1800000	1100	9039244	29244	9.03
240	340	60	600000	2580000	900	9039248	29248	16.50
260	360	60.0	610000	2700000	900	9039252	29252	18.00
280	380	60	640000	3000000	850	9039256	29256	19.00
300	420	73	800000	3600000	750	9039260	29260	30.00
320	440	73	830000	3825000	700	9039264	29264	32.50
340	460	73	845000	4000000	700	9039268	29268	33.50
360	500	85	1100000	5100000	600	9039272	29272	51.00
380	520	85	1185000	5735000	600	9039276	29276	52.00
400	540	82	1205000	6000000	600	9039280	29280	55.00
420	580	95	1490000	7350000	530	9039284	29284	72.00
440	600	95	1550000	7800000	530	9039288	29288	77.00
460	620	95	1550000	7950000	500	9039292	29292	80.00
480	650	103	1760000	8850000	470	9039296	29296	97.00
500	670	103	1790000	9375000	470	90392/500	292/500	100.00

Spherical Thrust Roller Bearing



Boundary dimensions (mm)				Basic load ratings(kN)		Speed ratings(rpm)	GOCT	Bearing No.	Weight (kg)
<i>d</i>	<i>D</i>	<i>B</i>	<i>r</i>	Dynamic (C)	Static (Co)	Grease			
85	150	39	1.5	287	927	2600	9039317	29317	5.91
90	150	39	1.5	299	966	2500	9039318	29318	3.06
100	150	39	1.5	355	1160	2300	9039320	29320	3.81
110	150	39	1.5	457	1530	2000	9039322	29322	5.56
120	150	39	1.5	553	1880	1800	9039324	29324	7.63
130	150	39	1.5	643	2220	1700	9039326	29326	9.43
140	240	60	2.1	707	2490	1600	9039328	29328	11.10
150	250	60	2.1	711	2500	1550	9039330	29330	11.60
160	270	67	3	862	3070	1400	9039332	29332	15.40
170	280	67	3	880	3170	1350	9039334	29334	16.20
180	300	73	3	1030	3730	1250	9039336	29336	20.70
190	320	78	4	1170	4230	1150	9039338	29338	25.10
200	340	85	4	1360	5040	1050	9039340	29340	31.20
220	360	85	4	1380	5240	1000	9039344	29344	33.30
240	380	85	4	1410	5500	950	9039348	29348	35.50
260	420	95	5	1810	6950	850	9039352	29352	49.10
280	440	95	5.0	1840	7150	800	9039356	29356	53.20

DPI provide various bearing designations both in metric and inch series, including bearings with solid rings bearings with pressed steel outer ring, radial needle roller bearings and cage assembly. These bearings are used in any applications, like automobile, motorcycle, electric tools, agriculture machines, textile machines, engineering machines, printing machines and automation instruments.

Needle Roller Bearings



Needle Roller Bearings

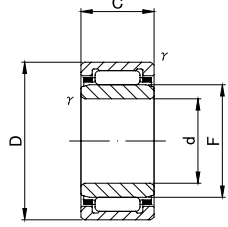

NKI(d ≤ 8)

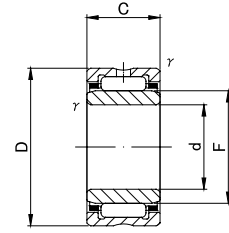

NA49,NA59,NA69(d ≤ 30),NKI

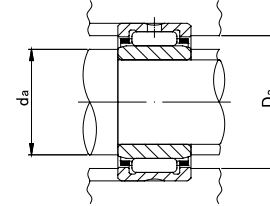

Shaft Diameter (mm)	Bearing No.					Dimensions (mm)					Standard mounting dimensions (mm)			Basic dynamic load rating	Basic Static load rating	Limiting speed	Weight
	NA 49	NA 59	NA 69	NA 48	NKI	d	D	C	rs min	F	da Min	da Max	Da Max	Cr N	Cor N	* rpm	g (approx)
5	NA495	-	-	-	-	5	13	10	0.15	7	6.2	6.7	11.8	2 960	2 690	34000	7.30
	-	-	-	-	NKI 5/12	5	15	12	0.3	8	7	7.7	13	5 100	4 700	32000	11.9
	-	-	-	-	NKI 5/16	5	15	16	0.3	8	7	7.7	13	7 300	7 300	32000	16.7
6	NA 496	-	-	-	-	6	15	10	0.15	8	7.2	7.7	13.8	3 900	3 400	32 000	9.10
	-	-	-	-	NKI 6/12	6	16	12	0.3	9	8	8.7	14	5 500	5 300	30 000	13.0
	-	-	-	-	NKI 6/16	6	16	16	0.3	9	8	8.7	14	7 600	8 200	30 000	17.5
7	NA 497	-	-	-	-	7	17	10	0.15	9	8.2	8.7	15.8	4 500	3 600	30 000	11.2
	-	-	-	-	NKI 7/12	7	17	12	0.3	10	9	9.7	15	5 900	6 000	28 000	14.3
	-	-	-	-	NKI 7/16	7	17	16	0.3	10	9	9.7	15	8 200	9 200	28 000	19.2
8	NA 498	-	-	-	-	8	19	11	0.2	10	9.2	9.7	17.4	6 200	5 000	28 000	15.0
9	-	-	-	-	NKI 9/12	9	19	12	0.3	12	11	11.5	17	6 600	7 300	26 000	16.7
	NA 499	-	-	-	NKI 9/16	9	19	16	0.3	12	11	11.5	17	9 200	11 200	26 000	22.5
	-	-	-	-	-	9	20	11	0.3	12	11	11.5	18	6 600	6 300	26 000	16.7
10	NA 4900	-	-	-	-	10	22	13	0.3	14	12	13	20	9 200	10 100	24 000	24.0
	-	-	-	-	NKI 10/16	10	22	16	0.3	14	12	13	20	11 800	13 700	24 000	30.0
	-	-	-	-	NKI 10/20	10	22	20	0.3	14	12	13	20	14 800	18 500	24 000	38.0
12	NA 4901	-	-	-	-	12	24	13	0.3	16	14	15	22	9 700	11 100	23 000	26.5
	-	-	-	-	NKI 12/16	12	24	16	0.3	16	14	15	22	12 300	15 100	23 000	33.5
	-	-	-	-	NKI 12/20	12	24	20	0.3	16	14	15	22	15 600	20 400	23 000	42.5
	-	-	NA 6901	-	-	12	24	22	0.3	16	14	15	22	17 100	23 000	23 000	44.5

* Suitable for oil lubrication. In case of grease lubrication, down to 60% of this value

Needle Roller Bearings

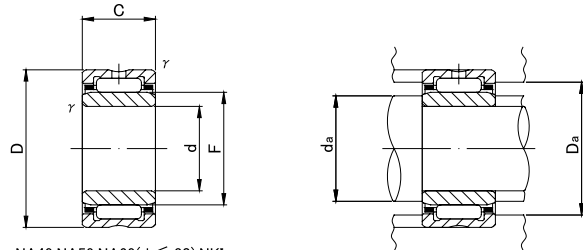

NA49,NA59,NA69(d ≤ 30),NKI

Shaft Diameter (mm)	Bearing No.					Dimensions (mm)					Standard mounting dimensions (mm)			Basic dynamic load rating	Basic Static load rating	Limiting speed	Weight g (approx)
	NA 49	NA 59	NA 69	NA 48	NKI	d	D	C	rs min	F	da		Cr	Cor	rpm		
											Min	Max	Max	N			N
15	-	-	-	-	NKI 15/16	15	27	16	0.3	19							
	-	-	-	-	NKI 15/20	15	27	20	0.3	19							
	NA 4902	-	-	-	-	15	0	28	13	0.3	20						
	-	NA 5902	-	-	-	15	-0.008	28	18	0.3	20						
	-	-	NA 6902	-	-	15		28	23	0.3	20						
17	-	-	-	-	NKI 17/16	17	29	16	0.3	21							
	-	-	-	-	NKI 17/20	17	29	20	0.3	21							
	NA 4903	-	-	-	-	17	0	30	13	0.3	22						
	-	NA 5903	-	-	-	17	-0.008	30	18	0.3	22						
	-	-	NA 6903	-	-	17		30	23	0.3	22						
20	-	-	-	-	NKI 20/16	20	32	16	0.3	24							
	-	-	-	-	NKI 20/20	20	32	20	0.3	24							
	NA 4904	-	-	-	-	20	0	37	17	0.3	25						
	-	NA 5904	-	-	-	20	-0.010	37	23	0.3	25						
	-	-	NA 6904	-	-	20		37	30	0.3	25						
22	-	-	-	-	NKI 22/16	22	34	16	0.3	26							
	-	-	-	-	NKI 22/20	22	34	20	0.3	26							
	NA 49/22	-	-	-	-	22	0	39	17	0.3	28						
	-	NA 59/22	-	-	-	22	-0.010	39	23	0.3	28						
	-	-	NA 69/22	-	-	22		39	30	0.3	28						
25	-	-	-	-	NKI 25/20	25	38	20	0.3	29							
	-	-	-	-	NKI 25/30	25	38	30	0.3	29							
	NA 4905	-	-	-	-	25	0	42	17	0.3	30						
	-	NA 5905	-	-	-	25	-0.010	42	23	0.3	30						
	-	-	NA 6905	-	-	25		42	30	0.3	30						
28	-	-	-	-	NKI 28/20	28	42	20	0.3	32							
	-	-	-	-	NKI 28/30	28	42	30	0.3	32							
	NA 49/28	-	-	-	-	28	0	45	17	0.3	32						
	-	NA 59/28	-	-	-	28	-0.010	45	23	0.3	32						
	-	-	NA 69/28	-	-	28		45	30	0.3	32						
30	-	-	-	-	NKI 30/20	30	45	20	0.3	35							
	-	-	-	-	NKI 30/30	30	45	30	0.3	35							
	NA 4906	-	-	-	-	30	0	47	17	0.3	35						
	-	NA 5906	-	-	-	30	-0.010	47	23	0.3	35						
	-	-	NA 6906	-	-	30		47	30	0.3	35						

* Suitable for oil lubrication. In case of grease lubrication, down to 60% of this value

09 | Needle Roller Bearing

Needle Roller Bearings

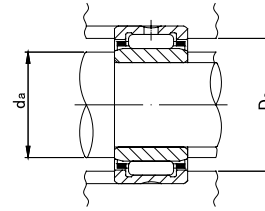
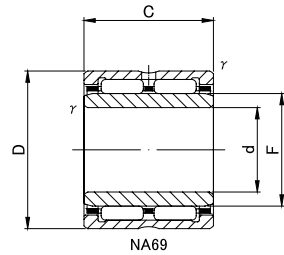
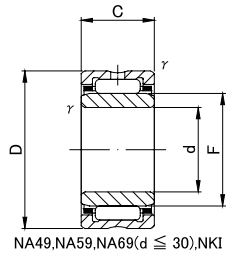

Shaft Diameter (mm)	Bearing No.					Dimensions (mm)					Standard mounting dimensions (mm)			Basic dynamic load rating	Basic Static load rating	Limiting speed	Weight g (approx)		
	NA 49	NA 59	NA 69	NA 48	NKI	d	D	C	r _s min	F	da		Cr	Cor	* rpm				
											Min	Max	Max	N			N		
32	-	-	-	-	NKI 32/20	32	47	20	0.3	37			45	28 200	50 100	11 000	121		
	-	-	-	-	NKI 32/30	32	47	30	0.3	37			45	40 500	79 800	11 000	180		
	NA 49/32	-	-	-	-	32	0	52	20	0.6	40			48	47 900	10 000	165		
	-	NA 59/32	-	-	-	32	-0.012	52	27	0.6	40			48	41 900	69 900	10 000	241	
	-	-	NA 69/32	-	-	-	32		52	36	0.6	40			48	53 500	95 700	10 000	295
35	-	-	-	-	NKI 35/20	35	50	20	0.3	40			48	29 400	54 100	10 000	129		
	-	-	-	-	NKI 35/30	35	50	30	0.3	40			48	42 300	86 100	10 000	192		
	NA 4907	-	-	-	-	35	0	55	20	0.6	42			51	32 000	50 200	9 500	178	
	-	NA 5907	-	-	-	35	-0.012	55	27	0.6	42			51	42 900	73 200	9 500	256	
	-	-	NA 6907	-	-	-	35		55	36	0.6	42			51	54 800	100 000	9 500	320
38	-	-	-	-	NKI 38/20	38	0	53	20	0.3	43			51	30 500	58 100	9 500	136	
	-	-	-	-	NKI 38/30	38	-0.012	53	30	0.3	43			51	43 700	92 500	9 500	205	
40	-	-	-	-	NKI 40/20	40		55	20	0.3	45			53	31 100	60 100	9 000	143	
	-	-	-	-	NKI 40/30	40		55	30	0.3	45			53	44 500	95 700	9 000	215	
	NA 4908	-	-	-	-	40	0	62	22	0.6	48			58	41 600	67 400	8 500	245	
	-	NA 5908	-	-	-	40	-0.012	62	30	0.6	48			58	58 000	103 000	8 500	348	
	-	-	NA 6908	-	-	-	40		62	40	0.6	48			58	71 300	134 400	8 500	440
42	-	-	-	-	NKI 42/20	42	0	57	20	0.3	47			55	31 500	62 300	8 500	149	
	-	-	-	-	NKI 42/30	42	-0.012	57	30	0.3	47			55	45 200	99 000	8 500	225	
45	-	-	-	-	NKI 45/25	45		62	25	0.6	50			58	43 000	85 200	8 000	230	
	-	-	-	-	NKI 45/35	45		62	35	0.6	50			58	58 100	125 500	8 000	320	
	NA 4909	-	-	-	-	45	0	68	22	0.6	52			64	43 500	73 400	7 500	285	
	-	NA 5909	-	-	-	45	-0.012	68	30	0.6	52			64	60 700	112 000	7 500	396	
	-	-	NA 6909	-	-	-	45		68	40	0.6	52			64	74 600	147 100	7 500	520
50	-	-	-	-	NKI 50/25	50		68	25	0.6	55			64	45 400	94 100	7 500	270	
	-	-	-	-	NKI 50/35	50		68	35	0.6	55			64	61 300	138 300	7 500	365	
	NA 4910	-	-	-	-	50	0	72	22	0.6	58			68	46 200	82 100	7 000	295	
	-	NA 5910	-	-	-	50	-0.012	72	30	0.6	58			68	64 400	126 000	7 000	498	
	-	-	NA 6910	-	-	-	50		72	40	0.6	58			68	79 100	163 800	7 000	530
	-	-	-	-	-	-	50		72	40	0.6	58			68				

* Suitable for oil lubrication. In case of grease lubrication, down to 60% of this value

Needle Roller Bearings

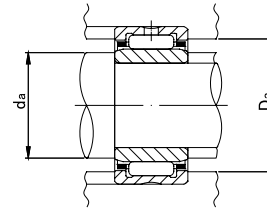
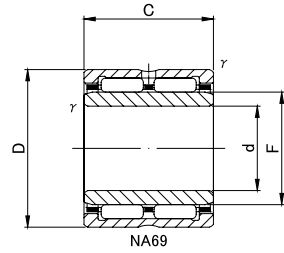
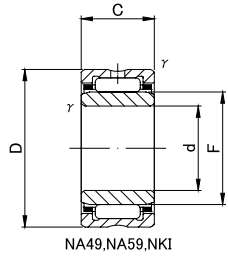

Shaft Diameter (mm)	Bearing No.					Dimensions (mm)					Standard mounting dimensions (mm)			Basic dynamic load rating	Basic Static load rating	Limiting speed	Weight g (approx)
	NA 49	NA 59	NA 69	NA 48	NKI	d	D	C	r _s min	F	da		Cr	Cor	* rpm		
											Min	Max	Max	N			N
55	-	-	-	-	NKI 55/25	55	72	25	0.6	60				47 500	103 000	6 500	275
	-	-	-	-	NKI 55/35	55	72	35	0.6	60				64 100	151 000	6 500	380
	NA 4911	-	-	-	-	55	80	25	1	63				57 600	97 300	6 500	410
	-	NA 5911	-	-	-	55	80	34	1	63	-0.015			82 600	154 000	6 500	559
	-	-	NA 6911	-	-	-	55	80	45	1	63			99 000	194 200	6 500	730
60	-	-	-	-	NKI 60/25	60	82	25	0.6	68				54 800	116 700	6 000	395
	-	-	-	-	NKI 60/35	60	82	35	0.6	68				72 100	165 700	6 000	560
	NA 4912	-	-	-	-	60	85	25	1	68				60 100	104 900	6 000	440
	-	NA 5912	-	-	-	60	85	34	1	68	-0.015			86 100	167 000	6 000	614
	-	-	NA 6912	-	-	-	60	85	45	1	68			103 000	210 800	6 000	785
65	NA 4913	-	-	-	-	65	90	25	1	72				62 800	113 800	5 500	470
	-	NA 5913	-	-	-	65	90	34	1	72				89 900	180 000	5 500	655
	-	-	-	-	NKI 65/35	65	90	35	0.6	73	-0.015			80 400	180 400	5 500	710
	-	-	NA 6913	-	-	65	90	45	1	72				107 900	226 500	5 500	840
70	-	-	-	-	NKI 70/25	70	95	25	1	80				59 400	137 300	5 000	540
	-	-	-	-	NKI 70/35	70	95	35	1	80				78 100	194 200	5 000	755
	NA 4914	-	-	-	-	70	100	30	1	80				83 200	157 900	5 000	765
	-	NA 5914	-	-	-	70	100	40	1	80	-0.015			112 000	232 000	5 000	1 060
	-	-	NA 6914	-	-	70	100	54	1	80				133 400	310 900	5 000	1 400
75	-	-	-	-	NKI 75/25	75	105	25	1	85				76 400	145 100	4 500	675
	NA 4915	-	-	-	-	75	105	30	1	85				86 200	169 700	4 500	810
	-	-	-	-	NKI 75/35	75	105	35	1	85				102 000	209 900	4 500	945
	-	NA 5915	-	-	-	75	105	40	1	85	-0.015			116 000	249 000	4 500	1 130
	-	-	NA 6915	-	-	75	105	54	1	85				138 300	330 500	4 500	1 480
80	-	-	-	-	NKI 80/25	80	110	25	1	90				77 400	150 000	4 500	710
	NA 4916	-	-	-	-	80	110	30	1	90				87 400	174 600	4 500	855
	-	-	-	-	NKI 80/35	80	110	35	1	90				103 000	216 700	4 500	995
	-	NA 5916	-	-	-	80	110	40	1	90	-0.015			117 000	257 000	4 500	1 150
	-	-	NA 6916	-	-	80	110	54	1	90				143 200	350 100	4 500	1 560
85	-	-	-	-	NKI 85/26	85	115	26	1	95				79 700	158 900	4 200	775
	-	-	-	-	NKI 85/36	85	115	36	1	95				106 900	230 500	4 200	1 080
	NA 4917	-	-	-	-	85	120	35	1.1	100				109 800	244 200	4 000	1 280
	-	NA 5917	-	-	-	85	120	46	1.1	100	-0.020			144 000	346 000	4 000	1 760
	-	-	NA 6917	-	-	85	120	63	1.1	100				172 600	466 800	4 000	2 340

* Suitable for oil lubrication. In case of grease lubrication, down to 60% of this value

09 | Needle Roller Bearing

Needle Roller Bearings

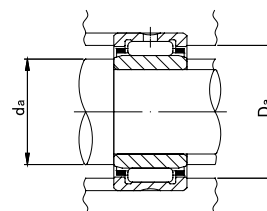
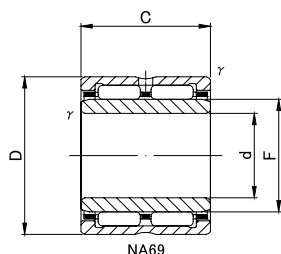
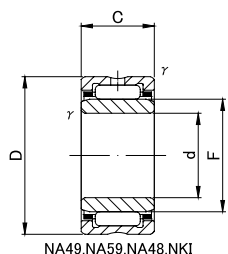

Shaft Diameter (mm)	Bearing No.					Dimensions (mm)					Standard mounting dimensions (mm)			Basic dynamic load rating	Basic Static load rating	Limiting speed	Weight g (approx)
	NA 49	NA 59	NA 69	NA 48	NKI	d	D	C	rs min	F	da		Cr	Cor	* rpm		
											Min	Max	Max	N			N
90	-	-	-	-	NKI 90/26	90	120	26	1	100				82 500	168 700	4 000	820
	-	-	-	-	NKI 90/36	90	120	36	1	100				109 800	244 200	4 000	1 140
	NA 4918	-	-	-	-	90	125	35	1.1	105				112 800	257 900	3 800	1 350
	-	NA 5918	-	-	-	90	125	46	1.1	105	0			148 000	365 000	3 800	1 840
	-	-	NA 6918	-	-	90	125	63	1.1	105	-0.020			177 500	490 300	3 800	2 460
	-	-	-	-	-	-	-	-	-	-	-			-	-	-	-
95	-	-	-	-	NKI 95/26	95	125	26	1	105				84 700	177 500	3 800	860
	-	-	-	-	NKI 95/36	95	125	36	1	105				112 800	257 900	3 800	1 190
	NA 4919	-	-	-	-	95	130	35	1.1	110				116 700	270 700	3 600	1 420
	-	NA 5919	-	-	-	95	130	46	1.1	110	0			152 000	384 000	3 600	1 980
	-	-	NA 6919	-	-	95	130	63	1.1	110	-0.020			182 400	514 800	3 600	2 580
	-	-	-	-	-	-	-	-	-	-	-			-	-	-	-
100	-	-	-	-	NKI 100/30	100	130	30	1.1	110				105 900	239 300	3 600	1 040
	-	-	-	-	NKI 100/40	100	130	40	1.1	110	0			133 400	323 600	3 600	1 380
	NA 4920	-	-	-	-	100	140	40	1.1	115	-0.020			145 000	329 000	3 500	1 960
110	-	-	-	NA 4822	-	110	140	30	1	120	0			93 000	239 000	3 500	1 200
	NA 4922	-	-	-	-	110	150	40	1.1	125	-0.020			152 000	357 000	3 000	2 120
120	-	-	-	NA 4824	-	120	150	30	1	130	0			97 000	259 000	3 000	1 300
	NA 4924	-	-	-	-	120	165	45	1.1	135	-0.020			187 000	435 000	3 000	2 960
130	-	-	-	NA 4826	-	130	165	35	1.1	145	0			117 000	340 000	3 000	1 960
	NA 4926	-	-	-	-	130	180	50	1.5	150	-0.025			216 000	540 000	2 500	4 030
140	-	-	-	NA 4828	-	140	175	35	1.1	155	0			121 000	363 000	2 500	2 100
	NA 4928	-	-	-	-	140	190	50	1.5	160	-0.025			224 000	580 000	2 500	4 290
150	-	-	-	NA 4830	-	150	190	40	1.1	165	0			168 000	446 000	2 500	2 880
						150	190	40	1.1	165	-0.025						
160	-	-	-	NA 4832	-	160	200	40	1.1	175	0			173 000	474 000	2 500	3 050
						160	200	40	1.1	175	-0.025						

* Suitable for oil lubrication. In case of grease lubrication, down to 60% of this value

Needle Roller Bearings

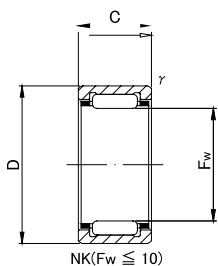

NK(F_w ≤ 10)

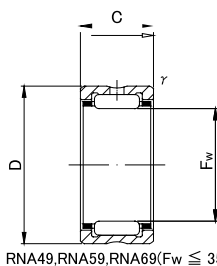

RNA49, RNA59, RNA69 (F_w ≤ 35), NK

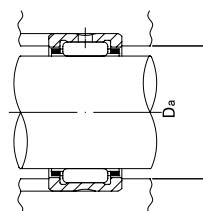

Shaft Diameter (mm)	Bearing No.					Dimensions (mm)					Standard Mounting Dimensions (mm) DaMax	Basic dynamic load rating Cr N	Basic Static load rating Cor N	Limiting speed * rpm	Weight g (approx)					
	RNA 49	RNA 59	RNA 69	RNA 48	NK	Fw	D	C	r s min											
5	-	-	-	-	NK5/10	5	+0.018	10	10	0.15	6.5	2 420	1 950	40 000	3.40					
	-	-	-	-	NK5/12	5	+0.010	10	12	0.15						6.5	3 080	2 660	40 000	4.20
6	-	-	-	-	NK6/10	6	+0.018	12	10	0.015	7.5	2 700	2 320	37 000	5.30					
	-	-	-	-	NK6/12	6	+0.010	12	12	0.15						7.5	3 440	3 170	37 000	6.40
7	RNA 495	-	-	-	-	7		13	10	0.15	8.5	2 960	2 690	34 000	5.90					
	-	-	-	-	NK7/10	7	+0.022	14	10	0.3						8.5	3 600	2 960	34 000	6.90
	-	-	-	-	NK7/12	7	+0.13	14	12	0.3						8.5	4 610	4 050	34 000	8.30
8	RNA 496	-	-	-	-	8		15	10	0.15	13.8	3 900	3 400	32 000	7.30					
	-	-	-	-	NK8/12	8	+0.022	15	12	0.3						13	5 100	4 700	32 000	9.00
	-	-	-	-	NK8/16	8	+0.13	15	16	0.3						13	7 100	7 300	32 000	13.0
9	RNA 497	-	-	-	-	9		16	12	0.3	14	5 500	5 300	30 000	10.0					
	-	-	-	-	NK9/12	9	+0.022	16	16	0.3						14	7 600	8 200	30 000	13.2
	-	-	-	-	NK9/16	9	+0.13	17	10	0.15						15.8	4 500	3 600	30 000	9.30
10	RNA 498	-	-	-	-	10		17	12	0.3	15	5 900	6 000	28 000	10.7					
	-	-	-	-	NK10/12	10	+0.022	17	16	0.3						15	8 200	9 200	28 000	14.3
	-	-	-	-	NK10/16	10	+0.13	19	11	0.2						17.4	6 200	5 000	28 000	12.6
12	RNA 499	-	-	-	-	12		19	12	0.3	17	6 600	7 300	26 000	12.2					
	-	-	-	-	NK12/12	12	+0.027	19	16	0.3						17	9 200	11 200	26 000	16.3
	-	-	-	-	NK12/16	12	+0.16	20	11	0.3						18	6 600	6 300	26 000	13.6

* Suitable for oil lubrication. In case of grease lubrication, down to 60% of this value

Needle Roller Bearings

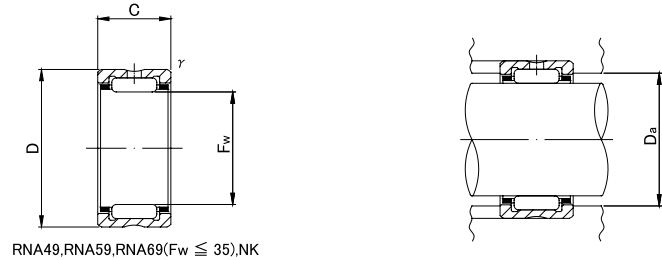

Shaft Diameter (mm)	Bearing No.					Dimensions (mm)				Standard Mounting Dimensions (mm) DaMax	Basic dynamic load rating Cr N	Basic Static load rating Cor N	Limiting speed * rpm	Weight g (approx)	
	RNA 49	RNA 59	RNA 69	RNA 48	NK	Fw	D	C	rs min						
14	RNA 4900	-	-	-	-	14		22	13	0.3	20	9 200	10 100	24 000	16.5
	-	-	-	-	NK14/16	14	+0.027	22	16	0.3	20	11 800	13 700	24 000	21.0
	-	-	-	-	NK14/20	14	+0.016	22	20	0.3	20	14 800	18 500	24 000	26.5
15	-	-	-	-	NK15/16	15	+0.027	23	16	0.3	21	12 400	14 900	23 000	22.5
	-	-	-	-	NK15/20	15	+0.016	23	20	0.3	21	15 600	20 200	23 000	28.0
16	RNA 4901	-	-	-	-	16		24	13	0.3	22	9 700	11 100	23 000	18.1
	-	-	-	-	NK16/16	16	+0.027	24	16	0.3	22	12 300	15 100	23 000	23.0
	-	-	-	-	NK16/20	16	+0.016	24	20	0.3	22	15 600	20 400	23 000	29.0
	-	-	RNA 6901	-	-	16		24	22	0.3	22	17 100	23 000	23 000	30.0
17	-	-	-	-	NK17/16	17	+0.027	25	16	0.3	23	12 800	16 300	22 000	24.5
	-	-	-	-	NK17/20	17	+0.016	25	20	0.3	23	16 300	22 100	22 000	30.5
18	-	-	-	-	NK18/16	18	+0.027	26	16	0.3	24	13 400	17 500	21 000	25.5
	-	-	-	-	NK18/20	18	+0.016	26	20	0.3	24	17 000	23 600	21 000	32.0
19	-	-	-	-	NK19/16	19	+0.033	27	16	0.3	25	14 000	18 700	21 000	27.0
	-	-	-	-	NK19/20	19	+0.020	27	20	0.3	25	17 700	25 300	21 000	34.0
20	RNA 4902	-	-	-	-	20		28	13	0.3	26	10 900	13 800	20 000	21.5
	-	-	-	-	NK20/16	20		28	16	0.3	26	13 900	18 700	20 000	27.5
	-	RNA 5902	-	-	-	20	+0.033	28	18	0.3	26	15 700	22 100	20 000	33.0
	-	-	-	-	NK20/20	20	+0.020	28	20	0.3	26	17 600	25 400	20 000	35.5
	-	-	RNA 6902	-	-	20		28	20	0.3	26	17 600	25 400	20 000	35.5
	-	-	-	-	-	20		28	23	0.3	26	19 300	28 700	20 000	37.0

* Suitable for oil lubrication. In case of grease lubrication, down to 60% of this value

Needle Roller Bearings

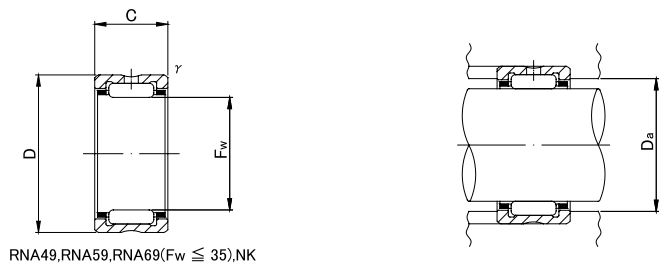

RNA49, RNA59, RNA69 (Fw ≤ 35), NK

Shaft Diameter (mm)	Bearing No.					Dimensions (mm)				Standard Mounting Dimensions (mm)	Basic dynamic load rating	Basic Static load rating	Limiting speed * rpm	Weight g (approx)						
	RNA 49	RNA 59	RNA 69	RNA 48	NK	Fw	D	C	rs min											
21	-	-	-	-	NK21/16	21	+0.033	29	16	0.3	27	14 400	20 000	19 000	29.0					
	-	-	-	-	NK21/16	21	+0.020	29	20	0.3						27	18 200	27 100	19 000	36.0
22	RNA 4903	-	-	-	-	22	-	30	13	0.3	28	11 800	15 600	18 000	23.5					
	-	-	-	-	NK22/16	22	-	30	16	0.3						28	14 900	21 200	18 000	30.0
	-	RNA 5902	-	-	-	22	+0.033	30	18	0.3						28	16 900	24 900	18 000	35.0
	-	-	-	-	NK22/20	22	+0.020	30	20	0.3						28	18 900	28 700	18 000	37.5
	-	-	RNA 6903	-	-	22	-	30	23	0.3						28	20 800	23 500	18 000	40.5
24	-	-	-	-	NK24/16	24	+0.033	32	16	0.3	30	15 300	22 600	17 000	32.0					
	-	-	-	-	NK24/20	24	+0.020	32	20	0.3						30	19 400	30 500	17 000	40.5
25	-	-	-	-	NK25/16	25	-	33	16	0.3	31	15 800	23 700	16 000	33.5					
	-	-	-	-	NK25/20	25	+0.033	33	20	0.3						31	20 000	32 200	16 000	42.0
	RNA 4904	-	-	-	-	25	-	37	17	0.3						35	21 000	25 000	16 000	55.5
	-	RNA 5904	-	-	-	25	+0.020	37	23	0.3						35	29 400	38 600	16 000	84.0
	-	-	RNA 6904	-	-	25	-	37	30	0.3						35	35 400	48 800	16 000	95.5
26	-	-	-	-	NK26/16	26	+0.033	34	16	0.3	32	16 300	24 900	15 000	34.5					
	-	-	-	-	NK26/20	26	+0.020	34	20	0.3						32	20 600	33 700	15 000	43.5
28	-	-	-	-	NK28/20	28	-	37	20	0.3	35	21 700	37 100	14 000	51.5					
	-	-	-	-	NK28/30	28	+0.033	37	30	0.3						35	31 100	58 900	14 000	83.5
	RNA 49/22	-	-	-	-	28	-	39	17	0.3						37	21 400	28 800	14 000	56.5
	-	RNA 59/22	-	-	-	28	+0.020	39	23	0.3						37	29 800	44 400	14 000	92.0
	-	-	RNA 69/22	-	-	28	-	39	30	0.3						37	36 300	56 900	14 000	97.5
29	-	-	-	-	NK29/20	29	+0.033	38	20	0.3	36	21 600	37 200	14 000	57.0					
	-	-	-	-	NK29/30	29	+0.020	38	30	0.3						36	30 900	59 000	14 000	85.0

* Suitable for oil lubrication. In case of grease lubrication, down to 60% of this value

Needle Roller Bearings

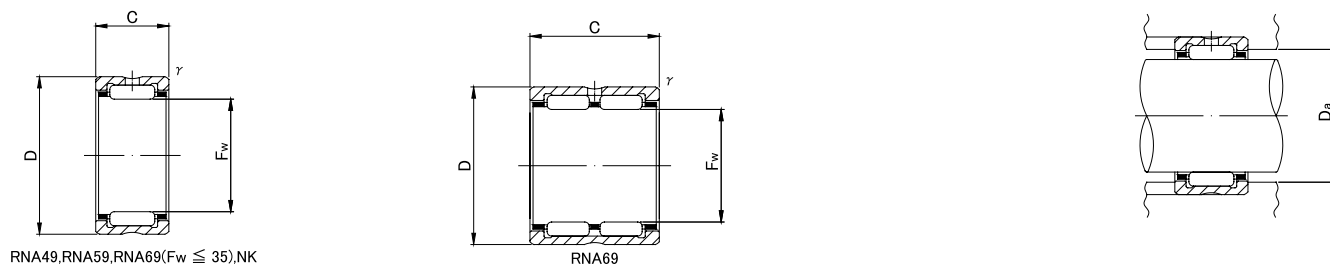

Shaft Diameter (mm)	Bearing No.					Dimensions (mm)				Standard Mounting Dimensions (mm) DaMax	Basic dynamic load rating Cr N	Basic Static load rating Cor N	Limiting speed * rpm	Weight g (approx)	
	RNA 49	RNA 59	RNA 69	RNA 48	NK	Fw	D	C	r s min						
30	-	-	-	-	NK30/20	30		40	20	0.3	38	25 100	40 100	13 000	64.5
	-	-	-	-	NK30/30	30		40	30	0.3	38	36 000	63 800	13 000	97.5
	RNA 4905	-	-	-	-	30	+0.033	42	17	0.3	40	23 700	30 700	13 000	64.0
	-	RNA 5905	-	-	-	30	+0.020	42	23	0.3	40	33 200	47 500	13 000	101
	-	-	RNA 6905	-	-	30		42	30	0.3	40	42 100	64 200	13 000	111
32	-	-	-	-	NK32/20	32		42	20	0.3	40	25 700	42 200	13 000	68.0
	-	-	-	-	NK32/30	32		42	30	0.3	40	36 900	67 100	13 000	102
	RNA 49/28	-	-	-	-	32	+0.041	45	17	0.3	43	24 500	32 700	13 000	76.5
	-	RNA 59/28	-	-	-	32	+0.025	45	23	0.3	43	34 300	50 500	13 000	108
	-	-	RNA 69/28	-	-	32		45	30	0.3	43	41 800	64 700	13 000	133
35	-	-	-	-	NK35/20	35		45	20	0.3	43	27 000	46 200	11 000	73.5
	-	-	-	-	NK35/30	35		45	30	0.3	43	38 600	73 500	11 000	112
	RNA 4906	-	-	-	-	35	+0.041	47	17	0.3	45	25 200	34 700	11 000	72.5
	-	RNA 5906	-	-	-	35	+0.025	47	23	0.3	45	35 200	53 700	11 000	108
	-	-	RNA 6906	-	-	35		47	30	0.3	45	43 100	69 000	11 000	125
37	-	-	-	-	NK37/20	37	+0.041	47	20	0.3	45	28 200	51 100	11 000	77.5
	-	-	-	-	NK37/30	37	+0.025	47	30	0.3	45	40 500	79 800	11 000	117
38	-	-	-	-	NK38/20	38	+0.041	48	20	0.3	46	28 100	52 200	11 000	79.0
	-	-	-	-	NK38/30	38	+0.025	48	30	0.3	46	40 300	80 000	11 000	119
40	-	-	-	-	NK40/20	40		50	20	0.3	48	29 400	54 100	10 000	83.0
	-	-	-	-	NK40/30	40		50	30	0.3	48	42 300	86 100	10 000	125
	RNA 49/32	-	-	-	-	40	+0.041	52	20	0.6	48	31 300	47 900	10 000	96.0
	-	RNA 59/32	-	-	-	40	+0.025	52	27	0.6	48	41 900	69 900	10 000	149
	-	-	RNA 69/32	-	-	40		52	36	0.6	48	53 500	95 700	10 000	172
42	-	-	-	-	NK42/20	42		52	20	0.3	50	29 900	56 200	9 500	86.5
	-	-	-	-	NK42/30	42		52	30	0.3	50	43 000	89 500	9 500	130
	RNA 4907	-	-	-	-	42	+0.041	55	20	0.6	51	32 000	50 200	9 500	113
	-	RNA 5907	-	-	-	42	+0.025	55	27	0.6	51	42 900	73 200	9 500	176
	-	-	RNA 6907	-	-	42		55	36	0.6	51	54 800	100 000	9 500	200

* Suitable for oil lubrication. In case of grease lubrication, down to 60% of this value

Needle Roller Bearings

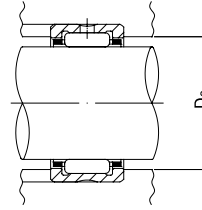
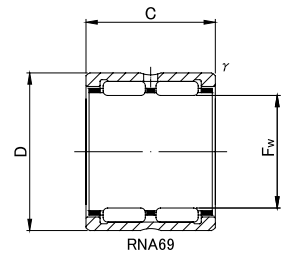
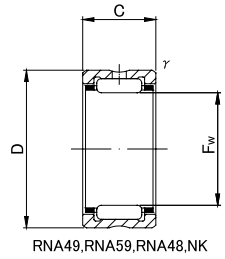

Shaft Diameter (mm)	Bearing No.					Dimensions (mm)				Standard Mounting Dimensions (mm)	Basic dynamic load rating	Basic Static load rating	Limiting speed * rpm	Weight g (approx)						
	RNA 49	RNA 59	RNA 69	RNA 48	NK	Fw	D	C	rs min											
43	-	-	-	-	NK43/20	43	+0.041	53	20	0.3	51	30 500	58 100	9 500	88.5					
	-	-	-	-	NK43/30	43	+0.025	53	30	0.3						51	43 700	92 500	9 500	133
45	-	-	-	-	NK45/20	45	+0.041	55	20	0.3	53	31 100	60 100	9 000	92.0					
	-	-	-	-	NK45/30	45	+0.025	55	30	0.3						53	44 500	95 700	9 000	138
47	-	-	-	-	NK47/20	47	+0.041	57	20	0.3	55	31 500	62 300	8 500	95.0					
	-	-	-	-	NK47/30	47	+0.025	57	30	0.3						55	45 200	99 000	8 500	144
48	RNA 4908	-	-	-	-	48	+0.041	62	22	0.6	58	41 600	67 400	8 500	152					
	-	RNA 5908	-	-	-	48	+0.041	62	30	0.6						58	58 000	10 300	8 500	225
	-	-	RNA 6908	-	-	48	+0.025	62	40	0.6						58	71 300	134 400	8 500	275
50	-	-	-	-	NK48/20	50	+0.041	62	25	0.6	58	43 000	85 200	8 000	159					
	-	-	-	-	NK48/30	50	+0.025	62	25	0.6						58	58 100	125 500	8 000	225
52	RNA 4909	-	-	-	-	52	+0.049	68	22	0.6	64	43 500	73 400	7 500	197					
	-	RNA 5909	-	-	-	52	+0.030	68	30	0.6						64	60 700	112 000	7 500	232
	-	-	RNA 6909	-	-	52	+0.030	68	40	0.6						64	74 600	147 100	7 500	355
55	-	-	-	-	NK55/20	55	+0.049	68	25	0.6	64	45 400	94 100	7 500	193					
	-	-	-	-	NK55/30	55	+0.030	68	35	0.6						64	61 300	138 300	7 500	255

* Suitable for oil lubrication. In case of grease lubrication, down to 60% of this value

Needle Roller Bearings

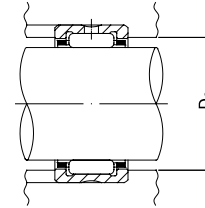
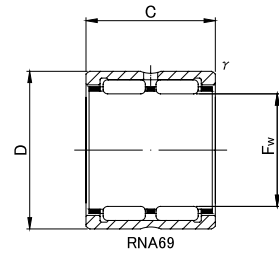
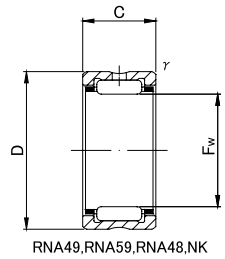

Shaft Diameter (mm)	Bearing No.					Dimensions (mm)				Standard Mounting Dimensions (mm)	Basic dynamic load rating	Basic Static load rating	Limiting speed * rpm	Weight g (approx)	
	RNA 49	RNA 59	RNA 69	RNA 48	NK	Fw	D	C	r s min						DsMax
58	RNA 4910	-	-	-	-	58	+0.049	72	22	0.6	68	46 200	82 100	7 000	179
	-	RNA 5910	-	-	-	58	+0.030	72	30	0.6	68	64 400	126 000	7 000	289
	-	-	RNA 6910	-	-	58	+0.030	72	40	0.6	68	79 100	163 800	7 000	32.0
60	-	-	-	-	NK60/25	60	+0.049	72	25	0.6	68	47 500	103 000	6 500	187
	-	-	-	-	NK60/35	60	+0.030	72	35	0.6	68	64 100	151 000	6 500	260
63	RNA 4911	-	-	-	-	63	+0.049	80	25	1	75	57 600	97 300	6 500	265
	-	RNA 5911	-	-	-	63	+0.030	80	34	1	75	82 600	154 000	6 500	367
	-	-	RNA 6911	-	-	63	+0.030	80	45	1	75	99 000	194 000	6 500	475
65	-	-	-	-	NK65/25	65	+0.049	78	25	0.6	74	49 600	111 800	6 000	225
	-	-	-	-	NK65/35	65	+0.030	78	35	0.6	74	67 000	164 800	6 000	315
68	-	-	-	-	NK68/25	68		82	25	0.6	78	54 800	116 700	6 000	250
	-	-	-	-	NK68/35	68		82	35	0.6	78	72 100	165 700	6 000	350
	RNA 4912	-	-	-	-	68	+0.049	85	25	1	80	60 100	104 900	6 000	285
	-	RNA 5912	RNA 6912	-	-	68	+0.030	85	34	1	80	86 100	167 000	6 000	408
	-	-	-	-	-	68		85	45	1	80	103 000	210 800	6 000	510
70	-	-	-	-	NK70/25	70	+0.049	85	25	0.6	81	55 500	120 600	5 500	280
	-	-	-	-	NK70/35	70	+0.030	85	35	0.6	81	73 000	170 600	5 500	395
72	RNA 4913	-	-	-	-	72	+0.049	90	25	1	85	62 800	113 800	5 500	325
	-	RNA 5913	-	-	-	72	+0.030	90	34	1	85	89 900	180 000	5 500	462
	-	-	RNA 6913	-	-	72	+0.030	90	35	1	85	107 900	226 500	5 500	585

* Suitable for oil lubrication. In case of grease lubrication, down to 60% of this value

Needle Roller Bearings

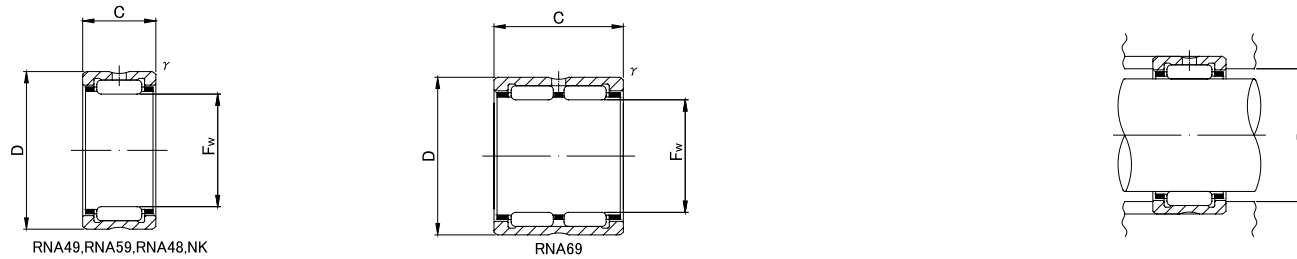

Shaft Diameter (mm)	Bearing No.					Dimensions (mm)				Standard Mounting Dimensions (mm)	Basic dynamic load rating Cr N	Basic Static load rating Cor N	Limiting speed * rpm	Weight g (approx)						
	RNA 49	RNA 59	RNA 69	RNA 48	NK	Fw	D	C	rs min											
73	-	-	-	-	NK73/25	73	+0.049	90	25	0.6	86	61 100	126 500	5 500	335					
	-	-	-	-	NK73/35	73	+0.030	90	35	0.6						86	80 400	180 400	5 500	475
75	-	-	-	-	NK75/25	75	+0.049	92	25	0.6	88	62 200	130 400	5 500	345					
	-	-	-	-	NK75/35	75	+0.030	92	35	0.6						88	82 700	186 300	5 500	485
80	-	-	-	-	NK80/25	80		95	25	1	90	59 400	137 300	5 000	315					
	-	-	-	-	NK80/35	80	+0.049	95	35	1						90	78 100	194 200	5 000	445
	RNA 4914	-	-	-	-	80	+0.030	100	30	1						95	83 200	157 900	5 000	495
	-	RNA 5914	-	-	-	80		100	40	1						95	112 000	232 000	5 000	706
	-	-	RNA 6914	-	-	80		100	54	1						95	133 400	310 900	5 000	910
	-	-	-	-	-	80		100	54	1						95	133 400	310 900	5 000	910
85	-	-	-	-	NK85/25	85		105	25	1	100	76 400	145 100	4 500	435					
	RNA 4915	-	-	-	-	85	+0.058	105	35	1						100	86 200	169 700	4 500	525
	-	-	-	-	NK85/35	85	+0.036	105	30	1						100	102 000	209 900	4 500	610
	-	RNA 5915	-	-	-	85		105	40	1						100	116 000	249 000	4 500	745
	-	-	RNA 6915	-	-	85		105	54	1						100	138 300	330 500	4 500	960
	-	-	-	-	-	85		105	54	1						100	138 300	330 500	4 500	960
90	-	-	-	-	NK90/25	90		110	25	1	105	77 400	150 000	4 500	456					
	RNA 4916	-	-	-	-	90	+0.058	110	35	1						105	87 400	174 600	4 500	550
	-	-	-	-	NK90/35	90	+0.036	110	30	1						105	103 000	216 700	4 500	640
	-	RNA 5916	-	-	-	90		110	40	1						105	117 000	257 000	4 500	787
	-	-	RNA 6916	-	-	90		110	54	1						105	143 200	350 100	4 500	1 010
	-	-	-	-	-	90		110	54	1						105	143 200	350 100	4 500	1 010
95	-	-	-	-	NK95/26	95	+0.058	115	26	1	110	79 700	158 900	4 200	495					
	-	-	-	-	NK95/36	95	+0.036	115	36	1						110	106 900	230 500	4 200	690
100	-	-	-	-	NK100/26	100		120	26	1	115	82 500	168 700	4 000	525					
	RNA 4917	-	-	-	-	100	+0.058	120	35	1.1						113.5	109 800	244 200	4 000	705
	-	-	-	-	NK100/36	100	+0.036	120	36	1						115	109 900	244 200	4 000	725
	-	RNA 5917	-	-	-	100		120	46	1.1						113.5	144 000	346 000	4 000	1 000
	-	-	RNA 6917	-	-	100		120	63	1.1						113.5	172 600	466 800	4 000	1 300
	-	-	-	-	-	100		120	63	1.1						113.5	172 600	466 800	4 000	1 300

* Suitable for oil lubrication. In case of grease lubrication, down to 60% of this value

Needle Roller Bearings

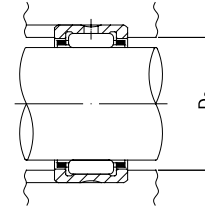
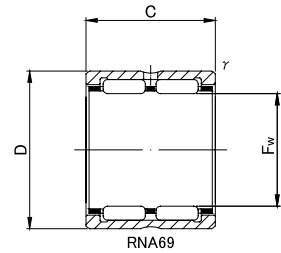
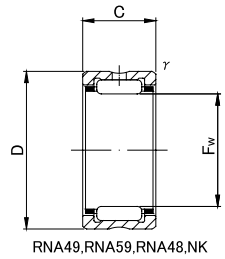

Shaft Diameter (mm)	Bearing No.					Dimensions (mm)				Standard Mounting Dimensions (mm)	Basic dynamic load rating	Basic Static load rating	Limiting speed * rpm	Weight g (approx)	
	RNA 49	RNA 59	RNA 69	RNA 48	NK	Fw	D	C	r ^s min						
105	-	-	-	-	NK105/26	105	125	26	1	120	84 700	177 500	3 800	545	
	RNA 4918	-	-	-	-	105	125	35	1.1	118.5	112 800	257 900	3 800	740	
	-	-	-	-	NK105/36	105	+0.058	125	36	1	120	112 800	257 900	3 800	760
	-	RNA 5918	-	-	-	105	+0.036	125	46	1.1	118.5	148 000	365 000	3 800	1 040
	-	-	RNA 6918	-	-	105	-	125	63	1.1	118.5	177 500	490 300	3 800	1 360
	-	-	-	-	-	105	-	125	63	1.1	118.5	177 500	490 300	3 800	1 360
110	-	-	-	-	NK110/30	110	130	30	1.1	123.5	105 900	239 300	3 600	660	
	RNA 4919	-	-	-	-	110	130	35	1.1	123.5	116 700	270 700	3 600	770	
	-	-	-	-	NK110/40	110	+0.058	130	40	1.1	123.5	133 400	323 600	3 600	880
	-	RNA 5919	-	-	-	110	+0.036	130	46	1.1	123.5	152 000	384 000	3 600	1 130
	-	-	RNA 6919	-	-	110	-	130	63	1.1	1123.5	182 400	514 800	3 600	1 420
	-	-	-	-	-	110	-	130	63	1.1	1123.5	182 400	514 800	3 600	1 420
115	RNA 4920	-	-	-	-	115	+0.058 +0.036	140	40	1.1	133.5	145 000	329 000	3 500	1 190
120	-	-	-	RNA 4822	-	120	+0.058 +0.036	140	30	1	135	93 000	239 000	3 500	790
125	RNA 4922	-	-	-	-	125	+0.068 +0.036	150	40	1.1	143.5	152 000	357 000	3 000	1 280
130	-	-	-	RNA 4824	-	130	+0.068 +0.036	150	30	1	145	97 000	259 000	3 000	850
135	RNA 4924	-	-	-	-	135	+0.068 +0.036	165	45	1.1	158.5	187 000	435 000	1 930	1 930

* Suitable for oil lubrication. In case of grease lubrication, down to 60% of this value

Needle Roller Bearings

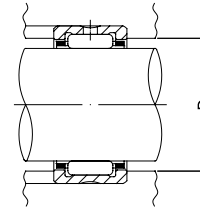
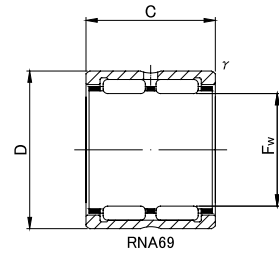
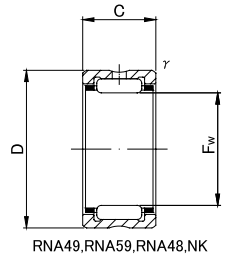

Shaft Diameter (mm)	Bearing No.					Dimensions (mm)				Standard Mounting Dimensions (mm)	Basic dynamic load rating	Basic Static load rating	Limiting speed * rpm	Weight g (approx)	
	RNA 49	RNA 59	RNA 69	RNA 48	NK	Fw	D	C	r _S min						
145	-	-	-	RNA 4826	-	145	+0.068 +0.043	165	35	1.1	158.5	117 000	340 000	3 000	1 100
150	RNA 4926	-	-	-	-	150	+0.068 +0.043	180	50	1.5	172	216 000	540 000	2 500	2 360
155	-	-	-	RNA 4828	-	155	+0.068 +0.043	175	35	1.1	168.5	121 000	363 000	2 500	1 170
160	RNA 4928	-	-	-	-	160	+0.068 +0.043	190	50	1.5	182	224 000	580 000	2 500	2 500
165	-	-	-	RNA 4830	-	165	+0.068 +0.043	190	40	1.1	183.5	168 000	446 000	2 500	1 750
175	-	-	-	RNA 4832	-	175	+0.068 +0.043	200	40	1.1	193.5	173 000	474 000	2 500	1 850

* Suitable for oil lubrication. In case of grease lubrication, down to 60% of this value

Insert Ball Bearing Units

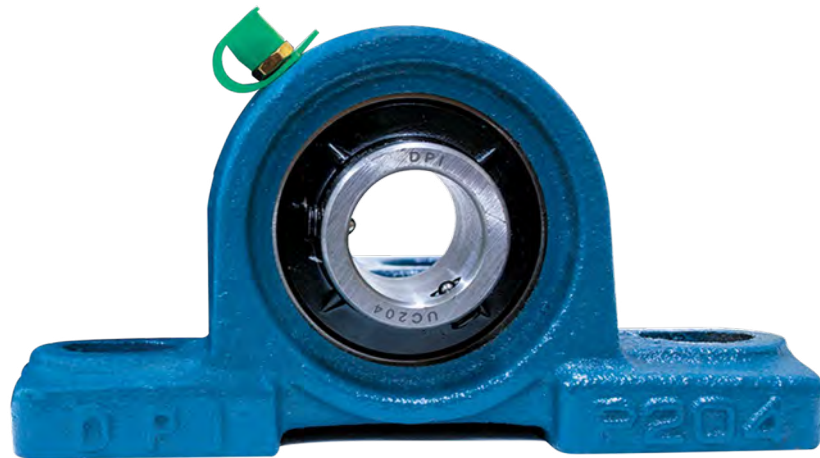

10 | Insert Ball Bearing Units

Insert Ball Bearing Units

Insert ball bearing unit is consist of a double sealed, single row bearing and one of various types of housings (Cast iron housing, Stamping steel housing, Stainless steel housing, Engineering plastic block, Nodular cast iron housing, Nickel plating housing, Zinc alloy block, etc.)



Bearing Units Structure

The outer ring of the self-contained ball bearings is ground to a sphere and the bore of housing is machined to a matching radius. This permits self-aligning between the two members. Above figure is a view of a Pillow Block which is the most popular type of Insert Ball Bearing Units with set screw locking. The bearing units have various types of perfect sealing devices and can operate satisfactorily under hardworking conditions, especially for machines operated in dusty or muddy surroundings. Thus, they are widely used in agricultural machinery, construction machinery, textile machinery, foodstuff machinery and conveying devices, etc.

Note:

1. When the fit between bearing and housing is clearance fit, the bearing's outer ring has anti-rotation ball (pin).
2. Two set screws on the wide inner ring at 120 °C apart.
3. Usually, The Outer ring of the DPI Bearings had grease groove, bearing having no grease groove are to be provided too.

11 | Insert Ball Bearing Units

The Features of Products

Rational Self - Alignment

The outside diameter of the self-contained bearing is spherical to match corresponding spherical inside diameter of the housing providing self-aligning between these two members, which compensates for misalignments of the units resulted from errors in mounting and distorting of the foundation.

Large load carrying capacity

Being the same as 6200 and 6300 series single row deep groove ball bearing in internal construction of the self-contained bearings, Insert ball bearing units can sustain radial loads and sustain thrust loads as well. And they are low noise during operating.

Longer Service Life

Insert ball bearing units are often used in severe operating conditions where they are exposed to dirt, moisture and high temperature and in such applications, the grease inside the self-contained bearing deteriorates in a short time. It is required that relubricate the units at suitable intervals so as to replace deteriorating grease with fresh grease. Insert ball bearing units with cast iron housings are all relubricable types equipped with grease fitting to secure full performance and longer service life of the units under any operating conditions.

Insert Ball Bearing Units

Housings		Cast Iron Housings						Pressed Steel Plate Housing			
		P,PK,LP	PA,PG,PA-A	F,FU	FL,FLU,LF,FD	FC	T,ST,K	PP	PFL	PF	PFT
Setscrew Type	UC	UCP UCPK	UCPA UCPA-A UCPG	UCF	UCFL	UCFC	UCT UCST UCK				
	UCX	UCPX		UCFX							
	SB,SB-G	SBP-G SBLP-G			SBFL-G SBLF-G SBFD-G			SBPP	SBPFL	SBPF	SBPFT
Eccentric Locking Collar Type	NA	NAP NAPK		NAK NAFU	NAFL ANFLU	NAFC	NAT				
	SA,SA-G	SAP-G SALP-G		SAF-G	SALF-G SAFD-G			SAPP	SAPFL	SAPF	SAPFT
Adapter Type	UK	UKP+H		UKF+H	UKFL+H	UKFC+H					
	UK	UKP+H		UKF+H	UKFL+H						

Others	UCPH	SALFTC-G SBLFTC-G	SAPFTD-G SBFTD-G	UCC	UCFB	UCFA	UCHA	Disk Harrow Units	Farm Implement Ball Bearings
	HC	RB	ER SER	CSB	CSA CSA-F	CS-2RS	ORAE	NAA	Eccentric locking collar A200 A300 Adaper Sleeve Locking H2300

11 | Insert Ball Bearing Units

Types of Insert Ball Bearing Units



1. Pillow Blocks

UCP, NAP,UKP+H,SBP-G,SAP-G, UCPK, NAPK,UCAK, NAAK, UCPX,SALP-G,SBLP-G, UCP,NAF,UKP+H

Pillow blocks are most extensively used among the bearing units, UCP, UCPK, UCAK and SBLPG, these types are fixed to the shafts by means of the setscrews prepared in the inner ring, NAPK and SALP-G type are fixed to the shafts by use of setscrews prepared in the eccentric locking collar. UKP type is announced to the shafts by use of adapter sleeve



2. High center height pillow blocks

UCPH, NAPH, UKPH+H

It is one type of pillow blocks with higher center height.



3. Tapped-base pillow blocks

UCPA, NAPA, UKPA+H, UCPA-A, UCPG

It has compact structure, saving mounting space. It can be fitted with bolts from the underneath of the base



4. Square flange units

UCF, NAF, NAFU, UKF+H, SAF-G, UCFX

These bearing units are designed to fix at the sides of the machine which are to the center of the shafts by means of 4 bolts. The mounting method is widely used in the machines. The setscrews, the eccentric locking collar and the adapter sleeve bearings have the same mounting method as the P housings do.



5. Round flange cartridge units

UCFC, NAFC, UKFC+H

These bearing units are installed in the holes on the side of the places where concentricity demanded,

Types of Insert Ball Bearing Units



6. Oval flange units

UCFL, NAFLU,UKFL+H, SBFLG, NAFL

This type of housing is useful in saving space and weight. It can be installed by means of two bolts. The set bolt pitch is the same as that of the square flange type.



7. LF,FTC,FD,PFTD and PFTD-G type two bolt flange are for use with SB(or SB-G) and SA (or SA-G) type insert ball bearing only.

SALF-G, SBLF-G, SALFTC-G, SBLFTC-G
 SAFD-G, SBFD-G SAPFTD, SBPFTD, OR SAPFTD-G, SBPFTD-G
 LF, LFTC,FD PFTD,PFTD-G

Material: Grey Iron
 Ductile

Bolt Configuration: Round Hole
 Square Hole



8. Flange bracket units

UCFB

This type has three set holes on only one side of the flange. This type of bearing unit used where the mounting space is limited, and the housing can be fixed on only one side,



9. Adjustable flange units

UCFA

This type has two bolt base with one side adjustable, enabling distance from center of shaft to be varied



10. Take up units

UCT, NAT, UCK, UCST

This type is applied to the machines in which the center of main shaft need free alignment.

11 | Insert Ball Bearing Units

Insert Ball Bearings Units

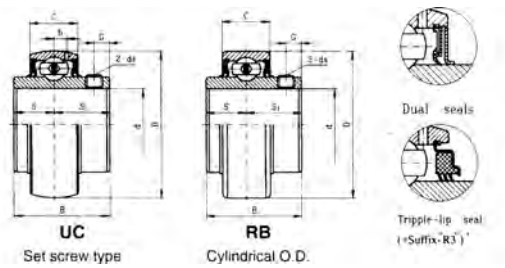

Bearing no.	Shaft Dia.		Dimensions(mm)								Basic load rating (kN)		Weight (Kg)	
	<i>d</i> (in.)	(mm)	D	B	C	S	S ₁	G	H	ds	Dynamic Cr	Static Cr	UC	RB
UC202 RB202-10 203 203-11	5/8 11/16	15 17	40 1.5748	27.4 1.0787	14 0.5512	11.5 0.4528	15.9 0.6260	4.5 0.1772	3.5 0.1378	M5 x 0.8 10# -32UNF	7.35	4.78	0.12 0.12 0.11 0.11	- - - -
UC204-12 RB204	3/4	20	47 1.8540	31 1.2205	16 0.62990	12.7 0.5000	18.3 0.7205	4.7 0.1850	4.4 0.1732	M6 x 1 1/4-28UNF	9.88	6.65	0.18 0.17	0.19 0.18
UC205-14 RB205-15 205 205-16	7/8 15/16 1	25	52 2.0472	34.1 1.3425	17 0.6693	14.3 0.5630	19.8 0.7795	5.5 0.2165	4.3 0.1693	M6 x 1 1/4-28UNF	10.80	7.88	0.23 0.22 0.21 0.20	0.26 0.25 0.24 0.23
UC206-18 RB206 206-19 206-20	1-1/8 1-3/16 1-1/4	30	62 2.4409	38.1 1.5000	19 0.7480	15.9 0.6260	22.2 0.8740	5.5 0.2165	5 0.1969	M6 x 1 1/4-28UNF	15.00	11.20	0.34 0.33 0.31 0.30	0.38 0.36 0.35 0.34
UC207-20 RB207-21 207-22 207 207-23	1-1/4 1-5/16 1-3/8 1-7/16	35	72 2.8346	42.9 1.6890	20 0.7870	17.5 0.6890	25.4 1.0000	6.5 0.2559	5.8 0.2283	M8 x 1 5/16-24UNF	19.80	15.20	0.53 0.51 0.48 0.47 0.45	0.61 0.59 0.56 0.54 0.52
UC208-24 RB208-25 208	1-1/2 1-9/16	40	80 3.1496	49.2 1.9370	21 0.8268	19 0.7480	30.2 1.1890	8 0.3150	6.3 0.2480	M8 x 1 5/16-24UNF	22.80	18.20	0.68 0.65 0.64	0.76 0.74 0.73
UC209-26 RB209-27 209-28 209	1-5/8 1-11/16 1-3/4	45	85 3.3465	49.2 1.9370	22 0.8661	19 0.7480	30.2 1.1890	8 0.3150	6.8 0.2677	M8 x 1 5/16-24UNF	24.50	20.80	0.78 0.74 0.70 0.68	0.88 0.85 0.81 0.79
UC210-30 RB210-31 210 210-32	1-7/8 1-15/16 2	50	90 3.5433	51.6 2.0315	23 0.9055	19 0.7480	32.6 1.2835	9 0.3543	6.5 0.2559	M10 x 1.25 3/8-24UNF	27.00	23.20	0.87 0.82 0.80 0.78	0.98 0.93 0.93 -
UC211-32 RB211-34 211 211-35	2 2-1/8 2-3/16	55	100 3.9370	55.6 2.1890	25 0.9843	22.2 0.8740	33.4 1.3150	9 0.3543	7.2 0.2835	M10 x 1.25 3/8-24UNF	33.50	29.20	1.27 1.17 1.12 1.10	1.40 1.30 1.24 1.22
UC212-36 RB212 212-38 212-39	2-1/4 2-3/8 2-7/16	60	110 4.3307	65.1 2.5630	27 1.0630	25.4 1.0000	39.7 1.5630	10.5 0.4134	8.2 0.3228	M10 x 1.25 3/8-24UNF	36.80	32.80	1.67 1.53 1.53 1.45	1.88 1.74 1.72 1.65
UC213-40 213	2-1/2	65	120 4.7244	65.1 2.5630	28 1.1024	25.4 1.0000	39.7 1.5630	12 0.4724	8 0.3150	M12 x 1.25 7/16-20UNF	44.00	40.00	1.94 1.86	- -
UC214-44 214	2-3/4	70	125 4.9213	74.6 2.9370	30 1.1811	30.2 1.1890	44.4 1.7480	12 0.4724	9 0.3543	M12 x 1.25 7/16-20UNF	46.80	45.00	2.06 2.05	- -
UC215-47 215 215-48	2-15/16 3	75	130 5.1181	77.8 3.0630	30 1.1811	33.3 1.3110	44.5 1.7520	12 0.4724	9 0.3543	M12 x 1.25 7/16-20UNF	50.80	49.50	2.30 2.21 2.13	- - -
UC216		80	140 5.5118	82.6 3.2520	33 1.2992	33.3 1.3110	49.3 1.9410	14 0.5512	10.3 0.4055	M12 x 1.25 7/16-20UNF	55.00	54.20	2.79	-
UC217-52 217	3-1/4	85	150 5.9055	85.7 3.3740	35 1.3740	34.1 1.3425	51.6 2.0315	14 0.5512	11 0.4331	M12 x 1.25 7/16-20UNF	64.00	63.80	3.60 3.38	- -
UC218-56 218	3-1/2	90	160 6.2992	96 3.7795	37 1.4567	39.7 1.5630	56.3 2.2165	14 0.5512	12 0.4724	M12 x 1.25 1/2-20UNF	73.80	71.50	4.56 4.45	- -

11 | Insert Ball Bearing Units

Insert Ball Bearings

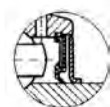
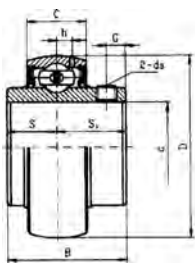

Dual seals

UC Set screw type

Bearing no.	Shaft Dia. <i>d</i>		Dimensions(mm)								Basic load rating (kN)		Weight (Kg)
	(in.)	(mm)	D	B	C	S	S ₁	G	H	ds	Dynamic Cr	Static Cr	
UC305-14 305-15 305 305-16	7/8 15/16 1	25	62 2.4409	38 1.4961	21 0.8268	15 0.5906	23 0.9055	6 0.2362	6.2 0.2441	M6 x 1 1/4-28UNF	17.20	11.50	0.38 0.36 0.35 0.34
UC306-18 306 306-19	1-1/8 1-3/16	30	72 2.8346	43 1.6929	24 0.9449	17 0.6693	26 1.0236	6 0.2362	6.5 0.2559	M6 x 1 1/4-28UNF	20.80	15.20	0.58 0.56 0.56
UC307-20 307-21 307-22 307	1-1/4 1-5/16 1-3/8	35	80 3.1496	48 1.8898	25 0.9843	19 0.7480	29 1.1417	8 0.3150	7.2 0.28350	M8 x 1 5/16-24UNF	25.80	19.20	0.77 0.74 0.71 0.71
UC308-24 308-25 308	1-1/2 1-9/16	40	90 3.5433	52 2.0472	28 1.1024	19 0.7480	33 1.2992	10 0.3937	8.5 0.3346	M10 x 1.25 3/8-24UNF	31.20	24.00	1.00 0.98 0.96
UC309-26 309-27 309-28 309	1-5/8 1-11/16 1-3/4	45	100 3.9370	57 2.2441	30 1.1811	22 0.8661	35 1.3780	10 0.3937	9 0.3543	M10 x 1.25 3/8-24UNF	40.80	31.80	1.36 1.33 1.30 1.28
UC310-30 310-31 310	1-7/8 1-15/16	50	110 4.3307	61 2.4016	32 1.2598	22 0.8661	39 1.5354	12 0.4724	9.9 0.3898	M12 x 1.25 7/16-20UNF	47.50	37.80	1.74 1.68 1.65
UC311-32 311-34 311 311-35	2 2-1/8 2-3/16	55	120 4.7244	66 2.5984	34 1.3386	25 0.9843	41 1.6142	12 0.4724	10.6 0.4173	M12 x 1.25 7/16-20UNF	55.00	44.80	2.08 1.90 1.90 1.87
UC312-36 312 312-38 312-39	2-1/4 2-3/8 2-7/16	60	130 5.1181	71 2.7953	36 1.4173	26 1.0236	45 1.7717	12 0.4724	11.3 0.4449	M12 x 1.25 7/16-20UNF	62.80	51.80	2.65 2.60 2.57 2.50
UC313-40 313	2-1/2	65	140 5.5118	75 2.9528	38 1.4961	30 1.1811	45 1.7717	12 0.4724	12.1 0.4764	M12 x 1.25 7/16-20UNF	72.20	60.50	3.30 3.25
UC314-44 314	2-3/4	70	150 5.9055	78 3.0709	40 1.5748	33 1.2992	47 1.8504	12 0.4724	12.8 0.5039	M12 x 1.25 7/16-20UNF	80.20	68.00	3.96 3.95
UC315 315-48	3	75	160 6.2992	82 3.2283	42 1.6535	32 1.2598	50 1.9685	14 0.5512	13.5 0.5315	M14 x 1.5 1/2-20UNF	87.20	76.80	4.33 4.24
UC316		80	170 6.6929	86 3.3858	44 1.7323	34 1.3386	52 2.0472	14 0.5512	14.5 0.5709	M14 x 1.5 1/2-20UNF	94.50	86.50	5.57
UC317-52 317	3-1/4	85	180 7.0866	96 3.7795	46 1.8110	40 1.5748	56 2.2047	16 0.6299	15.5 0.6102	M16 x 1.5 5/8-18UNF	102.00	96.50	7.08 6.84
UC318-56 318	3-1/2	90	190 7.4803	96 3.7795	48 1.8898	40 1.5748	56 2.2047	16 0.6299	16.5 0.6496	M16 x 1.5 5/8-18UNF	110.00	108.00	8.03 7.87
UC319 319-60	3-3/4	95	200 7.8740	103 4.0551	50 1.9685	41 1.6142	62 2.4409	16 0.6299	18 0.7087	M16 x 1.5 5/8-18UNF	120.00	122.00	8.91 8.88
UC320 320-64	4	100	215 8.4646	108 4.2520	54 2.2160	42 1.6535	66 2.5984	18 0.7087	19 0.7480	M18X1.5 5/8 - 18UNF	132.00	140.00	11.2 11.00
UC321		105	225	112	56	44	68	18	19.1	M18 x 1.5	142	152	
UC322		110	240	117	60	46	71	18	20.6	M18 x 1.5	158	178	
UC324		120	260	126	64	51	75	18	20.6	M18 x 1.5	175	208	
UC326		130	280	135	38	54	81	20	22.2	M20 x 1.5	195	242	
UC328		140	300	145	73	59	86	22	23.8	M20 x 1.5	212	272	

11 | Insert Ball Bearing Units

Insert Ball Bearings

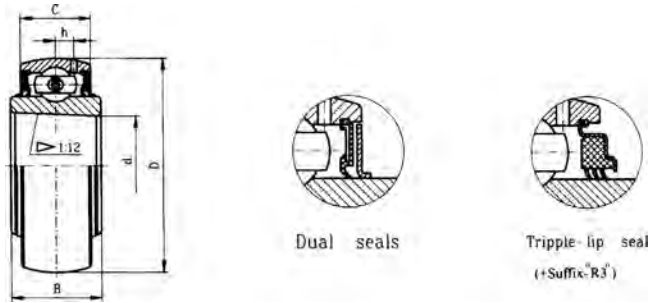

UK Tapered bore

Bearing no.	Dimensions(mm)/(in.)							Basic load rating (kN)		Weight (kg)
	d	D	B		C		h	Dynamic Cr	Static Cr	
			Min	Max	Min	Max				
UK205	25 0.9843	52 2.0472	15 0.5905	27 1.063	15 0.5905	17 0.6693	3.9 0.1535	10.8	7.88	0.15
UK206	30 1.1811	62 2.4409	16 0.63	30 1.1811	16 0.63	19 0.748	5 0.1969	15	11.2	0.25
UK207	35 1.378	72 2.8346	17 0.6693	34 1.3386	17 0.6693	20 0.7874	5.8 0.2283	19.8	15.2	0.37
UK208	40 1.5748	80 3.1496	18 0.7087	36 1.1473	18 0.7087	22 0.8661	6.3 0.248	22.8	18.2	0.48
UK209	45 1.7717	85 3.3465	19 0.748	39 1.5354	19 0.748	22 0.8661	6.4 0.252	24.5	20.8	0.53
UK210	50 1.9685	90 3.5433	20 0.7874	43 1.6929	20 0.7874	24 0.9449	6.5 0.2559	27.0	23.2	0.59
UK211	55 2.1654	100 3.937	21 0.8268	47 1.8504	21 0.8268	25 0.9843	7 0.2756	33.5	29.2	0.77
UK212	60 2.3622	110 4.3307	22 0.8861	49 1.9291	22 0.8861	27 1.063	7.6 0.2992	36.8	32.8	1.03
UK213	65 2.5591	120 4.7244	23 0.9055	51 2.0079	23 0.9055	32 1.2598	8.5 0.3346	44.0	40.0	1.36
UK214	75 2.9528	130 5.1181	25 0.9843	58 2.2835	25 0.9843	34 1.3386	9.2 0.3622	50.8	49.5	1.67
UK215	80 3.1496	140 5.5118	26 1.0236	61 2.4016	26 1.0236	35 1.377	9.5 0.374	55.0	54.2	1.96
UK216	85 3.3465	150 5.9055	28 1.1024	64 2.5197	28 1.1024	36 1.4173	10.2 0.4016	64.0	63.8	2.42
UK217	90 3.5433	160 6.2992	30 1.1811	68 2.6772	30 1.1811	38 1.4961	11.2 0.4409	73.8	71.5	3.00

Insert Ball Bearings

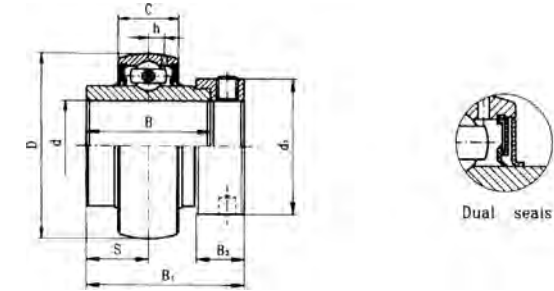

NA Eccentric collar type

Bearing no.	Dimensions(mm)/(in.)					Basic load rating (kN)		Weight (kg)
	d	D	B	C	h	Dynamic Cr	Static Cr	
UK305	25 0.9843	62 2.4409	26 1.063	21 0.8268	6.2 0.2441	17.2	11.5	0.4
UK306	30 1.1811	72 2.8346	29 1.1811	24 0.9449	6.5 0.2559	20.8	15.2	0.46
UK307	35 1.378	80 3.1496	33 1.2992	25 0.9843	7.2 0.2835	25.8	19.2	0.75
UK308	40 1.5748	90 3.5433	34 1.378	28 1.1024	8.5 0.3346	31.2	24	0.81
UK309	45 1.7717	100 3.937	37 1.4961	30 1.1811	9 0.3543	40.8	31.8	1.19
UK310	50 1.9685	110 4.3307	41 1.5748	32 1.2598	9.9 0.3898	47.5	37.8	1.38
UK311	55 2.1654	120 4.7244	44 1.6929	34 1.3386	10.6 0.4173	55.0	44.8	1.78
UK312	60 2.3622	130 5.1181	47 1.8504	36 1.4173	11.3 0.4449	62.8	51.8	2.06
UK313	65 2.5591	140 5.5118	49 1.9291	38 1.4961	12.1 0.4764	72.2	60.5	2.71
UK315	75 2.9528	160 6.2992	55 2.1654	42 1.6535	13.5 0.5315	87.2	76.8	3.98
UK316	80 3.1496	170 6.6929	58 2.1654	44 1.7323	14.5 0.5709	94.5	86.5	4.55
UK317	85 3.3465	180 7.0866	60 2.3622	46 1.811	15.5 0.6102	102.0	96.5	5.44
UK318	90 3.5433	190 7.4803	64 2.3622	48 1.8898	16.5 0.6496	110.0	108	6.25
UK319	95 3.7402	200 7.874	67 2.5984	50 1.9685	18 0.7087	120.0	122	7.31
UK320	100 3.937	215 8.4646	73 2.6772	54 2.126	19 0.748	132.0	140	8.82

11 | Insert Ball Bearing Units

Insert Ball Bearings

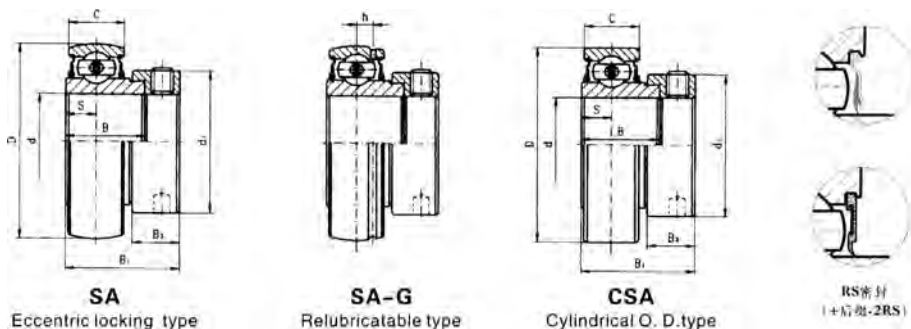

Bearing no.	Shaft Dia. d		Dimensions(mm)/(in.)								Basic load rating (kN)		Weight (Kg)
	(in.)	(mm)	D	C	B	B ₁	S	H	B ₂	d ₁	Dynamic Cr	Static Cr	
SA201 201-08 202 202-10 203 203-11	1/2 5/8 11/16	12 15 17	40 1.5748	13 0.5118	19.1 0.752	28.6 1.126	6.5 0.2559	3.4 0.1338	13.5 0.5315	28.6 1.126	7.35	4.78	0.14 0.14 0.13 0.13 0.13 0.13
CSA104-12	3/4	42 1.6535	12 0.4724	16.14 0.6354	26.42 1.0402	6 0.2362	--	13.2 0.5197	33 1.2992	33 1.2992	7.22	5.00	0.12
SA204-12 204	3/4	20	47 1.8504	14 0.5512	21.4 0.8425	30.9 1.2165	7.5 0.2953	3.7 0.1456	13.5 0.5315	33.3 1.3110	9.88	6.65	0.18 0.15
SA205-14 205-15 205 205-16	7/8 15/16 1	25	52 2.0472	15 0.5906	21.4 0.8425	31.5 1.2402	7.5 0.2953	3.9 0.1535	13.5 0.5315	38.1 1.500	10.80	7.88	0.21 0.19 0.19 0.18
SA206-18 206 206-19 206-20	1-1/8 1-3/16 1-1/4	30	62 2.4409	16 0.6299	23.8 0.9370	35.7 1.4055	9 0.3543	5 0.1969	15.9 0.6260	44.5 1.7520	15.00	11.20	0.35 0.33 0.31 0.29
SA207-20 207-21 207-22 207 207-23	1-1/4 1-5/16 1-3/8 1-7/16	35	72 2.8346	17 0.6693	25.4 1.0000	38.9 1.5315	9.5 0.3740	5.7 0.2244	17.5 0.6890	55.6 2.1890	19.80	15.20	0.56 0.53 0.51 0.50 0.48
SA208-24 208-25 208	1-1/2 1-9/16	40	80 3.1496	18 0.7087	30.2 1.1890	43.7 1.7205	11 0.4331	6.2 0.2441	18.3 0.7205	60.3 2.3740	22.80	18.20	0.68 0.67 0.65
SA209-26 209-27 209-28 209	1-5/8 1-11/16 1-3/4	45	85 3.3465	19 0.7480	30.2 1.1890	43.6 1.7165	11 0.4331	6.4 0.2519	18.3 0.7205	63.5 2.5000	24.50	20.80	0.76 0.73 0.69 0.69
SA210-30 210-30 210	1-7/8 1-5/16	50	90 3.5433	20 0.7874	30.2 1.1890	43.6 1.7165	11 0.4331	6.5 0.2559	18.3 0.7205	69.9 2.7520	27.00	23.20	0.83 0.79 0.79
SA211-32 211-34 211 211-35	2 2-1/8 2-3/16	55	100 3.9370	23 0.9449	32.4 1.2756	48.4 1.9055	12 0.4724	7.0 0.2756	20.7 0.8150	76.2 3.0000	33.50	29.20	0.96 0.87 0.84 0.81
SA212-36 212 212-38 212-39	2-1/4 2-3/8 2-7/16	60	110 4.3307	24 0.9449	33.4 1.3150	53.1 2.0906	13.5 0.5315	7.6 0.2993	22.3 0.8780	84.2 3.315	36.80	32.80	1.30 1.20 1.09

Note: Suffix "G" - Relub.; Prefix "C" - Cylindrical O.D for North America

11 | Insert Ball Bearing Units

Insert Ball Bearings

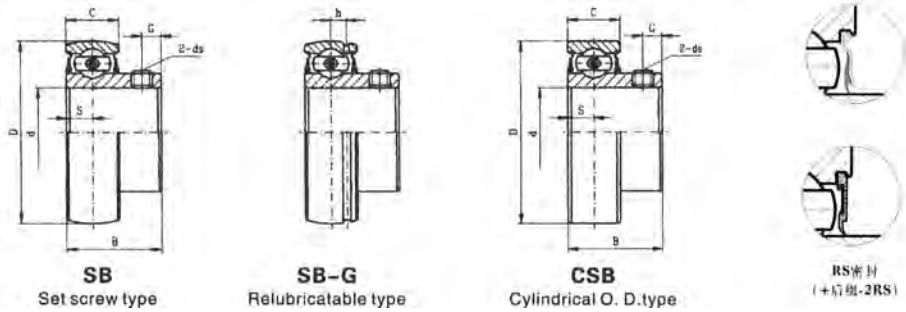

Bearing no.	Shaft Dia.		Dimensions(mm)/(in.)							Basic load rating (kN)		Weight (Kg)	
	d (in.)	d (mm)	D	B	C	S	h	G	ds	Dynamic Cr	Static Cr		
SB201 201-08 202 202-10 203 203-11	1/2	12								13.5 0.5315	7.35	4.78	1.10 0.09 0.10 0.08
		15	40	13	19.1	28.6	6.5	3.4					
	5/8	17	1.5748	0.5118	0.752	1.126	0.2559	0.1338					
	11/16												
SB204-12 204	3/4	20	47	25	14	7	3.7	5	M6X1 1/4-28UNF	9.88	6.65	0.15 0.13	
		25	1.8504	0.9843	0.5512	0.2756	0.1456	0.1969					
SB205-14 205-15 205 205-16	7/8		52	27	15	7.5	3.9	5.5	M6X1 1/4-28UNF	10.80	7.88	0.18 0.17 0.18 0.16	
	15/16	25	2.0473	1.0630	0.5906	0.2953	0.1535	0.2165					
SB206-18 206 206-19 206-20	1-1/8		62	30	16	8	5	6	M6X1 1/4-28UNF	15.00	11.20	0.28 0.26 0.25 0.24	
	1-3/16	30	2.4409	1.1811	0.6299	0.3150	0.1969	0.2362					
	1-1/4												
SB207-20 207-21 207-22 207 207-23	1-1/4		72	32	17	8.5	5.7	6	M6X1 1/4-28UNF	19.80	15.20	0.43 0.41 0.38 0.42 0.37	
	1-5/16												
	1-3/8	35	2.8346	1.2598	0.6693	0.3346	0.2244	0.2362					
SB208-24 208-25 208	1-1/2		80	34	18	9	6.2	7	M8X1 5/16- 24UNF	22.80	18.20	0.60 0.58 0.60	
	1-9/16	40	3.1496	1.3386	0.7087	0.3543	0.2441	0.2756					
SB209-26 209-27 209-28 209	1-5/8		85	41.2	19	10.2	6.4	8.2	M8X1 5/16- 24UNF	24.50	20.80	0.80	
	1-11/16	45	3.3465	1.6220	0.7480	0.4016	0.2519	0.3228					
SB210-30 210-31 210	1-7/8		90	43.5	20	10.9	6.5	9.2	M8X1 5/16- 24UNF	27.00	23.20	0.80	
	1-15/16	50	3.5433	1.7126	0.7874	0.4291	0.2559	0.3622					
SB211-32 211-34 211 211-35	2		100	45.3	23	11.8	7.0	9.8	M8X1 5/16- 24UNF	33.50	29.20	1.10	
	2-1/8	55	3.9370	1.7835	0.9055	0.4646	0.2756	0.3858					
	2-3/16												
SB212-36 212 212-39	2-1/4		110	53.7	24	14.9	7.6	9.8	M10X1.25 3/8-24UNF	36.80	32.80	1.30	
	2-7/16	60	4.3307	2.1142	0.9449	0.5866	0.2993	0.3898					

Note: Suffix "G" - Relub.; Prefix "C" - Cylindrical O.D for North America

Insert Ball Bearings

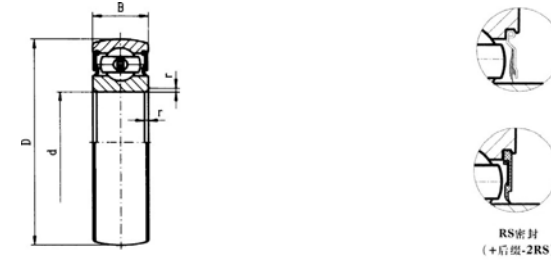

CS-2RS Series

Bearing no.	Dimensions(mm)/(in.)				Basic load rating (kN)		Weight (Kg)
	d	D	B	r(min)	Dynamic Cr	Static Cr	
CS201	12	32	10	0.6	6800	3050	0.039
CS202	15	35	11	0.6	7650	3720	0.039
CS203	17	40	12	0.6	9580	4780	0.050
CS204	20	47	14	1	12800	6650	0.095
CS205	25	52	15	1	14000	7880	0.110
CS305		62	17	1.1	22200	11500	0.200
CS206	30	62	16	1.1	19500	11500	0.180
CS306		72	19	1.5	27000	15200	0.300
CS207	35	72	17	1.1	25500	15200	0.250
CS307		80	21	1.5	33200	19200	0.400
CS208	40	80	18	1.1	29500	18000	0.320
CS308		90	23	1.5	40800	24000	0.550
CS209	45	85	19	1.1	31500	20800	0.370
CS309		100	25	1.5	52800	31500	0.730
CS210	50	90	20	1.1	35000	23200	0.410
CS310		110	27	2	61800	38000	0.950

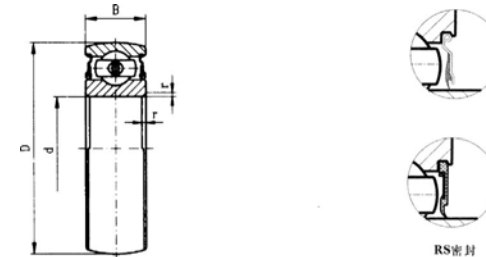

ORAE Series

Bearing no.	Dimensions(mm)/(in.)				Basic load rating (kN)		Weight (Kg)
	d	D	B	r(min)	Dynamic Cr	Static Cr	
ORAE30NPPB	30	62	18	1	19500	11500	0.210
ORAE40NPPB	40	80	22	1.1	29500	18200	0.380

11 | Insert Ball Bearing Units

Pillow Blocks

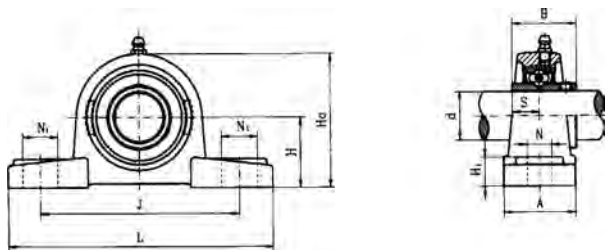

UCP Set screw type

Unit No.	Shaft Dia. d		Dimensions(mm)/(in.)							Dimensions(mm)/(in.)			Bolt Size	Bearing No.	Housing No.	Weight (Kg)	
	(in.)	(mm)	H	L	J	A	N	N ₁	H ₁	H ₀	S	B					
UCP202 202-10 203 203-11	5/8	15	30.2	125	96	32	13	19	13	57	11.5	27.4	M10	UC202 202-10 203 203-11	P203	0.6	
	11/16	17															
	3/4	20															
UCP204-12 204	7/8	25	33.3	127	96	37	13	19	14	63.8	12.7	31	M10	UC204-12 204	P204	0.65	
	15/16																20
	1																25
UCP205-14 205-15 205 205-16	1-1/8	30	42.9	160	121	44	17	21	16	82	15.9	38.1	M12	UC205-14 205-15 205 205-16	P205	0.72	
	1-3/16																30
	1-1/4																30
UCP206-18 206 206-19 206-20	1-1/4	35	47.6	167	127	45	17	21	17	92	17.5	42.9	M12	UC206-18 206 206-19 206-20	P206	1.15	
	1-5/16																35
	1-3/8																35
UCP207-20 207-21 207-22 207 207-23	1-1/2	50	49.2	180	137	52	17	21	18	98	19	49.2	M12	UC207-20 207-21 207-22 207 207-23	P207	1.53	
	1-9/16																50
	1-7/16																50
UCP208-24 208-25 208	1-5/8	45	54	189	146	54	17	21	20	105.5	19	49.2	M12	UC208-24 208-25 208	P208	1.88	
	1-11/16																45
	1-3/4																45
UCP209-26 209-27 209-28 209	1-7/8	50	57.2	204	159	59	20	25	21	112.2	19	51.6	M16	UC209-26 209-27 209-28 209	P209	2.1	
	1-15/16																50
	1-15/16																50
UCP210-30 210-31 210	2	55	63.5	217	171	57	20	25	22	124.5	22.2	55.6	M16	UC210-30 210-31 210	P210	2.5	
	2-1/8																55
	2-3/16																55
UCP211-32 211-34 211 211-35	2-1/4	60	69.9	238	184	66	20	24	24	137	25.4	65.1	M16	UC211-32 211-34 211 211-35	P211	3.3	
	2-3/8																60
	2-7/16																60
UCP212-36 212 212-38 212-39	2-1/2	65	76.2	262	203	68	25	30	26	149	25.4	65.1	M20	UC212-36 212 212-38 212-39	P212	5.5	
	2-3/4																65
	2-3/4																65
UCP213-40 213	2-3/4	70	79.4	266	210	69	25	31	27	155	30.2	74.6	M20	UC213-40 213	P213	5.6	
	2-3/4																70
	2-3/4																70
UCP214-44 214	3	75	82.6	274	217	73	25	29	28	161.6	33.3	77.8	M20	UC214-44 214	P214	6.6	
	3																75
	3																75
UCP215 215-48	80	80	88.9	292	232	76	25	30	30	174	33.3	82.6	M20	UC215 215-48	P215	7.3	
	80																80
	80																80
UCP216	3-1/4	85	95.2	310	247	83	25	28	32	186	34.1	85.7	M20	UC216	P216	8.3	
	3-1/4																85
	3-1/4																85
UCP217-52 217	3-1/2	90	101.6	326	262	87	27	32	33	198	39.7	96	M22	UC217-52 217	P217	10.8	
	3-1/2																90
	3-1/2																90
UCP218-56 218	3-1/2	90	101.6	326	262	87	27	32	33	198	39.7	96	M22	UC218-56 218	P218	13	
	3-1/2																90
	3-1/2																90

Note: Grease fittings cal locate at 45° position of housings front right side

11 | Insert Ball Bearing Units

Pillow Blocks

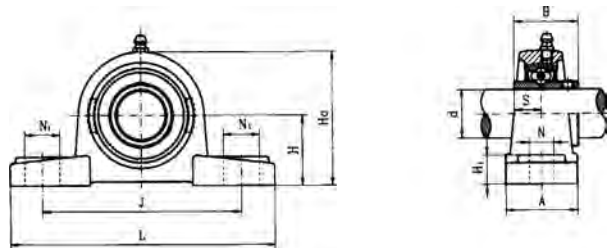

UCP Set screw type

Unit No.	Shaft Dia.		Dimensions(mm)/(in.)							Dimensions(mm)/(in.)			Bolt Size	Bearing No.	Housing No.	Weight (kg)
	d (in.)	d (mm)	H	L	J	A	N	N ₁	H ₁	H ₀	S	B				
UCP305-14 305-15 305-16	7/8 15/16 1	25	45	173	132	42	17	20	15	85	15	38	M14	UC305-14 305-15 305-16	P305	1.4
UCP306-18 306-19	1-1/8 1-3/16	30	50	180	140	50	17	20	15	95	17	43	M14	UC306-18 306-19	P306	1.8
UCP307-20 307-21 307-22 307	1-1/4 1-5/16 1-3/8	35	56	210	160	56	17	25	19	106	19	48	M14	UC307-20 307-21 307-22 307	P307	2.8
UCP308-24 308-25 308	1-1/2 1-9/16	40	60	218	170	62	18	25	10	116	19	52	M14	UC308-24 308-25 308	P308	3.0
UCP309-26 309-27 309-28 309	1-5/6 1-11/16 1-3/4	45	67	244	190	66	20	26	23	129	22	57	M16	UC309-26 309-27 309-28 309	P309	4.1
UCP310-30 310-31 310	1-7/8 1-15/16	50	75	271	212	74	20	30	26	143	22	61	M16	UC310-30 310-31 310	P310	5.8
UCP311-32 311-34 311 311-35	2 2-1/8 2-3/16	55	80	300	236	80	20	32	29	154	25	66	M16	UC311-32 311-34 311 311-35	P311	7.4
UCP312-36 312-38 312-39	2-1/4 2-3/8 2-7/16	60	85	325	250	85	23	35	31	164	26	71	M20	UC312-36 312-38 312-39	P312	9.4
UCP313-40 313	2-1/2	65	90	335	260	90	25	38	33	176	30	75	M20	UC313-40 313	P313	10
UCP314-44 314	2-3/4	70	95	360	280	93	27	40	34	187	31	78	M22	UC314-44 314	P314	12
UCP315 315-48	3	75	100	380	290	100	27	40	35	198	32	82	M22	UC315 315-48	P315	14
UCP316		80	106	400	300	105	27	40	37	210	34	86	M22	UC316	P316	18
UCP317-52 317	3-1/4	85	112	420	320	110	33	45	40	220	40	96	M27	UC317-52 317	P317	20
UCP318-56 318	3-1/2	90	118	430	330	110	33	45	40	234	40	96	M27	UC318-56 318	P318	24
UCP319 319-60	3-3/4	95	125	470	360	120	36	50	46	248	41	103	M30	UC319 319-60	P319	29
UCP320 320-64	4	100	140	490	380	120	36	50	50	275	42	108	M30	UC 320 320-64	P320	35
UCP321		105	140	490	380	120	36	50	56	283	44	112	M18x1.5	UC321	P321	35
UCP322		110	150	520	400	140	40	55	61	303	46	117	M18x1.5	UC322	P322	45
UCP324		120	160	570	450	140	40	55	71	323	51	126	M18x1.5	UC324	P324	55
UCP326		130	180	600	480	140	40	55	81	363	54	135	M20x1.5	UC326	P326	72
UCP328		140	200	620	500	140	40	55	81	403	59	145	M20x1.5	UC328	P328	89

Note: Grease fittings cal locate at 45° position of housings front right side

11 | Insert Ball Bearing Units

Pillow Blocks

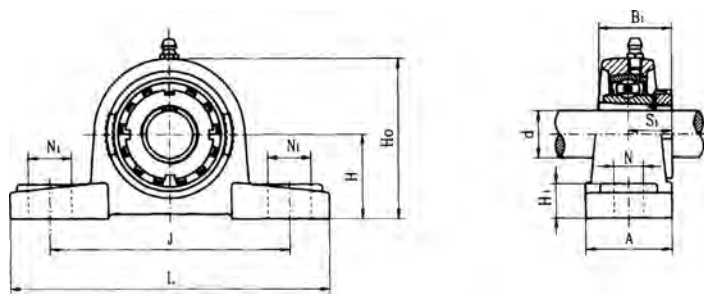

UKP + H Tapered bore, adapter type

Unit No.	Shaft Dia. d		Dimensions(mm)/(in.)							Dimensions(mm)/(in.)			Bolt Size	Bearing No.	Housing No.	Adapter No.	Weight (kg)	Available	
	(in.)	(mm)	H	L	J	A	N	N ₁	H ₁	H _o	S ₁	B ₁						N	N ₁
UKP205+HE2305 205+H2305	3/4	20	36.5	140	105	38	13	19	15	69.5	18.5	35	M10	UK205	P205	HE 2305 H2305	.83	--	--
UKP206+HS2306 206+HA2306 206+H2306 206+HE2306	7/8 15/16 1	25	42.9	160	121	43	17	21	16	82	20.5	38	M12	UK206	P206	HS 2306 HA 2306 H 2306 HE 2306	1.3	17	21
UKP207+HS2307 207+H2307 207+HA2307	1-1/8 1-3/16	30	47.6	167	126	45	17	21	17	92	22.5	43	M12	UK207	P207	HS 2307 H 2307 HA 2307	1.5	17	21
UKP208+HE2308 208+HS2308 208+H2308	1-1/4 1-3/8	35	49.2	180	136	52	17	21	18	98	24.5	46	M12	UK208	P208	HE 2308 HS 2308 H 2308	2.0	17	23
UKP209+HA2309 209+HA2309 209+H2309	1-7/16 1-1/2	40	54	189	146	54	17	21	20	105.5	26	50	M12	UK209	P209	HA 2309 HE 2309 H 2309	2.3	17	23
UKP210+HS2310 210+HA2310 210+H2310 210+HE2310	1-5/8 1-11/16 1-3/4	45	57.2	204	159	59	20	25	21	112.2	27.5	55	M16	UK210	P210	HS 2310 HA 2310 HE 2310 H 2310	3.0	--	--
UKP211+HS2311 211+HA2311 211+H2311 211+HE2311	1-7/8 1-15/16 2	50	63.5	217	172	57	20	25	22	124.5	28.5	59	M16	UK211	P211	HS 2311 HA 2311 H 2311 HE 2311	3.5	--	--
UKP212+HS2312 212+H2312	2-1/8	55	69.9	238	186	66	20	24	24	137	31	62	M16	UK212	P212	HS 2312 HS 2312	4.7	--	--
UKP213+HA2313 213+HE2313 213+H2313 213+HS2313	2-3/16 2-1/4 2-3/8	60	76.2	262	203	68	25	30	26	149	32	65	M20	UK213	P213	HA 2313 HE 2313 H2313 HS 2313	5.9	25	29
UKP215+HA2315 215+HE2315 215+H2315	2-7/16 2-1/2	65	82.6	274	217	73	25	30	28	161.6	35.5	72	M20	UK215	P215	HA 2315 HE 2315 H2315	7.6	--	--
UKP216+HA2316 216+HE2316 216+H2316	2-11/16 2-3/4	70	88.9	292	232	76	25	35	30	174	39	78	M20	UK216	P216	HA 2316 HE 2316 H2316	9.2	--	--
UKP217+H2317		75	95.2	310	247	83	25	28	32	186	40	82	M20	UK217	P217	H 2317		--	--
UKP218+H2318		80	101.6	326	262	88	27	34	33	198	42	86	M22	UK218	P218	H 2318		23	37

Note: Grease fittings cal locate at 45° position of housings front right side

11 | Insert Ball Bearing Units

Pillow Blocks

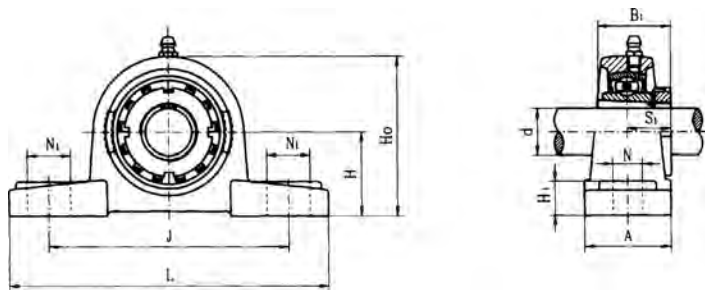

UKP + H Tapered bore, adapter type

Unit No.	Shaft Dia. d		Dimensions(mm)/(in.)							Dimensions(mm)/(in.)			Bolt Size	Bearing No.	Housing No.	Adapter No.	Weight (Kg)
	(in.)	(mm)	H	L	J	A	N	N ₁	H ₁	H _o	S ₁	B ₁					
UKP305+HE2305 305+H2305	3/4	20	45	173	132	45	17	20	15	85	21.5	35	M14	UK305	P305	HE2306 H2305	1.4
UKP306+HS2306 306+HA2306 306+H2306 306+HE2306	7/8 15/16 1	25	50	180	140	50	17	20	15	95	23	38	M14	UK306	P306	HS2306 HA2306 H2306 HE2306	1.8
UKP307+HS2307 307+H2307 307+HA2307	1-1/8 1-3/16	30	56	210	160	56	17	25	19	106	25.5	43	M14	UK307	P307	HS2307 H2307 HA2307	2.9
UKP308+HE2308 308+HS2308 308+H2308	1-1/4 1-3/16	35	60	218	170	62	18	25	19	116	27.5	46	M14	UK308	P308	HE2308 HS2308 H2308	3.1
UKP309+HA2309 309+HE2309 309+H2309	1-7/16 1-1/2	40	67	244	190	66	20	26	23	129	30	50	M15	UK309	P309	HA2309 HE2309 H2309	4.2
UKP310+HS 2310 310+HA2310 310+HE2310 310+H2310	1-5/8 1-11/16 1-3/4	45	75	271	212	74	20	30	26	143	32	55	M16	UK310	P310	HS2310 HA2310 HE2310 H2310	5.8
UKP311+HS2311 311+HA2311 311+H2311 311+HE2311	1-7/8 1-11/16 2	50	80	300	236	80	20	32	29	154	33.5	59	M16	UK311	P311	HS2311 HA2311 H2311 HE2311	7.4
UKP312+HS2312 312+H2312	2-1/8	55	85	325	250	85	23	35	31	164	36.5	62	M20	UK312	P312	HS2312 H2312	9.3
UKP313+HA2313 313+HE2313 313+H2313 313+HS2313	2-3/16 2-1/4 2-3/8	60	90	335	260	90	25	38	33	176	38.5	65	M20	UK313	P313	HA2313 HE2313 H2313 HS2313	10

Note: Grease fittings cal locate at 45° position of housings front right side

11 | Insert Ball Bearing Units

Pillow Blocks

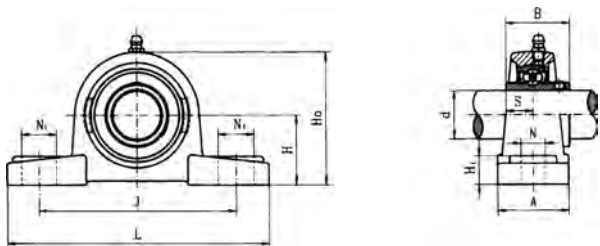

UCAK

Unit No.	Shaft Dia.		Dimensions(mm)							Dimensions (mm)		Bolt Size	Bearing No.	Housing No.	Weight (Kg)
	(in.)	d (mm)	DA	H	L	J	A	H ₀	N	N ₁	H ₁				
UCAK201		12	40	27	120	89	35	54	13	16	13	M10	UC201	AK201	0.73
UCAK202		15	40	27	120	89	35	54	13	16	13	M10	UC202	AK202	0.74
UCAK203		17	40	27	120	89	35	54	13	16	13	M10	UC203	AK203	0.73
UCAK204		20	47	31.8	133	98	41	63	13	16	14.3	M10	UC204	AK204	0.77
UCAK205		25	52	33.3	140	105	45	68	13	16	16	M10	UC205	AK205	0.93
UCAK206		30	62	39.7	160	121	48	80	15	16	17	M12	UC206	AK206	1.28
UCAK207		35	72	46	167	127	48	92	15	19	19	M12	UC207	AK207	1.6
UCAK208		40	80	49.2	181	140	54	100	15	19	19	M12	UC208	AK208	2.07
UCAK209		45	85	52.4	190	146	54	106	15	19	21	M12	UC209	AK209	2.33
UCAK210		50	90	55.6	203	159	57	113	15	19	22	M16	UC210	AK210	2.7
UCAK211		55	100	61.9	232	181	60	125	20	24	25	M16	UC211	AK211	3.67
UCAK212		60	110	68.3	241	190	64	136	20	24	29	M16	UC212	AK212	4.63
UCAK213		65	120	68.3	248	194	70	141	20	29	27	M20	UC213	AK213	6.42
UCAK214		70	125	82.6	294	232	72	160	20	32	29	M20	UC214	AK214	7.18
UCAK215		75	130	84.1	304	241	74	165	22	32	32	M20	UC215	AK215	8.86

Note: Grease fittings can locate at 45° position of housings front right side

11 | Insert Ball Bearing Units

Pillow Blocks

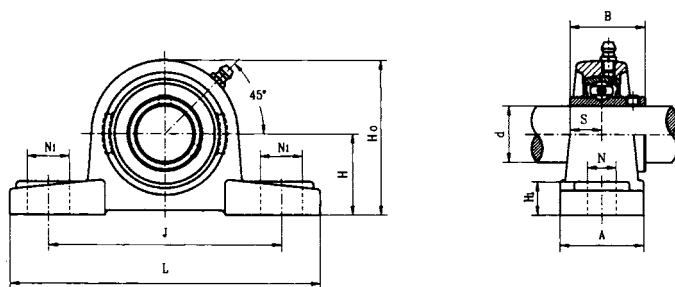

UCPK Set screw type

Unit No.	Shaft Dia. d		Dimensions(mm)							Dimensions(mm)			Bolt Size	Bearing No.	Housing No.	Weight (Kg)
	(in.)	(mm)	H	L	J	A	N	N ₁	H ₁	H ₀	S	B				
UCPK202 202-10 203 203-11	5/8	15	27	121	89	35	11	14	13	54	11.5	27.4	M10	UC202 202-10 203 203-11	PK 203	0.6
	11/16	17														
UCPK204-12 204	3/4	20	31.8	128	98	38	11	14	14	63	12.7	31	M10	UC204-12 204	PK 204	0.65
UCPK205-14 205-15 205 205-16	7/8	25	33.3	140	105	40	11	14	15	66.5	14.3	34.1	M10	UC205-14 205-15 205 205-16	PK 205	0.72
	15/16															
UCPK206-18 206 206-19 206-20	1-1/8	30	39.7	160	121	44	14	19	17	79	15.9	38.1	M12	UC206-18 206 206-19 206-20	PK 206	1.1
	1-3/16															
UCPK207-20 207-21 207-22 207 207-23	1-1/4	35	46	167	127	48	14	19	18	91	17.5	42.9	M12	UC207-20 207-21 207-22 207 207-23	PK 207	1.48
	1-5/16															
UCPK208-24 208-25 208	1-1/2	40	49.2	181	140	52	14	19	19	98	19	49.2	M12	UC208-24 208-25 208	PK 208	1.88
	1-9/16															
UCPK209-26 209-27 209-28 209	1-5/8	45	52.4	189	146	54	14	19	20	105	19	51.6	M12	UC209-26 209-27 209-28 209	PK 209	2.1
	1-11/16															
UCPK210-30 210-31 210	1-7/8	50	55.6	203	159	57	14	19	21	111.5	19	55.6	M12	UC210-30 210-31 210	PK 210	2.6
	1-15/16															
UCPK211-32 211-34 211 211-35	2	55	61.9	232	181	60	18	24	23	123	22.2	65.1	M16	UC211-32 211-34 211 211-35	PK 211	3.3
	2-1/8															
UCPK212-36 212 212-38 212-39	2-1/4	60	68.3	241	191	64	18	24	25	136	25.4	65.1	M16	UC212-36 212 212-38 212-39	PK 212	4.5
	2-3/8															
UCPK212-40 213	2-1/2	65	68.3	248	194	70	18	24	27	141	25.4	65.1	M16	UC212-40 213	PK 203	5.6

11 | Insert Ball Bearing Units

Pillow Blocks

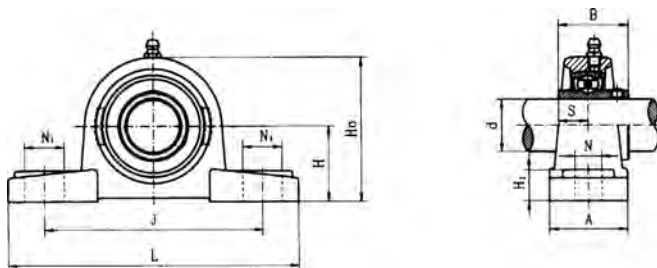

UCPX Set screw type

Unit No.	Shaft Dia. d		Dimensions(mm)							Dimensions(mm)			Bolt Size	Bearing No.	Housing No.	Weight (Kg)
	(in.)	(mm)	H	L	J	A	N	N ₁	H ₁	H _o	S	B				
UCPX05 - 14 X05 - 15 X05 - 16	7/8 15/16 1	25	44.4	159	119	51	17	20	17	85	15.9	38.1	M14	UCX05-14 X05-15 X05-16	PX 05	1.5
UCPX06-18 X06 - 19 X06 - 20	1-1/8 1-3/16 1-1/4	30	47.6	175	127	54	17	20	20	93	17.5	42.9	M14	UCX06-18 X06 - 19 X06 - 20	PX 06	2.1
UCPX07 - 22 X07 - 23	1-3/8 1-7/16	35	54	203	144	57	17	20	21	105	19	49.2	M14	UCX07 - 22 X07 - 23	PX 07	2.7
UCP X08 - 24 X08	1-1/2	40	58.7	222	156	65	20	23	23	112	19	49.2	M16	UCX08 - 24 X08	PX 08	3.5
UCPX09 - 26 X09 - 27 X09 - 28 X09	1-5/8 1-11/16 1-3/4	45	58.7	222	156	67	20	23	25	116	19	51.6	M16	UCX09 - 26 X09 - 27 X09 - 28 X09	PX 08	3.7
UCPX10 - 30 X10 - 31 X10 - 32	1-7/8 1-15/16 2	50	63.5	240	171	71	20	23	24	126	22.2	55.6	M16	UCX10 - 30 X10 - 31 X10 - 32	PX 10	4.6
UCPX11 - 34 X11 - 35 X11 - 36	2-1/8 2-3/16 2	55	69.8	260	184	79	25	28	29	137	25.4	65.1	M20	UCX11 - 34 X11 - 35 X11 - 36	PX 11	6.5
UCPX12 X12 - 38 X12 - 39	2-3/8 2-7/16	60	76.2	280	203	81	25	28	31	149	25.4	65.1	M20	UCX12 X12 - 38 X12 - 39	PX 12	7.7
UCPX13 - 40 X13	2-1/2	65	76.2	286	203	83	25	28	33	152	30.2	74.6	M20	UCX13 - 40 X13	PX 13	8.1
UCPX14 - 44 X14	2-3/4	70	88.9	320	229	85	27	30	34	170	33.3	77.8	M22	UCX14 - 44 X14	PX 14	10.2
UCPX15 X15 - 48	3	75	88.9	330	229	92	27	30	35	175	33.3	82.6	M22	UCX15 X15 - 48	PX 15	10.8
UCPX16		80	101.6	378	283	99	27	30	37	194	34.1	85.7	M22	UCX16	PX 16	15.3
UCPX17 - 52 X17	3-1/4	85	101.6	380	283	108	27	30	40	200	39.7	96	M22	UCX17 - 52 X17	PX 17	16.1
UCPX18 - 56 X18	3-1/2	90	101.6	381	283	106	27	30	40	206	42.9	104	M22	UCX18 - 56 X18	PX 18	19.1
UCPX20 X20 - 64	4	100	127	432	337	120	33	36	45	244	49.2	117.5	M27	UCX20 X20 - 64	PX 20	30.4

Note: Grease fittings cal locate at 45° position of housings front right side

11 | Insert Ball Bearing Units

High Center Height Pillow Blocks

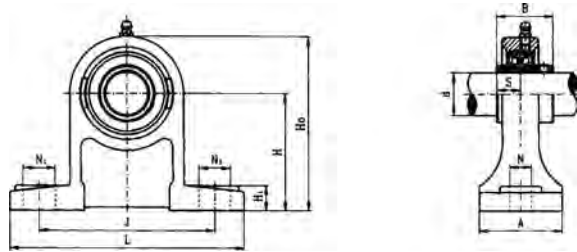

UCPH Set screw type

Unit No.	Shaft Dia. d		Dimensions(mm)/(in.)							Dimensions(mm)/(in.)			Bolt Size	Bearing No.	Housing No.	Weight (kg)
	(in.)	(mm)	H	L	J	A	N	N ₁	H ₁	H ₀	S	B				
UCPH202 202-10 203 UCPH203-11 UCPH204-12 204	5/8	15	70	95	127	40	12	16	13	101	12.7	31	M10	UC202 202-10 203 UC203-11 UC204-12 204	PH 203 PH204	0.78 0.80 0.94
	11/16	17														
	3/4	20														
UCPH205-14 205-15 205 UCPH205-16	7/8	25	80	105	140	50	13	19	16	114	14.3	34.1	M10	UC205-14 205-15 205 UC205-16	PH 205	1.20
	15/16															
	1															
UCPH206-18 206 UCPH206-19 206-20	1-1/8	30	90	121	165	50	17	21	18	130	15.9	38.1	M12	UC206-18 206 UC206-19 206-20	PH 206	1.60
	1-3/16															
	1-1/4															
UCPH207-20 207-21 207-22 207 UCPH207-23	1-1/4	35	95	127	167	60	17	21	19	140	17.5	42.9	M12	UC207-20 207-21 207-22 207 UC207-23	PH 207	2.10
	1-5/16															
	1-3/8															
UCPH208-25 208-24 208	1-1/2	40	100	137	184	66	17	21	20	150	19	49.2	M12	UC208-25 208-24 208	PH 208	2.70
	1-9/16															
UCPH209-26 209-27 209-28 209	1-5/8	45	105	146	190	70	17	21	20	158	19	49.2	M12	UC209-26 209-27 209-28 209	PH 209	3.10
	1-11/16															
	1-3/4															
UCPH210-30 210-31 210 UCPH210-32	1-7/8	50	110	159	204	70	19	22	22	165	19	51.6	M16	UC210-30 210-31 210 UC210-32	PH 210	3.50
	1-15/16															
	2															
UCPH211-32 211-34 211 UCPH211-35	2	55	120	171	217	75	19	22	23	181	22.2	55.6	M16	UC211-32 211-34 211 UC211-35	PH 211	4.07
	2-1/8															
	2-3/16															
UCPH212-36 212 UCPH212-38 212-39	2-1/4	60	130	186	236	80	19	22	24	197	25.4	65.1	M16	UC212-36 212 UC212-38 212-39	PH 212	
	2-3/8															
	2-7/16															
UCPH213-40 213	2-1/2	65	140	203	258	85	23	28	26	213	25.4	65.1	M20	UC213-40 213	PH 213	
UCPH214-44 214	2-3/4	70	150	210	266	90	23	28	27	227	30.2	74.6	M20	UC214-44 214	PH 214	
UCPH215-47 215 UCPH215-48	2-15/16	75	160	217	274	95	23	28	28	240	33.3	77.8	M20	UC215-47 215 UC215-48	PH 215	
	3															
UCPH216		80	170	232	290	100	24	28	30	256	33.3	82.6	M20	UC216	PH 216	

11 | Insert Ball Bearing Units

Tapped - Based Pillow Blocks

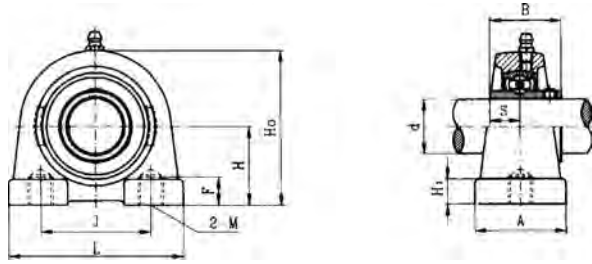

UCPA Set screw type

Unit No.	Shaft Dia.		Dimensions(mm)							Dimensions(mm)			Bearing No.	Housing No.	Weight (kg)
	d (in.)	d (mm)	H	L	J	A	H ₀	H ₁	S	B	F	M			
UCPA202 202-10 203 203-11 UCPA204-12 204	5/8 11/16 3/4	15 17 20	30.2	76	52	40	62	12	12.7	31	13	M10X1.5	UC202 202-10 203 203-11 UC204-12 204	PA 203 PA 204	0.6
UCPA205-14 205-15 205 205-16	7/8 15/16 1	25	36.5	84	56	38	72	12	14.3	34.1	15	M10X1.5	UC205-14 205-15 205 205-16	PA 205	0.8
UCPA206-18 206 206-19 206-20	1-1/8 1-3/16 1-1/4	30	42.9	94	66	48	84	12	15.9	38.1	18	M14X2	UC206-18 206 206-19 206-20	PA 206	1.2
UCPA207-20 207-21 207-22 207 207-23	1-1/4 1-5/16 1-3/8 1-7/16	35	47.6	110	80	48	95	12	17.5	42.9	20	M14X2	UC207-20 207-21 207-22 207 207-23	PA 207	1.7
UCPA208-25 208-24 208	1-1/2 1-9/16	40	49.2	116	84	54	100	12	19	49.2	20	M14X2	UC208-25 208-24 208	PA 208	2.0
UCPA209-26 209-27 209-28 209	1-5/8 1-11/16 1-3/4	45	54.2	120	90	60	108	12	19	49.2	25	M14X2	UC209-26 209-27 209-28 209	PA 209	2.2
UCPA210-30 210-31 210 210-32	1-7/8 1-15/16 2	50	57.2	130	94	60	116	12	19	51.6	25	M16X2	UC210-30 210-31 210 210-32	PA 210	2.8
UCPA211-32 211-34 211 211-35	2 2-1/8 2-3/16	55	63.5	140	104	66	125	12	22.2	55.6	25	M16X2	UC211-32 211-34 211 211-35	PA 211	3.0
UCPA212-36 212 212-38 212-39	2-1/4 2-3/8 2-7/16	60	69.9	150	114	68	138	12	25.4	65.1	25	M16X2	UC212-36 212 212-38 212-39	PA 212	4.24
UCPH212-40 213	2-1/2	65	76.2	160	124	70	150	12	25.4	65.1	25	M16X2	UC212-40 213	PA 213	--

Note: Grease fittings cal locate at 45° position of housings front right side

11 | Insert Ball Bearing Units

Square Flange Units

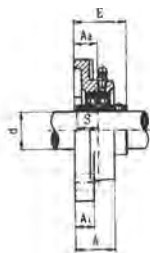
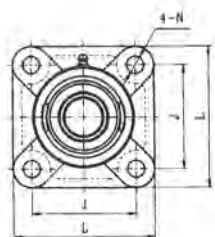

UCF Set screw type

Unit No.	Shaft Dia. d		Dimensions(mm)								Bolt Size	Bearing No.	Housing No.	Weight (kg)
	(in.)	(mm)	L	J	A ₂	A ₁	A	E	N	S				
UCF202 202-10 203 203-11	5/8	15	76	54	15	11	25.5	30.9	12	11.5	M10	UC202 202-10 203 203-11	F203	0.57
	11/16	17												0.50
UCF204-13 204	3/4	20	86	64	15	11	25.5	33.3	12	12.7	M10	UC204-13 204	F204	0.61
UCF205-14 205-15 205 205-16	7/8	25	95	70	16	13	27	35.8	12	14.3	M10	UC205-14 205-15 205 205-16	F205	0.80
	15/16													1
UCF206-18 206 206-19 206-20	1-1/8	30	108	83	18	13	31	40.2	12	15.9	M10	UC206-18 206 206-19 206-20	F206	1.07
	1-3/16													1-1/4
UCF207-20 207-21 207-22 207 207-23	1-1/4	35	117	92	19	15	34	44.4	14	17.5	M12	UC207-20 207-21 207-22 207 207-23	F207	1.40
	1-5/16													1-3/8
UCF208-24 208-25 208	1-1/2	40	130	102	21	15	36	51.2	16	19	M12	UC208-24 208-25 208	F208	1.80
	1-9/16													
UCF209-26 209-27 209-28 209	1-5/8	45	137	105	22	16	38	52.2	16	19	M14	UC209-26 209-27 209-28 209	F209	2.20
	1-11/16													1-3/4
UCF210-30 210-31 210	1-7/8	50	143	111	22	16	40	54.6	16	19	M16	UC210-30 210-31 210	F210	2.40
	1-15/16													
UCF211-32 211 211-34 211-35	2	55	162	130	25	18	43	58.4	19	22.2	M16	UC211-32 211 211-34 211-35	F211	3.50
	2-1/8													
UCF212-36 212 212-38 212-39	2-1/4	60	175	143	29	18	48	68.7	19	22.2	M16	UC212-36 212 212-38 212-39	F212	4.20
	2-3/8													2-7/16
UCF213-40 213	2-1/2	65	187	149	30	22	50	69.7	19	25.4	M16	UC213-40 213	F213	5.30
UCF214-44 214	2-3/4	70	193	152	31	22	54	75.4	19	25.4	M16	UC214-44 214	F214	5.90
UCF215-47 215 215-48	2-15/16	75	200	159	34	22	56	78.5	19	30.2	M16	UC215-47 215 215-48	F215	6.30
	3													
UCF216		80	208	165	34	22	57	83.3	23	33.3	M20	UC216	F216	7.30
UCF217-52 217	3-1/4	85	220	175	36	24	63	87.6	23	34.1	M20	UC217-52 217	F217	8.90
UCF218-56 218	3-1/2	90	235	187	40	25	68	96.3	23	39.7	M20	UC218-56 218	F218	11.60

Note: Grease fittings cal locate at 45° position of housings front right side

11 | Insert Ball Bearing Units

Square Flange Units

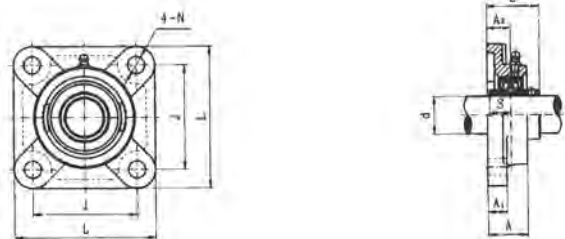

UCF Set screw type

Unit No.	Shaft Dia.		Dimensions(mm)								Bolt Size	Bearing No.	Housing No	Weight (kg)
	d (in.)	d (mm)	L	J	A ₂	A ₁	A	E	N	S				
UCF305-14 305-15 305 305-16	7/8 15/16 1	25	108	80	16	13	29	39	16	15	M 14	UC305-14 305-15 305 305-16	F305	1.2
UCF306-18 306 306-19	1-1/8 1-3/16	30	125	95	18	15	32	44	16	17	M 14	UC306-18 306 306-19	F306	1.8
UCF307-20 307-21 307-22 307	1-1/4 1-5/16 1-3/8	35	135	100	20	16	36	49	19	19	M 16	UC307-20 307-21 307-22 307	F307	2.2
UCF308-24 308-25 308	1-1/2 1-9/16	40	150	112	23	17	40	56	19	19	M 16	UC308-24 308-25 308	F308	2.9
UCF309-26 309-27 309-28 309	1-5/8 1-11/16 1-3/4	45	160	125	25	18	44	60	19	22	M 16	UC309-26 309-27 309-28 309	F309	3.5
UCF310-30 310-31 310	1-7/8 1-15/16	50	175	132	28	20	48	67	23	22	M 20	UC310-30 310-31 310	F310	4.8
UCF311-32 311-34 311 311-35	2 2-1/8 2-3/16	55	185	140	30	20	52	71	23	25	M 20	UC311-32 311-34 311 311-35	F311	5.6
UCF312-36 312 312-38 312-39	2-1/4 2-3/8 2-7/16	60	193	150	33	22	56	78	23	26	M 20	UC312-36 312 312-38 312-39	F312	6.7
UCF313-40 313	2-1/2	65	208	166	33	22	58	78	23	30	M 20	UC313-40 313	F313	7.8
UCF314-44 314	2-3/4	70	226	178	36	25	61	81	25	33	M 22	UC314-44 314	F314	10.1
UCF315 315-48	3	75	236	184	39	25	66	89	25	32	M 22	UC315 315-48	F315	11.1
UCF316		80	250	196	38	27	68	90	31	34	M 27	UC316	F316	12.8
UCF317-52 317	3-1/4	85	260	204	44	27	74	100	31	40	M 27	UC317-52 317	F317	15.4
UCF318-56 318	3-1/2	90	280	216	44	30	75	100	35	40	M 30	UC318-56 318	F318	19.0
UCF319 319-60	3-3/4	95	290	228	59	30	94	121	35	41	M 30	UC319 319-60	F319	20.6
UCF320 320-64	4	100	310	242	59	32	94	125	38	42	M 33	UC320 320-64	F320	25.7
UCF321		105	310	242	59	32	94	127	38	44	M 33	UC321	F321	
UCF322		110	340	266	60	35	96	131	41	46	M 36	UC322	F322	
UCF324		120	370	290	65	40	110	140	41	51	M 36	UC324	F323	
UCF326		130	410	320	65	45	115	146	41	54	M 36	UC326	F324	
UCF328		140	450	350	75	55	125	161	41	59	M 36	UC328	F3025	

11 | Insert Ball Bearing Units

Square Flange Units

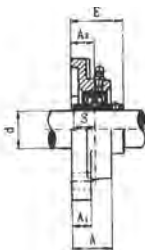
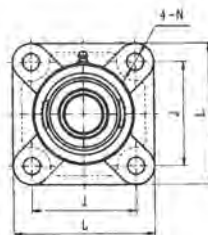

UKF + H Set screw type

Unit No.	Shaft Dia.		Dimensions(mm)								Bolt Size	Bearing No.	Housing No	Adapter No.	Weight (kg)
	d (in.)	d (mm)	L	J	A ₂	A ₁	A	E	N	S ₁					
UKF 305+HE2305 305+H2305	3/4	20	108	80	16	13	29	37.5	16	21.5	M14	UK305	F305	HE2305 H2305	1.2
UKF 306+HS2306 306+HA2306 306+H2306 306+HE2306	7/8 15/16 1	25	125	95	18	15	32	41	16	23	M14	UK306	F306	HS2306 HA2306 H2306 HE2306	1.8
UKF 307+HE2307 307+H2307 307+HA2307	1-1/8 1-3/16	30	135	100	20	16	36	45.5	19	25.5	M16	UK307	F307	HE2307 H2307 HA2307	2.2
UKF 308+HE2308 308+HS2308 308+H2308	1-1/4 1-3/4	35	150	112	23	17	40	50.5	19	27.5	M16	UK308	F308	HE2308 HS2308 H2308	2.9
UKF 309+HA2309 309+HE2309 309+H2309	1-7/16 1-1/2	40	160	125	25	18	44	55	19	30	M16	UK309	F309	HA2309 HE2309 H2309	3.5
UKF 310+HS2310 310+HA2310 310+HE2310 310+H2310	1-5/8 1-11/16 1-3/4	45	175	132	28	20	48	60	23	32	M20	UK310	F310	HS2310 HA2310 HE2310 H2310	4.8
UKF 311+HS2311 311+HA2311 311+H2311 311+HE2311	1-7/8 1-15/16 2	50	185	140	30	20	52	63.5	23	33.5	M20	UK311	F311	HS2311 HA2311 H2311 HE2311	5.6
UKF 312+HS2312 312+H2312	2/1-8	55	193	150	33	22	56	69.5	23	36.5	M20	UK312	F312	HS2312 H2312	6.7
UKF 313+HA2313 313+HE2313 313+H2313 313+HS2313	2-3/16 2-1/4 2-3/8	60	208	166	32	22	58	71.5	23	38.5	M20	UK313	F313	HA2313 HE2313 H2313 HS2313	7.8

11 | Insert Ball Bearing Units

Oval Flange Units

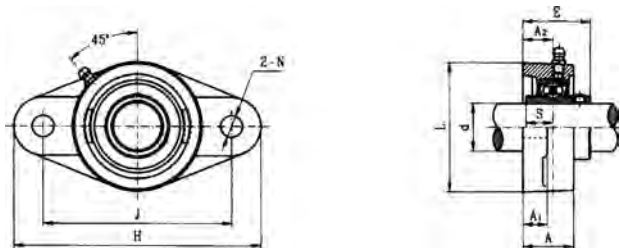

UCFL Set screw type

Unit No.	Shaft Dia.		Dimensions(mm)									Bolt Size	Bearing No.	Housing No	Weight (kg)
	d (in.)	d (mm)	H	J	L	A ₂	A ₁	A	E	N	S				
UCFL202 202-10 UCFL203 203-11	5/8 11/16	15 17	99	76.5	57	15	11	25.5	30.9	11.5	11.5	M10	UC202 202-10 UC203 203-11	FL203	0.45 0.43
UCFL204-12 204	3/4	20	113	90	60	15	11	25.5	33.3	12	12.7	M10	UC204-12 204	FL204	0.48
UCFL205-14 205-15 205 205-16	7/8 15/16 1	25	130	99	68	16	13	27	35.8	16	14.3	M10	UC205-14 205-15 205 205-16	FL205	0.6
UCFL206-18 206 206-19 206-206	1-1/8 1-3/16 1-1/4	30	148	117	80	18	13	31	40.2	16	15.9	M10	UC206-18 206 206-19 206-206	FL206	0.9
UCFL207-20 207-21 207 207-23	1-1/4 1-5/16 1-7/16	35	161	130	90	19	14	34	44.4	16	17.5	M12	UC207-20 207-21 207 207-23	FL207	1.2
UCFL208-24 208-25 208	1-1/2 1-9/16	40	175	144	100	21	14	36	51.2	16	19	M12	UC208-24 208-25 208	FL208	1.5
UCFL209-26 209-27 209-28 209	1-5/8 1-11/16 1-3/4	45	188	148	108	22	16	38	52.2	19	19	M16	UC209-26 209-27 209-28 209	FL209	1.9
UCFL210-30 210-31 210 210-32	1-7/8 1-15/16 2	50	197	157	115	22	16	40	54.6	19	19	M16	UC210-30 210-31 210 210-32	FL210	2.2
UCFL211-32 211-34 211 211-35	2 2-1/8 2-3/16	55	224	184	130	25	18	43	58.4	19	22.2	M16	UC211-32 211-34 211 211-35	FL211	3.1
UCFL212-36 212 212-38 212-39	2-1/4 2-3/8 3-7/16	60	250	202	140	29	18	48	68.7	23	25.4	M16	UC212-36 212 212-38 212-39	FL212	4.0
UCFL213-40 213	2-1/2	65	258	210	155	30	20	50	69.7	23	25.4	M20	UC213-40 213	FL213	5.0
UCFL214-44 214	2-3/4	70	265	216	160	31	20	54	75.4	23	30.2	M20	UC214-44 214	FL214	5.6
UCFL215-47 215 215-48	2-15/16 3	75	275	225	164	34	22	55	78.5	23	33.3	M20	UC215-47 215 215-48	FL215	6.2
UCFL216		80	290	233	180	34	22	58	83.3	25	33.3	M22	UC216	FL216	7.8
UCFL217-52 217	3-1/4	85	305	248	190	36	22	63	87.6	25	34.1	M22	UC217-52 217	FL217	9.8
UCFL218-56 218	3-1/2	90	320	265	205	40	23	68	96.3	25	39.7	M22	UC218-56 218	FL218	12.4

11 | Insert Ball Bearing Units

Oval Flange Units

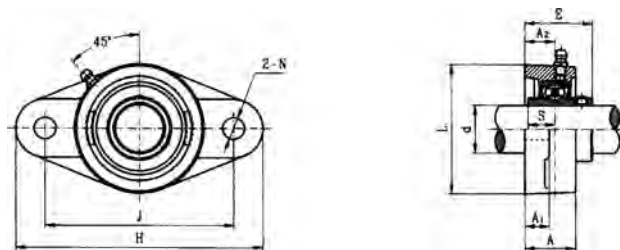

UCFL Set screw type

Unit No.	Shaft Dia.		Dimensions(mm)/(in.)									Bolt Size	Bearing No.	Housing No	Weight (kg)
	(in.)	(mm)	H	J	L	A ₂	A ₁	A	E	N	S				
UCFL305-14 305-15 305 305-16	7/8 15/16 1	25	150	113	80	16	13	29	39	19	15	M16	UC305-14 305-15 305 305-16	FL305	1.1
UCFL306-18 306 306-19	1-1/8 1-3/16	30	180	134	90	18	15	32	44	23	17	M20	UC306-18 306 306-19	FL306	1.5
UCFL307-20 307-21 307-22 307	1-1/4 1-5/16 1-3/8	35	185	141	100	20	16	36	49	23	19	M20	UC307-20 307-21 307-22 307	FL307	1.8
UCFL308-24 308-25 308	1-1/2 1-9/16	40	200	158	112	23	17	40	56	23	19	M20	UC308-24 308-25 308	FL308	2.5
UCFL309-26 309-27 309-28 309	1-5/8 1-11/16 1-3/4	45	230	177	125	25	18	44	60	25	22	M22	UC309-26 309-27 309-28 309	FL309	3.4
UCFL310-30 310-31 310	1-7/8 1-15/16	50	240	187	140	28	19	48	67	25	22	M22	UC310-30 310-31 310	FL310	4.4
UCFL311-32 311-34 311 311-35	2 2-1/8 2-3/16	55	250	198	150	30	20	52	71	25	25	M22	UC311-32 311-34 311 311-35	FL311	5.1
UCFL312-36 312 312-38 312-39	2-1/4 2-3/8 2-7/16	60	270	212	160	33	22	56	78	31	26	M27	UC312-36 312 312-38 312-39	FL312	6.1
UCFL313-40 313	2-1/2	65	295	240	175	33	25	58	78	31	30	M27	UC313-40 313	FL313	7.8
UCFL314-44 314	2-3/4	70	315	250	185	36	28	61	83	35	31	M30	UC 314-44 314	FL314	9.8
UCFL315 315-48	3	75	320	260	195	39	30	66	89	35	32	M30	UC315 315-48	FL315	11.3
UCFL316		80	355	285	210	38	32	68	90	38	34	M33	UC316	FL316	14.3
UCFL317-52 317	3-1/4	85	370	300	220	44	32	74	100	38	40	M33	UC317-52 317	FL317	16.0
UCFL318-56 318	3-1/2	90	385	315	235	44	36	76	100	38	40	M33	UC318-56 318	FL318	19.1
UCFL319 319-60	3-3/4	95	405	330	250	59	40	94	121	41	41	M36	UC319 319-60	FL319	24.6
UCFL320 320-64	4	100	440	360	270	59	40	94	125	44	42	M39	UC320 320-64	FL320	30.8
UCFL321		105	444	360	270	59	40	94	127	44	44	M39	UC321	FL321	27
UCFL322		110	474	390	300	60	42	96	131	44	46	M39	UC322	FL322	33
UCFL324		120	524	430	330	65	48	110	140	47	51	M42	UC324	FL324	48
UCFL326		130	554	460	360	65	50	115	146	47	54	M42	UC326	FL326	58
UCFL328		140	604	500	400	75	60	125	161	47	59	M45	UC328	FL328	81

11 | Insert Ball Bearing Units

Oval Flange Units

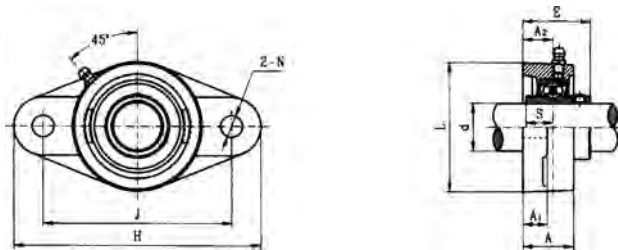

UCFT
 Eccentric locking collar type

UnitNo.	ShaftDia.		Dimensions(mm)										BoltSize	BearingNo.	Housing No.	Weight (kg)
	(in.)	(mm)	Da	H	J	L	A ₁	A ₂	A	E	N	S				
UCFT201		12	40	112	76.2	60	11	17.1	24.6	33	10.5		M10	UC201	FT201	0.39
UCFT202		15	40	112	76.2	60	11	17.1	24.6	33	10.5	11.5	M10	UC202	FT202	0.40
UCFT203		17	40	112	76.2	60	11	17.1	24.6	33	10.5	11.5	M10	UC203	FT203	0.39
UCFT204		20	47	112	89.7	60	11	14.3	24.6	32.6	10.5	12.7	M10	UC204	FT204	0.49
UCFT205		25	52	124	98.8	70	13	15.9	27	35.7	12.5	14.3	M10	UC205	FT205	0.68
UCFT206		30	62	141	116.7	83	13	17.9	30	40.1	12.5	15.9	M12	UC206	FT206	0.87
UCFT207		35	72	156	130.2	95	14	19.1	34	44.5	14	17.5	M12	UC207	FT207	1.32
UCFT208		40	80	171	143.7	105	14	21	38	51.2	14	19	M12	UC208	FT208	1.54
UCFT209		45	85	179	148.4	111	14	21.8	40	52	16	19	M12	UC209	FT209	1.73
UCFT210		50	90	189	157.2	116	14	22.2	40	54.6	16	19	M16	UC210	FT210	2.30
UCFT211		55	100	216	184.2	133	21	25.4	44	58.8	16	22.2	M16	UC211	FT211	2.77

11 | Insert Ball Bearing Units

Oval Flange Units

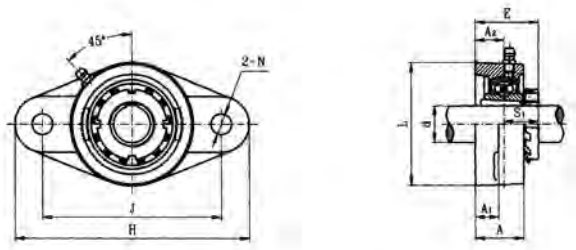

UKFL + H
Tapered bore, Adapter Bore

Unit No.	Shaft Dia.		Dimensions(mm)									Bolt Size	Bearing No.	Housing No	Adapter No.	Weight (kg)
	d (in.)	d (mm)	H	J	L	A ₂	A ₁	A	E	N	S ₁					
UKFL205+HE2305 205+H2305	3/4	20	130	99	68	16	13	27	34.5	16	18.5	M10	UK205	FL205	HE2305 H2305	0.6
UKFL206+HS2306 206+HA2306 206+H2306 206+HE2306	7/8 15/16 1	25	148	117	80	18	13	31	38.5	16	20.5	M10	UK206	FL206	HS2306 HA2306 H2306 HE2306	0.96
UKFL207+HS2307 207+H2307 207+HE2307	1-1/8 1-3/16	30	161	130	90	19	14	34	41.5	16	22.5	M12	UK207	FL207	HS2307 H2307 HE2307	1.3
UKFL208+HE2308 208+HS2308 208+H2308	1-1/4 1-3/8	35	175	144	100	21	14	36	45.5	16	24.5	M12	UK208	FL208	HE2308 HS2308 H2308	1.6
UKFL209+HA2309 209+HE2309 209+H2309	1-7/16 1-1/2	40	188	148	108	22	16	38	48	19	26	M16	UK209	FL209	HA2309 HE2309 H2309	2.0
UKFL210+HS2310 210+HA2310 210+HE2310 210+H2310	1-5/8 1-11/16 1-3/4	45	197	157	115	22	16	40	49.5	19	27.5	M16	UK210	FL210	HS2310 HA2310 HE2310 H2310	2.3
UKFL211+HS2311 211+HA2311 211+H2311 211+HE2311	1-7/8 1-15/16 2	50	224	184	130	25	18	43	53.5	19	28.5	M16	UK211	FL211	HS2311 HA2311 H2311 HE2311	3.3
UKFL212+HS2312 212+H2312	2-1/18	55	250	202	140	29	18	48	60	23	31	M16	UK212	FL212	HS2312 H2312	4.0
UKFL213+HA2313 213+HE2313 213+H2313 213+HS2313	2-3/16 2-1/4 2-3/8	60	258	210	155	30	20	50	62	23	32	M20	UK213	FL213	HA2313 HE2313 H2313 +HS2313	5.1
UKFL215+HA2309 215+HE2309 215+H2309	2-7/16 2-1/2	65	275	225	164	34	22	55	69.5	23	35.5	M20	UK215	FL215	HA2309 HE2309 H2309	6.4
UKFL216+HA2309 216+HE2309 216+H2309	2-11/16 2-3/4	70	290	233	180	34	22	58	73	25	39	M22	UK216	FL216	HA2309 HE2309 H2309	8.0

11 | Insert Ball Bearing Units

Oval Flange Units

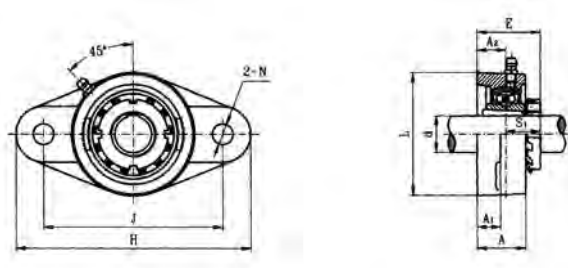

UKFL + H
 Tapered bore, Adapter Bore

Unit No.	Shaft Dia.		Dimensions(mm)									Bolt Size	Bearing No.	Housing No	Adapter No.	Weight (kg)
	d (in.)	d (mm)	H	J	L	A ₂	A ₁	A	E	N	S ₁					
UKFL305+HE2305 305+H2305	3/4	20	150	113	80	16	13	29	37.5	19	21.5	M16	UK305	FL305	HE2305 H2305	1.1
UKFL306+HE2306 306+HA2306 306+H2306 306+HE2306	7/8 15/16 1	25	180	134	90	18	15	32	41	23	23	M20	UK306	FL306	HE2306 HA2306 H2306 HE2306	1.5
UKFL307+HS2307 307+H2307 307+HE2307	1-1/8 1-3/16	30	185	141	100	20	16	36	45.5	23	25.5	M20	UK307	FL307	HS2307 H2307 HE2307	1.8
UKFL308+HE2308 308+HS2308 308+H2308	1-1/4 1-3/8	35	200	158	112	23	17	40	50.5	23	27.5	M20	UK308	FL308	HE2308 HS2308 H2308	2.5
UKFL309+HA2309 309+HE2309 309+H2309	1-7/16 1-1/2	40	230	177	125	25	18	44	55	25	30	M22	UK309	FL309	HA2309 HE2309 H2309	3.5
UKFL310+HS2310 310+HA2310 310+HE2310 310+H2310	1-5/8 1-11/16 1-3/4	45	240	187	140	28	19	48	60	25	32	M22	UK310	FL310	HS2310 HA2310 HE2310 H2310	4.4
UKFL311+HS2311 311+HA2311 311+H2311 311+HE2311	1-7/8 1-11/16 2	50	250	198	150	30	20	52	63.5	25	33.5	M22	UK311	FL311	HS2311 HA2311 H2311 HE2311	5.1
UKFL312+HS2305 312+HE2305	2-1/8	55	270	212	160	33	22	56	69.5	31	36.5	M27	UK312	FL312	HS2305 HE2305	6.0
UKFL313+HS2311 313+HA2311 313+H2311 313+HE2311	2-3/16 2-1/4 2-3/8	60	295	240	175	33	25	58	71.5	31	38.5	M27	UK313	FL313	HS2311 HA2311 H2311 HE2311	7.6

11 | Insert Ball Bearing Units

Round Flanged Cartridge Units

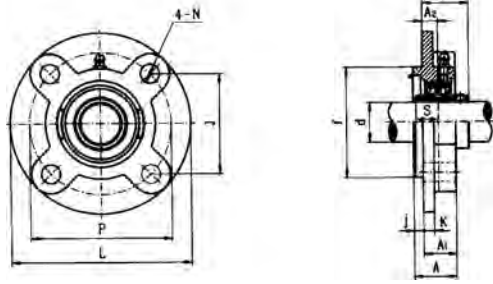

UCFC Set screw type

Unit No.	Shaft Dia.		Dimensions(mm)						Dimensions(mm)						Bolt Size	Bearing No.	Housing No.	Weight (kg)
	(in.)	(mm)	L	J	A ₂	A ₁	A	j	K	N	J	f	S	E				
UCFC 202 202-10 203 203-11 UCFC 204-12 204	3/4	20	100	78	10	20.5	25.5	5	6	12	55.1	62	12.7	28.3	M10	UC202 202-10 203 203-11 UC204-12 204	FC203 FC204	0.56 0.54 0.76
UCFC 205-14 205-15 205 205-16	7/8 15/16 1	25	115	90	10	21	27	6	7	12	63.6	70	14.3	29.8	M10	UC205-14 205-15 205 205-16	FC205	0.96
UCFC 206-18 206 206-19 206-20	1-1/8 1-3/16 1-1/4	30	125	100	10	23	31	8	8	12	70.7	80	15.9	32.2	M10	UC206-18 206 206-19 206-20	FC206	1.37
UCFC 207-20 207-21 207-22 207 207-23	1-1/4 1-5/16 1-3/8 1-7/16	35	135	110	11	26	34	8	9	14	77.8	90	17.5	36.4	M12	UC207-20 207-21 207-22 207 207-23	FC207	1.7
UCFC 208-24 208-25 208	1-1/2 1-9/16	40	145	120	11	26	36	10	9	14	84.8	100	19	41.2	M12	UC208-24 208-25 208	FC208	2.0
UCFC 209-26 209-27 209-28 209	1-5/8 1-11/16 1-3/4	45	160	132	10	26	38	12	10	16	93.3	105	19	40.2	M14	UC209-26 209-27 209-28 209	FC209	2.7
UCFC 210-30 210-31 210	1-7/8 1-15/16	50	165	138	10	28	40	12	14	16	97.6	110	19	42.6	M14	UC210-30 210-31 210	FC210	2.9
UCFC 211-32 211-34 211 211-35	2 2-1/8 2-3/16	55	185	150	13	30	42	12	13	19	106.1	125	22.2	46.4	M16	UC211-32 211-34 211 211-35	FC211	4.2
UCFC 212-36 212 212-38 212-39	2-1/4 2-3/8 2-7/16	60	195	160	17	36	48	12	15	19	113.1	135	25.4	56.7	M16	UC212-36 212 212-38 212-39	FC212	4.94
UCFC 213-40 213	2-1/2	65	205	170	16	35	49	14	15	19	120.2	145	25.4	55.7	M16	UC213-40 213	FC213	5.7
UCFC 214-44 214	2-3/4	70	215	177	17	38	52	14	16	19	125.1	150	30.2	61.4	M16	UC214-44 214	FC214	6.8
UCFC 215 215-48	3	75	220	184	18	39	55	16	17	19	130.1	160	33.3	62.5	M16	UC215 215-48	FC215	7.2
UCFC 216		80	240	200	18	42	58	16	18	23	141.4	170	33.3	67.3	M20	UC216	FC216	8.7
UCFC 217-52 217	3-1/4	85	250	208	18	45	63	18	20	23	147.1	180	34.1	69.6	M20	UC217-52 217	FC217	10.3
UCFC 218-56 218	3-1/2	90	265	220	22	50	68	18	20	23	155.5	190	39.7	78.3	M20	UC218-56 218	FC218	13.5

11 | Insert Ball Bearing Units

Round Flanged Cartridge Units

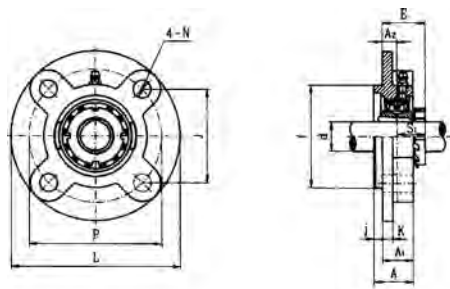

UKFC + H Tapered bored, adapter type

Unit No.	Shaft Dia.		Dimensions(mm)						Dimensions(mm)						Bolt Size	Bearing No.	Housing No	Adapter No.	Weight (kg)
	(in.)	(mm)	L	J	A ₂	A ₁	A	j	K	N	J	f	S	E					
UKFC205+HE2305 205+H2305	3/4	20	115	90	10	21	27	6	7	12	63.6	70	18.5	28.5	M10	UK205	FC205	HE2305 H2305	.98
UKFC206+HS2306 206+HA2306 206+H2306 206+HE2306	7/8 15/16 1	25	125	100	10	23	31	8	8	12	70.7	80	20.5	30.5	M10	UK206	FC206	HS2306 HA2306 H2306 HE2306	1.2
UKFC207+HS2307 207+H2307 207+HA2307	1-1/8 1-3/16	30	135	110	11	26	34	8	9	14	77.8	90	22.5	33.5	M12	UK207	FC207	HS2307 H2307 HA2307	1.7
UKFC208+HE2308 208+HS2308 208+H2308	1-1/4 1-3/8	35	145	120	11	26	36	10	9	14	84.8	100	24.5	35.5	M12	UK208	FC208	HE2308 HS2308 H2308	2.0
UKFC209+HA2309 209+HE2309 209+H2309	1-7/16 1-1/2	40	160	132	10	26	38	12	10	16	93.3	105	26	36	M14	UK209	FC209	HA2309 HE2309 H2309	2.7
UKFC210+H2310 210+HA2310 210+HE2310 210+H2310	1-5/8 1-11/16 1-3/4	45	165	138	10	28	40	12	14	16	97.6	110	27.5	37.5	M14	UK210	FC210	HS2310 HA2310 HE2310 H2310	3.0
UKFC211+HS2311 211+HAS2311 211+H2311 211+HE2311	1-7/8 1-15/16 2	50	185	150	13	30	42	12	13	19	106.1	125	28.5	41.5	M16	UK211	FC211	HS2311 HA2311 H2311 HE2311	4.2
UKFC212+HS2312 212+H2312	2-1/8	55	195	160	17	36	48	12	15	19	113.1	135	31	48	M16	UK212	FC212	HS2312 H2312	4.9
UKFC213+H2313 213+HE2313 213+H2313 213+HS2313	2-3/16 2-1/4 2-3/8	60	205	170	16	35	49	14	15	19	120.2	145	32	48	M16	UK213	FC213	HA2313 HE2313 H2313 HS2313	5.6
UKFC215+HA2315 215+HE2315 215+H2315	2-7/16 2-1/2	65	220	184	18	39	55	16	17	19	130.1	160	35.5	53.5	M16	UK215	FC215	HA2315 HE2315 H2315	7.5
UKFC216+HA2316 216+HE2316 216+H2316	2-11/16 2-3/4	70	240	200	18	42	58	16	18	23	141.4	170	39	57	M20	UK216	FC216	HA2316 HE2316 H2316	8.9
UKFC217+HA2317 217+H2317 217+HE2317	2-15/16 3	75	250	208	18	45	63	18	20	23	147.1	180	40	58	M20	UK217	FC216	HA2317 H2317 HE2317	10.4
UKFC218+H2318		80	265	220	22	50	68	18	20	23	155.5	190	42	64	M20	UK218	FC218	H2318	13.3

11 | Insert Ball Bearing Units

Take - Up Units

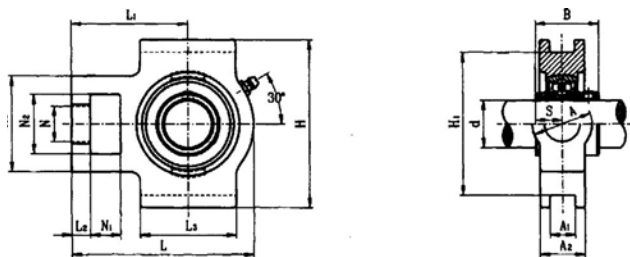

UCT Set screw type

Unit No.	Shaft Dia.		Dimensions(mm)/(in.)							Dimensions(mm)/(in.)								Bearing No.	Housing No.	Weight (kg)
	d (in.)	d (mm)	N ₁	L ₂	H ₂	N ₂	N	L ₃	A ₁	H ₁	H	L	A	A ₂	L ₁	B	S			
UCT204-12 204	3/4	20	16	10	51	32	19	51	12	76	89	94	32	21	61	31	12.7	UC204-12 204	T204	0.79
UCT205-14 205-15 205 205-16	7/8 15/16 1	25	16	10	51	32	19	51	12	76	89	97	32	24	62	34.1	14.3	UC205-14 205-15 205 205-16	T205	0.88
UCT206-18 206 206-19 206-20	1-1/8 1-3/16 1-1/4	30	16	10	56	37	22	57	12	89	102	113	37	28	70	38.1	15.9	UC206-18 206 206-19 206-20	T206	1.3
UCT207-20 207-21 207-22 207 207-23	1-1/4 1-5/16 1-3/8 1-7/16	35	16	13	64	37	22	64	12	89	102	129	37	30	78	42.9	17.5	UC207-20 207-21 207-22 207 207-23	T207	1.7
UCT208-24 208-25 208	1-1/2 1-9/16	40	19	16	83	49	29	83	16	102	114	144	49	33	88	49.2	19	UC208-24 208-25 208	T208	2.5
UCT209-26 209-27 209-28 209	1-5/8 1-11/16 1-3/4	45	19	16	83	49	29	83	16	102	117	144	49	35	87	49.2	19.0	UC209-26 209-27 209-28 209	T209	2.5
UCT210-30 210-31 210	1-7/8 1-15/16		19	16	83	49	29	83	16	102	117	144	49	37	90	51.6	19	UC210-30 210-31 210	T210	2.6
UCT211-32 211-34 211 211-35	2 2-1/8 2-3/16	50	25	19	102	64	35	95	22	130	146	171	64	38	106	55.6	22.2	UC211-32 211-34 211 211-35	T211	4.0
UCT212-36 212 212-38 212-39	2-1/4 2-3/8 2-7/16	60	32	19	102	64	35	102	22	130	146	194	64	42	119	65.1	25.4	UC212-36 212 212-38 212-39	T212	1.9
UCT213-40 213	2-1/2	65	32	21	111	70	41	121	26	151	167	224	70	44	137	65.1	25.4	UC213-40 213	T213	7.0
UCT214-44 214	2-3/4	70	32	21	111	70	41	121	26	151	167	224	70	46	137	74.6	30.2	UC214-44 214	T214	7.1
UCT215 215-48	3	75	32	21	111	70	41	121	26	151	167	224	70	48	140	77.8	33.3	UC215 215-48	T215	7.5
UCT216		80	32	21	111	70	41	121	26	165	184	235	70	51	140	82.6	33.3	UC216	T216	8.2
UCT217-52 217	3-1/4	85	38	29	124	73	48	157	30	173	198	260	73	54	162	85.7	34.1	UC217-52 217	T217	11.0

11 | Insert Ball Bearing Units

Take - Up Units

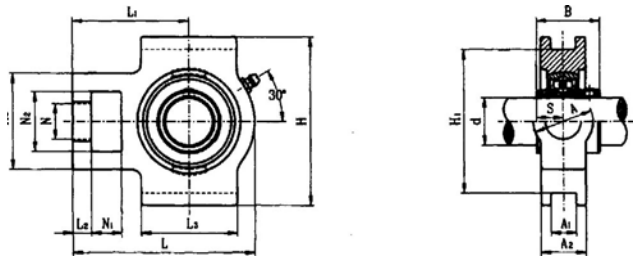

UCK Set screw type

Unit No.	Shaft Dia.	Dimensions(mm)							Dimensions(mm)								Bearing No.	Housing No.	Weight (kg)
	D (mm)	N ₁	L ₂	H ₂	N ₂	N	L ₃	A ₁	H ₁	H	L	A	A ₂	L ₁	B	S			
UCK204	20	16	10	51	32	19	51	13.5	76	89	94	32	24	61	31	12.7	UC204	K204	0.79
UCK205	25	16	10	51	32	19	51	13.5	76	89	97	32	26	62	34.1	14.3	UC205	K205	0.88
UCK206	30	16	10	56	37	22	57	13.5	89	102	113	37	30	70	38.1	15.9	UC206	K206	1.3
UCK207	35	16	13	64	37	22	64	13.5	89	102	129	37	32	78	42.9	17.5	UC207	K207	1.7
UCK208	40	19	16	83	49	29	83	17.5	101	114	144	49	33	88	49.2	19	UC208	K208	2.5
UCK209	45	19	16	83	49	29	83	17.5	101	117	144	49	35	88	49.2	19	UC209	K209	2.5
UCK210	50	19	16	83	49	29	86	17.5	101	117	149	49	37	90	51.6	19	UC210	K210	2.6
UCK211	55	25	19	102	64	35	95	27	130	146	171	64	42	106	55.6	22.2	UC211	K211	4
UCK212	60	31	17	102	64	35	102	27	130	146	193	64	50	119	65.1	25.4	UC212	K212	4.9

11 | Insert Ball Bearing Units

Take - Up Units

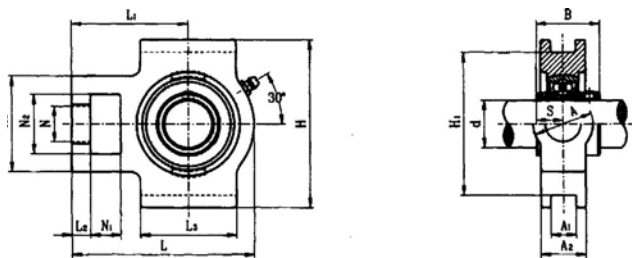

UCST Set screw type

Unit No.	Shaft Dia.		Dimensions(mm)							Dimensions(mm)								Bearing No.	Housing No.	Weight (kg)
	(in.)	(mm)	N ₁	L ₂	H ₂	N ₂	N	L ₃	A ₁	H ₁	H	L	A	A ₂	L ₁	B	S			
UCST204-12 204	3/4	20	16	10	51	32	19	51	13.5	76	89	94	32	21	61	31	12.7	UC204-12 204	ST 204	0.79
UCST205-14 205-15 205 205-16	7/8 15/16 1	25	16	10	51	32	19	51	13.5	76	89	96	32	24	62	34.1	14.3	UC205-14 205-15 205 205-16	ST 205	0.88
UCST206-18 206 206-19 206-20	1-1/8 1-3/16 1-1/4	30	16	10	56	37	22	57	13.5	89	102	113	37	28	70	38.1	15.9	UC206-18 206 206-19 206-20	ST 206	1.3
UCST207-20 207-21 207-22 207 207-23	1-1/4 1-5/16 1-3/8 1-7/16	35	16	13	64	37	22	64	13.5	89	102	129	37	30	78	42.9	17.5	UC207-20 207-21 207-22 207 207-23	ST 207	1.7
UCST208-24 208-25 208	1-1/2 1-9/16	40	19	16	83	49	29	83	17.5	102	114	144	49	33	88	49.2	19	UC208-24 208-25 208	ST 208	2.5
UCST209-26 209-27 209-28 209	1-5/8 1-11/16 1-3/4	45	19	16	83	49	29	83	17.5	102	117	144	49	35	87	49.2	19	UC209-26 209-27 209-28 209	ST 209	2.5
UCST210-30 210-31 210	1-7/8 1-15/16		19	16	83	49	49	86	17.5	102	117	149	49	37	90	51.6	19	UC210-30 210-31 210	ST 210	2.6
UCST211-32 211-34 211 211-35	2 2-1/8 2-3/16	50	25	19	102	64	35	95	27	130	146	171	64	38	106	55.6	22.2	UC211-32 211-34 211 211-35	ST 211	4.0
UCST212-36 212 212-38 212-39	2-1/4 2-3/8 2-7/16	60	32	19	102	64	35	102	27	130	146	194	64	42	119	65.1	25.4	UC212-36 212 212-38 212-39	ST 212	1.9

11 | Insert Ball Bearing Units

Flange Bracket Units

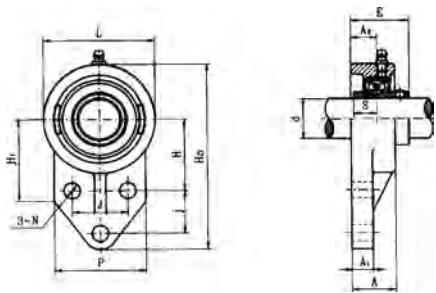

UCFB Set screw type

Unit No.	Shaft Dia.		Dimensions(mm)							Dimensions(mm)						Bolt Size	Bearing No.	Housing No.	Weight (kg)
	d (in.)	d (mm)	H ₁	L ₂	H ₁	P	H	j	J	A	A ₁	A ₂	N	E	S				
UCFB202 202-10 203 203-11 UCFB204-12 204	5/8 11/16 3/4	20	110	62	52	52	42	27	32	25.5	13	15	10	33.3	12.7	M8	UC202 202-10 203 203-11 UC204-12 204	FB203 FB204	0.42 0.41 0.62
UCFB205-14 205-15 205 205-16	7/8 15/16 1	25	116	68	52	56	45	27	34	27	13	16	10	35.8	14.3	M8	UC205-14 205-15 205 205-16	FB205	0.69
UCFB206-18 206 206-19 206-20	1-1/8 1-3/16 1-1/4	30	132	80	55	65	50	29	40	31	13	18	10	40.2	15.9	M8	UC206-18 206 206-19 206-20	FB206	0.93
UCFB207-20 207-21 207-22 207 207-23	1-1/4 1-5/16 1-3/8 1-7/16	35	144	90	62	70	55	32	46	33	14	19	10	44.4	17.5	M8	UC207-20 207-21 207-22 207 207-23	FB207	1.3
UCFB208-24 208-25 208	1-1/2 1-9/16	40	164	100	72	78	60	41	50	35	17	21	12	51.2	19	M10	UC208-24 208-25 208	FB208	1.8
UCFB209-26 209-27 209-28 209	1-5/8 1-11/16 1-3/4	45	175	108	76	80	65	43	54	38	16	22	12	52.2	19	M10	UC209-26 209-27 209-28 209	FB209	2
UCFB210-30 210-31 210 210-32	1-7/8 1-15/16 2	50	184	114	82	86	68	46	58	39	16	22	12	54.6	19	M10	UC210-30 210-31 210 210-32	FB210	2.3
UCFB211-32 211-34 211 211-35	2 2-1/8 2-3/16	55	207	128	86	90	78	50	62	42.5	18	25	14	58.4	22.2	M12	UC211-32 211-34 211 211-35	FB211	
UCFB212-36 212 212-38 212-39	2-1/4 2-3/8 2-7/16	60	224	140	90	94	84	55	66	47.5	19	29	14	68.7	25.4	M12	UC212-36 212 212-38 212-39	FB212	
UCFB213-40 213	2-1/2	65	244	152	95	102	92	60	70	49	20	30	14	69.7	25.4	M12	UC213-40 213	FB213	

11 | Insert Ball Bearing Units

Adjustable Flange Units

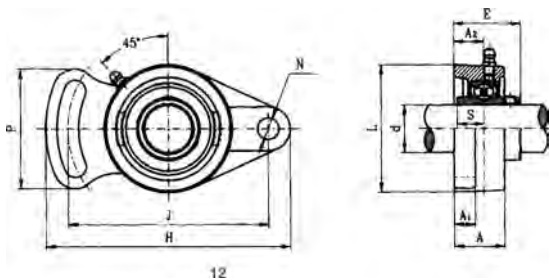

UCFA Set screw type

Unit No.	Shaft Dia.		Dimensions(mm)										Bolt Size	Bearing No.	Housing No.	Weight (kg)
	(in.)	d (mm)	H	J	L	P	A ₁	A ₂	A	N	E	S				
UCFA202 202-10 203 203-11 UCFA204-12 204	3/4	20	96	78	60	54	12	15	25.5	10	33.3	12.7	M8	UC202 202-10 203 203-11 UC204-12 204	FA 203	0.37 0.36
															FA 204	0.45
UCFA205-14 205-15 205 205-16	7/8 15/16 1	25	122	96	70	64	13	16	27	12	35.8	14.3	M8	UC205-14 205-15 205 205-16	FA 205	0.69
UCFA206-18 206 206-19 206-20	1-1/8 1-3/16 1-1/4	30	141	115	80	68	14	18	30.5	12	40.2	15.9	M8	UC206-18 206 206-19 206-20	FA 206	1.0
UCFA207-20 207-21 207-22 207 207-23	1-1/4 1-5/16 1-3/8 1-7/16	35	155	128	92	75	15	19	33	13	44.4	17.5	M8	UC207-20 207-21 207-22 207 207-23	FA 207	1.5
UCFA208-24 208-25 208	1-1/2 1-9/16	40	171	44	105	84	14	21	38	13	51.2	19	M10	UC208-24 208-25 208	FA 208	1.8
UCFA209-26 209-27 209-28 209	1-5/8 1-15/16 1-3/4	45	178	146	108	88	16	22	38	16	52.2	19	M10	UC209-26 209-27 209-28 209	FA 209	2.1
UCFA210-30 210-31 210 210-32	1-7/8 1-15/16 2	50	188	155	114	92	16	22	39	16	54.6	19	M10	UC210-30 210-31 210 210-32	FA 210	2.3
UCFA211-32 211-34 211 211-32	2 2-1/8 2-3/16	55	216	182	128	102	18	25	42.5	16	58.4	22.2	M12	UC211-32 211-34 211 211-32	FA 211	3.6
UCFA212-36 212 212-38 212-39	2-1/4 2-3/8 2-7/16	60	238	202	140	122	19	29	47.5	18	68.7	25.4	M12	UC212-36 212 212-38 212-39	FA 212	
UCFA213-40 213	2-1/2	65	248	210	152	126	20	30	49	18	69.7	25.4	M12	UC213-40 213	FA 213	

11 | Insert Ball Bearing Units

Hanger Units

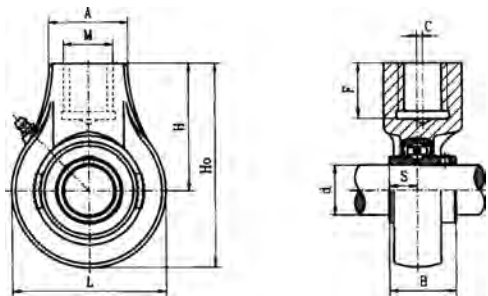

UCHA Set screw type

Unit No.	Shaft Dia.		Dimensions(mm)									Bearing No.	Housing No.	Weight (kg)
	(in.)	(mm)	H ₁	L	C	H	A	F	M	B	S			
UCHA203 203-11 UCHA204-12 204	3/4	20	96	64	0	64	40	19	G3/4	31	12.7	UC203 203-11 UC204-12 204	HA203 HA204	0.6 0.7
UCHA205-14 205-15 205 205-16	7/8 15/16 1	25	103	78	0	64	40	19	G3/4	34.1	14.3	UC205-14 205-15 205 205-16	HA205	0.88
UCHA206-18 206 206-19 206-20	1-1/8 1-3/16 1-1/4	30	103	78	0	64	40	19	G3/4	38.1	15.9	UC206-18 206 206-19 206-20	HA206	1.0
UCHA207-20 207-21 207-22 207 207-23	1-1/4 1-5/16 1-3/8 1-7/16	35	116	92	0	70	40	19	G3/4	42.9	17.5	UC207-20 207-21 207-22 207 207-23	HA207	1.2
UCHA208-24 208-25 208	1-1/2 1-9/16	40	121	96	2	73	40	19	G3/4	49.2	19	UC208-24 208-25 208	HA208	1.3
UCHA209-26 209-27 209-28 209	1-5/8 1-11/16 1-3/4	45	136	108	5	82	48	21	G1	49.2	19	UC209-26 209-27 209-28 209	HA209	1.8
UCHA210-30 210-31 210 210-32	1-7/8 1-15/16 2	50	140.5	115	5	83	48	21	G1	51.6	19	UC210-30 210-31 210 210-32	HA210	2.1
UCHA211-32 211-34 211 211-35	2 2-1/8 2-3/16	55	150	126	7	87	60	24	G1-1/4	55.6	22.2	UC211-32 211-34 211 211-35	HA211	2.8
UCHA212-36 212 212-38 212-39	2-1/4 2-3/8 2-7/16	60	173	142	9	102	60	28	G1-1/4	65.1	25.4	UC212-36 212 212-38 212-39	HA212	3.9
UCHA213-40 213	2-1/2	65	200	166	9.5	117	70	32	G1-1/2	65.1	25.4	UC213-40 213	HA213	5.9
UCHA214-44 214	2-3/4	70	200	166	9.5	117	70	32	G1-1/2	74.6	30.2	UC214-44 214	HA214	5.9
UCHA215-47 215 215-48	2-15/16 2	75	200	166	9.5	117	70	32	G1-1/2	77.8	33.2	UC215-47 215 215-48	HA215	5.9

11 | Insert Ball Bearing Units

Stainless Steel Ball Bearing Units

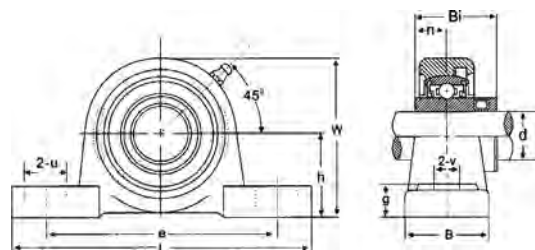

S.UCP200 Set screw type

Unit No.	Shaft Dia. (mm)	Dimensions(mm)										Bolt Size
		h	L	E	B	V	U	G	W	Bi	n	
S.UCP204	20	33.3	127	95	37	13	16	14	64	31	12.7	M10
S.UCP205	25	36.5	140	105	38	13	19	15	69.5	34	14.3	M10
S.UCP206	30	42.9	160	121	44	14	19	16	82	28.1	15.9	M12
S.UCP207	35	47.6	167	127	48	15	19	17	92	42.9	17.5	M12
S.UCP208	40	49.2	180	137	52	15	21	18	98	49.2	19	M12
S.UCP209	45	54	189	146	54	15	21	20	106	49.2	19	M12
S.UCP210	50	57.2	204	159	60	19	22	21	112	51.6	19	M16
S.UCP211	55	63.5	217	171	60	19	22	22	125	55.6	22.2	M16
S.UCP212	60	69.9	238	184	66	19	25	24	137	65.1	25.4	M16

Stainless Steel Square Flange Cast Blocks

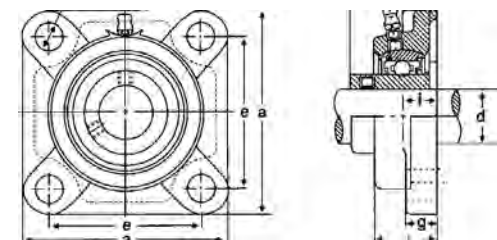

S.UCF 200 Series

Unit No.	Shaft Dia. (mm)	Dimensions(mm)/(in.)								Bolt Size
		a	e	i	g	l	s	Bi	n	
S.UCF204	20	86	64	15	11	25.5	12	31	12.7	M10
S.UCF205	25	95	70	16	13	27	12	34.1	14.3	M10
S.UCF206	30	108	83	18	13	31	12	38.1	15.9	M10
S.UCF207	35	117	92	19	15	34	14	42.9	17.5	M12
S.UCF208	40	130	102	21	15	36	16	49.2	19	M14
S.UCF209	45	137	105	22	16	38	16	49.2	19	M14
S.UCF210	50	143	111	22	16	40	16	51.6	19	M14
S.UCF211	55	162	130	25	18	43	19	55.6	22.2	M16
S.UCF212	60	175	143	29	18	48	19	65.1	25.4	M16

11 | Insert Ball Bearing Units

Two Bolt Flange Cast Housing

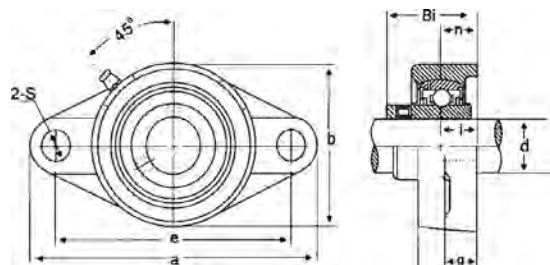

S.UCFL 200 Series

Unit No.	Shaft Dia. (mm)	Dimensions(mm)										Bolt Size
		a	e	i	g	l	s	b	Bi	n		
S.UCFL204	20	113	90	15	11	25.5	12	60	33.3	12.7	M10	
S.UCFL205	25	130	99	16	13	27	16	68	35.7	14.3	M14	
S.UCFL206	30	148	117	18	13	31	16	80	40.2	15.9	M14	
S.UCFL207	35	161	130	19	15	34	16	90	44.1	17.5	M14	
S.UCFL208	40	175	144	21	15	36	16	100	51.2	19	M14	
S.UCFL209	45	188	148	22	16	38	19	108	52.2	19	M16	
S.UCFL210	50	197	157	22	16	40	19	115	54.6	19	M16	
S.UCFL211	55	224	184	25	18	43	19	130	58.4	22.2	M16	
S.UCFL212	60	250	202	29	18	48	23	140	68.7	25.4	M20	

Taped Base Pillow Blocks

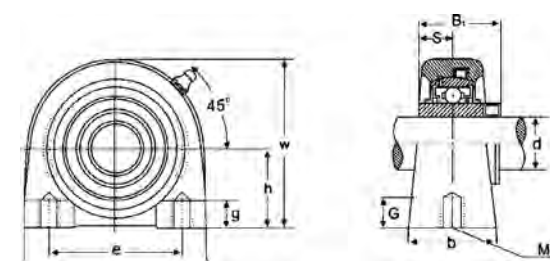

S.UCPA 200 Series

Unit No.	Shaft Dia. (mm)	Dimensions(mm)										Bolt Size
		h	a	e	b	G	g	w	Bi	S		
S.UCPA204	20	30.2	76	52	38	13	11	62	31.0	12.7	M10	
S.UCPA205	25	36.5	84	56	38	15	12	72	34.1	14.3	M10	
S.UCPA206	30	42.9	94	66	48	18	12	84	38.1	15.9	M14	
S.UCPA207	35	47.6	110	80	48	20	13	95	42.9	17.5	M14	
S.UCPA208	40	49.2	116	84	54	20	13	100	49.2	19.0	M14	
S.UCPA209	45	54.2	120	90	54	25	13	108	49.2	19.0	M14	
S.UCPA210	50	57.2	130	94	60	25	14	116	51.6	19.0	M16	
S.UCPA211	55	63.5	140	104	66	25	14	125	55.6	22.2	M16	
S.UCPA212	60	69.6	150	114	68	25	14	138	65.1	25.4	M16	

11 | Insert Ball Bearing Units

Take Up Units Cast Housing

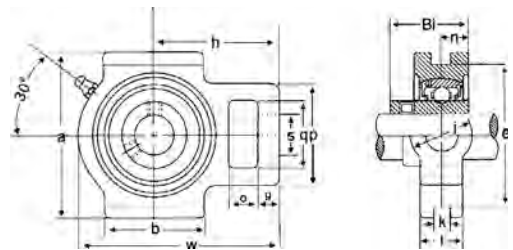

S.UCT 200 Series

Unit No.	Shaft Dia. (mm)	Dimensions(mm)														
		o	g	p	q	s	b	k	e	a	w	i	l	h	Bi	n
S.UCT204	20	16	10	51	32	19	51	12	76	89	94	32	21	61	31	12.7
S.UCT205	25	16	10	51	32	19	51	12	76	89	97	32	24	62	34.1	14.3
S.UCT206	30	16	10	56	37	22	57	12	89	102	113	37	28	70	38.1	15.9
S.UCT207	35	16	13	64	37	22	64	12	89	102	129	37	30	78	42.9	17.5
S.UCT208	40	19	16	83	49	29	83	16	102	114	144	49	33	88	49.2	19
S.UCT209	45	19	16	83	49	29	83	16	102	117	144	49	35	87	49.2	19
S.UCT210	50	19	16	83	49	29	86	16	102	117	149	49	37	90	51.6	19
S.UCT211	55	25	19	102	64	35	95	22	130	146	171	64	38	106	55.6	22.2
S.UCT212	60	25	19	102	64	35	102	22	130	146	194	64	42	119	65.1	25.4

Flange Cartridge Units Cast Housing

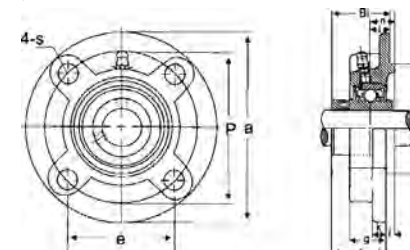

S.UCFC 200 Series

Unit No.	Shaft Dia. (mm)	Dimensions(mm)												Bolt Size
		a	p	e	i	s	j	k	g	f	z	Bi	n	
S.UCFC204	20	100	78	55.1	10	12	5	7	20.5	62	28.3	31	12.7	10
S.UCFC205	25	115	90	63.6	10	12	6	7	21	70	29.7	34.1	14.3	10
S.UCFC206	30	125	100	70.7	10	12	8	8	23	80	32.2	38.1	15.9	10
S.UCFC207	35	135	110	77.8	11	14	8	9	26	90	36.4	42.9	17.5	12
S.UCFC208	40	145	120	84.8	11	14	10	9	26	100	41.2	42.9	19	12
S.UCFC209	45	160	132	93.3	10	16	12	14	26	105	40.2	42.9	19	14
S.UCFC210	50	165	138	97.6	10	16	12	14	28	110	42.6	51.6	19	14
S.UCFC211	55	185	150	106.1	13	19	12	15	31	125	46.4	55.6	22.2	16
S.UCFC212	60	195	160	113.1	17	19	12	15	36	135	56.7	65.1	25.4	16

11 | Insert Ball Bearing Units

Stainless Steel Hange Units Cast Housing

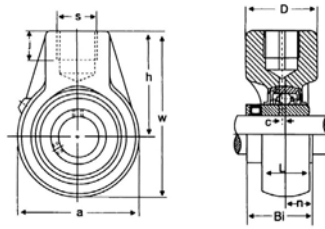

S.UCHA 200 Series

Unit No.	Shaft Dia. (mm)	Dimensions(mm)									
		a	w	h	D	S(in)	i	Bi	n	c	L
S.UCHA204	20	64	96	64	40	G3/4	19	31	12.7	0	21
S.UCHA205	25	70	103	64	40	G3/4	19	34.0	14.3	0	24
S.UCHA206	30	78	103	64	40	G3/4	19	38.1	15.9	0	28
S.UCHA207	35	92	116	70	40	G3/4	19	42.9	17.5	0	30
S.UCHA208	40	96	121	73	40	G3/4	19	42.9	19.0	2	33
S.UCHA209	45	108	136	82	48	G1	21	42.9	19.0	4	35
S.UCHA210	50	118	142	83	48	G1	21	51.6	19.0	5	37
S.UCHA211	55	126	150	87	60	G5/4	25	55.6	22.2	7	38
S.UCHA212	60	142	173	102	60	G5/4	26	65.1	25.4	9	42

Stainless Steel Three Hole Block

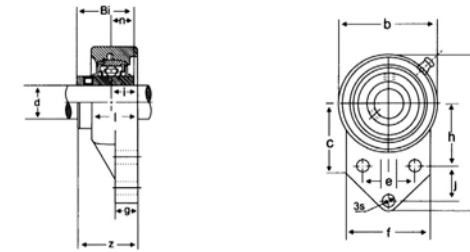

S.UCFB 200 Series

Unit No.	Shaft Dia. (mm)	Dimensions(mm)														Bolt size
		a	h	e	j	i	g	l	c	s	b	f	z	Bi	n	
S.UCFB204	20	110	42	32	27	15	13	25.5	52.0	10	62	52	33.3	31	12.7	M8
S.UCFB205	25	116	45	34	27	16	13	27.0	52	10	68	56	35.7	34.1	14.3	M8
S.UCFB206	30	130	50	40	29	18	13	31.0	55	10	78	65	40.2	38.1	15.9	M8
S.UCFB207	35	144	55	46	32	19	15	34.0	62	10	90	70	44.4	42.9	17.5	M8
S.UCFB208	40	164	60	50	41	21	16	36.0	72	12	100	78	51.2	49.2	19.0	M10
S.UCFB209	45	174	65	54	43	22	18	38.0	76	12	106	80	52.2	49.2	19.0	M10
S.UCFB210	50	184	68	58	46	22	18	40.0	82	12	112	86	54.6	51.6	19.0	M10

Estd. 1983

DPI[®]
BEARINGS

Plummer Blocks



11 | Plummer Blocks

Plummer Blocks Housing Series: SN 2

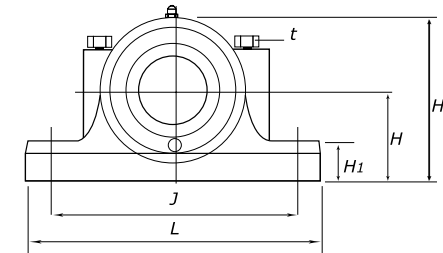

Boundary dimensions (mm)			Shaft Dia (mm)	Bearing No.	Weight (kg)
L	H	H2			
165	40	75	25	SN 205	1.10
185	50	90	30	SN 206	1.70
185	50	95	35	SN 207	1.90
205	60	110	40	SN 208	2.60
205	60	112	45	SN 209	2.80
205	60	115	50	SN 210	3.00
255	70	130	55	SN 211	4.50
255	70	135	60	SN 212	5.00
275	80	150	65	SN 213	5.60
275	80	155	70	SN 214	6.20
280	80	155	75	SN 215	7.00
315	95	175	80	SN 216	9.00
320	95	185	85	SN 217	10.00
345	100	195	90	SN 218	13.00
345	112	210	95	SN 219	15.00
380	112	223	100	SN 220	19.00
410	125	245	110	SN 222	20.00
410	140	270	120	SN 224	25.00
445	150	290	130	SN 226	30.00
500	150	305	140	SN 228	38.00
530	160	325	150	SN 230	46.00

11 | Plummer Blocks

Plummer Blocks Metric Dimensions Series: SN 5

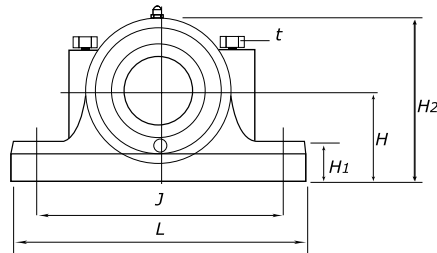

Boundary dimensions (mm)			Shaft Dia (mm)	Bearing No.	Weight (kg)
L	H	H2			
165	40	75	20	SN 505	1.200
185	50	90	25	SN 506	1.700
185	50	95	30	SN 507	2.000
205	60	110	35	SN 508	2.700
205	60	112	40	SN 509	2.900
205	60	115	45	SN 510	3.200
255	70	130	50	SN 511	4.200
255	70	135	55	SN 512	4.800
275	80	150	60	SN 513	5.600
280	80	155	65	SN 515	6.900
315	95	175	70	SN 516	8.800
320	95	185	75	SN 517	9.500
345	100	195	80	SN 518	13.000
345	112	210	85	SN 519	15.000
380	112	223	90	SN 520	19.000
410	125	245	100	SN 522	20.200
410	140	270	110	SN 524	23.200
445	150	290	115	SN 526	29.000
500	150	305	125	SN 528	36.500
530	160	325	135	SN 530	43.600

Plummer Blocks Housing Metric Dimensions Series: SN 6

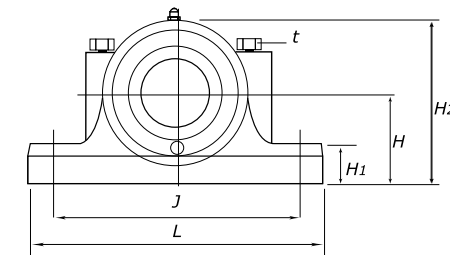

Boundary dimensions (mm)			Shaft Dia (mm)	Bearing No.	Weight (kg)
L	H	H2			
185	50	90	20	SN 605	1.6
185	50	95	25	SN 606	1.8
205	60	110	30	SN 607	2.6
205	60	115	35	SN 608	2.9
255	70	130	40	SN 609	4.1
255	70	135	45	SN 610	4.7
275	80	150	50	SN 611	5.8
280	80	155	55	SN 612	6.5
315	95	175	60	SN 613	8.7
345	100	195	65	SN 615	11.3
345	112	212	70	SN 616	12.6
380	112	223	75	SN 617	15.0
380	112	230	80	SN 618	22.0
410	125	250	85	SN 619	26.3
410	140	270	90	SN 620	31.5
450	150	300	100	SN 622	42.0
530	160	320	110	SN 624	60.0
550	170	340	115	SN 626	63.2
610	180	365	125	SN 628	94.5
650	190	385	135	SN 630	105.0

Special Products



12 | Special Products

Radial Insert Ball Bearings With Eccentric Locking Collar

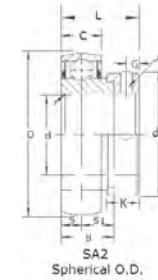

Boundary dimensions (mm)											Load rating (kN)		Bearing No.	Weight (kg)
<i>d</i>	<i>Be</i>	<i>D</i>	<i>B1</i>	<i>n</i>	<i>m</i>	<i>Bi</i>	<i>K</i>	<i>H</i>	<i>G</i>	<i>h</i>	Dynamic <i>C</i>	Static <i>Co</i>		
12	12	40	19.1	6	13	29	28.6	13.5	5	3.6	960	480	SA 201	0.13
15	12	40	19.1	6	13	29	28.6	13.5	5	3.6	960	480	SA 202	0.13
17	12	40	19.1	6	13	29	28.6	13.5	5	3.6	960	480	SA 203	0.13
20	14	47	21.5	7	15	31	33.3	13.5	5	3.9	1000	630	SA 204	0.15
25	15	52	21.5	7.5	14	31	38.1	13.5	5	3.9	1100	710	SA 205	0.22
30	16	62	23.8	8	16	36	44.5	15.9	6	5	1520	1020	SA 206	0.3
35	17	72	25.4	8.5	17	39	55.6	17.5	6.5	5.5	2010	1390	SA 207	0.5
40	18	80	30.2	9	21	44	60.3	18.3	6.5	6	2560	1810	SA 208	0.67
45	19	85	30.2	9.5	21	44	63.5	18.3	6.5	6.3	3300	2100	SA 209	0.73
50	20	90	30.2	10	20	44	69.9	18.3	6.5	6.5	3500	2300	SA 210	0.83
55	24	100	32.4	12	20	48	76.2	20.7	8	7.2	4400	3000	SA 211	0.87
60	24	110	33.4	12	21	53	84.2	22.3	8	8	4850	2960	SA 212	1.3

12 | Special Products

Spherical O.D. With Set Screws

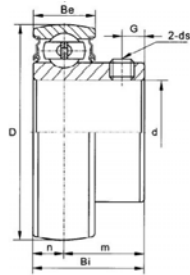

(mm)	Boundary dimensions (mm)							Load rating (kN)		Bearing No.	Weight (kg)
	Be	D	B1	n	m	G	h	Dynamic C	Static Co		
12	12	40	22	6.0	16.0	4.5	3.6	760	450	SB 201	0.10
15	12	40	22	6.0	16.0	4.5	3.6	760	450	SB 202	0.10
17	12	40	22	6.0	16.0	4.5	3.6	760	450	SB 203	0.10
20	14	47	25	7.0	18.0	4.5	3.9	1000	630	SB 204	0.15
25	15	52	27	7.5	19.5	5.5	3.9	1100	710	SB 205	0.18
30	16	62	30	8.0	22.0	5.5	5.0	1520	1020	SB 206	0.27
35	17	72	32	8.5	23.5	6.5	5.5	2010	1390	SB 207	0.42
40	18	80	34	9.0	25.0	7.0	6.0	2560	1810	SB 208	0.60
45	19	85	41.2	9.5	31.7	8.2	6.3	3260	2450	SB 209	0.80
50	20	90	41.6	10.0	31.6	9.2	6.5	3580	2300	SB 210	0.83
55	23	100	45.3	11.8	33.5	9.8	7.2	4400	2960	SB 211	1.1
60	24	110	53.7	14.9	38.8	9.8	8	4850	3300	SB 212	1.3

Spherical Radial Ball Bearings

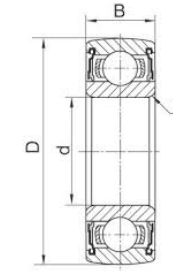

d	Boundary dimensions (mm)			Load rating (kN)		Bearing No.	Weight (kg)
	D	B	r	Dynamic C	Static Co		
12	32	10	0.6	6800	3050	CS201	0.039
15	35	11	0.6	7650	3720	CS202	0.039
17	40	12	0.6	9580	4780	CS203	0.050
20	47	14	1	12800	6650	CS204	0.095
25	52	15	1	14000	7880	CS205	0.11
	62	17	1.1	22200	11500	CS305	0.20
30	62	16	1	19500	11500	CS206	0.18
	72	19	1.1	27000	15200	CS306	0.30
35	72	17	1.1	25500	15200	CS207	0.25
	80	21	1.5	33200	19200	CS307	0.40
40	80	18	1.1	29500	18000	CS208	0.32
	90	23	1.5	40800	24000	CS308	0.55
45	85	19	1.1	31500	20800	CS209	0.37
	100	25	1.5	52800	31500	CS309	0.73
50	90	20	1.1	35000	23200	CS209	0.41
	100	27	2	61800	38000	CS309	0.95

12 | Special Products

Radial Spherical plain Bearings

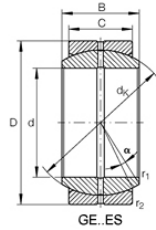

d	Boundary dimensions (mm)				dk	Load rating (kN)		Bearing No.	Weight (kg)
	D	B	C	Dynamic C		Static Co			
12	22	10	7	18	10.8	54.0	GE12ES	0.016	
15	26	12	9	22	17.0	85.0	GE15ES	0.025	
17	30	14	10	25	21.2	106	GE17ES	0.041	
20	35	16	12	29	30	146	GE20ES	0.061	
25	42	20	16	35.5	48	240	GE25ES	0.11	
30	47	22	18	40.7	62	310	GE30ES	0.14	
35	55	25	20	47	80	400	GE35ES	0.22	
40	62	28	22	53	100	500	GE40ES	0.30	
45	68	32	25	60	127	640	GE45ES	0.40	
50	75	35	28	66	156	780	GE50ES	0.54	
60	90	44	36	80	245	1220	GE60ES	1.0	
70	105	49	40	92	315	1560	GE70ES	1.5	
80	120	55	45	105	400	2000	GE80ES	2.2	
90	130	60	50	115	490	2450	GE90ES	2.7	
100	150	70	55	130	610	3050	GE100ES	4.3	
110	160	70	55	140	655	3250	GE110ES	4.7	
120	180	85	70	160	950	4750	GE120ES	8.0	
140	210	90	70	180	1080	5400	GE140ES	11.0	
160	230	105	80	200	1370	6800	GE160ES	13.5	

Radial Spherical plain Bearings

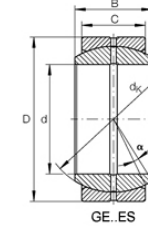

d	Boundary dimensions (mm)				dk	Load rating (kN)		Bearing No.	Weight (kg)
	D	B	C	Dynamic C		Static Co			
12	26.0	15	9	22	17.0	85.0	GEG12ES	0.034	
15	30	16	10	25	21.2	106	GEG15ES	0.046	
17	35	20	12	29	30.0	146.0	GEG17ES	0.078	
20	42	25	16	35.5	48	240	GEG20ES	0.015	
25	47	28	18	40.7	62	310	GEG25ES	0.19	
30	55	32	20	47	80	400	GEG30ES	0.29	
35	62	35	22	53	100	500	GEG35ES	0.39	
40	68	40	25	60	127	640	GEG40ES	0.52	
45	75	43	28	66	156	780	GEG45ES	0.68	
50	90	56	36	80	245	1220	GEG50ES	1.4	
60	105	63	40	92	315	1560	GEG60ES	2.0	
70	120	70	45	105	400	2000	GEG70ES	2.9	
80	130	75	50	115	490	2450	GEG80ES	3.5	
90	150	85	55	130	610	3050	GEG90ES	5.4	
100	160	85	55	140	655	3250	GEG100ES	5.9	
110	180	100	70	160	950	4750	GEG110ES	9.7	
120	210	115	70	180	1080	5400	GEG120ES	15	
140	230	130	80	200	1370	6800	GEG140ES	18.5	

12 | Special Products

Adapter assemblies for self-aligning Ball Bearings

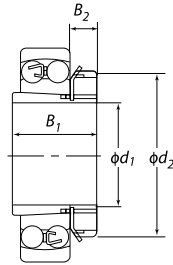

Bearing	Bearing Bore d	Boundary dimensions (mm)				ГОСТ	Adapter No.	Weight (kg)
		d_1	B_1	d_2	b_2			
1204K	20	17	24	32	7	H204	H204	0.041
1205K	25	20	26	38	8	H205	H205	0.070
1206K	30	25	27	45	8	H206	H206	0.099
1207K	35	30	29	52	9	H207	H207	0.125
1208K	40	35	31	58	10	H208	H208	0.174
1209K	45	40	33	65	11	H209	H209	0.227
1210K	50	45	35	70	12	H210	H210	0.274
1211K	55	50	37	75	12	H211	H211	0.308
1212K	60	55	38	80	13	H212	H212	0.346
1213K	65	60	40	85	14	H213	H213	0.401
1214K	70	60	41	92	14	H214	H214	0.593
1215K	75	65	43	98	15	H215	H215	0.707
1216K	80	70	46	105	17	H216	H216	0.882
1217K	85	75	50	110	18	H217	H217	1.020
1218K	90	80	52	120	18	H218	H218	1.190
1219K	95	85	55	125	19	H219	H219	1.370
1220K	100	90	58	130	20	H220	H220	1.490

Adapter assemblies for self-aligning Ball Bearings

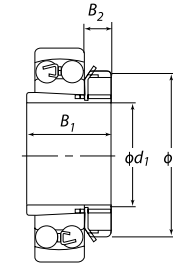

Bearing		Bearing Bore d	Boundary dimensions (mm)				ГОСТ	Adapter No.	Weight (kg)
			d_1	B_1	d_2	b_2			
2204K	1304K	20	17	28	32	7	H304	H304	0.045
2205K	1305K	25	20	29	38	8	H305	H305	0.075
2206K	1306K	30	25	31	45	8	H306	H306	0.109
2207K	1307K	35	30	35	52	9	H307	H307	0.142
2208K	1308K	40	35	36	58	10	H308	H308	0.189
2209K	1309K	45	40	39	65	11	H309	H309	0.248
2210K	1310K	50	45	42	70	12	H310	H310	0.303
2211K	1311K	55	50	45	75	12	H311	H311	0.345
2212K	1312K	60	55	47	80	13	H312	H312	0.394
2213K	1313K	65	60	50	85	14	H313	H313	0.458
2214K	1313K	70	60	52	92	14	H314	H314	0.723
2215K	1315K	75	65	55	98	15	H315	H315	0.831
2216K	1316K	80	70	59	105	17	H316	H316	1.030
2217K	1317K	85	75	63	110	18	H317	H317	1.180
2218K	1318K	90	80	65	120	18	H318	H318	1.370
2219K	1319K	95	85	68	125	19	H319	H319	1.560
2220K	1320K	100	90	71	130	20	H320	H320	1.690

12 | Special Products

Adapter Sleeves

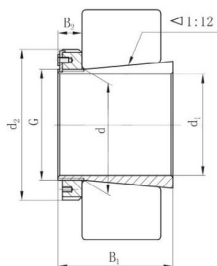

Boundary dimensions (mm)						Sleeve No.
dO	d	dZ	D	L	a	
20	25	M25*1.5	38	35	8	H2305
25	30	M30*1.5	45	38	8	H2306
30	35	M35*1.5	52	43	9	H2307
35	40	M40*1.5	58	46	10	H2308
40	45	M45*1.5	65	50	11	H2309
45	50	M50*1.5	70	55	12	H2310
50	55	M55*2	75	59	12	H2311
55	60	M60*2	80	62	13	H2312
60	65	M65*2	85	65	14	H2313
65	75	M75*2	98	73	15	H2315
70	80	M80*2	105	78	17	H2316
75	85	M85*2	110	82	18	H2317

Estd. 1983
DPI®
BEARINGS

Performance in Motion

•Range •Precision •Quality

Be Safe. Buy Original.

www.dpibearings.com



ویرا پرداز آروین پاسارگاد

با مدیریت خانم مهندس احمدی



جهت مشاوره

با کارشناسان فنی

با ما در ارتباط باشید



021 - 91001377



0935 125 90 98